

## Operating instructions

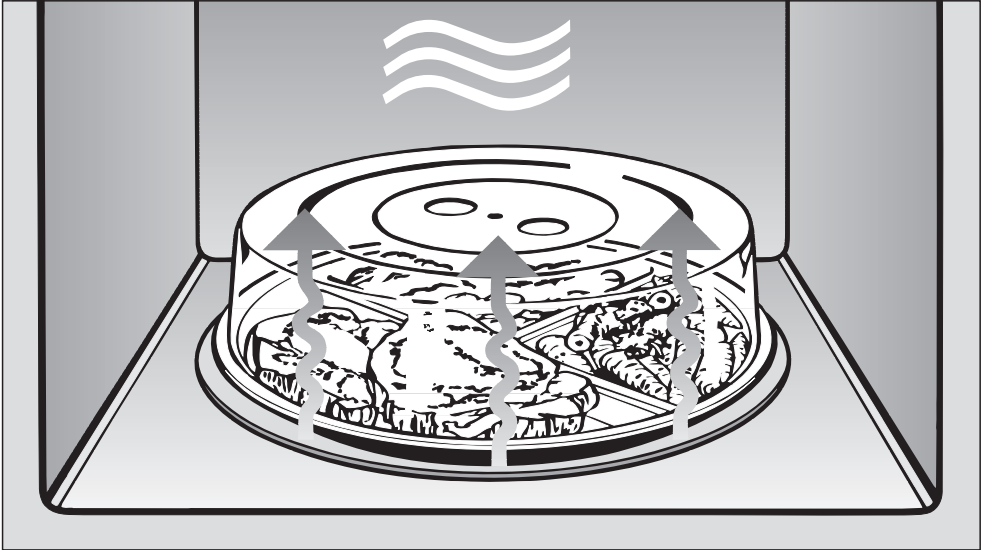

## Microwave oven M 8201-1

To avoid the risk of accidents or damage to the appliance it is **essential** to read these instructions before it is installed or used for the first time.

en - GB

M.-Nr. 09 472 770

# Contents

---

<b>Guide to the appliance</b> . . . . .	4
Oven interior and accessories . . . . .	4
Control panel . . . . .	5
Accessories supplied . . . . .	6
Grilling rack . . . . .	6
Glass tray . . . . .	6
Gourmet plate . . . . .	6
Cover . . . . .	6
Boiling rod . . . . .	6
<b>Caring for the environment</b> . . . . .	7
<b>Warning and Safety instructions</b> . . . . .	8
<b>How the microwave oven works</b> . . . . .	24
<b>Modes of operation</b> . . . . .	25
What can a microwave oven do? . . . . .	25
In what ways can a microwave oven be used? . . . . .	25
Microwave Solo mode . . . . .	25
Grill . . . . .	25
Combination mode (Microwave + Grill) . . . . .	25
Automatic programmes . . . . .	25
<b>Suitable containers for microwave ovens</b> . . . . .	26
Material and shape . . . . .	26
Testing dishes for their suitability . . . . .	28
The cover . . . . .	29
<b>Before using for the first time</b> . . . . .	30
<b>Time of day display</b> . . . . .	31
Setting the time of day . . . . .	31
Altering the time of day . . . . .	31
Switching off the time of day display . . . . .	31
Night time switch-off . . . . .	31
<b>Operation</b> . . . . .	32
To open the door . . . . .	32
Placing the dish in the oven . . . . .	32
Turntable . . . . .	32
To close the door . . . . .	32
Starting a programme . . . . .	32
"door" message . . . . .	33

Interrupting or re-starting a programme . . . . .	34
Altering the settings . . . . .	34
To cancel a programme . . . . .	34
At the end of a programme . . . . .	34
Automatic keep-warm function . . . . .	34
Quick start (programmable) . . . . .	35
System lock . . . . .	35
Minute minder . . . . .	36
Altering a minute minder entry . . . . .	36
Minute minder + cooking function . . . . .	36
<b>Operation - Grilling</b> . . . . .	37
<b>Gourmet plate</b> . . . . .	39
Use . . . . .	39
Some suggested uses . . . . .	40
Recipes . . . . .	40
<b>Operation - Automatic programmes</b> . . . . .	45
Automatic defrosting . . . . .	45
Automatic cooking . . . . .	45
<b>Recipes for Automatic programmes</b>  . . . . .	47
<b>Saving your favourite programme (Memory)</b> . . . . .	53
<b>Changing the settings</b> . . . . .	55
<b>Reheating</b> . . . . .	57
<b>Cooking</b> . . . . .	58
<b>Defrosting/Defrosting and reheating or cooking</b> . . . . .	59
<b>Some suggested uses</b> . . . . .	60
<b>Cleaning and care</b> . . . . .	61
Oven housing, interior and inside of the door . . . . .	61
Appliance front . . . . .	62
Accessories supplied . . . . .	63
<b>Problem solving guide</b> . . . . .	64
<b>After sales service</b> . . . . .	66
<b>Electrical connection</b> . . . . .	67
<b>Installation</b> . . . . .	69

# Guide to the appliance

## Oven interior and accessories

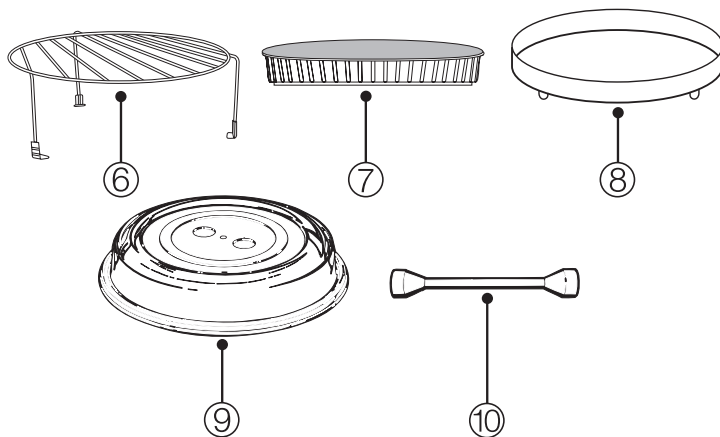
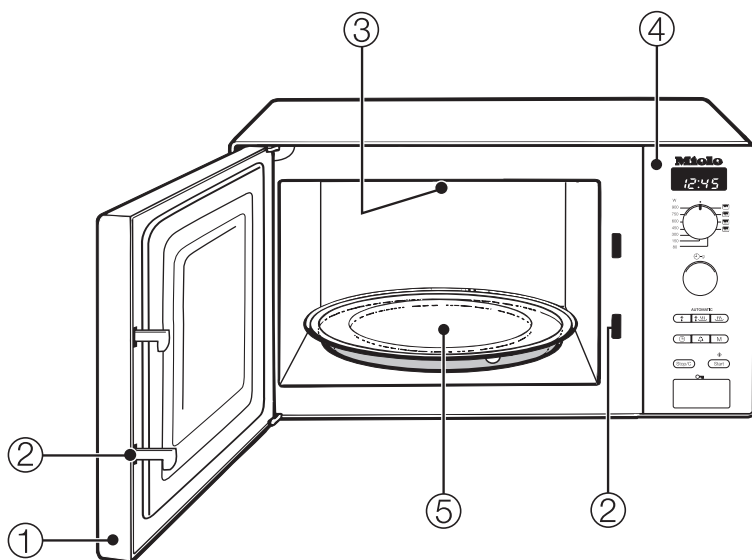

① Oven door

② Door locking mechanism

③ Quartz grill

④ Control panel

⑤ Turntable

⑥ Grilling rack

⑦ Glass tray

⑧ Gourmet plate

⑨ Cover

⑩ Boiling rod

## Control panel

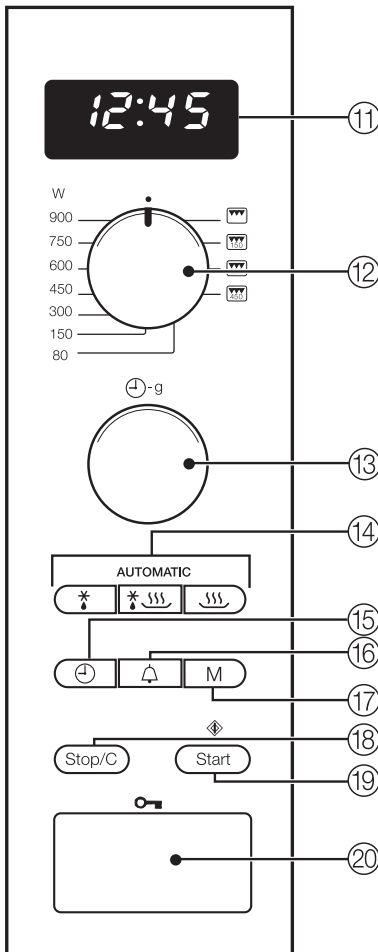

- ① Electronic timer and clock display
- ② Rotary selector for microwave power, grill and combination programmes
- ③ Rotary selector to enter time and weight
- ④ Automatic programme buttons
- ⑤ Time of day button  $\ominus$
- ⑥ Minute minder button  $\triangle$
- ⑦ Memory button (to save a 1-3 stage programme sequence)
- ⑧ Stop/cancel button
- ⑨ Start button/Add a minute button/Quick start button  $\diamond$  (programmable)
- ⑩ Door release  $\text{key}$

# Guide to the appliance

---

## Accessories supplied

### Grilling rack

The grilling rack can be used for all functions with and without microwave power, **except** for Microwave Solo mode.

To avoid the grilling rack being used inadvertently on Microwave Solo, it should not be kept inside the microwave oven.

### Glass tray

The glass tray is suitable for use with all cooking functions.

When grilling directly on the rack, the glass tray should be placed underneath the rack to catch any fat or juices.

### Gourmet plate

The gourmet plate is a round, non-stick grilling plate. It can be used to heat snacks or small meals quickly whilst maintaining crispness.

### Cover

The cover supplied must only be used in the Microwave Solo mode.

It prevents the food from drying out and the oven from becoming dirty, and it accelerates the heating process.

### Boiling rod

When heating liquids, the boiling rod provided should always be placed in the container. It helps liquids to heat evenly.

### Disposal of the packing material

The transport and protective packaging has been selected from materials which are environmentally friendly for disposal and should be recycled.

Ensure that any plastic wrappings, bags, etc are disposed of safely and kept out of the reach of babies and young children. Danger of suffocation.

### Disposal of your old appliance

Electrical and electronic appliances often contain materials which, if handled or disposed of incorrectly could be potentially hazardous to human health and to the environment. They are, however, essential for the correct functioning of your appliance. Please do not therefore dispose of it with your household waste.

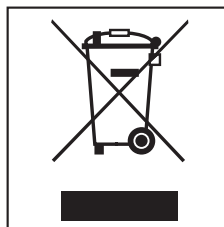

Please dispose of it at your local community waste collection / recycling centre or contact your dealer for advice. Ensure that it presents no danger to children while being stored for disposal.

## Warning and Safety instructions

---

This appliance complies with all relevant safety requirements. Inappropriate use can, however, present a risk of both personal injury and damage to property.

To avoid the risk of accidents and damage to the appliance, please read these instructions carefully before installation and before using it for the first time. They contain important information on its safety, installation, use and maintenance. Miele cannot be held liable for damage caused by non-compliance with these Warning and Safety instructions.

Keep these instructions in a safe place and ensure that new users are familiar with the content. Pass them on to any future owner.

### Correct application

► The appliance is not designed for commercial use. It is intended for use in domestic households and similar working and residential environments.

This appliance is not intended for outdoor use.

► It is intended for domestic use only to cook, defrost and to reheat and grill food. Any other use is not permitted.



## Warning and Safety instructions

---

- ▶ Do not use the appliance to store or dry items which could ignite easily. If such items were dried in the microwave oven the moisture in the item would evaporate causing it to dry out and even self-ignite.
- ▶ The appliance can only be used by people with reduced physical, sensory or mental capabilities, or lack of experience and knowledge, if they are supervised whilst using it, or have been shown how to use it in a safe way and understand the hazards involved.

### **Safety with children**

- ▶ Children under 8 years of age must be kept away from the appliance unless they are constantly supervised.
- ▶ Children 8 years and older may only use the appliance if they have been shown how to use it in a safe way and understand the hazards involved.
- ▶ Children must not be allowed to clean or maintain the appliance unsupervised.

## Warning and Safety instructions

---

- ▶ This appliance is not a toy! To prevent the risk of injury, do not let children play with the appliance or its controls.
- ▶ Danger of suffocation. Packaging, e.g. cling film, polystyrene and plastic wrappings, must be kept out of the reach of babies and children. Dispose of or recycle all packaging safely as soon as possible.
- ▶ Danger of burning. Children's skin is far more sensitive to high temperatures than that of adults. When grilling with or without the microwave function, the oven interior, the grill element and the oven door get hot. Great care should be taken to ensure that children do not touch the appliance when it is in use.

### Technical safety

- ▶ Check the appliance for visible signs of damage. Do not use a damaged appliance. It could be dangerous.
- ▶ If the electrical connection cable is faulty it must only be replaced by a Miele approved service technician to protect the user from danger.

## Warning and Safety instructions

---

- ▶ Operating a damaged appliance can result in microwave leakage and present a hazard to the user. Do not use the appliance if
  - the door is warped.
  - the door hinges are loose.
  - holes or cracks are visible in the casing, the door or the oven interior walls.
  
- ▶ Do not open the casing of the appliance. Tampering with electrical connections or components and mechanical parts is highly dangerous to the user and can cause operational faults.
  
- ▶ To avoid the risk of damage to the appliance, make sure that the connection data (fuse rating, frequency and voltage) on the data plate corresponds to the household supply before connecting the appliance to the mains supply. Consult a qualified electrician if in any doubt.
  
- ▶ Do not connect the appliance to the mains electricity supply by a multi-socket adapter or an extension lead. These do not guarantee the required safety of the appliance (e.g. danger of overheating).

## Warning and Safety instructions

---

► The electrical safety of this appliance can only be guaranteed when correctly earthed. It is most important that this basic safety requirement is observed and regularly tested, and where there is any doubt, the household wiring system should be inspected by a qualified electrician.

► To ensure adequate ventilation, a minimum gap of 5 cm is required between the appliance and any neighbouring furniture or walls. There must be a minimum gap of 19.5 cm between the top of the appliance and anything above it

► Repairs may only be carried out by a suitably qualified and competent person in strict accordance with national and local safety regulations. Repairs and other work by unqualified persons could be dangerous.

► While the appliance is under guarantee, repairs should only be undertaken by a service technician authorised by Miele. Otherwise the guarantee is invalidated.

► The appliance must be disconnected from the mains electricity supply during repair work, cleaning or maintenance.

## Warning and Safety instructions

---

- ▶ The manufacturer can only guarantee the safety of the appliance when Miele replacement parts are used. Faulty components must only be replaced by genuine Miele original spare parts.
- ▶ If the appliance is installed behind a kitchen furniture door, it may only be used with the furniture door open. Do not close the furniture door while the appliance is in use.
- ▶ The appliance must not be used in a non-stationary location (e.g. on a ship).
- ▶ In areas which may be subject to infestation by cockroaches or other vermin, pay particular attention to keeping the appliance and its surroundings in a clean condition at all times. Any damage which may be caused by cockroaches or other vermin will not be covered by the guarantee.

### Correct use

 Danger of burning. The microwave oven gets hot during grilling (with and without the microwave function). You could burn yourself on the oven interior, grill element, hot food, accessories and oven door. Use oven gloves when working with hot food in the oven or placing food in or removing it from the hot oven.

## Warning and Safety instructions

---

▶ Always ensure that food is sufficiently heated. Many factors will affect the overall cooking time, including the size and amount of food, its initial temperature, changes to the recipe, and the shape and size of the cooking container.

Some foods may contain micro-organisms which are only destroyed by thorough cooking. Therefore, when cooking or reheating foods, e.g. poultry, it is particularly important that food is fully cooked through (at temperatures over 70°C for more than 10 minutes). If in doubt select a longer cooking or reheating time.

▶ It is important that the heat is allowed to spread evenly throughout the food being cooked. This can be achieved by stirring and/or turning the food, and observing a sufficiently long standing time, which should be added to the time needed for cooking, reheating or defrosting.

▶ Exercise caution when cooking or reheating food with a high sugar content, e.g. Christmas pudding. If heated for too long, the sugar may caramelize or ignite.

## Warning and Safety instructions

---

- ▶ Always remember that times for cooking, reheating and defrosting in a microwave oven are usually considerably shorter than with traditional methods of food preparation.  
Excessively long cooking times can lead to food drying out and burning, or could even cause it to catch fire. Do not dry breadcrumbs, flowers, herbs, etc., in the microwave oven as these could catch fire.
- ▶ Do not use the microwave function to heat up cushions or pads filled with cherry kernels, wheat grains, lavender or gel, such as those used in aromatherapy. These pads can ignite when heated even after they have been removed from the microwave oven.
- ▶ The microwave oven is not suitable for cleaning or disinfecting items.  
Items can get extremely hot, and there is a danger of burning when the item is removed from the appliance. Fire hazard.
- ▶ The appliance can be damaged if it is used without food being placed in it or if it is incorrectly loaded. Therefore do not use the appliance to warm empty dishes or to dry herbs.

## Warning and Safety instructions

---

- ▶ Always ensure that food has been placed in the microwave oven and that the turntable is in position before switching on.
- ▶ Do not cook or reheat food or liquids in sealed containers, jars or bottles. With baby bottles, the screw top **and** teat must be loosened. Otherwise pressure builds up which can cause the bottle or container to explode, posing a severe risk of injury.
- ▶ Before serving, remember to allow a sufficient standing time and then always check the temperature of the food after taking it out of the microwave oven. The temperature of the container is not an indication of the temperature of the food or liquid in it. **This is particularly important when preparing food for babies, children, and the elderly or infirm.** Shake or stir baby milk and food thoroughly after heating, and try it for temperature to ensure that it will not scald the baby. When heating food and drinks, remember that the heat is created in the food itself and that the container will normally be cooler. The dish is only warmed by the heat of the food.



## Warning and Safety instructions

---

► When reheating liquids, place the boiling rod supplied into the cup or glass.



When heating liquids, milk, sauces etc, using microwave power without the boiling rod, the boiling point of the liquid may be reached without the production of typical bubbles. The liquid does not boil evenly throughout. This so-called 'boiling delay' can cause a sudden build-up of bubbles when the container is removed from the microwave oven or shaken, which can lead to the liquid boiling over suddenly and explosively. Danger of scalding and burning.

The formation of bubbles can be so strong that the pressure forces the microwave oven door open, with a danger of injury and damage.

## Warning and Safety instructions

---

- ▶ To avoid fuelling any flames, do not open the door if smoke occurs inside the microwave oven. Interrupt the process by switching the appliance off and disconnect it from the mains electricity supply. Do not open the door until the smoke has dispersed.
- ▶ Oil and fat can overheat and catch fire. Do not leave the appliance unattended when cooking with oil or fat. Do not use the appliance to fry food. If oil or fat does catch fire, do not attempt to put out the flames with water. Disconnect the appliance from the mains electricity supply and use a suitable fire blanket, saucepan lid, damp towel or similar to smother the flames.
- ▶ Due to the high temperatures radiated, objects left near the microwave oven when it is in use could catch fire. Do not use the appliance to heat up the room.
- ▶ If using alcohol in your recipes, please be aware that high temperatures can cause the alcohol to vaporise and even to ignite on hot surfaces. Do not heat undiluted alcohol in the appliance. Fire hazard.

## Warning and Safety instructions

---

- ▶ Do not use the appliance to heat up tins. Pressure can build up and they may explode.
- ▶ Cover any food which is left in the microwave oven to be kept hot, as moisture in the food could lead to corrosion damage in the appliance and could also damage the control panel, worktop and surrounding kitchen furniture. Covering the food also prevents it from drying out.
- ▶ Try to avoid the interior walls being splashed with food or liquids containing salt. If it does happen, wipe these away thoroughly to avoid corrosion on the stainless steel surface.
- ▶ The oven interior can get hot during use. Danger of burning. Clean the oven and any accessories as soon as they have cooled down. Waiting too long can make cleaning unnecessarily difficult and in some cases impossible. In certain circumstances, very heavy soiling can damage the appliance and even be dangerous. Fire hazard! Please follow the instructions on cleaning in "Cleaning and care".

## Warning and Safety instructions

---

► Fire hazard. Using microwave power with plastic dishes which are not microwave-safe can cause them to melt and damage the appliance.

Do not use any containers or cutlery made from or containing metal, aluminium foil, lead crystal glassware, temperature-sensitive plastics, wooden utensils or cutlery, metal clips or plastic or paper covered wire ties. Do not use bowls with milled rims, or plastic pots with the foil lid only partially removed (see "Suitable containers for microwave ovens"). Such items could be damaged or cause a fire hazard.

► Do not leave the microwave unattended when reheating or cooking food in disposable containers made of plastic, paper or other inflammable materials. Before using single-use containers make sure they are suitable for use in microwave ovens. See "Suitable containers for microwave ovens".

## Warning and Safety instructions

---

▶ Do not reheat food in the oven in heat-retaining bags intended for normal ovens. These heat-retaining bags usually contain a thin layer of aluminium foil which reflects microwaves. This reflected energy can, in turn, cause the outer paper covering to become so hot that it ignites.

▶ Eggs can be cooked without their shells using microwave power only if the yolk membrane has been punctured several times first. The pressure could otherwise cause the egg yolk to explode.

▶ Eggs can only be cooked in their shells in the microwave oven in a specially designed egg-boiling device available from specialist shops. Hard-boiled eggs should not be reheated in the microwave oven as this may lead to the eggs bursting even after they have been taken out of the appliance.

▶ Food with a thick skin or peel, such as tomatoes, sausages, jacket potatoes and aubergines, should be pierced or the skin cut in several places before cooking to allow steam to escape and prevent food from bursting.

## **Warning and Safety instructions**

---

- ▶ Dishes with hollow knobs or handles are not suitable for use with microwave power. Moisture which has gathered in the hollow recesses can cause pressure to build up and the item can explode. If the hollow recess is sufficiently ventilated, the item could be used. However, we recommend that you do not use such dishes in the microwave oven.
- ▶ To check the temperature of the food, first interrupt the cooking process. Only use a thermometer specifically approved for food use to measure the temperature of the food. Do not use a thermometer containing mercury or liquid, as these are not suitable for use with very high temperatures and break very easily.
- ▶ Do not use a steam cleaning appliance to clean the microwave oven. The steam could attack electrical components and cause a short circuit.

### **Stainless steel surfaces**

- ▶ The surface is susceptible to scratching. Even magnets can cause scratching.

### **Accessories**

- ▶ Only use genuine original Miele replacement parts. Using spare parts or accessories from other manufacturers will invalidate the guarantee, and Miele cannot accept liability.

## Warning and Safety instructions

---

▶ The rack and gourmet plate supplied are designed for use with microwave power and so can be used for grilling with or without the microwave function. They must not be used at the same time as this would damage the gourmet plate. Always place the gourmet plate directly on the turntable.

▶ The gourmet plate gets extremely hot when in use. Always use oven gloves when handling it to avoid burns. Place the hot gourmet plate on a suitable heat-resistant mat or pot rest. The rack gets hot during grilling (with and without the microwave function).  
Danger of burning.

▶ Do not use the cover with the gourmet plate, as the cover will get too hot.

▶ Do not place the hot glass tray (or any other hot cooking containers) on a cold surface, such as a tiled or granite worktop. The glass tray or container could crack or shatter. Use a suitable heat-resistant mat or pot rest.

### **Optional accessories:**

▶ If your microwave oven is built in with a lift-up door, do not bring the door down into the closed position when the oven is in operation.

# How the microwave oven works

---

In a microwave oven there is a high-frequency tube called a magnetron. This converts electrical energy into microwaves. These microwaves are distributed evenly throughout the oven interior, and rebound off the metal sides of the oven interior to reach the food from all sides. Microwave distribution is improved with the turntable engaged.

In order for microwaves to reach the food, they must be able to penetrate the cooking utensil being used. Microwaves can penetrate porcelain, glass, cardboard and plastics, but not metal. Do not, therefore, use utensils made of metal, or which contain metal, for example in the form of gold or silver trim. The metal reflects the microwaves and this could lead to the creation of sparks. The microwaves cannot be absorbed.

Microwaves pass through a suitable container and find their way directly into the food. All food contains moisture molecules which, when subjected to microwave energy, start to oscillate 2.5 thousand million times a second. The friction caused by this vibration creates heat, which first starts developing around the outside of the food and then slowly penetrates towards the centre. The moisture, fat and sugar content of food will affect the speed at which it is cooked.

As heat is produced directly in the food,

- food can generally be cooked without adding much liquid or cooking oil.

- cooking, reheating and defrosting in a microwave oven is quicker than using conventional methods.
- nutrients, such as vitamins and minerals, are generally retained.
- the colour, texture and taste of food are not impaired.

Microwaves stop being produced as soon as the cooking process is interrupted or the appliance door is opened.

When the appliance is in operation, the closed, sealed door prevents microwaves escaping from the appliance.



## What can a microwave oven do?

In the microwave oven, food can be cooked, reheated or defrosted quickly.

You can use the microwave in the following ways:

- Food can be defrosted, reheated or cooked by entering a power setting and a duration.
- Deep-frozen, ready-made meals can be defrosted and then reheated or cooked.
- The microwave oven can also be used for other tasks, e.g. for proving dough, melting chocolate and butter, dissolving gelatine etc.

## In what ways can a microwave oven be used?

### Microwave Solo mode

Suitable for defrosting, reheating and cooking.

### Grill

Ideal for grilling very thin cuts of meat, e.g. bacon.

### Combination mode (Microwave + Grill)

Ideal for browning dishes with toppings. The microwave cooks the food, and the grill browns it.

### Automatic programmes

You can choose from the following Automatic programmes:

- Five defrosting programmes  
(☼: Ad 1 to Ad 5),
- Four cooking programmes for frozen food  
(☼ ☺☺☺: AC 1 to AC 4)
- and eight cooking programmes for fresh food  
(☺☺☺: AC 1 to AC 8).

These programmes are weight dependent. You enter the weight of the food and then the cooking duration is calculated automatically.

The weight of the food can be displayed as metric (g) or imperial (lb). See "Changing the settings"

# Suitable containers for microwave ovens

## Microwaves

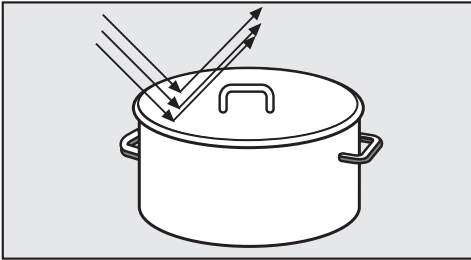

- are reflected by metal,

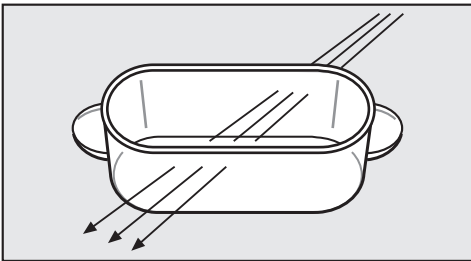

- pass through glass, porcelain, plastic and card,

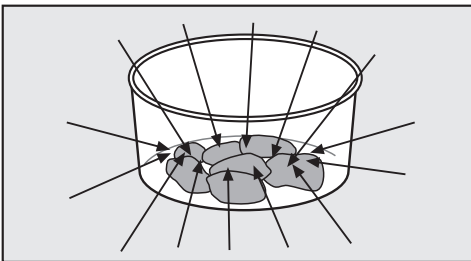

- and are absorbed by food.

## Material and shape

The material and shape of containers used affect cooking results and durations. Heat distribution is more even in round and oval shaped flat containers than in rectangular containers, providing better results.

Containers and lids with hollow handles or knobs in which moisture can collect are unsuitable, unless the hollowed handles are adequately vented. Without vent holes, pressure can build up, causing the container to crack or shatter with the danger of injury.

## Metal

Metal containers, aluminium foil, metal cutlery, and china with metallic decoration such as gold rims or cobalt blue must not be used on microwave mode. Metal reflects microwaves and obstructs the cooking process. Also, avoid using plastic pots where the foil lid has not be completely removed.

Exceptions:

- Ready-meals in aluminium foil dishes.

These can be defrosted and reheated in the microwave oven, if recommended by the manufacturer. Important: Remove the lid and make sure the foil dish is at least 2 cm from the oven walls at all times.

As food is only heated from the top, it is better to remove the food from the aluminium foil container and transfer it to a dish suitable for a microwave oven. The heat distribution will be more even.

# Suitable containers for microwave ovens

---

Do not place aluminium foil dishes on the rack in case the dish sparks or arcs. If sparks occur, transfer food to a microwave-safe container.

- Pieces of aluminium foil

For even defrosting and to avoid overcooking unevenly shaped cuts of meat, poultry or fish, small pieces of aluminium foil may be used to mask wingtips or other thin parts for the last few minutes of the programme.

Make sure that the aluminium foil is at least 2 cm from the oven walls at all times. It must not touch the walls.

- Metal meat skewers or clamps

These should only be used if they are very small in comparison to the size of the cut of meat.

## Glassware

Heat-resistant glass or ceramic glass are ideal for use in the microwave oven.

Crystal glass is unsuitable as it contains lead which could cause the glass to crack in the microwave oven.

## Porcelain

Porcelain is a suitable material.

Do not use porcelain with gold or silver edging or items with hollow knobs or handles, as insufficient ventilation may cause pressure.

## Earthenware

Decorated earthenware is only suitable if the decoration is beneath an all-over glaze.

Earthenware can get very hot and may crack.

## Glazes and colours

Some glazes and colours contain metals which make them unsuitable for use in a microwave oven.

## Wood

Wooden dishes are not suitable. Moisture contained in the wood evaporates when exposed to microwave energy, causing the wood to dry and crack.

## Plastics

When purchasing plasticware, make sure that it is suitable for use in a microwave oven.

Plastics must only be used with Microwave Solo.

They must be heat-resistant to a minimum of 110°C. Otherwise the plastic may melt and fuse with the food.

Special plastic utensils designed for use in microwave ovens are available from good retail outlets.

Melamine is not suitable as it absorbs energy and heats up.

# Suitable containers for microwave ovens

---

Disposable containers, such as trays made from polystyrene, can only be used for very short, timed warming and reheating of food.

Plastic boiling bags can be used for cooking and reheating. They should be pierced beforehand so that steam can escape. This prevents a build-up of pressure and reduces the risk of the bag bursting. There are also special steaming bags available which do not need to be pierced. Please follow instructions given on the packet.

Do not use metal clips, plastic clips containing metal parts, or paper ties containing wire. There is a danger that they will ignite when heated.

## Disposable containers

Only those plastic disposable containers which are specified by the manufacturer as suitable for use in a microwave oven may be used.

Do not leave the oven unattended when reheating or cooking food in disposable containers made of plastic, paper or other inflammable materials.

Disposable containers are not always recyclable or biodegradable.

## Testing dishes for their suitability

If in doubt as to whether glass, earthenware or porcelain plates or dishes are suitable for use in a microwave oven, a simple test can be performed:

- Place the item you wish to test in the centre of the oven, fill a suitable glass with water and also place this in the oven.
- Close the door.
- Turn the power selector to 900 W.
- Enter a duration of 30 seconds with the time selector.
- Press the Start button.

At the end of the test, the water in the glass should be warm and the dish cool. If the dish is hot and the water cold, it would be unwise to use the dish.

If a crackling noise is heard accompanied by sparks during the test, switch the appliance off immediately (press Stop/C button twice).

Any crockery which causes this reaction is unsuitable for use with microwave power.

If any doubt exists about the suitability of containers, please contact the supplier.

This test cannot be used to check whether items with hollow knobs or handles are suitable for use with microwave power.

# Suitable containers for microwave ovens

## The cover

- prevents too much steam escaping, especially when cooking foods which need longer to cook such as potatoes.
- speeds up the cooking process.
- prevents food from drying out.
- helps keep the oven interior clean.



Always cover food with the cover supplied.

Alternatively, use lids or covers made of microwave-safe glass or plastic, or use a clingfilm recommended for use in a microwave oven (pierce as instructed by the manufacturer).

Heat can cause normal clingfilm to distort and fuse with the food.

Sealed glass containers, such as jars of baby food, must be opened before they are placed in the oven.

## Do not use a lid or cover if

- food coated with breadcrumbs is being cooked.
- cooking meals which are to be given a crisp finish.
- the gourmet plate is being used.

Because the cover can only withstand temperatures of up to 110°C, it must only be used in Microwave Solo mode. It must not be used in conjunction with the gourmet plate. At temperatures in excess of 110°C, the plastic can melt and fuse with the food.

The cover should not form a seal with the container. If the cover is used with a container which only has a narrow diameter, there might not be enough room for condensation to escape through the holes in the top. The cover could get too hot and could start to melt.

## Before using for the first time

### Important:

After unpacking, let the appliance stand for approx. 2 hours at room temperature after transporting it to its final location before connecting it to the mains.

This is important for the correct electronic functioning of the appliance.

- Remove all the packaging materials and any protective foil from the appliance.

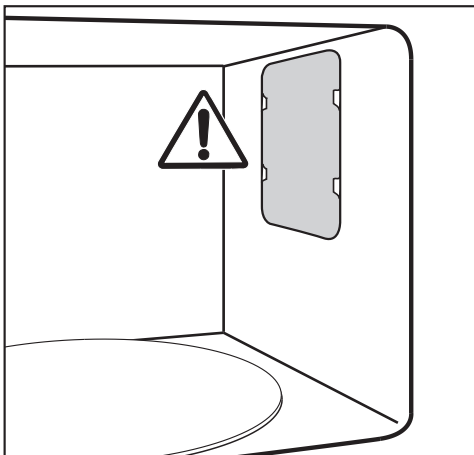

Do not remove the cover to the microwave outlet inside the oven, nor the film covering the inside of the door.

- Check the appliance for any damage.

Do not use the microwave if

- the door is warped.
- the door hinges are loose.
- holes or cracks are visible in the casing, the door or the oven interior walls.

Operating the appliance with this type of damage will result in microwave leakage and present a hazard to the user.

- Clean the inside of the oven and all the accessories with warm water applied with a well wrung-out soft sponge or cloth.

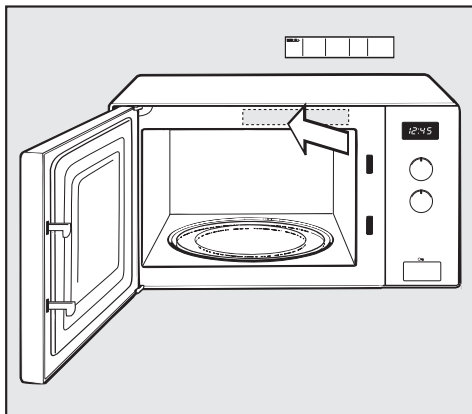

- Stick the enclosed short instructions to the frame behind the door as illustrated, making sure they do not block any of the vents.

## Setting the time of day

- Connect the appliance to the mains electricity supply.  
12:00 and the ☰ symbol will flash in the display until the current time of day is set. Before this, the time of day will start to run from 12:00, as the clock will start as soon as the appliance is connected to the mains electricity supply.

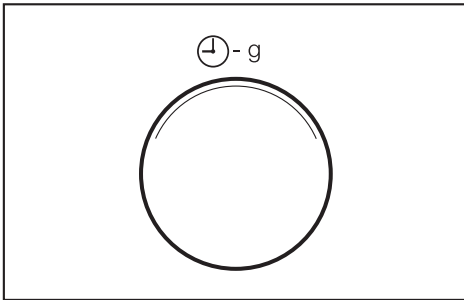

- Turn the time selector to set the hour.
- Press the ☰ button.
- Then turn the time selector to set the minutes.
- Press the ☰ button to confirm, or wait a few seconds.  
The set time is now registered. The colon between hours and minutes flashes.

## Altering the time of day

- Press the ☰ button.  
The ☰ symbol will flash in the display, and the current hour will light up for a few seconds.
- Use the time selector to alter the hour.

- Press the ☰ button to confirm, or wait a few seconds.  
The ☰ symbol will flash, and the current minutes will light up for a few seconds.
- Use the time selector to alter the minutes.
- Press the ☰ button to confirm, or wait a few seconds.

## Switching off the time of day display

- Press and hold the ☰ button in until the display goes dark.

Pressing and holding the ☰ button again will bring the time of day back in the display.

## Night time switch-off

The time of day display can be set to switch itself off from 23:00 hrs until 04:00 hrs.

## Setting the time of day display to switch off at night

- Press and hold in the Stop/C button, and at the same time press the ☰ button.

*ON* appears in the display.

The appliance can still be operated.

## To switch the display back on:

- Press and hold the Stop/C button, and at the same time press the ☰ button.

*OFF* appears in the display.

# Operation

## To open the door

- Press the  button to open the door.

If the microwave oven is being used, opening the door will interrupt the cooking programme.

## Placing the dish in the oven

Ideally the dish should be placed in the middle of the oven.

## Turntable

The turntable helps the food to cook, reheat or defrost evenly.

Do not operate the microwave oven without the turntable in place.

The turntable starts turning automatically when the appliance is operated.

Do not cook, reheat or defrost food directly on the turntable. Check that the dish is not larger in size than the turntable.

Stir the food during cooking, or turn the dish so that it heats up evenly.

## To close the door

- Push the door firmly shut.

Press the Start button again to resume an interrupted cooking programme.

The appliance will not start again if the door has not been closed properly.

## Starting a programme

Use the appropriate selector to choose the microwave power level and the cooking duration.

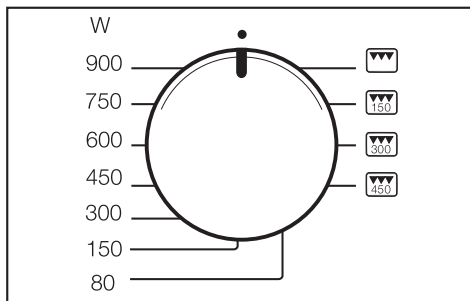

- Use the power selector to select a microwave power level.  
The  symbol and the power level selected light up in the display and 0:00 flashes.

There is a choice of 7 power levels. The higher the power level, the more microwaves reach the food.



When heating up food which cannot be stirred or turned during cooking, as with a plated meal, it is best to use a lower microwave power level.

This ensures the heat is distributed evenly. Heat for long enough to cook the food properly.

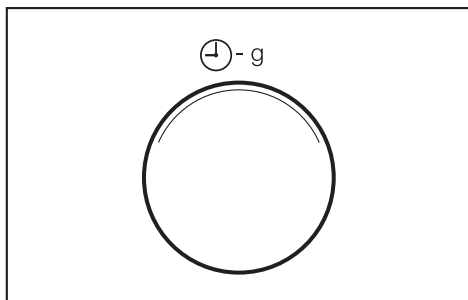

- Set the required duration using the time selector.

Any time between 10 seconds and 90 minutes can be selected.

Exception: if the maximum microwave power is selected, a maximum cooking duration of 15 minutes can be set. If you then continue to select full power, the power level may reduce to 600 W, and this is shown in the display (protection against overheating).

The duration required depends on:

- the initial temperature of the food.  
Food taken from the refrigerator will need longer to reheat or cook than food already at room temperature.
- the type and texture of the food.  
Fresh vegetables contain more water and cook more quickly than stored vegetables.

- the frequency of stirring or turning the food.  
Frequent stirring or turning heats the food more evenly, and it is therefore ready in a shorter time.

- the amount of food.

As a general rule, allow approx. time and a half for double the quantity.

For a smaller quantity, possibly shorten the time but ensure food is cooked thoroughly.

- the shape and material of the container.

- Press the Start button to start the programme.  
The interior lighting comes on.

A programme can only be started if the door is closed.

## "door" message

The "door" message in the display is a reminder that the appliance should not be used without food inside it.

Operating the appliance without food can damage the appliance.

If the door has been closed for 20 minutes or longer when the Start button is pressed, the word **door** will appear in the display to remind you to open the door and make sure there is food in the oven before you press Start. You cannot start a process until you do this.

# Operation

---

## Interrupting or re-starting a programme

At any time you can . . .

### . . . interrupt a programme:

- Press the Stop/C button or open the appliance door.

The time stops counting down.

### . . . continue the programme:

- Close the door and press Start.

The programme continues.

## Altering the settings

If you discover after starting a programme that . . .

. . . the **microwave power level** is too high or too low, you can

- select a new level.

. . . the **duration** set is too short or too long, you can

- interrupt the programme (press the Stop/C button once), use the time selector to set a new duration and continue the programme (press the Start button),

or alternatively:

- the cooking duration can be increased by pressing the Start button during operation. Each time the Start button is pressed, the cooking duration is increased by another minute. (Exception: the increased cooking duration is in increments of 30 seconds when the microwave is being used on maximum power.)

## To cancel a programme

- Press the Stop/C button twice.

## At the end of a programme

An audible tone will sound when the cooking programme is complete. The interior lighting goes out.

The audible tone will sound briefly as a reminder every 5 minutes for 20 minutes after the end of the programme.

- If you want to stop the audible tone, press the Stop/C button.

## Automatic keep-warm function

The keep-warm function will switch on automatically at 80 W for a maximum of 15 minutes approx. 2 minutes after the end of a cooking programme which has used at least 450 W, providing the door remains closed and no buttons are pressed.

 80 W and **H:H** will light up in the display.



Opening the door or operating one of the buttons or selectors while the keep-warm function is in progress cancels the function.

The keep-warm function cannot be set as a separate function.

## Quick start (programmable)

Pressing the Start button  is sufficient to set the appliance operating on maximum power.

Three set durations are stored in the memory:



- 30 secs: Press Start  once
- 1 min: Press Start  twice
- 2 min: Press Start  three times

Pressing the Start  button four times in succession will bring back the first stored duration and so on.

The cooking duration can be increased by pressing the Start button during operation; each time the Start button is pressed, the cooking duration is increased by another 30 seconds.

## Programming durations

To alter the set durations:

- Use the Start  button to select the duration you want to reprogramme (press once, twice or three times), and hold the Start  button pressed in.
- While holding the Start button pressed in, alter the duration with the time selector (to max. 15 minutes). The altered programme runs when the Start  button is released.

An interruption to the power supply will cancel any altered programmed durations, and they will need to be entered again.

## System lock

The system lock prevents the appliance being used by children, for example.

### To activate the system lock

- Press and hold the Stop/C button in until an audible tone sounds and the key symbol appears in the display:



The key symbol will go out after a short time.

The key symbol reappears whenever any button or one of the rotary selectors is operated.

After an interruption to the mains power supply, the system lock will need to be re-activated.

### To cancel the system lock





- Press the Stop/C button again and hold it pressed in until an audible tone sounds.

# Operation

---

## Minute minder

The minute minder can be used to time any activity in the kitchen, e.g. boiling eggs. The time set counts down in one second steps.



- Press the  button.  
0:00 flashes in the display and the  symbol lights up.
- Use the time selector to set the minute minder time you require.
- Press the Start button to start the minute minder.  
The minute minder time will start itself after a few seconds if the Start button is not pressed.
- At the end of the minute minder time, an audible tone sounds. The time of day reappears and the  symbol flashes.
- Press the Stop/C button once and the  symbol disappears.

## Altering a minute minder entry

- Press the Stop/C button.  
The minute minder time is interrupted.
- Set a new minute minder time, as described above.

## Minute minder + cooking function

The minute minder can be used at the same time as a cooking function, and counts down in the background.

- Press the  button whilst the cooking function is in progress.  
0:00 flashes in the display and the  symbol lights up.
- Use the time selector to set the minute minder time you require.
- After a few seconds the minute minder time set will begin to count down.  
A few seconds later, the display will change again to show the cooking duration counting down. The minute minder time is represented by the  symbol in the background.

The Start button is not used in this instance to start the minute minder, as pressing the Start button would also increase the cooking duration by a minute.

## To find out the minute minder time remaining

- Press the  button.  
The minute minder time still remaining will show in the display.

## Operation - Grilling

The grill can be used on 4 settings: by itself, and in combination with the Microwave function at one of three different power levels.

If the total grilling time required is less than 15 minutes, the grill should be pre-heated for approx. 5 minutes before placing food under it.

Thin, flat cuts of fish and meat should usually be turned half way through grilling for even results. Larger, chunkier pieces should be turned several times.

Grilling times depend on the type and thickness of the food and on the user's preference for a rare or well-cooked result.

When grilling directly on the rack, the glass tray should be placed underneath the rack to catch any fat or juices.

- Place the food in a suitable dish.
- Place the glass tray, the rack and glass tray, or the dish containing the food on the turntable.

Caution. The rack and glass tray become hot during use.  
Danger of burning.

The glass tray and grill rack will be easier to clean if washed in soapy water immediately after grilling.

### Grilling without the Microwave function

Ideal for grilling very thin cuts of meat.

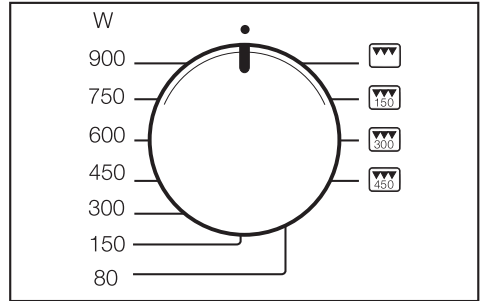

- Turn the power selector to . The grill symbol will light up in the display. 0:00 will flash.
- Select a cooking duration using the time selector.
- Press the Start button. An audible tone will sound at the end of the process.

### To change a cooking duration

The cooking duration can be changed during operation. To do this, interrupt the cooking programme by pressing the Stop/C button, and change the duration. Continue the cooking process by pressing the Start button.

The cooking duration can also be extended during operation by pressing the Start button once for each minute you wish to extend the cooking duration by.

The area on the ceiling around the grill becomes discoloured over time. This is an unavoidable consequence of use, and does not impair the function of the appliance in any way.

# Operation - Grilling

## Combination mode - Microwave + Grill

This function is very good for baking and browning. The microwave cooks the food, and the grill browns it.

The grill can be combined with one of three different microwave power levels: 150, 300 and 450 Watt.

It is possible during the cooking process to switch between the different power levels without interrupting the programme.

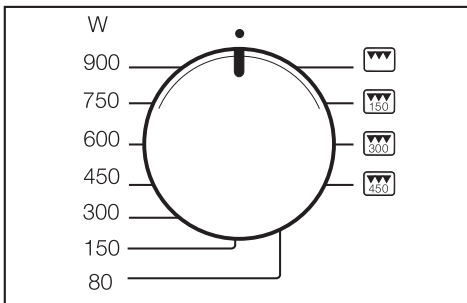

- Use the power selector to select the required combination or . the microwave power level and the grill symbol will light up in the display. 0:00 will flash.
- Select a cooking duration using the time selector.
- Press the Start button.  
An audible tone will sound at the end of the process.

## To change a cooking duration

The cooking duration entered can be changed during operation if required. Interrupt the process by pressing the Stop/C button, and change the duration. To continue, press the Start button.

The cooking duration can also be extended during operation by pressing the Start button once for each minute you wish to extend the cooking duration by.

## Use

The gourmet plate gets extremely hot when in use. Always use oven gloves when handling it to avoid burns. Place it on a suitable heat-resistant mat or pot rest.

## Before using for the first time

Before using the gourmet plate for the first time, fill it with 400 ml water and add 3-4 tbsps vinegar or lemon juice. Heat for 5 minutes on 450 W + Grill .

The gourmet plate has an easy-to-clean anti-stick coating so that food can be removed easily. The coating is susceptible to cuts and scratches. Therefore do not cut food up directly on the plate. Use wooden or plastic utensils to mix or turn food. Metallic or sharp objects can damage the coating.

## Searing/browning food

Because food does not stick to the anti-stick coating, only very little fat or oil is necessary when cooking with this dish.

Never leave the gourmet plate unattended when cooking with oil or fats, as these are a fire hazard if allowed to overheat.

- When using the gourmet plate, make sure that the food is ready to transfer to the hot gourmet plate as soon as it has heated up.

- Place the gourmet plate directly on the turntable.

Do not place it on the rack. Make sure there is a gap of approx. 2 cm between the gourmet plate and the interior walls of the appliance, otherwise sparking could occur and damage the gourmet plate and the oven interior.

- Heat the plate up on 450 W + Grill  for up to 5 minutes.

Do not overheat the empty gourmet plate, otherwise the coating could be damaged.

If using oil, you can either heat up the oil on the gourmet plate, or you can heat the oil separately and then add it to the plate.

Butter, however, should always be added after heating up the gourmet plate. It has a lower burning point than oil and would get too dark or burn if added too soon.

Always dry meat, poultry, fish and vegetables thoroughly before placing them on the gourmet plate.

Do not use the gourmet plate to cook eggs or reheat cooked eggs. The eggs can explode.

# Gourmet plate

---

## Some suggested uses

Pre-heat the gourmet plate directly on the turntable for up to 5 minutes at 450 W + Grill .

### **Fish fingers (frozen),**

150 g + 2 tbsp oil  
, 3-4 minutes each side

### **Hamburgers** 2 burgers + 2 tbsp oil

, 3-4 minutes each side

### **Croquette potatoes (frozen),**

10-12 + 2 tbsp oil  
, 6-8 minutes, turning halfway through

### **Fillet steak**, approx. 200 g

, 5 minutes each side (according to taste)

### **Pizza (frozen)**, 300 g,

, 7-9 minutes

### **Pizza (fresh)**, without pre-heating

, 15 minutes approx. (depending on topping)

## Recipes

### **Croque monsieur (Serves 3)**

6 slices of bread  
30 g soft butter  
75 g grated Emmental cheese  
3 slices of cooked ham

Butter the bread. Add the cheese to three of the bread slices in equal amounts and arrange a slice of ham on top of each. Place the remaining three slices of bread on top of the ham with the buttered side face down. Pre-heat the gourmet plate for 5 minutes at 450 W + Grill. Remove from the oven, then place the bread on the gourmet plate. Now place the gourmet plate on the turntable, and brown for approx 3 minutes per side at 450 W + Grill.

Other fillings could include drained tuna fish, finely sliced onion rings, pineapple, cheese and ham.



## Vegetable medley (Serves 3)

2 onions  
2 tbsp oil  
100 g mushrooms, cleaned  
150 g baby carrots or carrot slices  
100 g broccoli florets  
1 red pepper  
1 tomato  
Salt, pepper  
30 g grated Parmesan cheese

Slice the onions into fine rings. Halve, quarter and deseed the pepper, and then cut into strips. Dice the tomato. Place the gourmet plate on the turntable, and pre-heat for approx. 5 minutes at 450 W + Grill. Place the oil and the onions on the gourmet plate, and brown the onions for approx 2 minutes at 450 W + Grill. Add the mushrooms, carrots, broccoli, pepper strips, diced tomato and seasoning. Mix well. Cook for 6 minutes at 450 W + Grill. Turn out and sprinkle with Parmesan cheese before serving.

## Home-made potato rösti (Serves 2)

400 g peeled potatoes  
2 small onions  
50 g grated Emmental cheese  
Salt, pepper  
20 g butter

Coarsely grate the potato and onion, and mix together with the cheese, salt and pepper. Place the gourmet plate on the turntable, and pre-heat for approx. 5 minutes at 450 W + Grill. Melt the butter on the hot gourmet plate. Remove from the oven, add the potato mixture and press it into the gourmet plate. Place the gourmet plate back on the turntable, and cook for approx 8 minutes at 450 W + Grill. Turn over, and cook for a further 4 minutes until golden.

Garnish with smoked salmon or strips of ham.

# Gourmet plate

---

## Pork fillets (Serves 2)

1 piece pork fillet (approx. 400 g)  
4 rashers streaky bacon  
Salt, pepper  
10 g butter  
200 g sliced mushrooms  
200 ml double cream  
2 tbsp brandy

Cut the pork into 4 slices. Season each slice with salt and pepper, and wrap in a rasher of streaky bacon. Secure with a cocktail stick if necessary. Place the gourmet plate on the turntable, and pre-heat for approx. 5 minutes at 450 W + Grill. Remove from the oven. Add the butter to the plate, and place the pork slices on top. Now place the gourmet plate back on the turntable, and cook for approx 3 minutes per side at 450 W + Grill. Transfer the meat to a serving dish, cover and keep warm. Add the mushrooms, cream and brandy to the juices from the meat. Lightly cook for approx. 4 minutes at 900 W. Serve with the meat.

## Pork fillet in a Roquefort sauce

Cut a piece of pork into 4 slices. Cook for approx. 4 minutes in the pre-heated gourmet plate at 450 W + Grill. Add 50 ml white wine, 125 ml double cream, 2 tbsp roux (made from 1 tbsp each of flour and melted butter) and 150 g Roquefort cheese. Stir the sauce until smooth, and cook for a further 3 minutes.

## Curried chicken (Serves 3)

600 g chicken or turkey breasts  
2 tbsp oil  
2 tbsp white wine  
2 tbsp apple juice  
1 tbsp lemon juice  
Salt, freshly ground black pepper  
1 tsp curry powder  
A pinch of finely chopped rosemary  
A pinch of ground ginger  
A pinch of cayenne pepper  
1/2 tsp Tabasco sauce  
20 g butter

Dice the meat into 2 x 2 cm pieces. Combine the rest of the ingredients apart from the butter, mix together well, and sprinkle over the meat. Turn the meat so it is well coated with the herbs and spices, and leave to stand for approx. 30 minutes. Place the gourmet plate on the turntable, and pre-heat for approx. 5 minutes at 450 W + Grill. Remove from the oven, melt the butter in the heated plate, then add the meat. Place the plate back on the turntable, and cook for approx. 4 minutes at 450 W + Grill. Turn the meat, and cook for a further 4 minutes at the same setting. Drain surplus liquid from the meat if necessary so that it browns well.

### **Fisherman's salmon (Serves 2)**

2 pieces of salmon fillet (each 150 g)  
1 tbsp lemon juice  
Salt, white pepper

Drizzle the salmon with the lemon juice, and leave to stand for approx. 10 minutes. Place the gourmet plate on the turntable, and pre-heat for approx. 5 minutes at 450 W + Grill. Remove from the oven, pat the fish dry with kitchen paper, and place on the gourmet plate. Place the gourmet plate back on the turntable, and cook for approx 1 $\frac{1}{2}$  - 2 minutes per side at 450 W + Grill.

Serve with rice, hollandaise sauce or melted butter and a fresh green salad.

# Gourmet plate

---

## Pineapple cake

For the cake:

2 eggs

80 g sugar

1½ ripe bananas

30 g chocolate chips

100 g plain flour

¾ tsp. baking powder

Topping:

1 tin pineapple chunks  
(drained weight 240 g)

1½ tbsp brown sugar

1½ tbsp desiccated coconut

Beat together the eggs and sugar until frothy. Mash the bananas with a fork, and add to the egg mixture. Sift together the flour and the baking powder, stir in the chocolate chips, and fold into the mixture. Spread the mixture into the gourmet plate. Scatter the drained pineapple over the mixture, and sprinkle over the sugar and desiccated coconut. Place the gourmet plate on the turntable. Bake the cake for approx. 10 minutes at 450 W + Grill until golden. Cut into 8 slices.

## Quick almond tart

For the base:

100 g plain flour

½ level tsp baking powder

75 g butter or margarine

30 g sugar

Filling:

75 g butter

100 g chopped almonds

Few drops of almond essence

30 g sugar

½ packet vanilla sugar

75 ml double cream

To spread over the top:

50 g apricot jam

Mix together the flour, baking powder, butter and sugar, and knead to a smooth dough. Roll out the mixture into the gourmet plate, and build up the edges to 1 cm. Place the gourmet plate on the turntable, and bake the base for approx. 4 minutes at 450 W + Grill. For the filling, melt the butter in a pan on the hob, stir in the rest of the ingredients and simmer for approx. 5 minutes. Whilst still hot, spoon the mixture into the base. Place the gourmet plate on the turntable, and bake the tart for approx. 5 minutes at 450 W + Grill until golden. When cool, spread with apricot jam. Cut into 8 slices.

# Operation - Automatic programmes

All of the Automatic programmes are weight dependent.

The weight of the food can be displayed as metric (g) or imperial (lb). See "Changing the settings"

After selecting a programme, enter the weight of the food. The microwave oven automatically calculates the duration according to the weight entered.

After cooking, allow the food to stand at room temperature for the suggested number of minutes ("standing time") to allow the heat to be distributed evenly through the food.

## Automatic defrosting

There are five programmes for defrosting different types of food (\* button). The standing time for programme Ad 3 is up to 30 minutes, depending on the weight, and approx. 10 minutes for the remaining programmes.

Ad 1  Steak, cutlets (0.2 – 1.0 kg)

Ad 2  Mince (0.2 – 1.0 kg)

Ad 3  Chicken, small, whole (0.9 – 1.8 kg)

Ad 4  Cakes (0.1 – 1.4 kg)

Ad 5  Bread (0.1 – 1.0 kg)  
This programme is particularly suitable for defrosting sliced bread. If possible, place individual slices of bread in the microwave oven, or carefully separate them from one another at the halfway signal.

## Automatic cooking

There are four programmes for frozen food and eight programmes for fresh food. The standing time for each programme is approx. 2 minutes.

Only use the cover supplied with the microwave oven on Microwave Solo mode.

Never use a cover when the grill is switched on, i.e. on Programmes AC 4 to AC 8.

The plastic can melt and fuse with the food.

## Cooking food from frozen \*

AC 1  Vegetables (0.1 – 0.6 kg)

AC 2  Ready meals which can be stirred (0.3 – 1.0 kg)

AC 3  Bakes and gratins (0.2 – 0.6 kg)

AC 4  Chips (0.2 -0.4 kg)

## Cooking fresh food

AC 1  Vegetables (0.1 – 0.6 kg)

AC 2  Potatoes (0.1 – 0.8 kg)

AC 3  Fish (0.5 – 1.5 kg)

AC 4  Kebabs (0.2 – 0.8 kg)

AC 5  Chicken (small, whole) (0.9 -1.8 kg)

AC 6  Chicken drumsticks (0.25 – 1.0 kg)

AC 7  Fish pie (0.5 – 1.5 kg)



AC 8  Savoury bakes, e.g. Potato gratin (0.5 – 1.5 kg)

## Operation - Automatic programmes

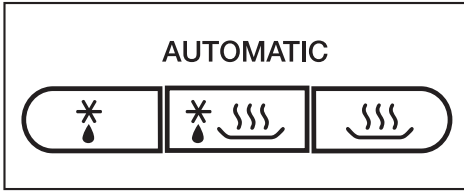

---



- Press the relevant button repeatedly until the Automatic programme required shows in the display. For example, to call up programme AC 5 (Chicken, small, whole), press the  button five times.

g or lb will flash in the display to request the weight to be entered, and the programme (e.g. AC 5) will light up, together with the symbols for the functions being used ( for Microwave and  for Grill).

- Use the rotary selector to enter the weight.
- Press the Start button.

The duration (which depends on the weight) will begin to count down, and the symbols for the functions that are currently in use will light up ( and/or ).

An audible tone will sound halfway through the cooking duration.

- Interrupt the programme to turn or stir the food, and then continue the programme.

The programmed duration can, if necessary, be extended by a few minutes during operation by pressing the Start button repeatedly until the duration required shows in the display. On all programmes it is only possible to extend the duration by a few minutes.

An audible tone will sound when the cooking programme is complete. The interior lighting will go out.

## Recipes for Automatic programmes

Below are some recipe suggestions for the Automatic programmes using the "Cooking fresh food" function . These can be adapted to suit your requirements.

It is important to follow the weight guidelines for the programme concerned. If the weight guidelines are exceeded, the food will not cook sufficiently.

### AC 1 Vegetables

Place the prepared vegetables in a container. Depending on the freshness and moisture content of the vegetables, add 3-4 tbsp water and a little salt or other seasoning. Enter the weight including that of the water, place the covered cooking container on the turntable and cook. Halfway through the cooking duration, an audible tone will sound to prompt you to turn or stir the food.

When cooking vegetables in a sauce, the weight entered must include the sauce. Do not exceed the maximum weight guidelines.

### Carrots in a chervil cream sauce (serves 2)

350 g carrots, washed and peeled  
5 g butter  
50 ml vegetable stock (instant)  
75 g crème fraîche  
1 tbsp white wine  
Salt and pepper  
A pinch of sugar  
½ tsp mustard  
1-2 tbsp fresh chervil, chopped, or  
1 tbsp dried chervil, chopped  
Approx. 1 tbsp cornflour

Cut the carrots into fine batons or slices (approx. 3-4 mm thick) and place in a cooking container.

Combine the rest of the ingredients to make a smooth sauce, and pour over the carrots.

Cover and cook. Stir when the audible tone sounds halfway through the cooking duration.

Setting: Cooking fresh food AC 1 

Weight: 525 g

Place cooking container on the turntable.

## Recipes for Automatic programmes

---

### AC 2 Potatoes

This programme can be used to cook new potatoes and boiled potatoes.

Enter the weight for the potatoes and the cooking liquid.

When cooking potatoes, add approx. 1 tbsp water per potato. If cooking the potatoes in their skins, pierce the skins several times with a fork or skewer before cooking, then cover the container and cook.

For new potatoes, wash and drain the potatoes and place them in a cooking container. Season with a little salt, cover and cook.

### Golden curried potatoes (serves 3)

500 g peeled potatoes  
1 onion, finely diced  
10 g butter  
1-2 tbsp curry powder  
250 ml vegetable stock (instant)  
50 ml double cream  
125 g peas (frozen)  
Salt and pepper

Cut the potatoes into large cubes (approx. 3 x 3 cm), or use small potatoes.

Place all of the ingredients into a suitable container and mix well.

Cover and cook. Stir when the audible tone sounds halfway through the cooking duration.

Setting: Cooking fresh food AC 2 

Weight: 1,000 g

Place cooking container on the turntable.

### AC 3 Fish

#### Fish curry (serves 4)

300 g pineapple pieces  
1 red pepper  
1 small banana  
500 g rosefish  
3 tbsp lemon juice  
30 g Butter  
100 ml white wine  
100 ml pineapple juice  
Salt, pepper and chilli pepper  
2 tbsp cornflour

Dice the fish and place in a suitable container. Drizzle with lemon juice.

Quarter the peppers, remove the seeds and pith, and cut into narrow strips.

Peel and slice the banana. Add to the fish along with the pepper and pineapple pieces, and mix well. Add the butter.

Mix together the wine, juice, seasoning and cornflour to make a smooth sauce, and pour over the fish. Mix everything thoroughly, then cover and cook.

Setting: Cooking fresh food AC 3 

Weight: approx. 1,200 g

Place cooking container on the turntable.



## AC 4 Kebabs

### Pork kebabs (makes 8 kebabs)

1 piece of pork fillet, approx. 300 g  
1 red pepper  
2 onions

For the marinade:  
8 tbsp vegetable oil  
Salt, pepper, paprika and chilli powder

8 wooden kebab skewers

Cut the pork fillet into 16 cubes. Wash the pepper and cut into bite-sized pieces. Peel the onion and cut into eighths.

Arrange the meat, peppers and onions alternately on the skewers.

Mix together the ingredients for the marinade well, and brush onto the kebabs. Set aside for 1 hour.

Put the kebabs on the grilling rack, and place on the glass tray in the microwave oven. Turn halfway through grilling when the audible tone sounds.

Setting: Cooking fresh food AC 4 

Weight: 100 g per kebab

Place the grilling rack containing the food on the glass tray on the turntable

### Chicken kebabs (makes 8 kebabs)

4 chicken breasts, each approx. 120 g  
4 pineapple slices (tinned)  
16 apricot halves (tinned)

For the marinade:  
4 tbsp vegetable oil  
4 tbsp sesame oil  
Salt and pepper  
½ tsp paprika  
½ tsp curry powder  
A little chilli powder

Optional: ground ginger or ground coriander

8 wooden kebab skewers

Cut each chicken breast into 4 pieces. Cut the pineapple slices into quarters.

Drain the apricots well.

Mix together all of the ingredients for the marinade.

Arrange the chicken pieces, pineapple and apricots alternately on the wooden skewers, brush with the marinade and set aside for 1 hour.

Put the kebabs on the grilling rack, and place on the glass tray in the microwave oven. Turn halfway through grilling when the audible tone sounds.

Setting: Cooking fresh food AC 4 

Weight: 100 g per kebab

Place the grilling rack containing the food on the glass tray on the turntable

## Recipes for Automatic programmes

---

### AC 5 Chicken

Cut the chicken in half. Brush with melted butter or oil, and season.

Arrange the two halves with the cut side uppermost on the grilling rack on top of the glass tray, and place in the microwave oven. Halfway through cooking when an audible tone sounds, turn the chicken over and continue to cook.

### AC 6 Chicken drumsticks

Brush the drumsticks with melted butter or oil, and season. Put the drumsticks on the grilling rack on top of the glass tray, and place in the microwave oven. Halfway through the cooking duration when the audible tone sounds, turn the drumsticks and continue to cook.

### For programmes AC 5 and AC 6

For a good colour and flavour when grilling chicken, sprinkle with a mixture of paprika and curry powder.

### AC 7 Fish pie

#### Crispy fish pie (Serves 2)

400 g rosefish fillets  
3 tbsp lemon juice  
Salt and white pepper  
50 g butter  
2 tsp mustard  
1 onion, finely diced  
40 g Cheddar, grated  
20 g golden breadcrumbs  
2 tbsp freshly chopped dill

Drizzle the fish with the lemon juice, and leave to stand for approx. 10 minutes. Grease a shallow baking dish with a little butter.

Pat the fish dry, season with salt and pepper and arrange in the dish. Melt the butter for 40-50 seconds at 450 W, then mix well with the mustard, onion, Cheddar, breadcrumbs and dill. Spread over the fish. Cook till golden.

Setting: Cooking fresh food

AC 7 

Weight: approx. 600 g

Place cooking container on the turntable.

## Rosefish and tomato gratin (serves 4)

500 g rosefish fillet  
2 tbsp lemon juice  
500 g tomatoes  
Herb salt  
2 tsp oregano, finely chopped  
150 g Cheddar cheese, grated

Cut the rosefish into pieces, drizzle with lemon juice and leave to stand for approx. 10 minutes.

Dice the tomatoes, and place in a baking dish with the fish and half of the cheese.

Season generously with herb salt and oregano, and mix well.

Sprinkle with the rest of the cheese and bake uncovered.

Setting: Cooking fresh food

AC 7 

Weight: approx. 1,150 g

Place cooking container on the turntable.

## AC 8 Savoury bakes

### Vegetable gratin (serves 4)

400 g cauliflower or broccoli  
400 g carrots

For the cheese sauce:

20 g margarine  
20 g plain flour  
300 ml vegetable stock (instant)  
200 ml milk  
100 g Emmental cheese, diced  
50 g Cheddar cheese, grated  
Salt, pepper and grated nutmeg  
1 tbsp chopped parsley

Cut the cauliflower or broccoli into small rosettes, and finely slice the carrots (approx. 3 mm thick). Place the vegetables in a baking dish (approx. 24 cm in diameter), and mix well.

Melt the margarine in a pan on the hob, stir in the flour and then add the stock and milk whilst continuing to stir. Stir in the Emmental cheese, and simmer until the cheese has melted. Season generously with salt, pepper and grated nutmeg, and stir in the parsley. Pour the sauce over the vegetables, sprinkle with Cheddar and bake uncovered.

Setting: Cooking fresh food AC 8 

Weight: 1,500 g

Place cooking container on the turntable.

## Recipes for Automatic programmes

---

### **Potato cheese gratin (serves 4)**

500 g potatoes, peeled  
250 ml double cream  
125 g crème fraîche  
150 g Cheddar, grated  
1 clove of garlic  
Salt, black pepper, nutmeg  
Butter

Slice the potatoes finely, mix with approx. 2/3 of the cheese, and place in the base of a greased baking dish (approx. 24 cm in diameter) with the garlic.

Mix together the cream and crème fraîche, season with salt, pepper and nutmeg and pour over the potato and cheese mixture. Sprinkle with the rest of the cheese and bake uncovered.

Setting: Cooking fresh food AC 8 

Weight: 1,050 g

Place cooking container on the turntable.

# Saving your favourite programme (Memory)

One favourite programme can be saved in memory. This programme can be used for your most frequently cooked recipe. The programme can have up to 3 stages (e.g.: 1 minute at 600 W, followed by 2 minutes on Grill, and finally 3 minutes at 150 W + Grill).

## Programming

(The example given is for a 3-stage programme.)

- First select the function for the first stage.
- Then select the duration.

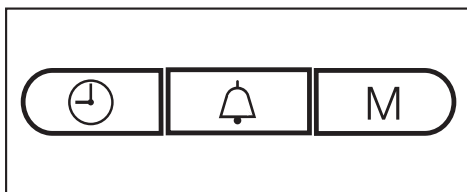

- Press the M button. 1 will light up in the display, and 2 will flash.
- Then select the second function and duration.
- Press the M button again. 2 will light up in the display, and 3 will flash.
- Now select the third function and duration, and then press the M button.

After this third step, you can use the M button to scroll through your entry and check it.

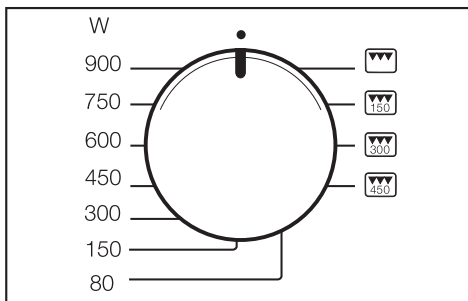

- When you have finished programming, turn the power selector to the 12 o'clock position.
- Start the programme to save the entry. Only ever run the entire programme with food in the appliance.

If there is no food in the appliance, press the Stop/C button twice as soon as you have started the programme so that the appliance is not damaged by having no food in it.

1- and 2-stage programmes can be saved in the same way: the programming process is finished when the programme selector is in the 12 o'clock position and the Start button has been pressed, while pressing the M button shows the next stage.

## Changing an entry

- Entering a new programme overrides the previously saved programme.

# Saving your favourite programme (Memory)

---

## To call up your favourite programme

- Turn the programme selector to the 12 o'clock position.
- Press the M button.
- Press the Start button.

In the event of a power cut, the favourite programme is no longer saved and must be re-entered.

## Changing the settings

Some of the standard settings for the appliance (which are set at the factory) have an alternative which you can select if required.

Please consult the chart for the different options. The factory settings are marked with a star\* on the chart.

Proceed as follows:

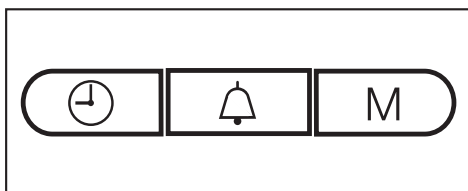

- Press and hold the ⌚ and M buttons at the same time until **P 1** and  light up in the display. Then release them. If you press them for too long, the time of day will appear again in the display.
- Use the time selector to select the setting that you wish to change (**P 1** to **P 5** and **P 0**). Turn it until the setting required shows in the display.
- Then press the M button to call up the setting. **5** will appear in the display to show that the setting can be changed.
- Turn the time selector if you wish to change the setting (see chart), and confirm your entry by pressing the M button (for **P 5** and **P 0**, press and hold the M button for approx. 4 seconds).

The change is then stored in memory. **P** will appear in the display again, together with the number for the setting.

The other settings can be changed in the same way.

- When you have finished making the changes you require, press the Stop/C button.

The altered settings are retained after a power cut.

## Changing the settings

Setting		Settings available (* factory default)	
<i>P 1</i>	Night time switch-off	<i>5 0</i> *	Night time switch-off is deactivated.
		<i>5 1</i>	Night time switch-off is activated. The time of day display is switched off from 11 pm to 4 am.
<i>P 2</i>	Automatic keep-warm function	<i>5 1</i> *	The automatic keep-warm function is activated.
		<i>5 0</i>	The automatic keep-warm function is deactivated.
<i>P 3</i>	"door" message	<i>5 1</i> *	The "door" message appears if the door has not been opened for 20 minutes. Start is then blocked, as it is assumed that there is no food in the microwave oven.
		<i>5 0</i>	The "door" message does not appear.
<i>P 4</i>	Audible tone	<i>5 1</i> *	The audible tone sounds briefly as a reminder every 5 minutes for 20 minutes after the end of the programme.
		<i>5 0</i>	The audible tone is deactivated.
<i>P 5</i>	Demo mode (for dealer showroom use only)	<i>5 0</i> *	Demo mode is deactivated. When demo mode is deactivated, _ _ _ _ appears briefly in the display.
		<i>5 1</i>	The appliance is set to demo mode. When a button or selector is operated, <i>NE5_</i> shows briefly in the display. The appliance can be operated, but the microwave and grill functions do not come on.
<i>P 6</i>	Unit of weight	<i>5 0</i> *	The weight of the food is displayed as metric (g).
		<i>5 1</i>	The weight of the food is displayed as imperial (lb).
<i>P 0</i>	Factory default	<i>5 1</i> *	Factory default settings have been restored, or have not been changed.
		<i>5 0</i>	Factory default settings have been changed.



Select the following microwave power levels to reheat food:

Drinks . . . . .	900 W
Food . . . . .	600 W
Food for babies and toddlers . . .	450 W

We do not recommend heating or reheating food or drinks for babies or young children in the microwave oven. Any decision to do this is the responsibility of the user, and should only be done with the utmost care. Pasteurised or sterilised cooked food should be gently heated at 450 W, and tasted to make sure it is not too hot for a baby's palate before serving. When reheating other food or drink, heat to a high temperature and allow to cool to a suitable heat for eating. For formula milk follow the manufacturer's instructions.

## Tips on reheating

Always use a lid or cover for reheating food, except when a drier finish is needed, e.g. breaded poultry/meat.

Always remove the lids from jars, especially jars of baby food. Loosen the screw cap and the rubber teat before warming baby bottles. When reheating liquids, place the boiling rod supplied with the appliance into the cup or glass. Never reheat hard boiled eggs in a microwave oven, even without the shell. The eggs can burst.

Food taken straight from the refrigerator will take longer to reheat than food stored at room temperature. The time required depends on the nature of the food, its initial temperature and the amount to be cooked.

Always ensure that food is sufficiently cooked or reheated.

If in any doubt that a sufficiently high temperature has been reached, continue reheating for a little longer.

Stir or turn food from time to time during cooking. Stir the food from the outside towards the middle, as food heats more quickly from the outside.

## After reheating

Be careful when removing a dish from the oven. It may be hot.

Although heat is not normally produced in the container itself by the microwaves (apart from stoneware), heat transfer from the food to the container may be considerable, making the container itself hot.

Allow food to stand for a few minutes at room temperature at the end of a reheating process to enable the heat to spread evenly throughout the food.

After heating food, especially food for babies and small children, stir the food or shake the container and check that the temperature does not pose any danger. Double check after it has been left to stand.

# Cooking

---

Place the food in a microwave-proof dish and cover it.

When cooking, it is a good idea to select a power level of 900 W to start with and then when the food is hot reduce the power level to 450 W for more gentle continued cooking.

For dishes such as **rice or semolina pudding**, first select a power level of 900 W, and then reduce it to 150 W for simmering.

## Tips on cooking

Vegetable cooking durations depend on the texture of the vegetable.

Fresh vegetables contain more water than vegetables which have been stored, and usually cook more quickly. Add a little water to vegetables which have been stored.

Food taken straight from the refrigerator takes longer to cook than food which has been kept at room temperature.

Stir or turn food from time to time during cooking to help it cook more evenly.

Ensure that food such as meat and fish are thoroughly cooked for an appropriate length of time.

Foods with a thick skin or peel, such as tomatoes, sausages, jacket potatoes and aubergines, should be pierced or the skin cut in several places before cooking to allow steam to escape and to prevent the food from bursting.

Eggs can only be cooked in their shells in the microwave oven in a specially designed egg-boiling device available from specialist shops.

Eggs can burst, even after they have been taken out of the oven.

Eggs can be cooked without their shells in the microwave oven, only if the yolk membrane has been punctured several times first.

The pressure could otherwise cause the egg yolk to explode.

## After cooking

Be careful when removing a dish from the oven. It may be hot.

Although heat is not normally produced in the container itself by the microwaves (apart from stoneware), heat transfer from the food to the container may be considerable, making the container itself hot.

Allow food to stand for a few minutes at room temperature at the end of cooking to enable the heat to spread evenly throughout the food.

# Defrosting/Defrosting and reheating or cooking

Do not re-freeze partially or fully defrosted food. Consume defrosted food as soon as possible, as it will lose its nutritional value and spoil if left for too long. Defrosted food may only be re-frozen after it has been cooked.

## Defrosting

Select the following microwave power settings to defrost food:

- 80 W  
for defrosting very delicate food, e.g. cream, butter, gateau and cheese.
- 150 W  
for defrosting everything else.

Remove the food from its packaging and place in a microwave-proof container. Do not cover. Turn, stir or separate the food about halfway through the defrosting time.

To defrost meat, unpack the frozen meat and place it on an upturned plate in a glass or china container so that the meat juice can run off and be collected. Turn halfway through defrosting.

It is particularly important to observe food hygiene rules when defrosting poultry. Do not use the liquid from the defrosted poultry. Pour it away, and wash the tray, the sink and your hands. Danger of salmonella poisoning.

Fish does not need to be fully defrosted before cooking.

Defrost so that the surface is sufficiently soft to take herbs and seasoning.

## Defrosting followed by reheating or cooking

Deep-frozen food can be defrosted and immediately reheated or cooked.

After defrosting, select 900 W followed by 450 W.

Remove the food from its packaging and place in a covered microwave-proof dish for defrosting and reheating or cooking. Exception: minced meat should be left uncovered while cooking.

Soups, stew and vegetables should be stirred several times during the process. Carefully separate and turn slices of meat halfway through the programme. Turn pieces of fish at the halfway stage.

## After defrosting followed by reheating or cooking

Allow the food to stand at room temperature for a few minutes to enable the heat to spread evenly throughout the food.

## Some suggested uses

Food	Quantity	Micro-wave power level (in watts)	Time (in minutes)	Notes
Melting butter and margarine	100 g	450	1:00 – 1:10	Do not cover.
Melting chocolate	100 g	450	3:00 – 3:30	Do not cover. Stir halfway through melting.
Dissolving gelatine	1 packet + 5 tbsp water	450	0:10 – 0:30	Do not cover. Stir halfway through dissolving.
Preparing flan topping/jelly glaze	1 packet + 250 ml liquid	450	4 – 5	Do not cover. Stir halfway through heating.
Yeast dough	Made with 100 g flour	80	3 – 5	Cover and leave to prove.
Popcorn	1 tbsp (20 g) popcorn	900	3 – 4	Place popcorn in a 1-litre container, cover and cook.
Salad dressings	125 ml	150	1 – 2	Heat uncovered on a gentle heat.
Tempering citrus fruits	150 g	150	1 – 2	Place on a plate, do not cover.
Bacon	100 g	900	2 – 3	Place on kitchen paper, do not cover.
Softening ice cream	500 g	150	2	Place open ice cream container in microwave oven.
Skinning tomatoes	3 tomatoes	450	6 – 7	Cut a cross shape into the top of each tomato, cover, and heat in a little water. The skins will slip off easily. Take care, as the tomatoes may get very hot.
Strawberry jam	300 g strawberries, 300 g jam sugar	900	7 – 9	Mix the fruit and sugar in a deep container, cover and cook.
Defrosting and baking bread rolls	2 rolls	150 + Grill Grill	1 – 2 4 – 6	Place uncovered on the rack, turning halfway through.

**The information given in this chart is intended only as a guide.**

Miele branded cleaning and conditioning products are available from the Miele Spare Parts Department or via the internet at [www.miele-shop.com](http://www.miele-shop.com).

Disconnect the microwave oven from the power supply before cleaning (e.g. switch off at the socket and remove the plug).

Do not use a steam-cleaning appliance to clean this microwave oven. Steam could reach the electrical components and cause a short circuit.

## Oven housing, interior and inside of the door

The oven interior can get hot during use. Danger of burning. Clean the oven interior as soon as it has cooled down. Waiting too long can make cleaning unnecessarily difficult and in some cases impossible. In certain circumstances, very heavy soiling can even damage the appliance.

The housing, interior and inside of the door can be cleaned using a damp cloth with a little washing up liquid or a mild detergent and water. Wipe dry with a soft cloth.

For more heavy soiling, heat a glass of water for 2 to 3 minutes until the water begins to boil. The steam will collect on the walls and soften the soiling.

The oven interior can now be wiped clean using a little washing-up liquid if necessary.

To help prevent re-soiling, external stainless steel surfaces can be treated with a conditioning agent for stainless steel (available from Miele).

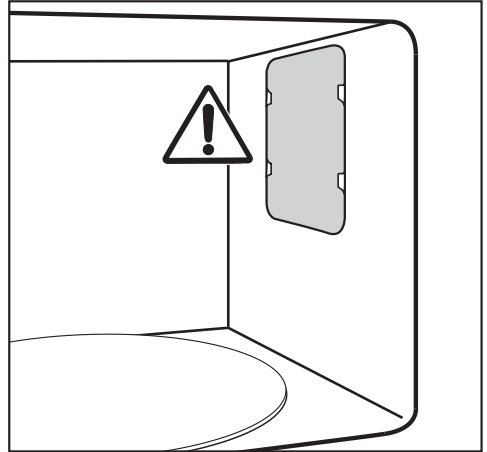

Do not remove the cover to the microwave outlet inside the oven, nor the film covering the inside of the door.

Do not let water or any small particles penetrate the vents in the appliance.

Wring out cloths before using them to wipe out the oven to avoid moisture getting into the openings.

Do not use abrasive cleaners, as these scratch the surface.

## Cleaning and care

To neutralise odours in the oven, put a cup of water with some lemon juice in the oven and simmer for a few minutes.

The door should be kept clean at all times and checked at regular intervals for any signs of damage.

If any damage is noticed, the appliance should not be used until the fault has been rectified by a Miele authorised and trained service technician.

To clean the interior:

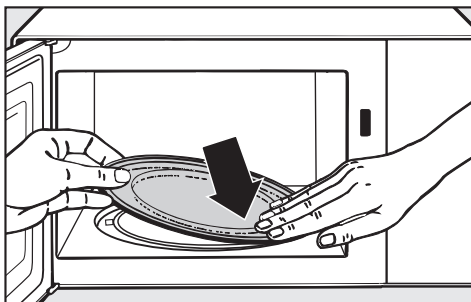

- Remove the turntable, and wash in the dishwasher or by hand.

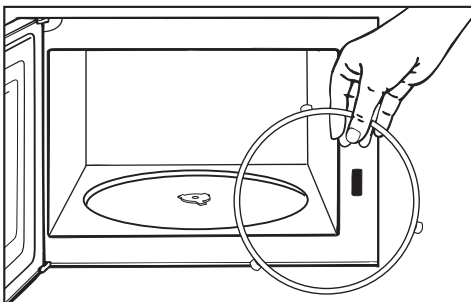

- Always keep the roller ring underneath it clean as well as the oven floor to enable the turntable to turn smoothly.

- Clean the contact area between the turntable and the carrier.

Do not turn the carrier manually, as this could damage the drive motor.

## Appliance front

Remove any soiling immediately. If this is not done, it might become impossible to remove and could cause the surface to alter or discolour.

Clean the front using a damp Miele microfibre E-cloth or with a clean sponge and a solution of hot water and washing-up liquid. Then dry with a soft cloth.

All external surfaces are susceptible to scratching. Scratches on glass surfaces could even cause a breakage.

Contact with unsuitable cleaning agents can alter or discolour the external surfaces.

## To avoid damaging the surface of your appliance, do not use:

- cleaning agents containing soda, ammonia, acids or chlorides,
- cleaning agents containing descaling agents,
- abrasive cleaning agents, e.g. powder cleaners and cream cleaners.
- solvent-based cleaning agents,
- stainless steel cleaning agents,
- dishwasher cleaner,
- oven sprays,
- glass cleaning agents,
- hard, abrasive sponges and brushes, e.g. pot scourers,
- eraser blocks,
- sharp metal scrapers.

To help prevent re-soiling, a proprietary conditioning agent for stainless steel can also be used which is available from Miele. Follow the instructions on the packaging. Wipe dry with a soft cloth.

## Accessories supplied

### Boiling rod

The boiling rod can be washed in a dishwasher.

### Cover

Wash and dry the cover after each use. The cover can be washed in a dishwasher. However, discolouration caused by natural dyes, e.g. from

carrots, tomatoes or ketchup, may occur.

This discolouration is irreversible but does not affect the stability of the cover.

### Rack

Wash and dry the rack after each use.

It is dishwasher-proof, or can be washed by hand in hot water with a little washing up liquid.

Remove stubborn soils with a stainless steel cleaner.

### Glass tray

The glass tray can be washed by hand using a solution of hot water and washing up liquid, or it can be washed in a dishwasher.

Do not use abrasive cleaning agents.

### Gourmet plate

Clean the gourmet plate with hot water and a cloth with a little washing up liquid to remove any grease.

Do not use wire wool, or abrasive sponges, aggressive or abrasive cleaning agents.

The gourmet plate is not suitable for cleaning in a dishwasher.

If the gourmet plate has been used to prepare foods with a strong aroma, you can neutralise any odours by adding some water and lemon juice to the gourmet plate and heating in the microwave at maximum power for a few minutes. Rinse the gourmet plate afterwards with clean water.

# Problem solving guide

---

Repairs to this appliance must only be carried out by a Miele approved service technician in strict accordance with current local and national safety regulations. Repairs and other work by unqualified persons could be dangerous. The manufacturer cannot be held liable for unauthorised work.

However, some minor problems can be corrected without contacting Miele.

## What to do if . . .

### . . . a programme will not start.

Check whether,

- the appliance door is closed properly.
- the system lock has been activated (see "System lock").
- the word "door" has appeared in the display. The door has remained closed for 20 minutes or longer (see "door" message").
- the appliance is plugged into the mains supply and switched on at the socket.
- the mains fuse has tripped. If it has, there could be a fault with the appliance, the household electricity supply or another appliance (disconnect the appliance from the electricity supply and contact a qualified electrician or the Miele Service Department. See "After sales service").

### . . . a noise can be heard after a cooking programme.

This is not a fault.

The cooling fan will continue to run for a while after the oven has been switched off to dispel any moisture from the oven and prevent it settling on the control panel or surrounding furniture. It will switch off automatically.

### . . . the display does not light up.

Check whether,

- the time of day display has been switched off (press and hold the ⊕ button for a few seconds).
- the time of day display has been programmed to switch off at night.

### . . . the turntable does not turn smoothly.

- Check whether the area underneath the turntable is clean.
- Check whether the contact area between the turntable and the carrier are clean.

Remove any soiling.

### . . . food is not adequately defrosted, heated or cooked at the end of the selected cooking duration.

- Check whether the correct power level was selected for the duration set.  
The lower the power level, the longer the duration required.
- Check whether the programme has been interrupted and not restarted.



### **. . . the microwave function is working but not the oven lighting.**

- You can use the appliance as you usually do, but the lamp has broken. To change the lamp, please contact the Miele Service Department.

### **. . . strange noises are heard when the microwave oven is being used.**

Check whether,

- the food is covered with aluminium foil.  
If so, remove it.
- sparks are being created by the use of crockery with a metallic finish. See notes on suitable types of containers.

### **. . . the time of day in the display is not accurate.**

If there has been a power cut, the time automatically switches back to 12:00. The time of day needs to be re-set.

- Set the correct time of day.

### **. . . food cools down too quickly.**

In the microwave oven, food begins to cook from the outside first, the inside of the food relying on the slower conduction of heat.

If food is cooked at a high power level, it is possible that the heat may not have reached the centre of the food, so it is hot on the outside but cold in the centre. During standing time, heat is transferred to the centre of the food. This may leave the food warm in the middle but cool on the outside. When reheating food with different densities,

such as plated meals, it is therefore sensible to select a lower power level and lengthen the duration required.

### **. . . the microwave oven switches itself off during a cooking, reheating or defrosting programme.**

There may be insufficient air circulation.

Check whether,

- the air inlet or outlet is blocked.

Remove any objects if necessary. The appliance switches off automatically in cases of overheating. Cooking can be continued after a cooling-down period.

If the microwave oven switches itself off repeatedly, please call the Miele Service Department.

If it is not possible to remedy a fault by following the instructions given above, on no account open the appliance casing.

This microwave oven should only be repaired by a suitably qualified Miele approved service technician..

## After sales service

---

In the event of any faults which you cannot remedy yourself, or if the appliance is under guarantee, please contact:

– your Miele Dealer

or

– the Miele Service Department (see back cover for contact details).

Please note that telephone calls may be monitored and recorded to improve our service.

When contacting your Dealer or the Miele Service Department, please quote the model and serial number of your appliance. These are to be found on the data plate inside the front of the appliance.

N.B. A call-out charge will be applied for service visits where the problem could have been resolved as described in these instructions.

## Guarantee

For information on the appliance guarantee specific to your country, please contact Miele. See back cover for contact details.

In the UK, your appliance is guaranteed for 2 years from the date of purchase. However, you must activate your cover by calling 0845 365 6640 or registering online at [www.miele.co.uk](http://www.miele.co.uk).

Before connecting the appliance, ensure that it has not been damaged in any way. Do not use a damaged appliance.

### Electrical connection U.K.

All electrical work should be carried out by a suitably qualified and competent person in strict accordance with current national and local safety regulations (BS 7671 in the UK).

The appliance is supplied with a mains cable and moulded plug ready for connection to an a.c. single phase 220-240 V 50 Hz supply.

The voltage and connected load are given on the data plate which is located inside the door to the appliance. Please ensure that these match the household mains supply. The fuse rating is quoted on the plug.

Connection should be made via a fused connection unit or a fused plug and a suitable switched socket, or via a suitable isolator, which complies with national and local safety regulations, and the on/off switch should be easily accessible after the appliance has been installed. If it is installed via an isolator switch, connection **must** be carried out by an electrician.

When switched off there must be an all-pole gap of 3 mm in the isolator switch (including switch, fuses and relays acc. to EN 60335).

If the switch is not accessible after installation (depending on country) an additional means of disconnection must be provided for all poles.

For extra safety it is advisable to protect the appliance with a residual current device. Please contact a qualified electrician for advice.

**WARNING**  
**THIS APPLIANCE MUST BE**  
**EARTHED**

### Non-rewireable plugs BS 1363

The fuse cover must be re-fitted when changing the fuse, and if the fuse cover is lost the plug must not be used until a suitable replacement is obtained. The colour of the correct replacement cover is that of the coloured insert in the base of the plug, or the colour that is embossed in words on the base of the plug, (as applicable to the design of plug fitted).

Replacement fuses should be ASTA approved to BS 1362 and have the correct rating. Replacement fuses and fuse covers can be purchased from your local electrical supplier.

If the connection cable is damaged it must be replaced by a Miele approved Service Technician only.

This appliance conforms with European Standard EN 55011 as a Group 2, Class B product. Group 2 appliances use high frequency energy in the form of electro-magnetic waves to create heat in food. Class B is assigned to appliances that are suitable for domestic use.

## Electrical connection

---

This appliance must not be connected to the inverter of an autonomous power supply, e.g. a solar power system. When switching the appliance on, a surge in power could trigger the safety cut-out mechanism. This could damage the electronic unit.

The appliance must not be used with so-called energy saving devices. These reduce the energy supply to the appliance which could then become too warm. Using such devices could alter the specification of the product.

When installing the appliance ensure that there is sufficient ventilation to and from the appliance both underneath and to the rear. Do not block the ventilation gaps or block the gap between the base of the appliance and the worktop surface.

A minimum installation height of 85 cm must be maintained.

The microwave oven can be placed on a worktop.

To ensure adequate ventilation, a minimum gap of 5 cm is required between the appliance and any neighbouring furniture or walls. There must be a minimum gap of 19.5 cm between the top of the appliance and anything above it.

The microwave oven can also be built into a tall unit using a microwave lift up door. A special fitting kit available from your Miele Dealer or the Miele Spare Parts Department is required. It is supplied with fitting instructions.

Do not lower the lift up door when the microwave oven is in operation.





## United Kingdom

Miele Co. Ltd.  
Fairacres, Marcham Road  
Abingdon, Oxon, OX14 1TW  
Tel: 0845 365 0555, Fax: 0845 365 0777  
Customer Contact Centre Tel: 0845 365 6600  
E-mail: [info@miele.co.uk](mailto:info@miele.co.uk)  
Internet: [www.miele.co.uk](http://www.miele.co.uk)

## Australia

Miele Australia Pty. Ltd.  
ABN 96 005 635 398  
1 Gilbert Park Drive, Knoxfield, VIC 3180  
Tel: 1300 464 353, Fax: (03) 9764 7149  
Internet: [www.miele.com.au](http://www.miele.com.au)

## China

Miele (Shanghai) Trading Ltd.  
1-3 Floor, No. 82 Shi Men Yi Road  
Jing' an District  
200040 Shanghai, PRC  
Tel: +86 21 6157 3500, Fax: +86 21 6157 3511  
E-mail: [mieleshanghai@cn.miele.com](mailto:mieleshanghai@cn.miele.com)  
Internet: [www.miele.cn](http://www.miele.cn)

## Miele (Hong Kong) Limited

41/F - 4101, Manhattan Place  
23 Wang Tai Road  
Kowloon Bay  
Hong Kong  
Tel: (852) 2610 1331, Fax: (852) 2610 1013  
Email: [mielehk@miele.com.hk](mailto:mielehk@miele.com.hk)

## India

Miele India Pvt. Ltd.  
Ground Floor, Copia Corporate Suites  
Plot No. 9, Jasola  
New Delhi - 110025  
Tel: 011-46 900 000, Fax: 011-46 900 001  
E-mail: [customercare@miele.in](mailto:customercare@miele.in), Internet: [www.miele.in](http://www.miele.in)

## Ireland

Miele Ireland Ltd.  
2024 Bianconi Avenue  
Citywest Business Campus, Dublin 24  
Tel: (01) 461 07 10, Fax: (01) 461 07 97  
E-Mail: [info@miele.ie](mailto:info@miele.ie), Internet: [www.miele.ie](http://www.miele.ie)

## Manufacturer: Miele & Cie. KG

Carl-Miele-Straße 29, 33332 Gütersloh, Germany

# Miele

## Malaysia

Miele Sdn Bhd  
Suite 12-2, Level 12  
Menara SapuraKencana Petroleum  
Solaris Dutamas No. 1, Jalan Dutamas 1  
50480 Kuala Lumpur, Malaysia  
Phone: +603-6209-0288  
Fax: +603-6205-3768

## New Zealand

Miele New Zealand Limited  
Unit L, 10-20 Sylvia Park Road  
Mt. Wellington, 1060, Auckland, NZ  
Tel: 0800 264 353, Fax: 0800 463 453  
Internet: [www.miele.co.nz](http://www.miele.co.nz)

## Singapore

Miele Southeast Asia  
Miele Pte. Ltd.  
163 Penang Road  
# 04 - 02/03 Winsland House II  
Singapore 238463  
Tel: +65 6735 1191, Fax: +65 6735 1161  
E-Mail: [infosea@miele.com.sg](mailto:infosea@miele.com.sg)  
Internet: [www.miele.sg](http://www.miele.sg)

## South Africa

Miele (Pty) Ltd  
63 Peter Place, Bryanston 2194  
P.O. Box 69434, Bryanston 2021  
Tel: (011) 875 9000, Fax: (011) 875 9035  
E-mail: [info@miele.co.za](mailto:info@miele.co.za)  
Internet: [www.miele.co.za](http://www.miele.co.za)

## United Arab Emirates

Miele Appliances Ltd.  
P.O. Box 11 47 82  
Gold & Diamond Park  
Sheikh Zayed Road  
Building 6 / Offices Nos. 6-214 to 6-220  
Dubai  
Tel: +971-4-341 84 44  
Fax: +971-4-341 88 52  
E-Mail: [info@miele.ae](mailto:info@miele.ae), Internet: [www.miele.ae](http://www.miele.ae)