

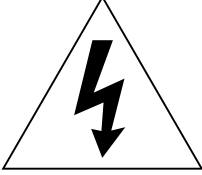



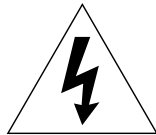
marantz®

Model SR4000 User Guide

AV Surround Receiver



	CAUTION RISK OF ELECTRIC SHOCK DO NOT OPEN	
<p>CAUTION: TO REDUCE THE RISK OF ELECTRIC SHOCK,</p> <p>DO NOT REMOVE COVER (OR BACK)</p> <p>NO USER-SERVICEABLE PARTS INSIDE</p> <p>REFER SERVICING TO QUALIFIED SERVICE PERSONNEL</p>		



The lightning flash with arrowhead symbol, within an equilateral triangle, is intended to alert the user to the presence of uninsulated "dangerous voltage" within the product's enclosure that may be of sufficient magnitude to constitute a risk of electric shock to persons.



The exclamation point within an equilateral triangle is intended to alert the user to the presence of important operating and maintenance (servicing) instructions in the literature accompanying the appliance.

WARNING

**TO REDUCE THE RISK OF FIRE OR ELECTRIC SHOCK,
DO NOT EXPOSE THIS APPLIANCE TO RAIN OR MOISTURE.**

CAUTION: TO PREVENT ELECTRIC SHOCK, MATCH WIDE BLADE OF PLUG TO WIDE SLOT, FULLY INSERT.

ATTENTION: POUR ÉVITER LES CHOCS ÉLECTRIQUES, INTRODUIRE LA LAME LA PLUS LARGE DE LA FICHE DANS LA BORNE CORRESPONDANTE DE LA PRISE ET POUSSER JUSQU'AU FOND.

NOTE TO CATV SYSTEM INSTALLER:

This reminder is provided to call the CATV (Cable-TV) system installer's attention to Article 820-40 of the NEC, that provides guidelines for proper grounding and, in particular, specified that the cable ground shall be connected to the grounding system of the building, as close to the point of cable entry as practical.

NOTE:

This equipment has been tested and found to comply with the limits for a Class B digital device, pursuant to Part 15 of the FCC Rules. These limits are designed to provide reasonable protection against harmful interference in a residential installation. This equipment generates, uses and can radiate radio frequency energy and, if not installed and used in accordance with the instructions, may cause harmful interference to radio communications. However, there is no guarantee that interference will not occur in a particular installation. If this equipment does cause harmful interference to radio or television reception, which can be determined by tuning the equipment off and on, the user is encouraged to try to

correct the interference by one or more of the following measures:

- Reorient or relocate the receiving antenna.
- Increase the separation between the equipment and receiver.
- Connect the equipment into an outlet on a circuit different from that to which the receiver is connected.
- Consult the dealer or an experienced radio/TV technician for help.

NOTE:

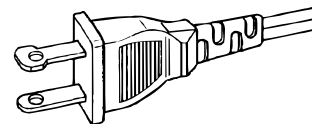
Changes or modifications may cause this unit to fail to comply with Part 15 of the FCC Rules and may void the user's authority to operate the equipment.

IMPORTANT SAFETY INSTRUCTIONS

READ BEFORE OPERATING EQUIPMENT

This product was designed and manufactured to meet strict quality and safety standards. There are, however, some installation and operation precautions which you should be particularly aware of.

1. Read Instructions - All the safety and operating instructions should be read before the appliance is operated.
2. Retain Instructions-The safety and operating instructions should be retained for future reference.
3. Heed Warnings-All warnings on the appliance and in the operating instructions should be adhered to.
4. Follow Instructions-All operating and use instructions should be followed.
5. Cleaning-Unplug this video product from the wall outlet before cleaning. Do not use liquid cleaners or aerosol cleaners. Use a damp cloth for cleaning.
6. Attachments-Do not use attachments not recommended by the video product manufacturer as they may cause hazards.
7. Water and Moisture-Do not use this video product near water-for example, near a bath tub, wash bowl, kitchen sink, or laundry tub, in a wet basement, or near a swimming pool, and the like.
8. Accessories-Do not place this video product on an unstable cart, stand, tripod, bracket, or table. The video product may fall, causing serious injury to a child or adult, and serious damage to the appliance. Use only with a cart, stand, tripod, bracket, or table recommended by the manufacturer, or sold with the video product. Any mounting of the appliance should follow the manufacturer's instructions, and should use a mounting accessory recommended by the manufacturer.
9. Ventilation-Slots and openings in the cabinet are provided for ventilation and to ensure reliable operation of the video product and to protect it from overheating, and these openings must not be blocked or covered. The openings should never be blocked by placing the video product on a bed, sofa, rug, or other similar surface. This video product should never be placed near or over a radiator or heat register. This video product should not be placed in a built-in installation such as a bookcase or rack unless proper ventilation is provided or the manufacturer's instructions have been adhered to.
10. Power Sources-This video product should be operated only from the type of power source indicated on the marking label. If you are not sure of the type of power supply to your home, consult your appliance dealer or local power company. For video products intended to operate from battery power, or other sources, refer to the operating instructions.
11. Grounding or Polarization-This video product is equipped with a polarized alternating-current line plug (a plug having one blade wider than the other). This plug will fit into the power outlet only one way. This is a safety feature. If you are unable to insert the plug fully into the outlet, try reversing the plug. If the plug should still fail to fit, contact your electrician to replace your obsolete outlet. Do not defeat the safety purpose of the polarized plug.
12. Power-Cord Protection-Power-supply cords should be routed so that they are not likely to be walked on or pinched by items placed upon or against them, paying particular attention to cords at plugs, convenience receptacles, and the point where they exit from the appliance.
13. Protective Attachment Plug - The appliance is equipped with an attachment plug having overload protection. This is a safety feature. See Instruction Manual for replacement or resetting of protective device. If replacement of the plug is required, be sure the service technician has used a replacement plug specified by the manufacturer that has the same overload protection as the original plug.
14. Outdoor Antenna Grounding-If an outside antenna or cable system is connected to the video product, be sure the antenna or cable system is grounded so as to provide some protection against voltage surges and built up static charges. Section 810 of the National Electrical Code, ANSI/NFPA No. 70-1984, provides information with respect to proper grounding of the mast and supporting structure, grounding of the lead-in wire to an antenna discharge unit, size of grounding conductors, location of antenna-discharge unit, connection to grounding electrodes, and requirements for the grounding electrode. See Figure 1.
15. Lightning-For added protection for this video product receiver during a lightning storm, or when it is left un-attended and unused for long periods of time, unplug it from the wall outlet and disconnect the antenna or cable system. This will prevent damage to the video product due to lightning and power-line surges.
16. Power Lines-An outside antenna system should not be located in the vicinity of overhead power lines or other electric light or power circuits, or where it can fall into such power lines or circuits. When installing an outside antenna system, extreme care should be taken to keep from touching such power lines or circuits as contact with them might be fatal.
17. Overloading-Do not overload wall outlets and extension cords as this can result in a risk of fire or electric shock.
18. Object and Liquid Entry-Never push objects of any kind into this video product through openings as they may touch dangerous voltage points or short-out parts that could result in a fire or electric shock. Never spill liquid of any kind on the video product.



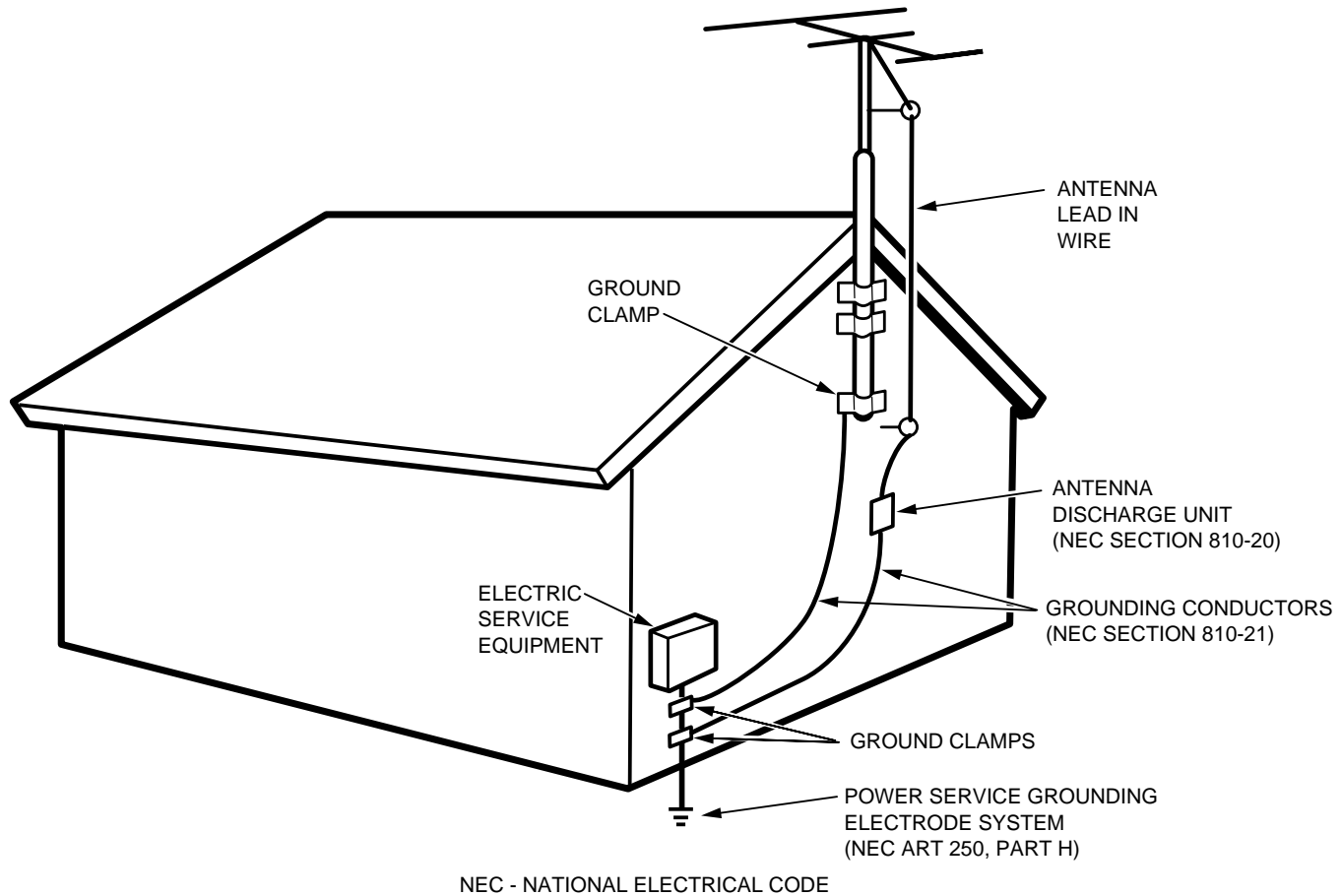
AC POLARIZED PLUG

19. Servicing-Do not attempt to service this video product yourself as opening or removing covers may expose you to dangerous voltage or other hazards. Refer all servicing to qualified service personnel.
20. Damage Requiring Service-Unplug this video product from the wall outlet and refer servicing to qualified service personnel under the following conditions:
 - a. When the power-supply cord or plug is damaged.
 - b. If liquid has been spilled, or objects have fallen into the video product.
 - c. If the video product has been exposed to rain or water.
 - d. If the video product does not operate normally by following the operating instructions. Adjust only those controls that are covered by the operating instructions as an improper adjustment of other controls may result in damage and will often require extensive work by a qualified technician to restore the video product to its normal operation.
 - e. If the video product has been dropped or the cabinet has been damaged.
 - f. When the video product exhibits a distinct change in performance-this indicates a need for service.

21. Replacement Parts-When replacement parts are required, be sure the service technician has used replacement parts specified by the manufacturer or have the same characteristics as the original part. Unauthorized substitutions may result in fire, electric shock or other hazards.
22. Safety Check-Upon completion of any service or repairs to this video product, ask the service technician to perform safety checks to determine that the video product is in proper operating condition.
23. Carts and Stands-The appliance should be used only with a cart or stand that is recommended by the manufacturer.
24. An appliance and cart combination should be moved with care. Quick stops, excessive force, and uneven surfaces may cause the appliance and cart combination to overturn.

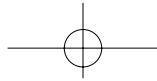
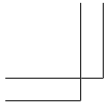


**FIGURE 1
EXAMPLE OF ANTENNA GROUNDING ACCORDING TO
NATIONAL ELECTRICAL CODE INSTRUCTIONS
CONTAINED IN ARTICLE 810 - "RADIO AND TELEVISION EQUIPMENT"**



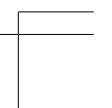
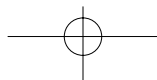
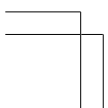
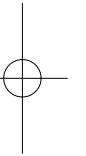
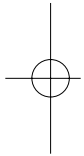
This Class B digital apparatus meets all requirements of the Canadian Interference - Cansing Equipment Regulations.

Cet appareil numérique de la Classe B respecte toutes les exigences du Règlement sur le matériel brouilleur du Canada.



ENGLISH 1

FRANÇAIS 19



GENERAL INFORMATION

ENGLISH

General information

Scope of supply	1
Maintenance	1
Setup	1
Environmental information	1
Trademark acknowledgment	1

Controls.....2

Remote control

Remote control usage	3
Remote control buttons	4
Programming the universal remote control	5

Connectors.....6

Connections

Audio connections	7
Digital Audio connections	7
Video connections	8
Mains	9
Speaker connections	9
Antenna connections	9

System setup

Positioning of the speakers	10
Speaker setup and testing	10
Power handling	10
Headphones	10

Display.....11

Menus

Receiver menu	12
---------------------	----

Source selection

INPUT SELECTOR	13
6 CH input selection	13
Reassigning a source selection	13
Using one source selection for two or more appliances	13

Playback, recording

Playing a source	14
Adjusting the sound	14
Recording from a source	14
Recording from the digital output	14

Surround sound

About surround sound	15
Switching surround sound	15
Surround sound settings	15

Tuner

Tuning to radio stations	16
Switching FM sensitivity	16
Storing radio stations	16
Tuning to stored radio stations	17
Resorting stored radio station	17
Naming radio stations	17
Clearing station names	17

Technical data

Receiver	18
----------------	----

Troubleshooting

Warning	19
Troubleshooting	19

Scope of supply

This receiver is supplied including:

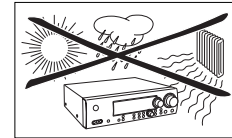
- a remote control
- 2 batteries for the remote control, size AA
- a loop antenna
- a wire antenna
- this instruction booklet

Maintenance

Clean the receiver with a soft, slightly dampened, lint-free cloth. Do not use any cleaning agents as they may have a corrosive effect.



Do not expose the receiver to humidity, rain, sand or excessive heat (caused by heating equipment or direct sunlight).



Setup

If you have stacked the components of your system, the receiver must be on top. Place the receiver on a flat, hard, stable surface. Do not cover any vents and leave 50 cm above and 10 cm left and right of the receiver free for ventilation.


For good reception the loop antenna should not be placed on top of, or beneath VCRs, CD recorders, DVD players, TVs and other radiation sources.

Environmental information

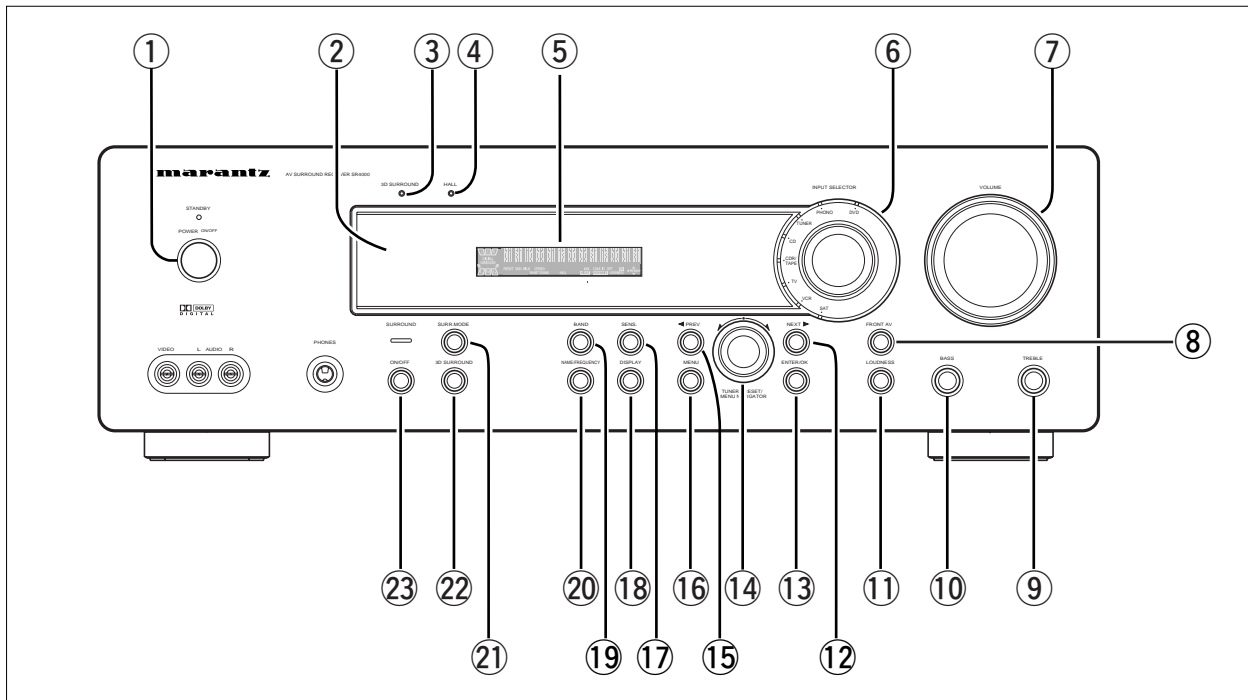
All redundant packing material has been omitted. We have done our utmost to make the packaging easily separable into three mono materials: cardboard (box), polystyrene foam (buffer) and polyethylene (bags, protective foam sheet).

Your set consists of materials which can be recycled if disassembled by a specialized company. Please observe the local regulations regarding the disposal of packing materials, exhausted batteries and old equipment.

Trademark acknowledgment

Manufactured under license from Dolby Laboratories. "DOLBY", "DOLBY DIGITAL", "PRO LOGIC" and the double-D symbol  are trademarks of Dolby Laboratories. Confidential unpublished works. © 1992–1997 Dolby Laboratories. All rights reserved.

CONTROLS



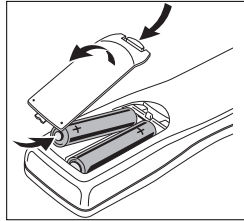
- | | |
|---|--|
| <p>① POWER ON/OFFSwitches the receiver on and off.</p> <p>②Sensor for the infrared remote control.</p> <p>③ 3D SURROUNDControl light for virtual 3D surround.</p> <p>④ HALLControl light for HALL.</p> <p>⑤Display</p> <p>⑥ INPUT SELECTORSelects the different audio and video connectors.</p> <p>⑦ VOLUMEIncreases and decreases the volume level.</p> <p>⑧ FRONT AVSelects the FRONT AV input.</p> <p>⑨ TREBLEAdjusts the treble when used in combination with VOLUME.</p> <p>⑩ BASSAdjusts the bass when used in combination with VOLUME.</p> <p>⑪ LOUDNESSSwitches LOUDNESS on and off.</p> <p>⑫ NEXT ▶TUNER : searches radio stations.
MENU : switches to the next menu level.</p> <p>⑬ ENTER / OKConfirms selected menu values.</p> | <p>⑭ TUNER PRESET / MENU NAVIGATOR
TUNER : switches to the next and previous stored radio station.
MENU : moves upwards and downwards.</p> <p>⑮ ◀ PREV.TUNER: searches radio stations.
MENU: switches to the previous menu level.</p> <p>⑯ MENUSwitches the menu on and off.</p> <p>⑰ SENS.Switches between low and high tuner sensitivity</p> <p>⑱ DISPLAYSwitches the brightness of the display.</p> <p>⑲ BANDSwitches the wavebands of the tuner.</p> <p>⑳ NAME/FREQUENCYSwitches between name and frequency of the display.</p> <p>㉑ SURR. MODESwitches through the different surround effects.</p> <p>㉒ 3D SURROUNDSwitches virtual 3D surround on and off.</p> <p>㉓ SURROUND ON/OFFSwitches the surround sound on and off.</p> |
|---|--|

REMOTE CONTROL

ENGLISH

Remote control usage

Open the battery compartment of the remote control and insert 2 alkaline batteries, type **AA** (R06, UM-3).



Remove batteries if they are flat or if the remote control is not going to be used for a long time.

Batteries contain chemical substances, so they should be disposed of properly.

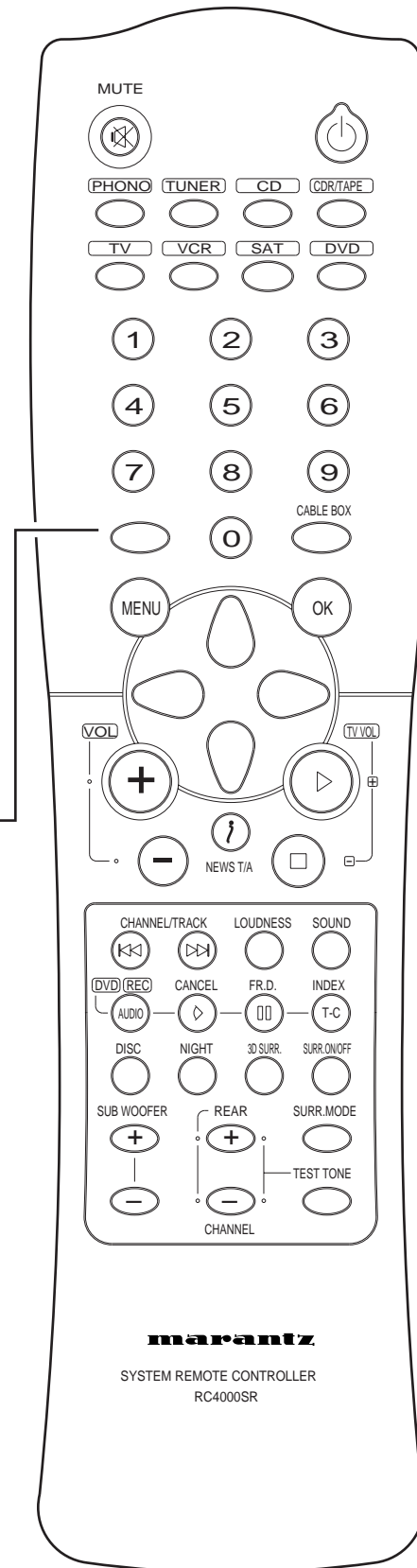
The buttons on the remote control work the same way as the corresponding ones on the receiver.

Important!

You have to press a source button for longer than 2 seconds to switch the sound source on the receiver. Pressing a source button for less than 2 seconds will only switch the remote control to use the commands for the selected product.




The remote control remains tuned to the selected source until another source button on the remote control is pressed. This enables you to operate additional sources (i. e. winding a tape) without changing the source on the receiver.

This button is invalid.



REMOTE CONTROL

Remote control buttons

⊗ MUTE	Mutes the sound of the receiver.	REC, DVD AUDIO	CDR, VCR: Starts recording. DVD: Switches audio tracks.
⏻	Switches the receiver to standby.	CANCEL, DVD 	CD, CDR, SAT, VCR: Clears a program, cancels selections. DVD: Switches the view angle.
PHONO, TUNER, CD, CDR/TAPE, TV, VCR,SAT, DVD	Switches the remote control to the commands of the different products. Selects the sources if pressed longer than 2 seconds. SAT only works with <i>digital</i> satellite receivers.	FR.D., DVD 	TUNER: Switches to FREQUENCY DIRECT. CD, CDR, VCR, DVD: Pauses playback.
1-0	Keys in numbers for tracks, stations or frequencies. Numbers consisting of two figures must be keyed in within 2 seconds.	INDEX, DVD T-C	VCR: Switches the index search on and off. SAT: Switches the themes on and off. DVD: Switches between title and chapter.
CABLE BOX	(USA only) Switches the remote control to the cable box codes.	DISC	CD-, CDR-, DVD-Changers: Switches to the next disc.
MENU	Switches the menu on and off.	NIGHT	Switches NIGHT MODE on and off.
OK	Confirms menu options.	3D SURR.	Switches virtual 3D surround on and off.
Arrow buttons	TUNER: Moves in the menus. Right/left arrows are tuning up/down. CD,CDR: Left/right arrows are searching backwards / forwards, up/down arrows are selecting the next/previous track.	SURR. ON/OFF	Switches SURROUND SOUND on and off.
+ VOL	Increases the receiver volume.	+ / - SUBWOOFER	Increases/decreases the subwoofer volume.
- VOL	Decreases the receiver volume.	+ / - REAR	Increases/decreases the volume of the rear speakers. While test tone is on, the volume of the speakers you are hearing can be increased/decreased with these buttons.
 NEWS T/A	TUNER: Without function. TV: Switches teletext on and off. SAT: Switches the information text on and off.	SURR. MODE	Scrolls through the different surround modes.
▷+ TV VOL	Increases the TV volume. CD, CDR, VCR, DVD: Starts playback.	TEST TONE	Switches the test tone on and off. While test tone is on, the volume of the speakers you are hearing can be increased/decreased with + / - REAR.
◻- TV VOL	Decreases the TV volume. CD, CDR, VCR, DVD: Stops playback.		
◀◀ CHANNEL/TRACK	Selects the previous preset tuner station. VCR: Rewinds the tape. CD, CDR, DVD: Selects the previous track. TV: Selects the previous channel.		
▶▶ CHANNEL/TRACK	Selects the next preset tuner station. VCR: Fast forwards the tape. CD, CDR, DVD: Selects the next track. TV: Selects the next channel		
LOUDNESS	Switches LOUDNESS on and off.		
SOUND	Scrolls through the different smart sounds.		

REMOTE CONTROL

ENGLISH

Programming the universal remote control


You can identify the universal remote control by the inscription Multibrand / Universal.

The universal remote control must be programmed to use the codes for your appliances of different brands. This is done by keying in a 4-digit code or by scanning the codes until the correct one is found. We recommend to using the 4-digit code. This method is faster and more reliable. The code scanning method should be used only if you cannot find the code for one of your appliances. The codes are listed at the end of this book.

Important!

Use the remote control buttons for programming, not the buttons of the receiver or other appliances.




Programming with the 4-digit code

- 1 Keep the source button for the appliance which should be controlled and  pressed for 3 seconds.
- 2 Key in the 4-digit code for the appliance (codetable at the end of the booklet).

Notes:

- If more than 4 digits are entered, the remote control will recognize only the ones keyed in first.
- If you do not key in a code within 30 seconds the remote control will switch off the programming function without changing the code.
- To program a new appliance, simply overwrite the old code by entering a new one.

Scanning the codetable


- 1 Switch on the appliance which should be controlled.
 - 2 Keep the source button for the appliance which should be controlled and  pressed for 3 seconds.
 - 3 Press and release  again.
 - The remote control sends the codes for channel up or standby (depending on the selected source) for one brand after the other.
 - 4 As soon as the appliance reacts – switches to the next channel or to standby – press  to confirm the code.
 - The identified code will be used.
- If the set does not react within 2 minutes, the code for this appliance is not stored in the remote control. The code of the remote control will remain unchanged.

Note: When taking out the batteries of the remote control for more than 1 minute the codes must be reprogrammed.

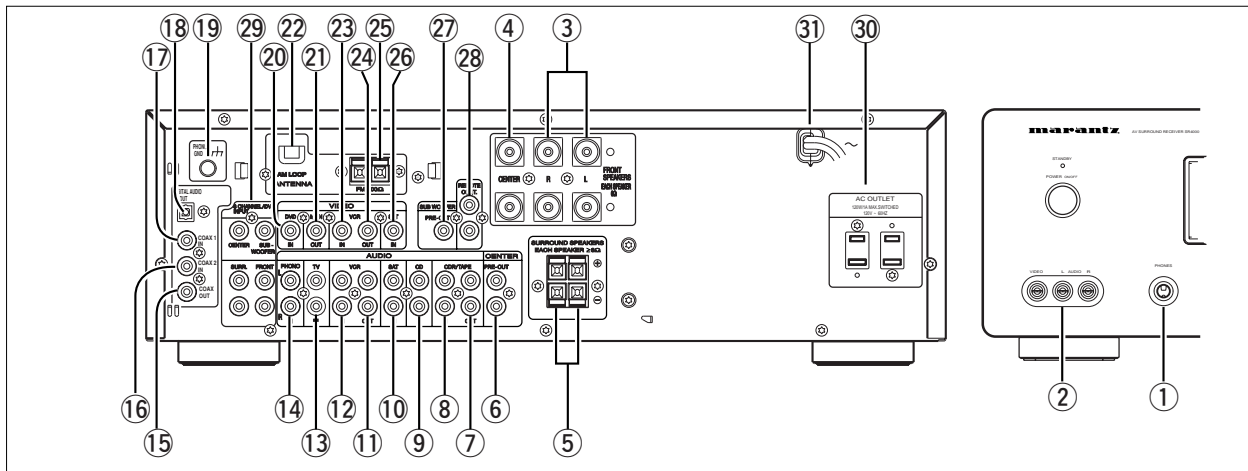
Once you have found and tested the codes for your various appliances, you may want to write them down here.

PHONO.....
 CD.....
 CDR/TAPE.....
 TV
 VCR
 SAT
 DVD
 CABLE BOX

Resetting the remote control

- 1 Keep one of the source buttons and  pressed for 3 seconds.
- 2 Key in the 3-digit code 981.
 - The remote control is now reset to all its original Marantz codes.

CONNECTORS

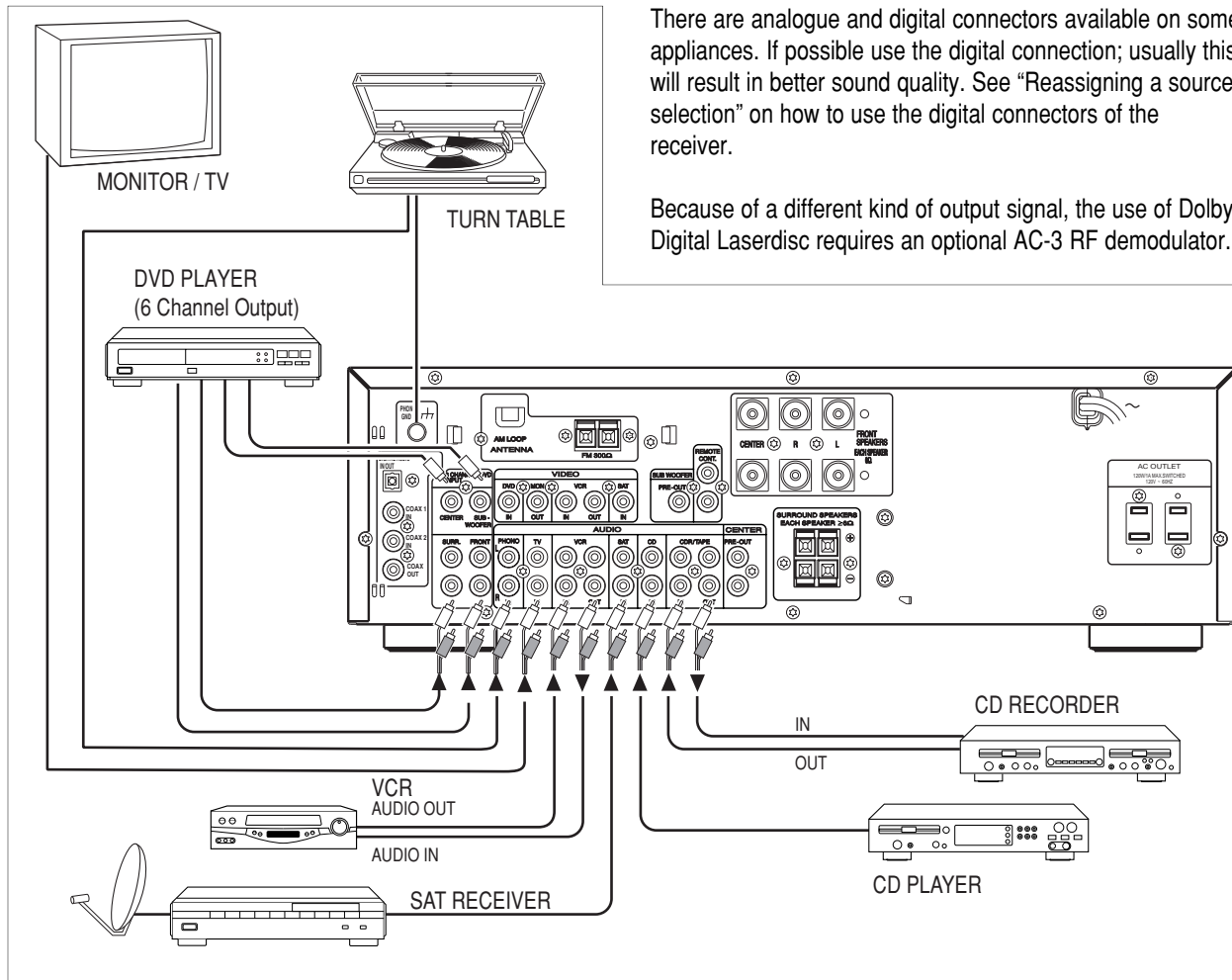


Connectors	Connectors name	Connect to:
6.3 mm headphone socket at the front	① PHONES	A headphone with a 6.3 mm plug.
Audio and video inputs at the front	② FRONT AV	Audio and video out sockets of appliances such as video cameras and game consoles.
FRONT SPEAKERS	③ R, L	Right and left front speaker.
	④ CENTER	Center speaker.
SURROUND SPEAKERS	⑤ R, L	Right and left surround speaker.
AUDIO IN/OUT	⑦ CDR/TAPE OUT	Input of a CD recorder or a tape deck.
	⑧ CDR/TAPE IN	Output of a CD recorder or a tape deck.
	⑨ CD IN	Output of a CD player.
	⑩ SAT IN	Output of a satellite system.
	⑪ VCR OUT	Input of a video recorder.
	⑫ VCR IN	Output of a video recorder.
	⑬ TV IN	Output of a TV.
	⑭ PHONO IN	Output of a turntable with MM coil.
	⑰ PHONO GND	Ground cable of a turntable.
DIGITAL AUDIO IN/OUT	⑮ COAX OUT	Coaxial input of digital appliances such as CD recorders or MD recorders.
	⑯ COAX 2 IN	Coaxial output of digital appliances.
	⑰ COAX 1 IN	Coaxial output of digital appliances.
	⑱ OPTICAL IN	Optical output of digital appliances such as DVD players, CD players, CD recorders or MD players.
6-channel input	⑲ 6 CHANNEL/DVD INPUT	6-channel output of appliances such as DVD or Laserdisc players.
VIDEO IN/OUT	⑳ DVD IN	Output of a DVD player.
	㉑ MON OUT	Input of a monitor (e. g. the TV).
	㉓ VCR IN	Output of a video recorder.
	㉔ VCR OUT	Input of a video recorder (for recording).
	㉖ SAT IN	Output of a satellite system..
Antenna connectors	㉒ AM LOOP	Frame antenna supplied.
	㉕ FM 300	Wire antenna supplied or exterior antenna.
Preamplified outputs	⑥ CENTER PRE-OUT	Input of an amplifier of center speaker.
	⑦ SUBWOOFER PRE-OUT	Input of a powered subwoofer.
Remote control bus	⑲ REMOTE CONT.	Connect to a component equipped with MARANTZ remote control jack
Mains outlets	⑳ AC OUTLET	Supplies same voltage as mains. Up to 100 W total permitted load.
Mains lead	㉑	After all other connections have been made, connect the mains lead to the wall socket.

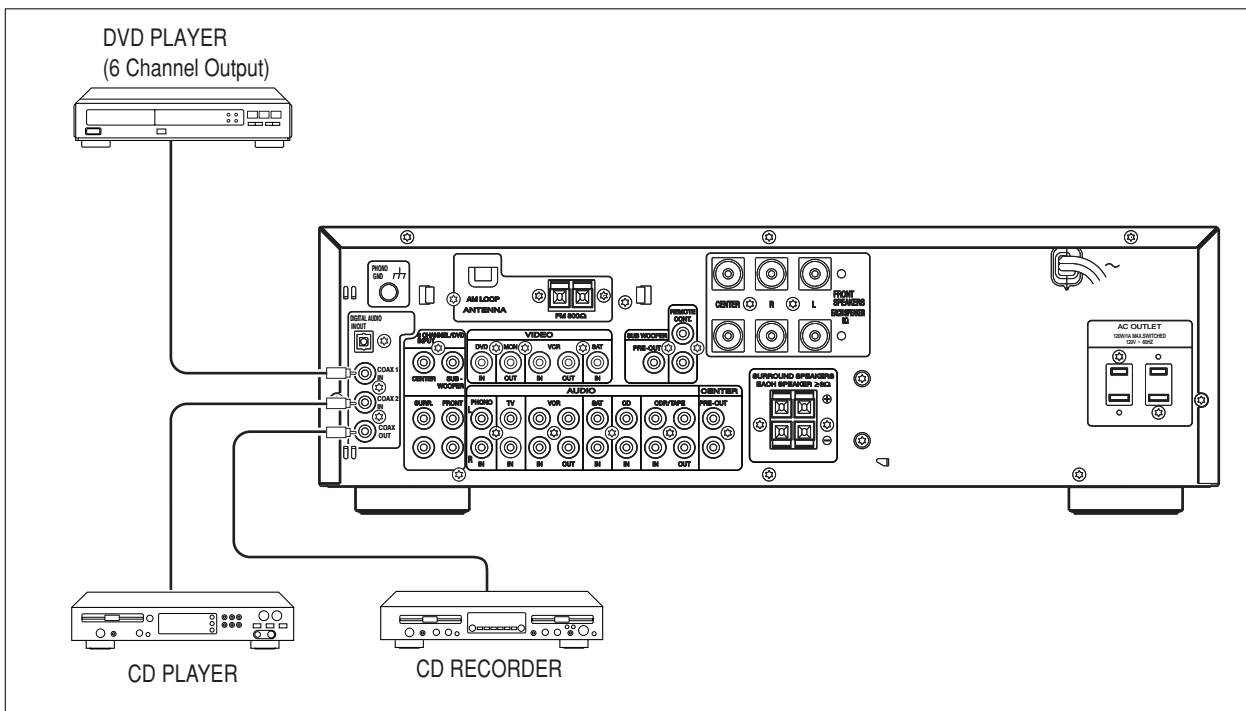
CONNECTIONS

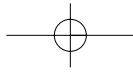
ENGLISH

Audio connections



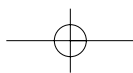
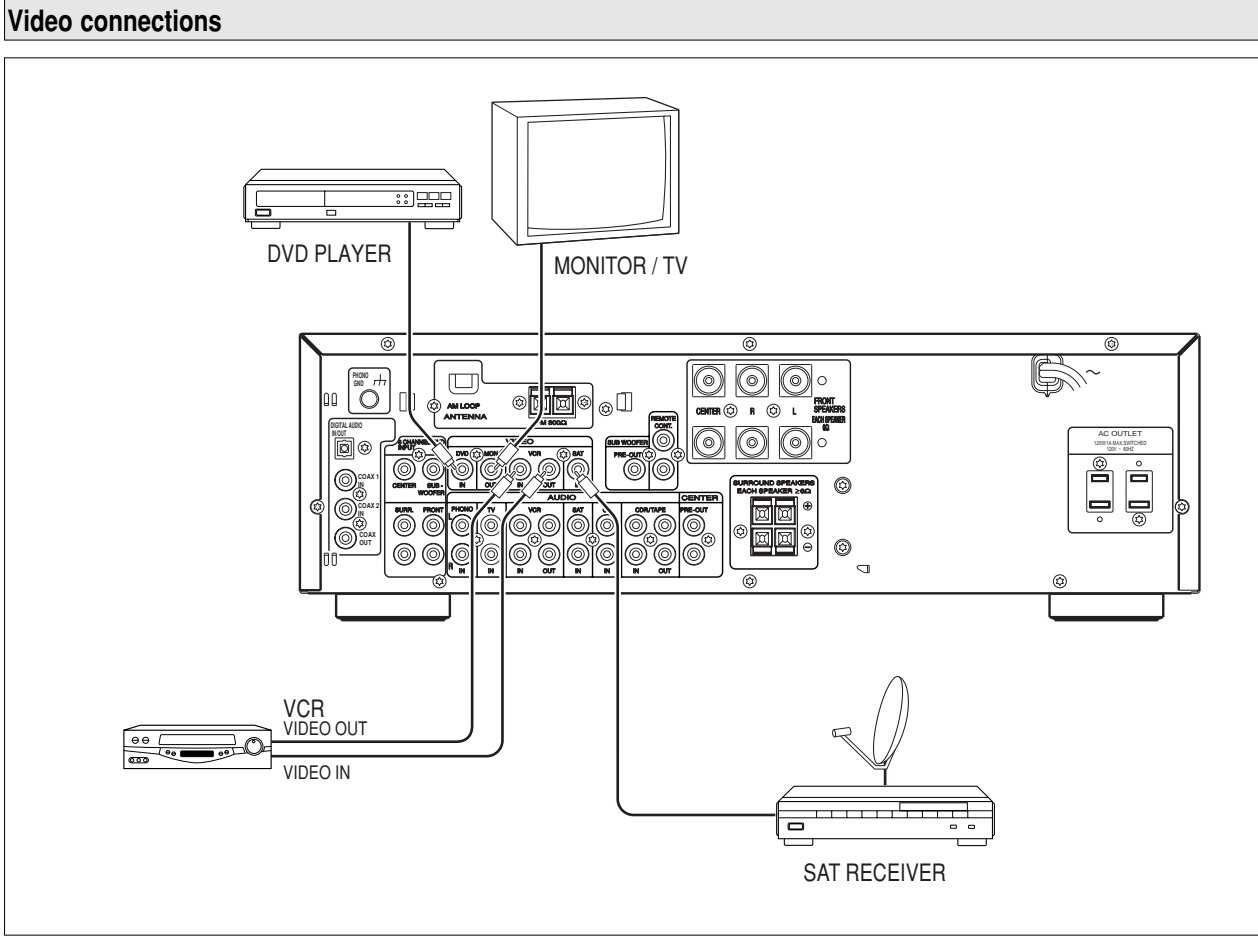
Digital Audio connections





CONNECTIONS

ENGLISH



CONNECTIONS

ENGLISH

Mains

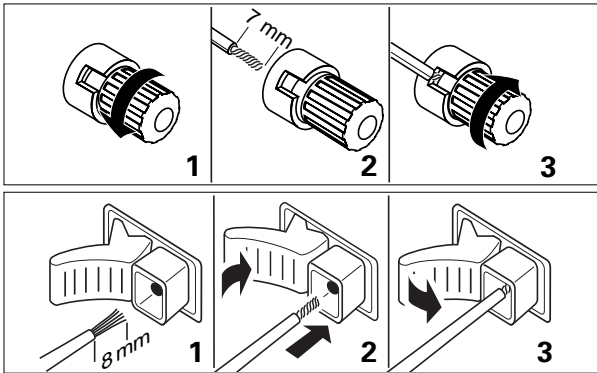
The type plate is located on the rear of the receiver.

- 1 Check whether the mains voltage as shown on the type plate corresponds to your local mains voltage. If it does not, consult your dealer or service organization.
- 2 Connect the mains cable to the wall socket.

To disconnect the set from the mains completely, remove the mains plug from the wall socket.

Speaker connections

Some of the speaker connections on the receiver are screw connectors and some are click-fit connectors. Use them as shown below.



- 1 Always connect the coloured (or marked) wire to the red terminal and the black (or unmarked) wire to the black terminal.

2 Connect:

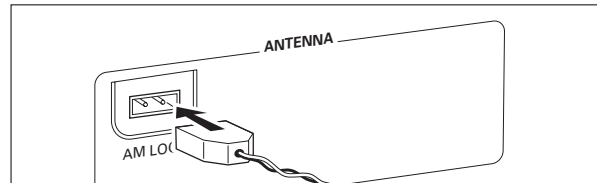
- Left front speaker to L
- Right front speaker to R
- Center speaker to CENTER
- Left surround speaker to SURROUND L
- Right surround speaker to SURROUND R

Antenna connections

AM antenna

The loop antenna supplied is for indoor use only. Position the antenna as far away as possible from the receiver, the TV, the cables, a DVD player, a VCR and other radiation sources.

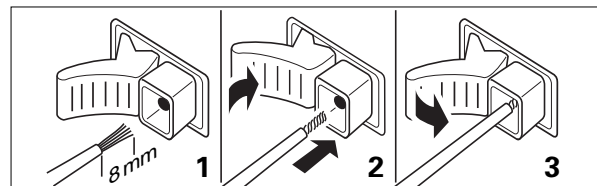
- 1 Fit the plug of the frame antenna to AM LOOP as shown below.
- 2 Turn the antenna for optimum reception.



FM antenna

The wire antenna supplied can only be used to receive nearby stations. For better reception we recommend using a cable antenna system or an outdoor antenna.

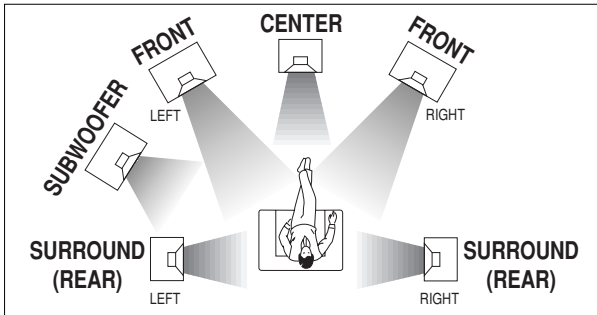
- 1 Open the FM 300 click-fits by pushing the lever down as shown below.
- 2 Insert each wire of the antenna into one hole.
- 3 Close the click-fits using the lever.
- 4 Move the antenna in different positions for optimum reception.



The unit complies with the FCC-Rules, Part 15. Operation is subject to the following two conditions:

1. *This device may not cause harmful interference, and*
2. *This device must accept any interference received, including interference that may cause undesired operation.*

SYSTEM SETUP



Positioning of the speakers

General hints for positioning

Avoid positioning the speakers in a corner or on the floor as this will boost the bass tones too much. Placing the speakers behind curtains, furniture, etc. will reduce the treble response. The listener should always be able to "see" the speakers.

Each room has different acoustic characteristics and the positioning possibilities are often limited. You can find the best position for your speakers by referring to the picture above.

As a minimum we recommend 5 speakers (2 front, a center, 2 surround) for good surround sound. It is possible to reproduce some kind of surround sound with fewer speakers. This is done by redirecting the signals which are foreseen for the missing speakers to the existing ones. See "Menus" on how to set up the receiver correctly for the number and size of the speakers used.

Positioning the front speakers

The front speakers should be placed right and left in front of the listening position like usual stereo speakers.

Positioning the center speaker

The center speaker should be placed in the center between the two front speakers, e. g. underneath or on top of the TV. The best height for the center speaker is the height of the listener's ears (while seated).

Positioning the surround speakers

The surround speakers should face each other and be in line with, or slightly behind the listener.

Positioning the subwoofer

A subwoofer can be used to enhance the bass performance of your system dramatically. The subwoofer can be positioned anywhere in the room, because it is not possible to locate the source of deep tones. Nevertheless, you should not place the subwoofer in the middle of a room, since the bass could be severely weakened. Do not place any object on the subwoofer.

Speaker setup and testing

The relative volume of the speakers must be adjusted for optimal surround sound. You should be at your usual listening position when adjusting the speaker volume. See "Receiver menus" on how to set up the receiver for the used speakers.

- 1 Press POWER ON / OFF to switch on the receiver.
- 2 Press TEST TONE on the remote control.
→ A test tone coming from the different speakers, except the subwoofer, is heard.
- 3 Press + / - REAR on the remote control to increase/decrease the volume of the actual speaker. The best result is achieved when all speakers have equal volume in the listening position.
- 4 Press TEST TONE on the remote control.
→ The test tone stops.

Note: If you are not completely satisfied with the volume settings, we recommend making minor adjustments to them during surround sound playback.

Power handling

If the receiver is used at very high power, it can produce distortions which may seriously damage your speakers. If distortions occur, reduce the volume and the tone controls to a level where the sound is acceptable again.

To avoid overheating of the set a safety circuit has been built in. Therefore your set may disconnect under extreme conditions. If this happens, switch the set off and let it cool down before reusing it.

Headphones

Connecting headphones to PHONES will switch off the speakers. The receiver switches to STEREO and surround sound will be reduced to a stereo signal which is reproducible by standard headphones.

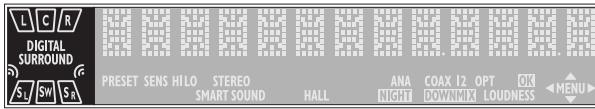
Disconnecting the headphones switches on the speakers again. If you wish to enjoy surround sound again, switch the receiver back to surround sound.

DISPLAY

Display

The display of the receiver is divided into 3 sections, which are to be used for the following:

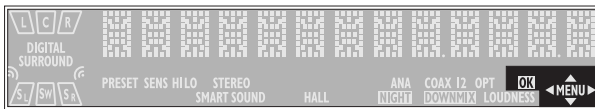
Speaker diagram



A rectangle with a letter in it shows that a speaker has been selected in the setup menu. However, the subwoofer indicator will only light when a subwoofer signal is available. If only a letter is shown, this speaker is not used and its sound is reproduced by the other speakers.

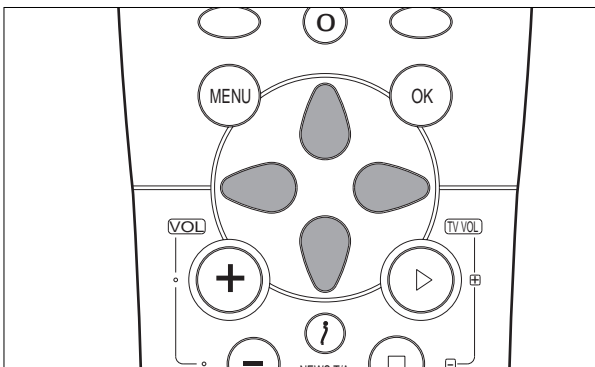
-virtual 3D surround
- SURROUND**surround sound is reproduced
- DIGITAL SURROUND**digital surround sound is reproduced
- L, R**front left and right speaker
- C**center speaker
- SL, SR**surround speakers
- SW**subwoofer

Menu indication

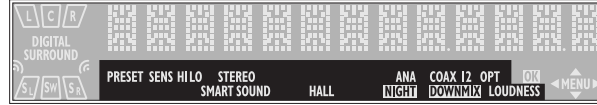


These signs show you if the menu is on or off and indicate in which direction you may move.

- MENU**Menu is on.
-You may move backwards to the previous menu topic using **PREV.** ("left" key on the remote control).
-You may move up in an option list using **MENU NAVIGATOR** ("up" key on the remote control).
-You may move down in an option list using **MENU NAVIGATOR** ("down" key on the remote control).
-You may move forward to the next menu topic using **NEXT** ("right" key on the remote control).
- OK**You may confirm the displayed value.



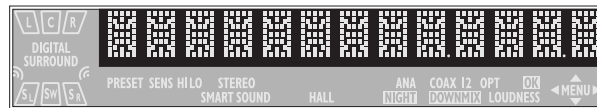
Status lights



Signs showing you various settings and information about the status of the receiver.

- PRESET**Tuner is tuned to a preset radio station.
- SENS HI**Tuner is switched to high sensitivity.
- SENS LO**Tuner is switched to low sensitivity.
- STEREO**An FM station is being received in stereo.
- SMART SOUND**One of the preset sound settings of the receiver is being used.
- HALL**HALL effect is on.
- ANA**Analogue input is being used for the playing source.
- NIGHT**NIGHT MODE is on.
- COAX 1**Coaxial digital input COAX 1 is being used for the playing source.
- COAX 2**Coaxial digital input COAX 2 is being used for the playing source.
- DOWNMIX**Incoming multi channel signals are being reduced to fewer output signals (depending on the number of speakers).
- OPT**Optical digital input OPTICAL IN is being used for the playing source.
- LOUDNESS**LOUDNESS is switched on.

Information area



This area is used for feedback of the receiver, tuner frequencies, menu options, values and scrolling text messages.

MENUS

Receiver menu

The receiver is equipped with a menu system. The menu is used for the setup of the receiver. The different menu options are related to each other in a logical way. Let's assume you have no center speaker connected, and therefore switched CENTER SPEAKER to NO. If you try to use VOL CENTER, a message will be scrolled that this is not possible (INSTALL CENTER SPEAKER).

The menu always works the same way. Arrows in the display show you the possible moving directions.

- 1 Press MENU.
→ MENU, and # EFFECTS is displayed.
- You can exit the menu at any time by pressing MENU.
- 2 Turn MENU NAVIGATOR until the desired option (or a value) is displayed.
- 3 Press NEXT ► to choose the displayed option (or ENTER / OK to confirm a value).
- You can leave any option (values remain unchanged) by pressing ◀ PREV.

Menu structure

EFFECTS

Switches sound effects.

3D SURR

virtual 3D surround: 0...100 %

VOL BALANCE

Adjusts the relative volume balance between the connected speakers.

TEST TONE

Test tone: on/off

VOL FRONT-L

Volume front left speaker: -50...+50

VOL FRONT-R

Volume front right speaker: -50...+50

VOL CENTER

Volume center speaker: -50...+50

VOL REAR-L

Volume rear left speaker: -50...+50

VOL REAR-R

Volume rear right speaker: -50...+50

VOL SUBWOOFER

Volume subwoofer: -50...+50

SPEAKER SETUP

Selects the used speakers.

SUBW PRESENT

Subwoofer present: yes/no

CENTER SPEAKER

Center speaker present: yes/no

REAR SPEAKER

Rear speakers present: yes/no

SPEAKER SIZES

Chooses the speaker sizes of the used speakers, for optimal sound reproduction. LARGE indicates a speaker which can reproduce frequencies lower than 50 Hz. If SUBW PRESENT is set to NO, FRONT SIZE can only be set to LARGE. If FRONT SIZE is set to SMALL, CENTER SIZE can only be set to SMALL and consequently a subwoofer must be connected.

SUBW PRESENT

Subwoofer present: yes/no

FRONT SIZE

Left and right front speakers: small/large

CENTER SIZE

Center speaker: small/large

REAR SIZE

Rear speakers: small/large

SPK DISTANCE

Distance between the usual listening position and the speakers. This defines the delay time for the surround sound.

DISTANCE L/R

Distance to front speakers: 1...10 m (3...30 ft)

DISTANCE CNTR

Distance to center speaker: 1...10 m (3...30 ft)

DISTANCE REAR

Distance to rear speakers: 1...10 m (3...30 ft)

SELECT INPUT

Assigns the audio input connectors to the different source selections chosen with INPUT SELECTOR (see "SOURCE SELECTION" for details).

COAX 1

Digital coaxial input 1, COAX 1 IN

COAX 2

Digital coaxial input 2, COAX 2 IN

OPT

Digital optical input, OPTICAL IN

SAT IN

Analogue audio input SAT IN

VCR IN

Analogue audio input VCR IN

TV IN

Analogue audio input TV IN

CDR IN

Analogue audio input CDR IN

CD IN

Analogue audio input CD IN

6CH IN

Analogue audio input 6 CHANNEL IN

TUNER

Setup for preset radio stations (see TUNER for details).

AUTO INSTALL

Stores radio stations automatically

MAN INSTALL

Stores radio stations manually

GIVE NAME

Allows to assign names to stored radio stations

RESHUFFLE

Resorts stored radio stations

SOURCE SELECTION

ENGLISH

INPUT SELECTOR

When selecting a source by turning INPUT SELECTOR, the audio and video inputs with the corresponding name are activated. The incoming signal is reproduced by all audio and – if the source includes a video signal – video outputs of the receiver.

Source selectedConnectors used

DVD	COAX 1 digital audio input and DVD IN video input
PHONO.....	PHONO IN audio input
TUNER	The tuner part of the receiver is used, all inputs are switched off.
CD.....	CD IN audio input
CDR/TAPE.....	CDR/TAPE IN audio input
TV	TV IN audio input and no video input
VCR	VCR IN audio input and VCR IN video input
SAT.....	SAT IN audio input and SAT IN video input

6 CH input selection

The 6 channel input connectors can be assigned to any of the available sources (excluding TUNER and PHONO). The assignment can be done via the SELECT INPUT option in the menu.

See below for more details.

Reassigning a source selection

If a source is selected with INPUT SELECTOR the standard audio input is used. To change this, the source selection must be reassigned to another audio input.

Example: Reassigning **CD** from the analogue CD IN audio input to the digital COAX 2 IN audio input.

- 1 Choose **# SELECT INPUT** from the menu and press **NEXT ▶**.
- 2 Turn INPUT SELECTOR to select the source which should be reassigned (e. g. **CD**).
→ The name of the source is displayed and the light of the source flashes.
- 3 Turn MENU NAVIGATOR to select the input connectors which should be used (e. g. **CD** → **COAX 2**).
- 4 Press ENTER / OK to confirm your selection.
→ **STORE** is displayed briefly.
- 5 This source selection is now using the chosen audio input (e. g. **CD** uses the COAX 2 IN input connectors, **COAX 2** lights when switching to CD).

Using one source selection for two or more appliances

You may assign more than one source to a source selection. This can be useful when products are connected one after the other in a chain.

Example: A VCR is connected to the TV but only the TV is connected to the receiver. Both INPUT SELECTOR settings, TV as well as VCR, have to use the TV input connectors.

- 1 Choose **# SELECT INPUT** from the menu and press **NEXT ▶**.
- 2 Turn INPUT SELECTOR to select the source which should be reassigned (e. g. **VCR**).
→ The name of the source is displayed and the light of the source flashes.
- 3 Turn MENU NAVIGATOR to select the input connectors which should be used (e. g. **VCR** → **TV IN**).
- 4 Press ENTER / OK to confirm your selection.
→ **STORE** is displayed briefly.
- 5 This source selection is now using the chosen audio input (e. g. **VCR** uses the TV IN input connectors, **VCR (TV IN)** is displayed briefly when switching to VCR).

PLAYBACK, RECORDING

Playing a source

- 1 Press POWER ON / OFF to switch on the receiver.
- 2 Turn INPUT SELECTOR to select a source.
→ The name of the source is displayed.
- You can select the FRONT AV input by pressing FRONT AV.
- 3 Start playback of the source as usual.

Adjusting the sound

- Turn VOLUME to adjust the volume.
→ VOLUME and the volume level between 0 and 50 is displayed.
- 1 Press BASS or TREBLE.
→ BASS or TREBLE and the actual value are displayed briefly. Then TURN VOLUME knob TO CHANGE is scrolled.
 - 2 Turn VOLUME to adjust the bass or treble.
→ BASS or TREBLE and the actual value are displayed.

Note : If VOLUME is not turned within 5 seconds or if any other control is used, the bass or treble adjustment is switched off.

- Press SOUND on the remote control to scroll through the built-in smart sounds: MOVIE , SPEECH , MUSIC , MULTIMEDIA and PERSONAL . (PERSONAL is the userdefined bass and treble setting.)
→ SMART SOUND is displayed and the name of the chosen sound profile is scrolled once if smart sound is on.
- Press LOUDNESS to switch loudness either on or off.
→ LOUDNESS is displayed if loudness is on.

Recording from a source

If you wish to record from a source you must select it with INPUT SELECTOR. The incoming signal is reproduced by all audio and – if the source includes a video signal – video outputs of the receiver. The sound settings do not affect the recording.

- 1 Turn INPUT SELECTOR (or press FRONT AV) to select the source you want to record from.
→ The name of the source is displayed.
- 2 Prepare the desired recording appliance. It must be connected to one of the outputs of the receiver.
- 3 Start recording on the recording appliance.
- 4 Start the playback of the source as usual.

Notes:

- The audio and video signal of VCR IN is not reproduced by VCR OUT. The same applies to the audio signal of CDR/TAPE IN to CDR/TAPE OUT.
- We recommend not to use the digital output COAX OUT of the receiver to record from an analogue source. Use the analogue output CDR/TAPE instead.

Recording from the digital output

It is possible to connect a digital recorder to the digital output of the receiver. In this way, all signals coming from the digital inputs can be recorded directly on the connected audio recorder. The receiver will also convert all signals coming from the analogue inputs to the digital output.

The receiver can be used to record digitally a multichannel surround sound audio signal (Dolby Digital) from, for example, DVD to CD-R. The receiver will convert the digital multichannel signal into a stereo signal without loss of relevant sound information.



Notes:

- Do not use the 3D SURROUND feature while making digital recordings as this will distort the digital audio signal.
- When recording a Dolby Digital signal, each track must be recorded individually.

SURROUND SOUND

ENGLISH

About surround sound

Surround sound gives you a complete new listening sensation. You will have the feeling of being in the middle of the action, because sound is coming from everywhere around you. Look out for TV broadcasts, audio and video tapes and discs with the  or  marks which are encoded for multichannel surround sound. You should prefer Dolby Digital to get the best out of your receiver.

Notice that DVDs do not always carry full multichannel surround. To be sure that a disc is multichannel encoded consult your dealer.

Most ordinary stereo tapes and discs can be replayed using surround sound settings with good results. If the reproduction is distorted in surround mode, switch to normal stereo mode.

The availability of the various surround sound modes described depends on the number of speakers used and the incoming sound information.

Switching surround sound

With surround sound on, you can switch through the different surround modes. Note that the possibilities are related to speaker setup defined in the receivers menu.

If a digital surround signal is detected, the receiver will scroll either **DOLBY DIGITAL**.

- 1 Press SURROUND ON/OFF to switch on the surround sound.
→ The surround mode in use is scrolled.
- 2 Press SURR. MODE repeatedly to listen to the different surround modes (if available).
→ The chosen mode and the speakers used are displayed. If the incoming multichannel signals are reduced to fewer output signals, **DOWNMIX** is displayed.
- 3 Press 3D SURROUND to switch virtual 3D surround either on or off.
→ A light indicates if virtual 3D surround is on.
- 4 Press SURROUND ON/OFF to switch off the surround sound.
→ **SURROUND OFF** is scrolled.

Surround sound settings

HALL

The sound reproduction is enhanced and a slight echo is added. This gives the impression of being in a large room. Can only be used in stereo mode.

SURROUND

The surround mode enables normal surround sound reproduction with 4 or 5 speakers. Depending on the source material, Dolby Surround Pro Logic, Dolby Digital is reproduced.

PRO LOGIC, DOLBY DIGITAL

In addition to SURROUND, the surround mode used – depending on the source material – will be displayed. In case of digital surround, the sound format AC-3 (for Dolby Digital) will be displayed, followed by the sound channels, available on the source (e. g. DVD).

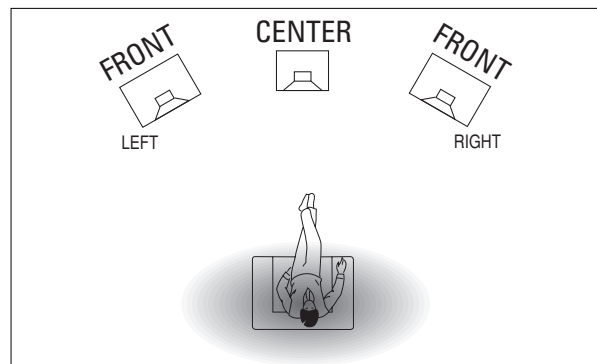
Example: **AC-3 3/2 . 1** Dolby Digital, 3 front channels, 2 surround channels and a subwoofer channel.
AC-3 3/1 . 0 Dolby Digital, 3 front channels, 1 (mono) surround channel without subwoofer signal.

FRONT-3 STEREO

The surround sound is muted. 3 Stereo lets you listen to surround sound without using the surround speakers.

3D SURROUND

The sound of the rear channel is simulated by the front speakers. Surround sound is simulated through the front left, right and center speakers. The position of the listener influences the surround effect. The area where the effect is best is shown in grey.



STEREO

All sound is reproduced and played through the front left and right speakers. This enables standard stereo reproduction.

NIGHT MODE (only on the remote control)

The loud parts of the sound are lowered and the soft passages are raised. You can enjoy surround sound without disturbing sleeping children or neighbours. Night mode only works with Dolby Digital, and only if supported by the source material.

TUNER

Tuning to radio stations

You can search for radio stations by scanning the frequency band. You can also key in the frequency of a known radio station. If an FM station is being broadcast and received in stereo, **STEREO** is shown.

Searching for radio stations

- 1 Turn INPUT SELECTOR to select the tuner.
→ **TUNER** is displayed.
 - 2 Select a waveband by pressing **BAND** repeatedly.
→ The selected waveband is displayed.
 - 3 Keep ◀ or ▶ pressed for approximately 1 second.
→ **SEARCH** is displayed and the tuner tunes to a station with sufficient strength.
 - 4 Repeat this procedure until you find the desired station.
- To fine tune to a weak transmitter, briefly press ◀ or ▶ as often as necessary for optimum reception.

Tuning to a radio station by frequency (with the remote control only)

- 1 Press **TUNER**.
→ **TUNER** is displayed.
- 2 Press **TUNER** again to select a different waveband.
→ The selected waveband is displayed.
- 3 Press **FR. D.**.
→ **_** is displayed.
- 4 Use 1-0 to key in the frequency of a radio station.

Note: Only valid numbers within the frequency range of the tuner can be keyed in.

Switching FM sensitivity

You can switch the tuner to a lower search sensitivity, to search for stations with a strong signal only (FM only).

- 1 Turn INPUT SELECTOR to select the tuner.
→ **TUNER** is displayed.
- 2 Press **SENS.** on the receiver.
→ Either **SENS HI** or **SENS LO** is displayed for 5 seconds.

*Note: While searching for radio stations, the actual sensitivity is displayed. In this case, **SENS LO** means the tuner is only looking for radio stations with a strong signal.*

Storing radio stations

You may store up to 30 radio stations in the memory. The receiver can select and program radio stations by itself or you can choose them yourself.

Automatic programming

- 1 Choose **TUNER** from the menu and press **NEXT ▶**.
- 2 Choose **AUTO INSTALL.** and press **NEXT ▶**.
→ The preset number where programming will start, the waveband and **AUTO** are displayed.
- 3 Turn **TUNER PRESET** to change the preset number where programming should start.
- 4 Use **BAND** to switch to the desired waveband.
- 5 Press **ENTER / OK** to start programming.
→ **AUTO INSTALL.** flashes and all available radio stations are programmed, this may take a few minutes. Programming is done when **AUTO INSTALL.** stops flashing.

Manual programming

- 1 Choose **TUNER** from the menu and press **NEXT ▶**.
- 2 Choose **MAN INSTALL.** and press **NEXT ▶**.
→ A preset number, the waveband and the frequency are displayed.
- 3 Turn **TUNER PRESET** to change to the preset number where the radio station should be stored.
- 4 Tune to the desired radio station (see "Searching for radio stations").
- 5 Press **ENTER / OK** to confirm your selection.
→ **STORE D** is displayed briefly. The radio station is programmed at the chosen preset number.
- 6 Select and store all desired radio stations this way.

TUNER

ENGLISH

Tuning to stored radio stations

- 1 Turn INPUT SELECTOR to TUNER to select the tuner.
→ TUNER is displayed.
- 2 Turn TUNER PRESET to select a preset radio station.
→ PRESET, the preset number and station are displayed.

Resorting stored radio stations

After programming radio stations, you might want to change their sequence. RESHUFFLE allows you to exchange the positions of presets.

- 1 Choose # TUNER from the menu and press NEXT ▶.
- 2 Choose RESHUFFLE and press NEXT ▶.
→ PRESET, a preset number and station are displayed.
- 3 Turn TUNER PRESET to select a preset station.
- 4 Press ENTER / OK to confirm the selection.
→ The selected preset number SWAP (-) and a second preset number are displayed.
- 5 Turn TUNER PRESET to select the other preset station.
- 6 Press ENTER / OK to confirm the exchange.
→ RESHUFFLE is displayed briefly and these two preset numbers are swapped.

Naming radio stations

It is possible to assign a name to any of the preset radio stations.

- 1 Choose # TUNER from the menu and press NEXT ▶.
- 2 Choose GIVE NAME and press NEXT ▶.
→ A preset radio station is displayed.
- 3 Turn TUNER PRESET to select the preset to be renamed.
- 4 Press ENTER / OK to confirm your selection.
→ The existing name or _____ is displayed.
- 5 Turn TUNER PRESET to select a letter and NEXT ▶ or ◀ PREV. to move to the next or previous position.
- 6 After you have entered the entire name, press ENTER / OK to confirm.
→ STORE is displayed and the name is stored.

Clearing station names

- 1 Use the menu option # TUNER, choose GIVE NAME.
→ A preset radio station is displayed.
- 2 Turn MENU NAVIGATOR to select the name to be cleared.
- 3 Press ENTER / OK to confirm your selection.
- 4 Press ◀ PREV. while the first letter is flashing.
→ [L] is flashing to the left of the station name.
- 5 Press ENTER / OK to clear the station name.
Or, if you have changed your mind,
press ◀ PREV. to leave the station name as it is.

TECHNICAL DATA

Receiver

Subject to modification without notice.

General

Power consumption 195 W
 Standby power consumption..... < 2 W
 Dimensions, w × h × d..... 440 × 138 × 394 mm
 Weight..... 9.4 kg

Amplifier part (0.7 % THD, 6 / 8 , 1 kHz)

Output power, stereo mode..... 2 × 100 / 80 W
 Output power, surround mode
 Front..... 2 × 100 / 80 W
 Center 100 / 80 W
 Surround 2 × 50 / 40 W
 Bass ±9 dB at 100 Hz
 Treble ±9 dB at 10 kHz
 Loudness+6 dB at 100 Hz (-30 dB); +3 dB at 10 kHz (-30 dB)
 Total harmonic distortion..... 0.05 % at 1 kHz, 1 W
 Frequency response..... 20–30,000 Hz, ±1 dB
 S/N ratio..... 82 dB
 Stereo separation (1 kHz)..... 45 dB
 Crosstalk (1 kHz)..... -65 dB

Inputs

Linear inputs 250 mV at 47 k
 Front AV..... 250 mV at 22 k
 Phono..... 5 mV at 47 k
 Digital coaxial 75 acc. IEC 958

Outputs

Power supply AC outlets (switched)..... totally max. 120 W
 Linear outputs 250 mV at 1 k
 Digital coaxial 75 acc. IEC 958
 Digital optical toslink
 Subwoofer pre-out 0.8 V at 1 k
 Center pre-out..... 0.8 V at 1 k
 Headphones..... 8–600 (3 V e.m.f., 60)
 Speakers 6

Tuner part

Wave range
 FM..... 87.5–108.0 MHz
 AM..... 530–1,700 kHz
 Sensitivity
 Stereo FM 41 dBf
 Mono FM..... 17 dBf
 Total harmonic distortion
 Stereo FM 0.8 %
 Mono FM 0.9 %
 Frequency response..... 63–12,500 Hz ±1 dB
 S/N ratio
 Stereo FM 55 dB
 Mono FM..... 60 dB
 Channel separation..... 27 dB at 1 kHz

TROUBLESHOOTING

ENGLISH

WARNING

Under no circumstances should you try to repair anything by yourself, as this will invalidate the guarantee. Do not open the set as there is a risk of electric shock.

If a fault occurs, first check the points listed below before taking the speakers for repair.

If you are unable to solve a problem by following these hints, consult your dealer or service center.

PROBLEM	POSSIBLE CAUSE	SOLUTION
No sound	VOLUME is not correctly adjusted.	Adjust the VOLUME.
	Headphones are connected.	Disconnect headphones.
	The wrong source is selected.	Turn INPUT SELECTOR to select the correct source.
No sound on the left or right side	One speaker is wrongly connected.	Connect the speaker properly.
	A speaker cable is damaged.	Replace the cable.
	Volume balance in the receiver menu is wrongly adjusted.	Adjust VOL FRONT-L and VOL FRONT-R in the receiver menu.
Poor sound or no sound at the center or surround speakers	SURROUND mode is not switched on.	Press SURROUND ON/OFF to switch on the surround sound.
	Surround and/or center speakers are not (properly) connected.	Connect the speakers properly.
	Surround and/or center speakers are switched off in the SPEAKER SETUP menu.	Set speaker present to YES.
	A speaker cable is damaged.	Replace the cable.
Poor bass sound	Speakers are not in phase.	Connect the coloured (or marked) wires to the coloured terminals and the black (or unmarked) wires to the black terminals.
Bad sound	Badly matching setting for the given type of music or sound.	Correct the sound settings on the receiver.
Surround sound level is too low or too high	The level of the surround sound is not properly adjusted.	Adjust the level of the surround sound on the receiver.
Center sound level is too low or too high	The sound level of the center channel is not properly adjusted.	Adjust the level of the center channel on the receiver.
Only center speaker is heard in Dolby Surround Pro Logic	A mono signal is reproduced.	Choose a different sound source or switch off surround sound.
Bad radio reception, automatic programming does not work properly	Receiver or antenna is positioned near a radiation source such as a TV, CD player, CD recorder, DVD player, etc.	Change the position of the interfering unit or try to switch it off.

CABLE BOX

ABC	0030, 0035, 0038, 0040, 0028, 0034, 0041, 0044
Allegro.....	0180, 0342
Antronix.....	0049, 0234
Archer	0049, 0180, 0234, 0824
Belcor.....	0083
Bell & Howell	0041
Cable Star.....	0083
Cabletenna	0049
Cableview	0049
Century	0180
Citizen.....	0180, 0342
Colour Voice	0052, 0058
Comtronics.....	0067
Contec	0046
Digi.....	0664
Eastern	0029
Emerson	0824
Everquest.....	0042, 0067
Focus.....	0427
France Telecom.....	0923
GC Electronics.....	0083, 0234
Garrard	0180
Gemini	0269, 0042
General Instrument.....	0303, 0503, 0038, 0837
GoldStar.....	0067, 0171
Goodmind	0824
Hamlin.....	0047, 0036, 0286, 0061
Hitachi.....	0038
Hytex.....	0034
Jasco	0042, 0180, 0342
Jerrold.....	0030, 0039, 0303, 0038, 0041, 0042, 0051, 0503, 0837
Linsay	0467
Magnavox	0054, 0041
Memorex.....	0027
Movie Time	0090, 0183
NAP	0034
NSC	0183, 0090
Novaplex.....	0645
Oak	0046, 0034
Optimus	0048
Panasonic.....	0048, 0134, 0027
Panther	0664
Paragon	0027
Philips	0052, 0058, 0269, 0317, 0054, 0180
Pioneer	0171, 0050, 0560
Popular Mechanics	0427
Proscan.....	0048
Pulsar.....	0027
Quasar.....	0027
RCA	0048
Radio Shack	0824, 0042, 0342, 0910
Realistic	0234
Recoton	0427
Regal	0286, 0047
Regency.....	0029
Rembrandt.....	0038
Runco	0027
SL Marx	0067
Samsung.....	0067, 0171
Scientific Atlanta	0035, 0044, 0504
Seam	0537
Signal.....	0042, 0067
Signature	0038
Sprucer	0048
Starcom	0030, 0042
Stargate	0067, 0042, 0824
Starquest	0042
Sylvania	0028
TFC.....	0337
TV86	0090
Tandy.....	0285
TeleCaption	0248
Televue.....	0067
Texscan	0028
Timeless	0445
Tocom.....	0039, 0040
Toshiba.....	0027
Tusa.....	0042
Unika.....	0234, 0180, 0049
United Artists	0034
Universal.....	0234, 0049, 0083, 0218, 0180
Viewstar	0285, 0054, 0090
Westminster.....	0132
Zenith.....	0027, 0552, 0081, 0035, 0042, 0234
Zentek.....	0427

CD

ADC	0045
Adcom.....	0261, 0182
Aiwa	0151, 0039, 0184
Akai	0183
Anthem	0924
Audio Alchemy	0221
Audio-Technica.....	0197
BSR	0272, 0221
Burmester	0447
California Audio Lab	0056
Carrera.....	0221
Carver	0184, 0206, 0464
Craig	0642
Crown	0149
Curtis Mathes.....	0056
DAK	0272
DBX	0281
DKK	0027
Denon	0030, 0061, 0900
Emerson	0182, 0191, 0332, 0496
Fisher.....	0115, 0206, 0201, 0369
GE.....	0036
Garrard	0307, 0272, 0420, 0447, 0452
Genexxa	0059, 0191, 0332
GoldStar.....	0444
Harman/Kardon	0200, 0184, 0453
Hitachi.....	0059, 0182
JVC	0099, 0682, 0685
Kenwood.....	0055, 0217, 0708, 0853, 0064
Kodak.....	0314
Krell.....	0184
Kyocera.....	0045
LXI	0332
Linn.....	0184
Luxman	0120
MCS.....	0056, 0070

MGA.....0110
 MTC.....0447
 Magnavox.....0184, 0553, 0332
 Marantz.....0184, 0056, 0207, 0462
 McIntosh.....0314
 Mission.....0184
 Mitsubishi.....0110
 NAD.....0046
 NEC.....0261, 0070
 NSM.....0184
 Nakamichi.....0174
 Nikko.....0197, 0191, 0201
 Onkyo.....0128, 0895
 Optimus.....0447, 0495, 0059, 0453, 0206, 0223,
 0464, 0202, 0332, 0064, 0114, 0172,
 0221, 0307, 0369, 0027
 Panasonic.....0056, 0394, 0330, 0779
 Parasound.....0447, 0221
 Philips.....0184, 0314
 Pioneer.....0059, 0495, 0271, 0332
 Proscan.....0080
 Proton.....0184
 QED.....0184
 Quasar.....0056
 RCA.....0080, 0332, 0036, 0182, 0206, 0791
 Realistic.....0182, 0202, 0191, 0206, 0207, 0447
 Rotel.....0184, 0447, 0924
 SAE.....0184
 STS.....0045
 Sansui.....0229, 0184, 0332
 Sanyo.....0114, 0206
 Scott.....0191, 0182, 0332
 Sears.....0332
 Sharp.....0064, 0207, 0888
 Sherwood.....0141, 0207, 0223, 0453
 Shure.....0070
 Sony.....0027, 0212, 0631, 0517, 0632
 Soundesign.....0172, 0452
 Sylvania.....0184
 Tascam.....0447
 Teac.....0420, 0447, 0201, 0207
 Technics.....0056, 0330, 0234
 Toshiba.....0046
 Vector Research.....0221, 0444
 Victor.....0099
 Wards.....0080, 0184
 Yamaha.....0214, 0063, 0197
 Yorx.....0488
 Zenith.....0642

TAPE

Aiwa.....0224, 0227, 0056
 Akai.....0310
 Carver.....0056
 Denon.....0103
 Fisher.....0101
 Garrard.....0335, 0466
 Harman/Kardon.....0209, 0056
 JVC.....0271, 0300
 Kenwood.....0098, 0097, 0260
 Magnavox.....0056
 Marantz.....0056, 0036
 Mitsubishi.....0310
 NAD.....0171

Onkyo.....0162, 0163, 0309
 Optimus.....0247, 0054, 0364, 0466
 Panasonic.....0256
 Philips.....0056
 Pioneer.....0054, 0247, 0126
 Proscan.....0053
 RCA.....0053
 Revox.....0217
 Sansui.....0036, 0056
 Sharp.....0258
 Sherwood.....0364
 Sony.....0270, 0197, 0318
 Teac.....0335, 0316
 Technics.....0256
 Victor.....0300
 Wards.....0054
 Yamaha.....0121, 0124

DVD

Harman/Kardon.....0609
 JVC.....0585
 Kenwood.....0561
 Magnavox.....0530
 Mitsubishi.....0548
 Onkyo.....0530
 Optimus.....0552
 Panasonic.....0517
 Philips.....0566, 0530
 Pioneer.....0552, 0598
 Proscan.....0549
 RCA.....0549
 Samsung.....0600
 Sony.....0560
 Technics.....0517
 Thomson.....0578
 Toshiba.....0530
 Yamaha.....0572, 0517
 Zenith.....0618, 0530

TV

A-Mark.....0030
 AOC.....0079, 0030, 0212, 0046, 0057
 Abex.....0059
 Admiral.....0120
 Adventura.....0073
 Aiko.....0119
 Akai.....0057
 Alaron.....0206
 Allegro.....0747, 0801
 Ambassador.....0204
 Ampro.....0778
 Anam.....0207
 Anam National.....0082
 Archer.....0030
 Audiovox.....0119, 0030, 0207, 0478, 0650
 Aumark.....0087
 Baysonic.....0207
 Belcor.....0046
 Bell & Howell.....0043, 0181
 Bradford.....0207
 Brockwood.....0046
 Broksonic.....0030, 0263, 0490
 CCE.....0064, 0244

CXC	0207	MGA.....	0177, 0046, 0057, 0205
Candle	0213, 0073, 0057, 0083	MTC	0087, 0046, 0057, 0212, 0083
Capehart	0079	Magnavox	0081, 0214, 0051, 0123, 0047, 0213, 0057, 0413, 0206
Carnivale.....	0057	Majestic.....	0043
Carver	0081	Marantz.....	0081, 0064, 0057
Celebrity.....	0027	Matsushita	0078, 0277
Cineral	0478, 0119	Megatron.....	0030, 0172, 0205
Citizen.....	0213, 0073, 0083, 0057, 0066, 0087, 0119, 0307	Memorex.....	0205, 0043, 0083, 0087, 0177, 0181, 0277
Clairtone	0212	Midland	0044, 0059, 0066, 0074, 0078, 0162
Concerto	0083	Minutz	0048
Contec	0184, 0207, 0212	Mitsubishi.....	0177, 0046, 0205, 0120
Craig	0207	Motorola.....	0082, 0120
Crosley.....	0081	Multitech	0244, 0207
Crown	0066, 0207	NAD	0183, 0193, 0205
Curtis Mathes.....	0087, 0057, 0181, 0043, 0066, 0074, 0078, 0081, 0083, 0120, 0172, 0193, 0478, 0493	NEC	0057, 0046, 0083, 0524
Daewoo.....	0119, 0650, 0046, 0651, 0478, 0066	NTC	0119
Daytron	0046, 0066	Nikko.....	0205, 0044, 0074, 0057, 0119, 0181, 0183
Denon	0172	Noshi.....	0045
Dumont	0044, 0046	Onwa	0207
Dwin.....	0747, 0801	Optimus	0277, 0193, 0181
Dynatech.....	0244	Optonica	0120, 0192
Electroband.....	0027, 0212	Orion.....	0263, 0206, 0490
Electrohome.....	0408	Panasonic.....	0078, 0277, 0082, 0028, 0074, 0080, 0081, 0087, 0120, 0172, 0177, 0181, 0183, 0192, 0205
Emerson	0263, 0207, 0205, 0206, 0490, 0204, 0309, 0307, 0651, 0066, 0212, 0650, 0046, 0065, 0181	Penney.....	0074, 0057, 0087, 0048, 0054, 0162, 0045, 0205, 0078, 0066, 0046, 0030, 0059, 0083, 0183
Envision	0057	Philco	0047, 0046, 0057, 0081, 0123, 0172, 0490, 0051, 0213, 0214
Fisher.....	0181, 0186	Philips	0081, 0044, 0047, 0066, 0064, 0027, 0045, 0046, 0048, 0051, 0054, 0079
Fujitsu	0206	Pilot.....	0046, 0057, 0066
Funai.....	0207, 0198, 0206	Pioneer	0193, 0065
Futuretech.....	0207	Portland	0119, 0046, 0066
GE.....	0048, 0054, 0074, 0082, 0078, 0205, 0162, 0309, 0478, 0120	Prism.....	0078
Gibraltar	0044, 0046, 0057	Proscan.....	0074, 0057
Go Video.....	0087	Proton	0493, 0205, 0030, 0079
GoldStar.....	0028, 0205, 0057, 0046, 0059, 0066, 0083	Pulsar.....	0044, 0046
Gradiente	0083, 0080	Quasar	0078, 0082, 0277, 0192
Grundig	0064, 0222	RCA	0074, 0045, 0162, 0046, 0065, 0078, 0117, 0120
Grunpy	0206, 0207	Radio Shack	0192, 0207, 0205, 0057, 0066, 0046, 0181, 0059, 0074, 0083
Hallmark.....	0205	Realistic	0192, 0207, 0181, 0057, 0066, 0205, 0046, 0059, 0083
Harley Davidson	0206	Rhapsody.....	0212
Harman/Kardon	0081	Runco	0044, 0524, 0057
Harvard.....	0207	SSS.....	0046, 0207
Hitachi.....	0172, 0178, 0065, 0083, 0059	Sampo	0057, 0059, 0066, 0079
Infinity	0081	Samsung.....	0087, 0059, 0205, 0046, 0057, 0066, 0083, 0064
Inteq.....	0044	Samsux.....	0066
JBL.....	0081	Sansei.....	0478
JCB	0027	Sansui.....	0490
JVC	0080	Sanyo.....	0181, 0186, 0173
Janeil	0073	Scimitsu	0046
KEC	0207	Scotch.....	0205
KTV.....	0307, 0207, 0212, 0244, 0066, 0057	Scott.....	0263, 0205, 0206, 0207, 0046
Kaypani.....	0079	Sears	0186, 0181, 0173, 0183, 0081, 0083, 0198, 0205, 0074, 0206
Kenwood.....	0057, 0046	Semivox	0207
Kloss.....	0073, 0051		
LG	0083		
LXI	0181, 0205, 0074, 0044, 0081, 0183		
Loewe	0539		
Logik	0043		
Luxman	0083		
MEI	0212		

Semp	0183	Craig	0064, 0074, 0099, 0267, 0298
Sharp	0192, 0120, 0413, 0066, 0184	Curtis Mathes.....	0062, 0068, 0087, 0189
Shogun	0046	Cybernex	0078, 0267
Signature	0043	Daewoo.....	0305, 0588, 0047, 0072
Simpson.....	0213, 0214	Daytron	0047
Sony.....	0027, 0138, 0107	Denon	0069
Soundesign.....	0205, 0207, 0206, 0213	Dynatech.....	0027
Spectricon.....	0030	Electrohome.....	0064
Squareview	0198	Electrophonic	0064
Starlite.....	0207	Emerex	0059
Supre-Macy	0073	Emerson	0211, 0029, 0148, 0236, 0063, 0238, 0305, 0321, 0115, 0235, 0506, 0088, 0239, 0588, 0095, 0322, 0388, 0027, 0064, 0070
Supreme	0027	Fisher.....	0074, 0131, 0081, 0093
Sylvania	0081, 0047, 0123, 0057, 0408, 0051, 0213, 0214	Fuji.....	0060, 0062
Symphonic.....	0198	Funai.....	0027
TMK	0083, 0204, 0205	GE.....	0062, 0087, 0229, 0075, 0267
Tandy.....	0120	Garrard	0027
Tatung.....	0030, 0082	Go Video.....	0459, 0553
Technics	0078, 0277, 0044, 0074	GoldStar.....	0064, 0065
Technol Ace.....	0206	Gradiente	0035, 0027
Techwood	0030, 0078, 0083	HI-Q	0074
Teknika	0213, 0043, 0206, 0046, 0066, 0081, 0207, 0083, 0119, 0177, 0087	Harley Davidson	0027
Telefunken	0083	Harman/Kardon	0108, 0065
Toshiba	0183, 0087, 0181	Harwood	0095, 0099
Tosonic	0212	Headquarter	0073
Totevision	0066	Hitachi.....	0069, 0132, 0027, 0068
Trical.....	0184	JVC	0094, 0035, 0068
Universal.....	0054, 0048	Jensen	0068
Vector Research	0057	KEC	0064, 0305
Victor.....	0080	KLH	0099
Vidikron.....	0081	Kenwood.....	0068, 0094, 0065, 0073
Vidtech.....	0046, 0205	Kodak.....	0062, 0064
Viking	0073	LXI	0064
Wards	0081, 0192, 0205, 0183, 0043, 0047, 0048, 0123, 0138, 0214, 0054, 0107, 0206, 0046, 0057, 0083, 0162	Lloyd's.....	0027, 0235
White Westinghouse....	0651, 0650	Logik	0099
Yamaha	0046, 0057	MEI	0062
Zenith.....	0044, 0043, 0119, 0173	MGA.....	0070, 0088, 0267
Zonda.....	0030	MGN Technology.....	0267
VCR			
Admiral.....	0075	MTC	0027, 0267
Adventura	0027	Magnasonic	0305
Aiko.....	0305	Magnavox	0062, 0108, 0027, 0066, 0176
Aiwa	0334, 0027, 0064	Magnin	0267
Akai.....	0133, 0080, 0088, 0068	Marantz.....	0108, 0065, 0062
American High	0062	Marta.....	0064
Asha.....	0267	Matsushita	0062, 0481, 0189
Audiovox	0064	Memorex.....	0131, 0074, 0027, 0064, 0062, 0075, 0267, 0334, 0073, 0066
Beaumarck	0267	Metz	0033, 0064, 0189, 0323
Bell & Howell	0131	Minolta	0132, 0069
Blaupunkt.....	0033	Mitsubishi.....	0070, 0088, 0094, 0075
Broksonic.....	0211, 0148, 0388, 0029, 0236, 0238, 0322, 0506	Motorola.....	0062, 0075
CCE	0099, 0305	Multitech	0027, 0099
Calix.....	0064	NAD	0085
Canon	0062	NAP	0060, 0061, 0062, 0064, 0066, 0069, 0093, 0132
Capehart.....	0047	NEC	0065, 0067, 0068, 0094, 0131
Carver	0108	Nikko.....	0064
Cineral	0305	Nikon.....	0061, 0280
Citizen.....	0305, 0064	Noblex.....	0267
Colt	0099	Olympus.....	0062
		Optimus	0085, 0075, 0064, 0459, 0131, 0189, 0481
		Optonica	0089

Orion0506, 0322, 0029, 0211
 Panasonic0062, 0104, 0189, 0252, 0481
 Penney0062, 0267, 0064, 0065, 0069, 0067,
 0081
 Pentax0069, 0132
 Philco0062, 0506, 0236
 Philips0108, 0062, 0089
 Pilot0064
 Pioneer0085, 0094
 Portland0047
 Profitronic0267
 Proscan0087, 0229
 Protec0099
 Pulsar0066, 0078
 Quarter0073
 Quartz0073
 Quasar0062, 0189, 0104, 0481
 RCA0087, 0176, 0229, 0069, 0132, 0104,
 0133, 0062, 0075, 0267
 Radio Shack0027
 Radix0064
 Randex0064
 Realistic0074, 0027, 0131, 0075, 0064, 0062,
 0089, 0073, 0093
 Ricoh0061, 0280
 Runco0066
 STS0069
 Samsung0267, 0072, 0080, 0078
 Sanky0066, 0075
 Sansui0506, 0068, 0298, 0027, 0094
 Sanyo0073, 0074, 0131, 0267
 Scott0211, 0148, 0238, 0072, 0237, 0239,
 0070
 Sears0069, 0132, 0081, 0073, 0064, 0074,
 0131, 0027, 0062, 0093
 Semp0072
 Sharp0075, 0089
 Shintom0099
 Shogun0078, 0267
 Signature0062
 Singer0099
 Sony0060, 0061, 0059, 0280, 0062, 0027
 Sunpak0280
 Sylvania0062, 0108, 0027, 0070
 Symphonic0027
 TMK0063, 0235, 0267
 Tatung0068
 Teac0027, 0068
 Technics0062, 0189, 0066, 0087, 0229
 Teknika0027, 0062, 0064
 Thomas0027
 Toshiba0072, 0239, 0237, 0093, 0070
 Totevision0064, 0267
 Unitech0267
 Vector0072
 Vector Research0065, 0067
 Video Concepts0067, 0088, 0072
 Videosonic0267
 Wards0062, 0075, 0089, 0027, 0087, 0074,
 0072, 0267, 0239, 0069, 0099, 0176,
 0108
 White Westinghouse0305
 XR-10000099, 0027, 0062
 Yamaha0065, 0068
 Zenith0066, 0060, 0061, 0027, 0506

SAT

AlphaStar0799
 Astro Industries0122
 BSR0122
 Capetronic0122
 Channel Master0045, 0239
 Chaparral0080, 0236, 0243
 DX Antenna0068
 Drake0091, 0272, 0045
 Echostar0307, 0802, 0175, 0186, 0296
 Expressvu0802
 General Instrument0388, 0896, 0654
 Grundig0200
 HTS0802
 Hitachi0846
 Homecable0265
 Hughes Network Syst. ..0776
 Hytek0122
 IQ0237
 IQ Prism0237
 JVC0802
 Janeil0179
 Jerrold0388, 0654
 Legend0296
 Macom0045
 Magnavox0749, 0751
 Memorex0296, 0751
 Next Level0896
 Panasonic0179, 0728
 Philips0227, 0126, 0749, 0751
 President0101
 Primestar0654, 0388
 Proscan0593
 RCA0593, 0170, 0882
 Radio Shack0593
 Realistic0079
 STS0237, 0068
 Sony0666
 Star Choice0896
 Star Trak0207
 Toshiba0109, 0817
 Uniden0265, 0397, 0079, 0101, 0751, 0103,
 0749
 Zenith0091, 0883, 0272

COUNTRY	COMPANY	ADDRESS
AUSTRALIA	Scan audio Pty. Ltd.	4 Station Street, Thornleigh NSW 2120, Australia
AUSTRIA	Huber & Prohaska GmbH	Taborstraße 95 / Ladestraße 1, Gebäude Hangartner, A-1200 Wien, Austria
BELGIUM	Van der Heyden Audio N.V.	Brusselbaan 278, 9320 Erembodegem, Belgium
BULGARIA	Ariescommerce GmbH	Makedonia Blvd. 16, 1606 Sofia, Bulgaria
CANADA	Lenbrook Industries Limited	633 Granite Court, Pickering, Ontario
CYPRUS	Empire Hifi systems Ltd.	P.O. Box 5604, Nicosia, Cyprus
CZECH REPUBLIC	Audio International	Fugnerova 1, 67801 Blansko, Czech Republic
DENMARK	Hi-Fi Klubben Denmark	Aboulevarden 1, DK-8000 Arhus C., Denmark
DUBAI	V.V. & SONS	P.O. Box 105, Dubai, U.A.E.
ESTONIA	Audio International Baltic	Lo Hu 12, EE0026 Tallin, Estonia
F.Y.R.O.M.	T.P. KODI	ul.Cedomir Kantargiev 21a, Skopje, Former Yugoslavian Republic of Macedonija
FINLAND	Hi-Fi Klubi Finland	Uudenmaankatu 4-6, SF-00120 Helsinki, Finland
FRANCE	Marantz France	A division of Marantz Europe B.V., P.O. Box 301, 92 156 Suresnes Cedex, France
GERMANY	Marantz Deutschland	Hakenbusch 3, 49078 Osnabrück, Germany
GREECE	Adamco S.A.	188, Hippocratous Street, 11471 Athens, Greece
HEADQUARTERS EUROPE:	Marantz Europe B.V.	Building SFF-2, P.O. Box 80002, 5600 JB Eindhoven, The Netherlands
HONG KONG	Marantz Asia Ltd.	Unit 1706, Metroplaza II, 223 Hing Fong Road, Kwai Fong, N.T., Kowloon, Hong Kong
HUNGARY	Infovox Ltd.	Terez Krt.31, 1067 Budapest, Hungary
ICELAND	Radiobudin HF	Skipholt 19, P.O. Box 424, 121 Reykjavik, Iceland
INDIA	Marantz India	c/o Philips India Ltd., Plot 80, Bhosari Industrial Estate Pune - 411026, India
IRAN	Home Co.	5th floor no 878 Philips Building Enghelab ave, P.O. 11365/7844 Tehran, Iran
IRELAND	Marantz Ireland	Clonskeagh, Dublin 14, Ireland
ISRAEL	Elmor Ltd.	52 Heh Beiyar Street, Kikar Hamedina, Tel Aviv, Israel
ITALY	Marantz Italy	Via Casati 23, 20052 Monza (Milano), Italy, Servizio Consumatori 1678-20026, Numero Verde
JAPAN	Marantz Japan Inc.	35-1 Sagami Ohno 7-Chome, Sagamihara-shi, Kanagawa 228-8505, Japan
KOREA	Mk Enterprises Ltd.	#604 Electro-officetel, 16-58, 3GA Hangang-ro, Yongsan-ku, Seoul 140-013 Korea
KUWAIT	alAlamiah Electronics Intl.	P.O. Box 8196, Salmiah 22052, Kuwait
LATVIA	Ace Ltd.	61, LacPlesa Str., Riga LV 1011, Latvia
LEBANON	AZ Electronics S.A., 1,	P.O. Box 11 2833, Beirut, Lebanon
LITHUANIA	A Accapella Ltd.	Ausros, Vartu G5, Pasazo Skg., 2001 Vilnius, Lithuania
MALAYSIA	Wo Kee Hong Electronics Sdn. Bhd.	102 Jalan SS 21/35, Damansara Utama, 47400 Petaling Jaya, Selangordarul Ehsan, Malaysia
MALTA	Doneo Co Ltd.	78 The Strand, Sliema SLM07, Malta
MAURITIUS	SKR Electronics Ltd.	P.O. Box 685, Bell Village, Port Louis, Mauritius
NETHERLANDS	Marantz Trading	A division of Marantz Europe B.V., Building SFF-2, P.O. Box 80002, 5600 JB Eindhoven, The Netherlands
NEW ZEALAND	Scan audio Pty. Ltd.	4 Station Street, Thornleigh NSW 2120, Australia
NORWAY	Hi-Fi Klubben Norway	Lillegrensen 7, N-0159 Oslo, Norway
OMAN	Mustafa & Jawad Trading CO.	P.O. Box 1918, Ruwi, Oman
POLAND	Marantz Polska	Ul. Marszalkowska 45/49, 00-648 Warszawa, Poland
PORTUGAL	Corel2	Comércio de Electrónica Lda., Av. Luís Bivar, No 85 A, 1050 Lisboa, Portugal
PROFESSIONAL EUROPE	Marantz Professional Products	Kingsbridge House, Padbury Oaks, 575-583 Bath Road, Longford, Middlesex UB7 0EH, U.K.
PROFESSIONAL U.S.A.	Marantz Professional Products	Distributed by: Superscope Technologies Inc., 1000 Corporate Blvd. Ste.D, Aurora, Illino
QATAR	Almana & Partners W.W.L.	P.O. Box 49, Doha, Qatar
REUNION	Vision +	180 Rue du Marechal Leclerc, 97400 Saint Denis, Ile de la Reunion
ROMANIA	Alltrom SRL	Soseaua Bucuresti, Ploiesti 10, Sector 1, Bucharest, Romania
RUSSIA	Trade Company SV	Bld. 2, 7 Montazhnaya Street, 107497 Moscow, Russia
SAUDI ARABIA	Ultimate Fidelity	Sameria Comm. Center, Roadah Dist., P.O. Box 7760, Jeddah 21472, Saudi Arabia
SINGAPORE	Forward Marketing (S) Pte. Ltd.	Wo Kee Hong Centre, 29 Leng Kee Road, Singapore 159099, Singapore
SLOVAKIA	Audio International Slovakia	Nam. SNP 10, 96001 Zvolem, Slovakia
SLOVENIA	Bofex	Smartinska 152, HALA V/3, 61000 Ljubljana, Slovenia
SOUTH AFRICA	Coherent Imports (PTY) Ltd.	P.O. Box 1614, Alberton, 1450, South Africa
SPAIN	Marantz Spain	Martinez Villergas 2, Apartado 2065, Madrid 28027, Spain
SWEDEN	Hi-Fi Klubben A.B.	Tegnersgatan 21, S-412 52 Gotenborg, Sweden
SWITZERLAND	Sound Company AG	Postfach, 8010 Zürich, Switzerland
TAHITI	Covecolor	Av. Prince Hinoi, Cours de l'union sacré, P.O. Box 2334, Papeete, Tahiti
TAIWAN	Pai-Yuing Co. Ltd.	6th No 148 Sung Kiang Road, Taipei 10429, Taiwan R.O.C.
THAILAND	MRZ Standard Co. Ltd.	746-750 Mahachai Road, Wangburapa, Bangkok 10200, Thailand
TURKEY	Penta Elektronik	Sanayi Ve Ticaret Ltd. Sti., Selvi Kokak, No. 4/1, Senlikkoy, 34810 Florya, Istanbul, Turkey
U.K.	Marantz Hifi UK Ltd.	Kingsbridge House, Padbury Oaks, 575-583 Bath Road, Longford, Middlesex UB7 0EH, U.K.
U.S.A.	Marantz America Inc.	440 Medinah Road, Roselle, IL 60172, U.S.A.
YUGOSLAVIA	ITM	Ljutice Bogdana la, Belgrade, Yugoslavia
EXPORT	Marantz Trading	A division of Marantz Europe B.V., Building SFF-2, P.O. Box 80002, 5600 JB Eindhoven, The Netherlands

www.marantz.com

Manufactured under license from Dolby Laboratories. "Dolby", and "Pro Logic", are trademarks of Dolby Laboratories. Confidential Unpublished Works. © 1992-1997 Dolby Laboratories, Inc. All rights reserved.

<http://www.marantz.co.jp/>

marantz® is a registered trademark.

Printed in Singapore



99 / 08 MIT 284W851250
3104 215 3618.1