

PowerPro™



Portable PA Owner's Manual

PA919SD Public Address Speaker
PA919PS Powered Companion PA
PA916-SP Non-powered Speaker



Califone® International Inc. 1145 Arroyo Ave., # A • San Fernando, CA 91340 USA
Toll Free 800.722.0500 | Toll Free Fax 877.402.2248
International Customers call 818.407.2400 or Fax 818.407.2405





PowerPro™ Owner's Manual

Thank you for purchasing this PowerPro PA, the most versatile and appropriate portable PA for use in school, business, houses of worship and government facilities.

We encourage you to visit our website to register your PA for its warranty coverage at califone.com/registration, and while there please sign up to receive our enewsletter, and learn more about the complete line of Califone audio visual products including: Portable and installed wireless PA systems, multi-media players & recorders, headphones and headsets, computer peripheral equipment, visual presentation products and language learning materials.

Unpacking

Check carefully for damage which may have taken place during transit. Report any damage claim directly to the freight carrier immediately. Save product(s) and packaging for inspection by the carrier's claim agent. Notify your dealer of the pending claim.

Warranty Registration

Please register for your 6-year warranty online at www.califone.com/registration to activate.

Service Repairs

Should your unit require repair contact the dealer or Califone Service Department at: (800) 722-0500 to obtain a Return Authorization (RA) number. After receiving the RA from Califone then ship the unit to Califone prepaid, writing the RA visibly on the outside of the box.

Contents

- a) PowerPro PA
- b) Power Cord
- c) Operation Manual
- d) RC-300 Remote Control With 2 AAA Alkaline Batteries

Also included may be one or more of the following optional items depending on which Power Pro package is purchased:

- Q319 Handheld 16-Channel Wireless UHF Microphone
- M319 16-Channel Wireless UHF Beltpack Transmitter
- LM-316 Lapel Microphone for the M319
- CM-316 Flexible Collar Microphone for the M319
- HBM-316 Headband Microphone for the M319
- PADM-515 High Quality Handheld Wired Microphone

PowerPro™ PA919SD SPECIFICATIONS

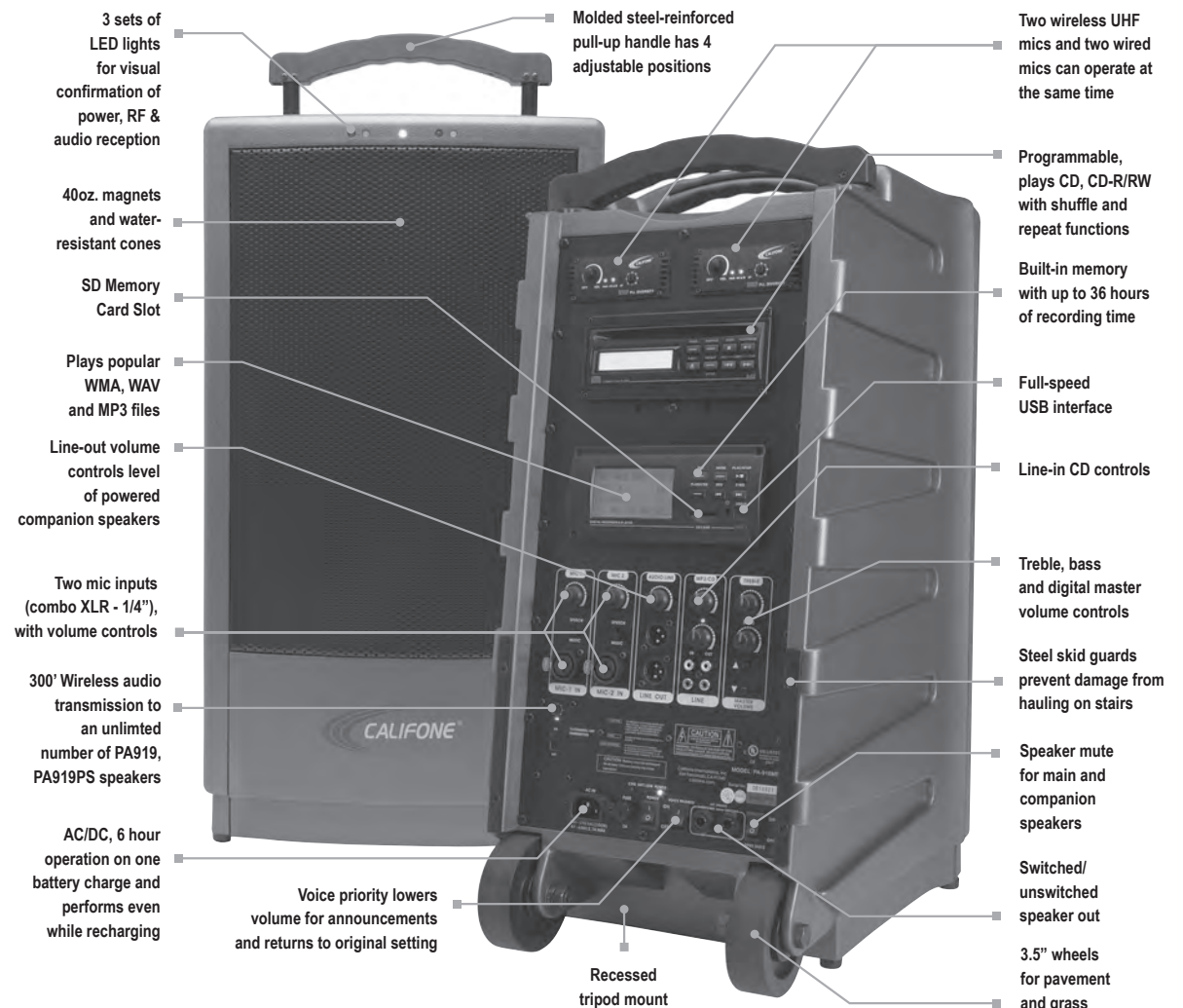

Califone® wireless PA systems deliver professional quality sound in a variety of presentation settings. Since they're simple to set up and operate, you won't need an audio expert. Whether it's a large meeting of parents, an all-school spirit rally or a guest lecturer transmitting wireless audio from a laptop, you'll have clear audio so everyone can listen and participate!



Operation

Battery

Charge the battery for at least 10 hours before the first use of the PA919SD, PA919, or the PA919PS. Simply plug the power cord into an AC outlet and charging begins automatically. The charging indicator will flash until fully charged, then it will stay green. The unit can be used while it is plugged in for charging.

There are two indicators above the main power switch. When the unit is turned on, the one on the left will light "red" when the battery has a low charge. The one on the right will glow "green" if the battery is fully charged or if operating on A/C power.

It is recommended that the battery be recharged after several hours of usage, rather than stored with a low battery. This will prolong battery life. Storing more than 30 days without recharging will deteriorate the battery.

Digital Master Volume Control

When the main power switch is turned on, the Digital Master Volume Control is at the lowest level to prevent accidental damage to the amplifier or internal speakers. The volume can be controlled in two ways; using the "Up"/"Down" buttons on the mixer panel or using the RC-300 infrared remote control. The remote sensor must be used in front of the speaker as the sensor is behind the speaker grille.

Recommended Set-up Procedure

Ideally the master volume should be at maximum volume before the wireless receiver and microphone volumes are adjusted to the desired loudness. Since there are always at least two (2) volume controls to contend with, it is suggested that prior to turning the power on the UHF receiver volume controls be set at "10 o'clock". Also set the microphone volume controls at "10 o'clock". Turn on the main power switch and use either a wireless microphone or cabled microphone to adjust the master volume.

Digital Audio Player/Recorder & CD Player

The main power switch does not control the Digital Audio Player/Recorder and CD player. A separate power switch is combined with the MP3/CD volume control to limit battery drain when the Digital Audio Player/Recorder or CD are not being used.

Wired Microphones

There are two (2) independent combination XLR/1/4" jacks for using microphones with cables. Each jack has a volume control which effects the loudness of both wired and wireless microphones. Also each has a "Voice/Music" switch. On "music" program the sound is full fidelity, while on "voice" the sound is tailored to give maximum projection while limiting battery drain.

Operation continued

Line In

Insert both RCA plugs into the RCA jacks when using a stereo input. The left and right channels are combined so no program material is lost. If the source is monaural, either RCA jack can be used. The Line In volume control is used to increase or decrease the level of the input signal.

Line Out

The two RCA jacks are used to connect to the input of another piece of equipment such as a tape recorder, mixer or another amplified speaker. The outputs are monaural and volume level will depend on the volume of the source. For example, the tape or CD player level is controlled by the tape/CD volume control. Line out is independent of the Master Volume Control.

Tone Controls

The separate base and treble controls provide a wide range of adjustment for increasing or decreasing either the bass or treble from "flat" frequency response. The center or "12 o'clock" position is flat.

Speaker Mute Switch

Engaging this switch will cut off the sound of all speakers, internal and external, except as explained in the section under "PA919PS operation".

Voice Priority

This feature is used for voice override of the music program when using a microphone. The "ducking" circuit attenuates the music when a person speaks into the microphone. After a 3 second delay in the speech, the music returns to the previous level.





Wireless Operation

Wireless UHF Receivers

Wireless receiver "A" is preset at the factory for channel 4 and receiver "B" is set on channel 6. There are three (3) LEDs on the receiver; power (green), RF reception (red) and Audio reception (amber).

There are also LEDs on the front of the speaker above the grille making it easy to see if the microphone and receiver are working properly. A red LED indicates RF (radio frequency) from the mic, while an amber LED indicates audio.

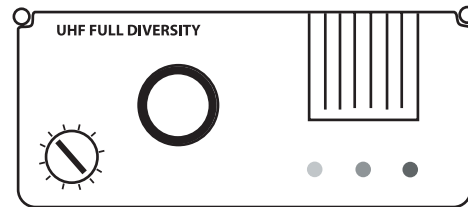

NOTE: There are two wireless 900MHz mic receivers on the PA919SD and PA919 (and 1 on the PA919PS). These frequencies are not compatible with any PA916 series PAs, M-316 or Q-316 microphones.

Wireless Transmitter

The PowerPro PA919SD incorporates a 16 channel UHF transmitter with its own power switch for wireless transmission to another PA919 or the Powered Companion Speaker PA919PS. The transmitter is preset at the factory to channel 13. It is recommended that the user not randomly change this setting. If using the transmitter function change wireless receiver "A" from channel 1 to any other channel except channel 13 to prevent the transmitter from blocking the receiver.

Microphone Lockout

Two wireless microphones can be used at the same time, but separate channels (frequencies) must be used. For instance, if using receiver "A" on channel 4, two microphone beltpack transmitters cannot be used at the same time. The first transmitter turned on will dominate and lock out the other. The second microphone should be used with receiver "B" on a different frequency which will allow two persons to talk at the same time.

Turn the transmitter power switch to OFF when not being used to minimize battery drain.

Feedback

Feedback is a shrill screeching sound produced by the speaker system when a microphone is being used too close to the front of the speaker. The microphone picks up the sound of the speaker system and it becomes reamplified. It is a self-sustaining loop which can damage the system if allowed to continue, not to mention the annoyance caused to persons nearby. Always stand 4 to 6 feet from the speaker to minimize the opportunity for feedback from the speaker system.

900 MHz Microphone & Beltpack Transmitter

Q319 Wireless Microphone



16-Channel UHF Transmitter Selector Buttons

M319 Wireless Belt Pack Transmitter



The M319 is used with these 5 microphones

The M319 and Q319 are designed to work with the PA919 series PAs. They are not compatible with the PA916 series PAs, M-316 or Q-316.



OE-316
Over Ear Mic



NM-316
Neck Mic



LM-316
Lapel Mic



CM-316
Collar Mic



HBM-316
Headset Mic



Digital Audio Player/Recorder

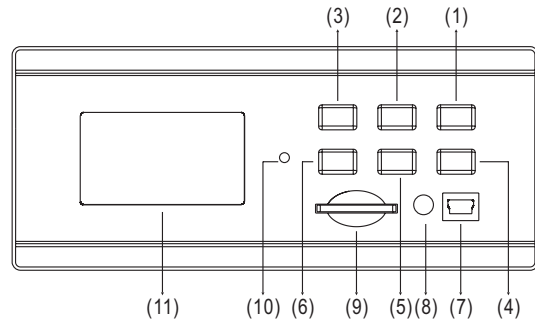

MP3 Section; Component Descriptions

- (1) Play/ Pause / Select
- (2) Menu
- (3) Record
- (4) Skip Next / Fast forward / Next selection
- (5) Skip Previous / Rewind / Previous selection
- (6) Memory Selector (FLASH/SD)
- (7) USB Port
- (8) Headphone Output
- (9) SD card slot
- (10) System Reset
- (11) LCD Display

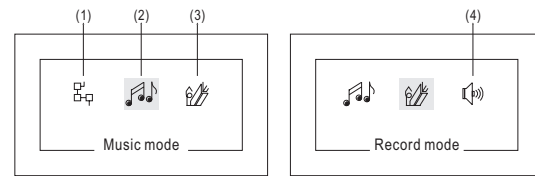

Main Menu Display:

- (1) System Settings: Adjust LCD Contrast, Repeat Mode, Record Type, etc.
- (2) Mode : Music Mode: Select to be able to view and play all mp3 and wma files
- (3) Mode : Record Mode: Select to get into recording mode and begin recording immediately
- (4) Mode : Voice Mode: Select to view all recorded audio files and play them back

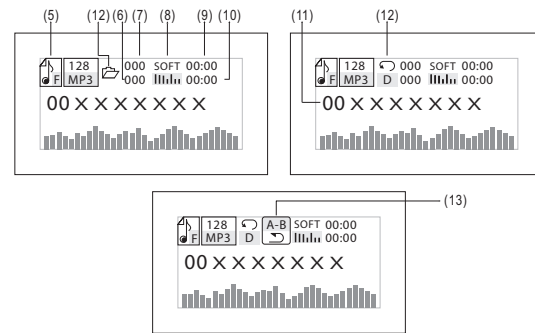

Music/Voice/Record Mode Display:

- (5) Current Selected Memory (F=Flash C=SD Card)
- (6) Total Song Count: Total number of songs on the currently selected memory
- (7) Current Song Number: The number of the song currently selected/playing
- (8) Equalizer Mode : NOR : ROCK : POP : CLAS : SOFT : JAZZ : DBB
- (9) Current play time: Elapsed play time within the current song
- (10) Total play time: Total amount of time for all songs on the currently selected memory
- (11) Artist, Album, and Song name / File name
- (12) Repeat Mode : Repeat One : Random : Normal : Repeat folder : Folder : Repeat All : Intro
- (13) A-B Repeat Mode : Repeat A-B selected section

Digital Audio Player/Recorder

MP3 - Operation Guide

NOTE: Firmware updates and the most up to date user manual for the DigitalAudio Player/Recorder module can be downloaded from the Califone website.

Basic Menu/Button Operation

The menu for the digital audio player/recorder section is operated using the following buttons:

- "RECORD": Immediately enters into Recording Mode and starts recording audio on the currently selected memory.
- "FLASH/SD": Switch the current memory between the internal (Flash) memory and the SD card. If no SD card is plugged into the unit, "card is pulled" will be displayed.
- "SKIP FWD": Moves the active selection to the right
- "SKIP REV": Moves the active selection to the left
- "PLAY / PAUSE / SELECT": Selects / Accepts the currently selected item or setting
- "MENU": "Short" press to access the local menu system. "Long" press to get into the main menu system. Within the local menu system, use this to exit out of the menu

Please note that a "short" press means pressing the button less than about 2 seconds. A "long" press means pressing the button longer than about 2 seconds

Main Menu Operation

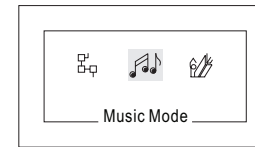

After turning on the power, the main menu will show the icons for "Setting Mode," "Music Mode," "Record Mode," and "Voice Mode". Navigate to the desired function using the forward and reverse skip buttons ("FWD" and "REV"). To enter the desired mode, short press the "PLAY / PAUSE" key.

Music Mode

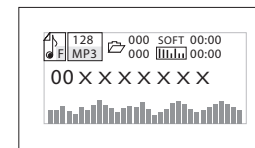

Quick Start: Once in Music Mode, short press "PLAY / PAUSE" once to start playing the selected track.

Music Mode (While music is playing):

The following instructions apply to while music is playing.

1. Short press "MENU" once to enter the local menu. The local menu includes the following icons:

Digital Audio Player/Recorder

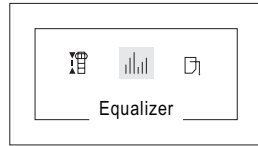

Next/ Prev	Fast Forward/ Backward	Tempo rate	Equalizer	Exit

Next/ Prev

1. Short press "REV" once: last song; short press "FWD" once: next song.
2. Long press "REV" to decrease the digital audio player volume. Long press "FWD" to increase the digital audio player volume. Of course volume can also be adjusted with the MP3/CD volume control on the rear panel of the PA919SD.

Fast forward/ Backward

1. Short press "FWD" once to fast forward the track. Press "FWD" again to resume play from that point in the track.
2. Short press "REV" once to rewind the track. Press "REV" again to resume play from that point in the track.
3. Long press "FWD" and "REV" adjusts the volume as described above.
4. You can also skip to the next or previous tracks within this mode. Simply stop the playback by pressing "PLAY / PAUSE" And then use the "FWD" and "REV" buttons to skip to the previous or next track. Press "PLAY / PAUSE" to play the selected track.

Tempo Rate

Is particularly useful when learning music or dance.

1. Short press "REV" to slow down the tempo or speed. Short press "MENU" once to confirm the setting. Likewise, short press "FWD" once to make the tempo (speed) of the track faster. Continue to press "FWD" to speed up further.
2. Long press "FWD" and "REV" adjusts the volume as described above.
3. Note: 0 is the normal speed, 8 is the fastest, and -8 is the slowest.
4. Note: The Tempo (speed) control function can only be used on tracks saved in the internal (Flash) memory. Also, the function only works using mp3 files. The function does not work with tracks saved in SD card or recordings made on the digital audio player/recorder.

Equalizer

1. Short press "FWD" once or short press "REV" once to enter Equalizer mode. Use the FWD and REV buttons to navigate to the desired setting. Once selected, short press "PLAY / PAUSE" to confirm.
2. The following Equalizer presets are available:

Music Mode Continued

2. Short press "REV" and "FWD" to select items from menu. Short press "PLAY / PAUSE" once to confirm.
3. The REV and FWD buttons will now function differently depending on your selection. Below we will describe the different operations of these keys based on each menu selection.

Digital Audio Player/Recorder

Equalizer Continued

Natural	Rock	Pop	Classic	Soft	Jazz	Bass

3. You can also skip to the next or previous tracks within this mode. Simply stop the playback by pressing "PLAY / PAUSE" And then use the "FWD" and "REV" buttons to skip to the previous or next track. Press "PLAY / PAUSE" to play the selected track.

Music Mode (While music is not playing): The following instructions apply to while music is not playing.

1. Short press "MENU" once to enter the local menu.
2. Short press "FWD" or "REV" to select the desired item and then short press "PLAY / PAUSE" once to confirm. Available options include:

Local File

Select this item to show all the files on the internal memory (Flash).

Delete File

Select this item to delete the current file. Short press "FWD" and "REV" to select YES or NO. Once YES/ NO is selected, short press "MENU" once to delete the file.

Delete All

Select this item to delete all files on the currently selected memory. Short press "FWD" and "REV" to choose YES or NO. Once YES/ NO is selected, short press "MENU" once to delete all the files.

"Play list," "Artists," "Album," "Genre," and "Composers"

These items are currently disabled on this version.

Record Mode

1. When record mode is entered, recording starts immediately. Long press "PLAY / PAUSE" to stop recording and save the file. Once saving is complete, the system goes to Voice Mode automatically. After saving is complete you can long press "MENU" to exit record mode and return to the main menu.

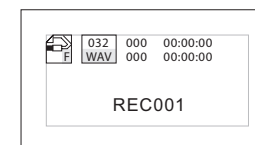

Voice Mode

Quick Start:

1. Short press "FWD" and "REV" to select the recorded file to play back.
2. Short press "PLAY / PAUSE" to start to playback of the recording.

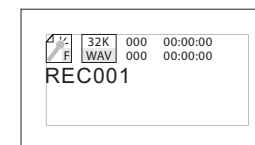

Digital Audio Player/Recorder

Voice Mode *Continued*

Voice Mode (While music/voice is playing): The following instructions apply to while music is playing.

1. Short press "MENU" once to enter the local menu.
2. Short press "FWD" or "REV" to select the desired item and then short press "PLAY / PAUSE" once to confirm.

Available options include:

Next/ Prev

1. Short press "REV" once: last song; short press "FWD" once: next song.
2. Long press "FWD" and "REV" adjusts the volume as described above.

Fast forward/ Backward

1. Short press "FWD" once to fast forward the track. Press "FWD" again to resume play from that point in the track.
2. Short press "REV" once to rewind the track. Press "REV" again to resume play from that point in the track.
3. Long press "FWD" and "REV" adjusts the volume as described above.
4. You can also skip to the next or previous tracks within this mode. Simply stop the playback by pressing "PLAY / PAUSE" And then use the "FWD" and "REV" buttons to skip to the previous or next track. Press "PLAY / PAUSE" to play the selected track.

Voice Mode (While music/voice is not playing): The following instructions apply to while music is not playing.

1. Short press "MENU" once to enter local menu.
2. Short press "FWD" or "REV" to select the desired item and then short press "PLAY / PAUSE" once to confirm.

Available options include:

Local File

Select this item to show all the files on the internal memory (Flash).

Delete File

Select this item to delete the current file. Short press "FWD" and "REV" to select YES or NO. Once YES/ NO is selected, short press "MENU" once to delete the file.

Delete All

Select this item to delete all files on the currently selected memory. Short press "FWD" and "REV" to choose YES or NO. Once YES/ NO is selected, short press "MENU" once to delete all the files.

"Play list," "Artists," "Album," "Genre," and "Composers"

These items are currently disabled on this version.

Digital Audio Player/Recorder

Setting Mode

Within "Setting Mode," short press "REV" and "FWD" to select the desired option.

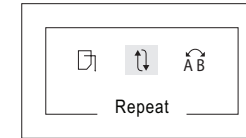

Available options include:

Repeat

1. Short press "REV" and "FWD" to select the desired repeat style.

	Repeat		Replay mode
	Contrast		Memory info
	Firmware version		Record type
	Exit		

Once the desired style is selected, short press "PLAY / PAUSE" once to confirm.

- Repeat One: Repeats only the currently selected song.
- Random: Plays all the songs in random order.
- Normal: Play all songs once in the default order.
- Repeat Folder: Repeat all the songs in the selected folder.
- Folder: Play all the songs in the selected folder once.
- Repeat All: repeat all songs on the currently selected memory.
- Intro: Play the first several seconds of each song, then skip to the next.

2. Repeat folder" and "Folder" settings require an extra step to make them work as desired. Follow this process to select the folder of files to play.

- After selecting either the "Repeat folder" or "Folder" style, enter into "Music Mode" or "Voice Mode".
- Next, short press "MENU".
- In the local menu, select "Local File", to list all the files on the current memory.
- Press "REV" or "FWD" to select the desired folder and press "MENU" to confirm and exit.
- Short press "PLAY / PAUSE" once to start playing.

	Repeat one		Folder
	Repeat folder		Repeat all
	Random		Intro
	Normal		

Repeat setting

1. When the music is playing, short press "RECORD" to set the loop start (A) point.
2. Short press "RECORD" again to set the loop end (B) point.
3. The player will now continuously loop playback between these points in the track.
4. Short press "MENU" to exit the loop function.

Digital Audio Player/Recorder

Setting Mode *Continued*

Contrast adjustment

1. Press "REV" and "FWD" to adjust contrast.
2. Press "PLAY / PAUSE" to confirm the setting or short press "MENU" to cancel.

Memory Info

1. This screen displays the used and unused memory. It can display this information for either the internal (Flash) or SD card.
2. Short press "MENU" to exit.

Firmware version

1. This screen displays the firmware version.

Record type

1. Press "REV" and "FWD" to select the desired recording format. The following formats are available (All are wav file format): 32K BPS (lowest quality, longest record time), 64K BPS, 192K BPS (highest quality, shortest record time).
2. Press "PLAY / PAUSE" to confirm the setting.

USB Connection

A computer can be used to transfer files to or from the digital audio player by connecting to the USB port. Follow this process to connect your computer and transfer files to/from the digital audio player/recorder:

1. Connect a USB cable to the USB ports on both the player and computer.
2. The player will then show the "connecting sign" as seen below:
3. The internal (Flash) memory will now show up as a removable hard drive on you computer.
4. Any SD card plugged into the digital audio player will show up as an additional removable hard drive on you computer.
5. Copy, move, rename, delete files, etc. on these drives as you would on your computer. When you unplug the USB cable the changes will have taken effect.
6. **Notes & Warnings:**
 - a. Warning: When downloading or transmitting files to or from the player, do not disconnect the connector to prevent damage to the player or PC.
 - b. If you are using Windows 98 you may need to install drivers first before the system will recognize the player.
 - c. Before using a new (unformatted) SD card with the digital audio player/recorder, please format the card first.
 - d. If the flash or SD card are not formatted or get corrupted somehow, you may format them by clicking on "My Computer" and then right clicking on the drive and clicking "Format." Note that all data on the drive will be deleted and become unrecoverable. Don't disconnect during the format process or it could completely disable the player so that it will not work. Once formatting is complete, disconnect the USB cable and reconnect it again.
 - e. If the player freezes up for any reason, turn it off for 3 seconds, and then turn the power back on.

Digital Audio Player/Recorder

USB Connection *Continued*

Compatibility (System Requirements)

1. Operation system: WIN98 SE, Windows, ME, 2000, XP
2. USB port.

Features/Specs

- 512MB Internal Flash memory.
- Supports standard bitrate WMA and MP3 format audio files.
- WAV file format recording and playback are supported in Recording and Voice modes. Various bitrates for the wav file recording are supported from low quality to high quality. Low quality recordings allow recording for a longer time.
- Seven equalizer presets are available, including: NOR (normal), ROCK (rock), POP (pop), CLAS (classical), SOFT (soft), JAZZ (jazz), and DBB (bass).
- A-B section looping function.
- Seven playback modes are available, including: Repeat one, Random, Normal, Repeat folder, Folder, Repeat all, and Intro.
- Variable tempo (speed) control is available for mp3 files on the internal (Flash) memory. This feature affects the speed and does not affect the pitch of the recording.
- Adjustable LCD contrast for different environments.
- Equalizer and Repeat mode setting are stored and retained even upon power off.
- USB port for uploading/downloading audio files to and from the digital audio player's internal memory and an SD card.
- Built-in headphone output.

Troubleshooting

- Why won't some files be recognized by the digital audio player? Some MP3 or WMA files won't play.
- This digital audio player supports most standard bitrate and file settings, but due to the large number of compression types, and with new types being added all the time, not all files are recognized. Try to convert any files that don't play into a standard bitrate (128kbps, 196kbps, etc.) mp3 or wma file without special settings in the encoder. Then upload the new file to the digital audio player and try again.
- The track's playback time is not correct. Why?
- VBR format MP3 files may not display the proper track time. Try a fixed bitrate filetype if an accurate track time is needed.

CD Player

CD Player

- 1 **CD SLOT** After the power is turned on the LCD display will read "NO disc" Gently push the CD into the slot and the CD will be recognized and begin playing track #1.
- 2 **LCD DISPLAY**
- 3 **PAUSE/PLAY** When "Play" is pressed, the first track will begin to Play. When Play is pressed again, the mode goes to Pause. When pressed a third time the mode returns to Play.

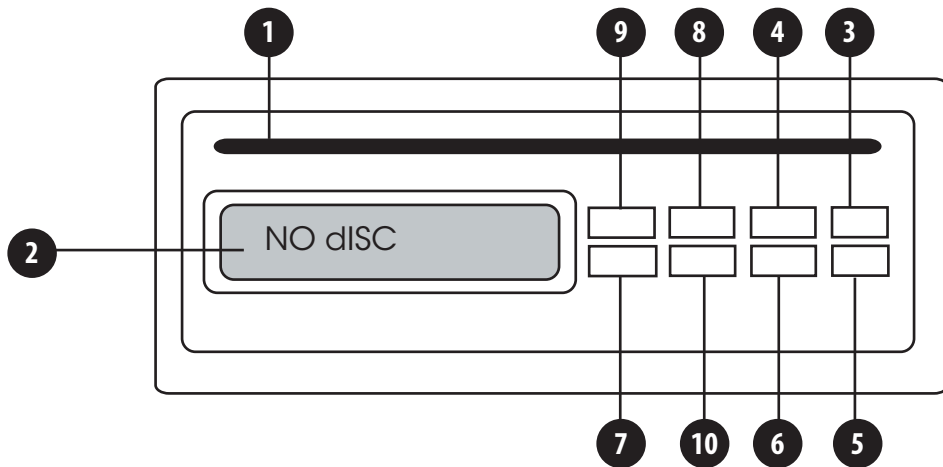

- 4 **STOP** When STOP is pressed from Play or Pause the program is advanced to the end of the last track on the CD.
- 5 **SKIP FORWARD** When FWD is pressed from the Stop mode, the program will advance to the first track. When pressed from Play or Pause mode, the program will advance one track. Continuing to press FWD will advance one track each time.

CD PLAYER Continued

- 6 **SKIP/REVERSE** When REV is pressed from the Stop mode, the program will go back one track and begin playing the last track on the CD. When pressed from Play or Pause mode, the program will go back to the beginning of the track which was already playing. Continuing to press REV will step back one track at a time.
- 7 **REPEAT/ENTER** Pressing Repeat once will continuously replay the selected track. Pressing it twice will replay all tracks continuously. Pressing Repeat a third time will clear the settings.
- 8 **SHUFFLE** Pressing Shuffle from Stop, Play or Pause will result in random selection of tracks and begin playing continuously. Pressing Shuffle again will clear the program.
- 9 **PROGRAM** In Stop mode, press Program and observe "P 1:" on the LCD. Press FWD and see "1:01", press FWD again and see "1:02". Press enter and "2" will appear in the upper right of the LCD. Press FWD three more times and see "1:05". Press Enter and see "5" added to the LCD. Press play and the second track will play, then advance to track 5. After playing all the selected tracks the program advances to the end of the CD. Pressing Play will repeat the program. To clear the program in the Stop mode, just press Program. Individual selections can be cleared while they are playing by pressing Program. This will not affect other selected tracks.
- 10 **EJECT** Pressing Eject from any mode will advance the program to the last track on the CD and eject the CD. "NO dISC" will appear on the LCD.

NOTE: The CD player is capable of playing CD, CD-R and CD-RW discs, however due to the condition of the disc or the original it was copied from some discs may not play.

Powered Companion Speaker PA919PS

The PA919PS works with the PA919 series and M319 and Q319 microphones. It is not compatible with the PA916 series, M-316 and Q-316 microphone.

The Powered Companion PA has the same amplifier, power supply and speaker compliment as the full featured PA919 or PA919SD. It does not have the mixer panel because it can be controlled by the PowerPro PA919SD and PA919.

With the integral 16-channel selectable wireless UHF receiver, it can function as a stand alone PA speaker when using a Q319 Handheld microphone or the M319 Beltpack transmitter with a LM-316, CM-316 or HBM-316 microphone. Although there are 5 LEDs on the front of the PA919PS only 3 lights function on this unit because there is only one receiver. The red LED indicates RF, the amber LED is for audio, and the green LED indicates power On.

Full Wireless Operation

As the transmitter on the PA919 and PA919SD is preset on channel 13, the receiver of the PA919PS is also set on 13. Any audio from the PA919SD can be transmitted to the PA919PS without wiring. There is no limit on the number of PA919PS speakers that can be used with the PA919 within a range of 150 feet.

Audio Line Buss

When linking one or two PA919PS to the PowerPro PA919SD via audio line, the PSC-50 XLR cable is connected to Audio Line Out XLR connector on the PA919SD. The other end is connected to Line In XLR on the Powered Companion Speaker.

The Master Volume Control on the Audio Line panel of the master will adjust the PowerPro PA919SD as well as all the Powered or Passive Companion Speakers, however the loudness needs to be adjusted via the Master Volume Control on the PA919PS as well.

Note: The mute switch on the PA919SD will silence all speakers connected to it by cable. However in the full wireless mode using the transmitter of the PowerPro the mute will have no effect.

Powered Companion Speaker PA919PS

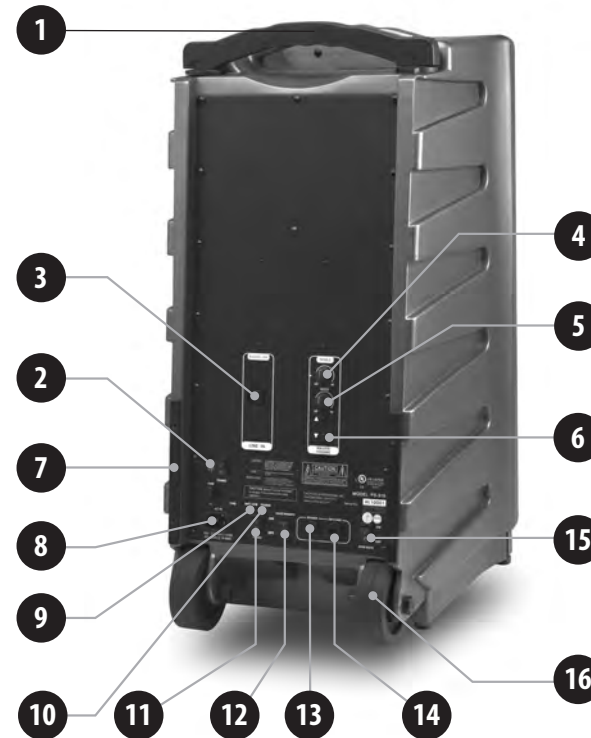

- | | |
|----|---------------------------------------|
| 1 | Telescoping Handle |
| 2 | 16-channel UHF wireless mic receivers |
| 3 | Audio Line Out XLR |
| 4 | Treble Control |
| 5 | Bass Control |
| 6 | Digital Master Volume |
| 7 | Dual Steel Skid Guards |
| 8 | A/C Power Socket |
| 9 | Battery Low/Charge Indicators |
| 10 | Green Power On Indicator |
| 11 | Power On/Off Switch |
| 12 | Voice Priority (Ducking) Switch |
| 13 | 1/4" Phone Jack Speaker Out |
| 14 | 1/4" Phone Jack Speaker Out Switched |
| 15 | Speaker Mute Switch |
| 16 | Integral Wheels |

PA919PS Specifications

Acoustic Speaker Compliment

Woofers	10" Diameter, 40 Oz. Magnet, 2" Dia. Voice Coil, 6 Ohm
Tweeter	Compression Horn Driver, 12 Oz. Magnet, 1" Voice Coil, 8 Ohm
Frequency Response	45Hz to 18KHz
Amplifier	90 Watts RMS @ 5% THD (AC)
Sound Pressure Level	94 dB, 1 Watt @ 1 Meter
Power Sources	100-240 volt AC switchmode power supply and 12 volt 7 AH maintenance-free lead acid batteries (2)

Wireless System

Receiver: One 16-channel selectable UHF diversity wireless receiver 902 ~ 928 MHz (16 channels)
Antennas is hidden internally.

Microphone Transmitters

Handheld wireless microphone or belt-pack transmitters optional.
Belt-pack transmitter used with choice of hands-free headset, collar or lapel microphones.

Audio Line

Line level XLR jacks (2) providing for attaching PA916-SP speakers via cable. Features volume control for remote speaker(s).

Mixer Panel

Mixer panel accepts one wired XLR microphone. Voice music switch adds emphasis in the voice range for longer range projection. Line-In via dual RCA jacks with volume control. Line-Out via dual RCA jacks. Separate Bass and Treble tone controls. Voice priority switch activates "ducking circuit" which overrides music programs when microphone is used. Speaker mute switch mutes the main speaker plus all other speakers connected. Speaker out. Both switched and unswitched 1/4" phone jacks for connecting speakers.

Dimensions	26 H x 12" W x 10" D
Weight	52 lbs.
Compliance	FCC, CE, C-UL

Non-powered Companion Speaker PA916-SP



- 1 Telescoping Handle
- 2 1/4" Phone Jack Speaker In
- 3 Integral Wheels

The PA916-SP is connected to one of two outputs from the PowerPro or Powered Companion Speaker via SP-50 Cable with 1/4" phone plugs.

Connecting to the "Speaker Out" jack will divide the power between the PowerPro PA919SD or PA919PS and PA916-SP. Connecting to the "Switched Out" will disconnect the internal speakers of the PA919SD and deliver all of the power to the PA916-SP.

NOTE:

There are five (5) LEDs on the front of the speaker, however they are disconnected because there is no internal amplifier or wireless receiver in this passive system.

Mechanical Notations

Telescoping Handle and Wheels

These are only intended for pulling the PowerPro over relatively smooth surfaces. Using the handle to lift or carry the unit or pulling up stairs will cause damage not covered by the warranty.

Tripod Mount



A recess is incorporated on the bottom of all PowerPro Speakers for mounting to the TP-50 tripod.





Notes

	CAUTION RISK OF ELECTRIC SHOCK - DO NOT OPEN	
---	--	---

CAUTION: TO REDUCE THE RISK OF ELECTRIC SHOCK, DO NOT REMOVE COVER OR BACK. NO USER SERVICEABLE PARTS INSIDE. REFER SERVICING TO QUALIFIED PERSONNEL.

 <p>The lightning flash with arrowhead within a triangle is intended to tell the user that parts inside the product are a risk of electric shock to persons.</p>	 <p>The exclamation point within a triangle is intended to tell the user that important operating and servicing instructions are in the papers with the appliance.</p>
--	--

 <p>This product is not designed to function normally in strong electromagnetic fields. Consequently, the audio quality may degrade while the product is exposed to strong electromagnetic fields. Normal audio quality operation will be recovered when the strong electromagnetic field is no longer present.</p>	<p>WARNING: TO REDUCE THE RISK OF FIRE OR ELECTRIC SHOCK, SO NOT EXPOSE THIS APPLIANCE TO RAIN OR MOISTURE.</p>	 <p>Ce produit n'est pas conçu pour un fonctionnement dans de forts champs électromagnétiques. Par conséquent, la qualité sonore peut diminuer si ce produit est exposé à un fort champ électromagnétique. La qualité sonore redeviendra normale après affaiblissement du champ électromagnétique.</p>
--	--	--

IMPORTANT SAFETY INSTRUCTIONS

ATTENTION: ALL SAFETY AND OPERATING INSTRUCTIONS SHOULD BE READ BEFORE OPERATING APPLIANCE. ALL OPERATING AND USE INSTRUCTIONS SHOULD BE FOLLOWED WHEN OPERATING THE APPLIANCE. HEED AND ADHERE TO ALL WARNINGS ON THE APPLIANCE AND IN THE OPERATING INSTRUCTIONS. RETAIN ALL SAFETY AND OPERATING INSTRUCTIONS FOR FUTURE REFERENCE.

WATER & MOISTURE - DO NOT USE THE APPLIANCE NEAR WATER; IE. BATHTUB, WASHBOWL, KITCHEN SINK, LAUNDRY TUB, WET BASEMENT OR SWIMMING POOL.

VENTILATION - DO NOT SITUATE THE APPLIANCE SO THAT ITS LOCATION OR POSITION INTERFERES WITH ITS PROPER VENTILATION. FOR EXAMPLE, THE APPLIANCE SHOULD NOT BE SITUATED ON A BED, SOFA, RUG OR SIMILAR SURFACE THAT MAY BLOCK THE VENTILATION OPENINGS. THE APPLIANCE SHOULD NOT BE PLACED IN A BUILT-IN INSTALLATION, SUCH AS A BOOKCASE OR CABINET, THAT MAY IMPEDE THE FLOW OF AIR THROUGH THE VENTILATION OPENINGS.

HEAT - SITUATE THE APPLIANCE AWAY FROM HEAT SOURCES SUCH AS RADIATORS, HEAT REGISTERS, STOVES OR OTHER APPLIANCES (INCLUDING AMPLIFIERS) THAT PRODUCE HEAT.

POWER SOURCES - CONNECT THE APPLIANCE ONLY TO A POWER SUPPLY TYPE DESCRIBED IN THE OPERATING INSTRUCTIONS OR MARKED ON THE APPLIANCE.

GROUNDING OR POLARIZATION - PRECAUTIONS SHOULD BE TAKEN SO THAT THE GROUNDING OR POLARIZATION MEANS OF THE APPLIANCE ARE NOT DEFEATED.

POWER CORD PROTECTION - POWER SUPPLY CORDS SHOULD BE ROUTED SO THAT THEY ARE NOT LIKELY TO BE WALKED ON OR PINCHED BY ITEMS PLACED UPON OR AGAINST THEM, PAYING PARTICULAR ATTENTION TO CORDS AT PLUGS, CONVENIENCE RECEPTACLES, AND THE POINT WHERE THEY EXIT FROM THE APPLIANCE.

CLEANING - THE APPLIANCE SHOULD BE CLEANED ONLY AS RECOMMENDED BY THE MANUFACTURER.

NON USE PERIODS - UNPLUG THE APPLIANCE POWER CORD FROM THE OUTLET WHEN LEFT UNUSED FOR A LONG PERIOD OF TIME.

OBJECT & LIQUID ENTRY - CARE SHOULD BE TAKEN SO THAT OBJECTS DO NOT FALL AND LIQUIDS ARE NOT SPILLED INTO THE ENCLOSURE THROUGH OPENINGS.

DAMAGE REQUIRING SERVICE - THE APPLIANCE SHOULD BE SERVICED BY QUALIFIED SERVICE PERSONNEL WHEN: (A) THE POWER SUPPLY CORD OR THE PLUG HAS BEEN DAMAGED (B) OBJECTS HAVE FALLEN OR LIQUID HAS BEEN SPILLED INTO THE APPLIANCE (C) THE APPLIANCE HAS BEEN EXPOSED TO RAIN (D) THE APPLIANCE DOES NOT APPEAR TO BE OPERATING NORMALLY OR EXHIBITS A MARKED CHANGE IN PERFORMANCE (E) THE APPLIANCE HAS BEEN DROPPED OR THE ENCLOSURE DAMAGED.

SERVICING - THE USER SHOULD NOT ATTEMPT TO SERVICE THE APPLIANCE BEYOND THAT DESCRIBED IN THE OPERATING INSTRUCTIONS. ALL OTHER SERVICING REFER TO A QUALIFIED SERVICE PERSONNEL.