

SHARP

Important



R-775 / R-785 MICROWAVE OVEN WITH TOP AND BOTTOM GRILL

OPERATION MANUAL WITH COOKBOOK

OPERATION MANUAL

This operation manual contains important information which you should read carefully before using your microwave oven.

IMPORTANT: There may be a serious risk to health if this operation manual is not followed or if the oven is modified so that it operates with the door open.

900 W (IEC 60705)

ENGLISH



Dear Customer,

Congratulations on acquiring your new microwave oven with grill, which from now on will make your kitchen chores considerably easier.

You will be pleasantly surprised by the kinds of things you can do with a microwave. Not only can you use it for rapid defrosting or heating up of food, you can also prepare whole meals.

In our test kitchen our microwave team has gathered together a selection of the most delicious international recipes which are quick and simple to prepare.

Be inspired by the recipes we have included and prepare your own favourite dishes in your microwave oven.

There are so many advantages to having a microwave oven which we are sure you will find exciting:

- Food can be prepared directly in the serving dishes, leaving less to wash up.
- Shorter cooking times and the use of little water and fat ensure that many vitamins, minerals and characteristic flavours are preserved.

We advise you to read the cookery book guide and operating instructions carefully.

You will then easily understand how to use your oven.

Enjoy using your microwave oven and trying out the delicious recipes.

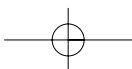
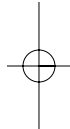
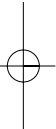



CONTENTS



OVEN AND ACCESSORIES	2
CONTROL PANEL	3
IMPORTANT SAFETY INSTRUCTIONS	4-6
INSTALLATION	6
BEFORE OPERATION	7
SELECTING A LANGUAGE	7
ENERGY SAVE MODE	8
USING THE STOP BUTTON	8
SETTING THE CLOCK	9
MICROWAVE POWER LEVELS	9
MICROWAVE COOKING	10
GRILL COOKING	10-11
HEATING WITHOUT FOOD	11
DUAL COOKING	12
OTHER CONVENIENT FUNCTIONS	13-15
AUTOMATIC OPERATION (EXPRESS PIZZA)	16
EXPRESS PIZZA CHART	16
AUTOMATIC OPERATION (PIZZA/FUN MENUS/AUTO COOK/AUTO DEFROST)	17-18
PIZZA CHART	18
FUN MENU CHART	19
AUTO COOK CHART	19
AUTO DEFROST CHART	20
RECIPES FOR AUTO COOK AC-3	21
CARE AND CLEANING	22
SERVICE CALL CHECK	23
SERVICE ADDRESSES	24-29
SPECIFICATIONS	BACK COVER

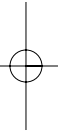
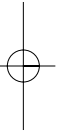

ENGLISH



OVEN AND ACCESSORIES

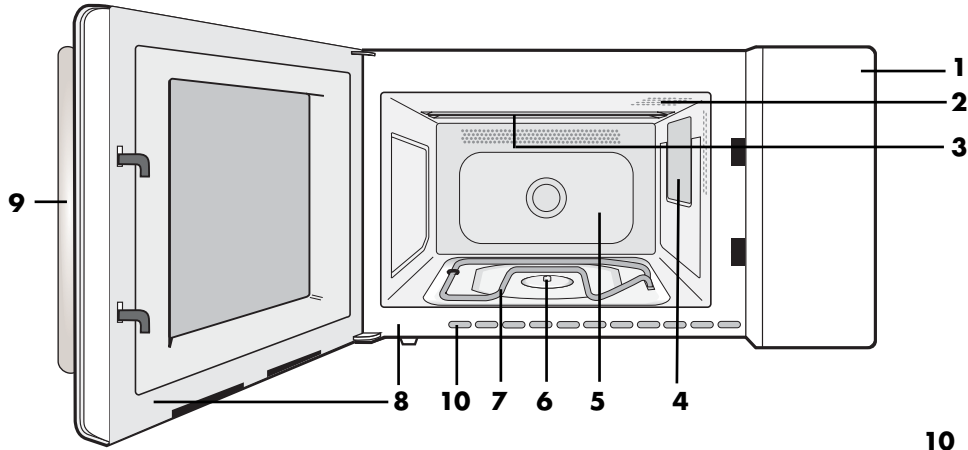

- 1 Control panel
- 2 Oven lamp
- 3 Grill heating element (top grill)
- 4 Waveguide cover
- 5 Oven cavity
- 6 Turntable motor shaft
- 7 Grill heating element (bottom grill)
- 8 Door seals and sealing surfaces
- 9 Door opening handle

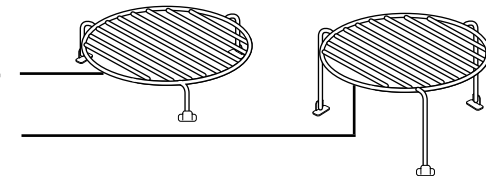
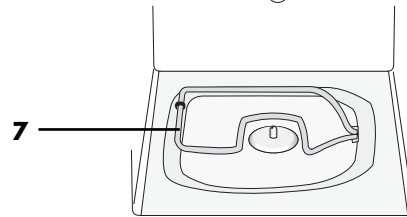
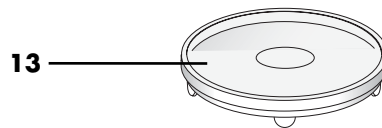
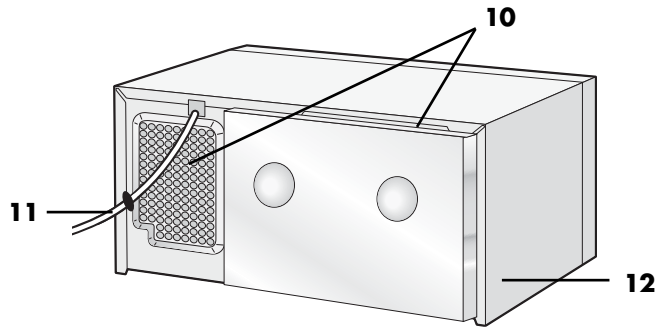

ACCESSORIES:

Check to make sure the following accessories are provided:

- 13 Turntable
- 14 Low Rack
- 15 High Rack

Place the turntable over the turntable motor shaft on the floor of the cavity.

Before first using the turntable and racks, clean with mild soapy water.

Do not cut or scratch the turntable.

WARNING:

The accessories (e.g. turntable) will become very hot during Grill, Dual and Automatic operation (except Auto Defrost) modes. Always use thick oven gloves when removing the food or turntable from the oven to prevent burns.

NOTE:

When you order accessories, please mention the following two items: Part name and model name to your dealer or SHARP authorized service agent.

CONTROL PANEL

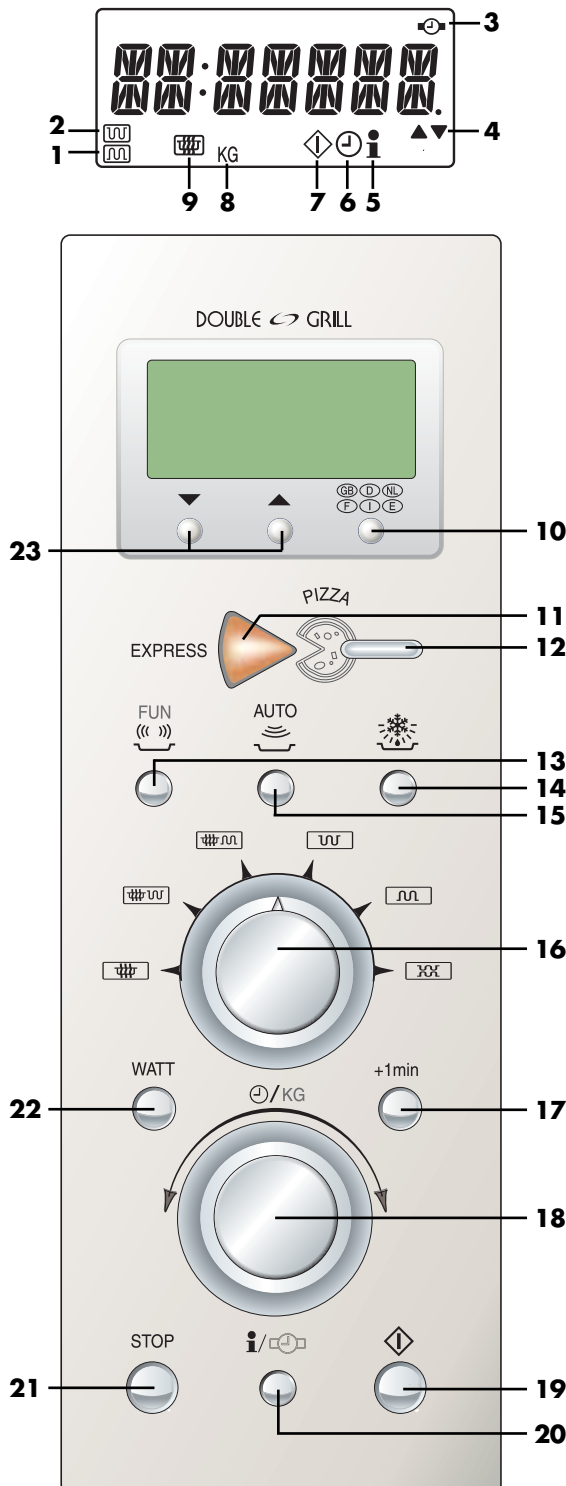

Digital display and indicators:

- 1 **BOTTOM GRILL** indicator
- 2 **TOP GRILL** indicator
- 3 **CLOCK SET** indicator
- 4 **LESS/MORE** indicator
- 5 **INFORMATION** indicator
- 6 **TIMER** indicator
- 7 **COOKING IN PROGRESS** indicator
- 8 **WEIGHT (kg)** indicator
- 9 **MICROWAVE** indicator

Operating buttons:

- 10 **LANGUAGE** button
- 11 **EXPRESS PIZZA** button
- 12 **PIZZA** button
- 13 **FUN MENUS** button
- 14 **AUTO DEFROST** button
- 15 **AUTO COOK** button
- 16 **COOKING MODE** dial

Rotate the dial so that indicator points to appropriate symbol:

for microwave cooking

for microwave cooking with TOP GRILL

for microwave cooking with BOTTOM GRILL

for TOP GRILL

for BOTTOM GRILL

for TOP & BOTTOM GRILLS

- 17 **+ 1 min** button

- 18 **TIME/WEIGHT** dial

Rotate the dial to enter either the cooking/defrosting time or weight of food.

- 19 **START** button

- 20 **INFO/CLOCK** button

- 21 **STOP** button

- 22 **MICROWAVE POWER LEVEL** button

Press to change the microwave power setting.

- 23 **LESS/MORE** buttons



IMPORTANT SAFETY INSTRUCTIONS

IMPORTANT SAFETY INSTRUCTIONS: READ CAREFULLY AND KEEP FOR FUTURE REFERENCE

To avoid the danger of fire

The microwave oven should not be left unattended during operation. Power levels that are too high or cooking times that are too long may overheat foods resulting in a fire.

In cases where the oven is to be installed into kitchen cabinet, the installation frame EBR-4900 licensed by SHARP must be used. This is available from your dealer. Refer to the frame installation instructions or ask your dealer for the proper instruction procedure. Only the use of this frame will guarantee the safety and quality of the product.

The electrical outlet must be readily accessible so that the unit can be unplugged easily in an emergency.

The AC power supply must be 230 V, 50 Hz, with a minimum 16 A distribution line fuse, or a minimum 16 A distribution circuit breaker.

It is recommended that a separate circuit serving only this appliance be provided.

Do not place the oven in areas where heat is generated. For example, close to a conventional oven. Do not install the oven in an area of high humidity or where moisture may collect.

Do not store or use the oven outdoors.

If food being heated begins to smoke, DO NOT OPEN THE DOOR. Turn off and unplug the oven and wait until the food has stopped smoking. Opening the door while food is smoking may cause a fire.

Use only microwave-safe containers and utensils. See Page X.

Do not leave the oven unattended when using disposable plastic, paper or other combustible food containers.

Clean the waveguide cover, the oven cavity and the turntable after use. After cooking fatty foods without a lid, always clean the cavity and especially the grill element thoroughly. These must be dry and free from grease. Built-up grease may overheat and begin to smoke or catch fire.

Do not place flammable materials near the oven or ventilation openings. Do not block the ventilation openings.

Remove all metallic seals, wire twists, etc., from food and food packages. Arcing on metallic surfaces may cause a fire.

Do not use the microwave oven to heat oil for deep frying. The temperature cannot be controlled and the oil may catch fire.

To make popcorn, use only special microwave popcorn makers.

Do not store food or any other items inside the oven. Check the settings after you start the oven to ensure the oven is operating as desired.

See the corresponding hints in the cookery book section.

To avoid the possibility of injury

WARNING:

Do not operate the oven if it is damaged or malfunctioning. Check the following before use:

- The door; make sure the door closes properly and ensure it is not misaligned or warped.
- The hinges and safety door latches; check to make sure they are not broken or loose.
- The door seals and sealing surfaces; ensure that they have not been damaged.
- Inside the oven cavity or on the door; make sure there are no dents.
- The power supply cord and plug; ensure that they are not damaged.

Never adjust, repair or modify the oven yourself. It is hazardous for anyone other than a competent person to carry out any service or repair operation which involves the removal of a cover which gives protection against exposure to microwave energy.

Do not operate the oven with the door open or alter the door safety latches in any way.

Do not operate the oven if there is an object between the door seals and sealing surfaces.

Do not allow grease or dirt to build up on the door seals and adjacent parts. Follow instructions for "Care and Cleaning", Page 22.

Individuals with PACEMAKERS should check with their doctor or the manufacturer of the pacemaker for precautions regarding microwave ovens.

To avoid the possibility of electric shock

Under no circumstances should you remove the outer cabinet.

Never spill or insert any objects into the door lock openings or ventilation openings. In the event of a spill, turn off and unplug the oven immediately, and call an authorised SHARP service agent.

Do not immerse the power supply cord or plug in water or any other liquid.

Do not let the power supply cord hang over the edge of a table or work surface.

IMPORTANT SAFETY INSTRUCTIONS



Keep the power supply cord away from heated surfaces, including the rear of the oven.

Do not attempt to replace the oven lamp yourself or allow anyone who is not an electrician authorised by SHARP to do so. If the oven lamp fails, please consult your dealer or an authorised SHARP service agent.

If the power supply cord of this appliance is damaged, it must be replaced by an authorised SHARP service agent.

To avoid the possibility of explosion and sudden boiling:

WARNING: Liquids and other foods must not be heated in sealed containers since they are liable to explode.

Never use sealed containers. Remove seals and lids before use. Sealed containers can explode due to a build up of pressure even after the oven has been turned off.

Take care when microwaving liquids. Use a wide-mouthed container to allow bubbles to escape.

Never heat liquids in narrow necked containers such as baby bottles, as this may result in the contents erupting from the container when heated and cause burns.

To prevent sudden eruption of boiling liquid and possible scalding:

1. Stir liquid prior to heating/reheating.
2. It is advisable to insert a glass rod or similar utensil into the liquid whilst reheating.
3. Let liquid stand for at least 20 seconds in the oven at the end of cooking time to prevent delayed eruptive boiling.

Do not cook eggs in their shells, and whole hard boiled eggs should not be heated in microwave ovens since they may explode even after microwave cooking has ended. To cook or reheat eggs which have not been scrambled or mixed, pierce the yolks and the whites, or the eggs may explode. Shell and slice hard boiled eggs before reheating them in the microwave oven.

Pierce the skin of such foods as potatoes, sausages and fruit before cooking, or they may explode.

To avoid the possibility of burns

Use pot holders or oven gloves when removing food from the oven to prevent burns.

Always open containers, popcorn makers, oven cooking bags, etc., away from the face and hands to avoid steam burns.

To avoid burns, always test food temperature and stir before serving and pay special attention to the temperature of food and drink given to babies, children or the elderly.

Temperature of the container is not a true indication of the temperature of the food or drink; always check the food temperature.

Always stand back from the oven door when opening it, to avoid burns from escaping steam and heat.

Slice stuffed baked foods after heating to release steam and avoid burns.

Keep children away from the door to prevent them burning themselves.

Do not touch the oven door, outer cabinet, rear cabinet, oven cavity, ventilation openings, bottom grill, accessories and dishes during **GRILL, DUAL** and **AUTOMATIC** operation (except **AUTO DEFROST**) as they will become hot. Before cleaning make sure they are not hot.

To avoid misuse by children

WARNING: Only allow children to use the oven without supervision when adequate instructions have been given so that the child is able to use the oven in a safe way and understands the hazards of improper use.

Do not lean or swing on the oven door. Do not play with the oven or use it as a toy.

Children should be taught all important safety instructions: use of pot holders, careful removal of food coverings; paying special attention to packaging (e.g. self-heating materials) designed to make food crisp, as they may be extra hot.

Other warnings

Never modify the oven in any way.

Do not move the oven while it is in operation.

This oven is for home food preparation only and may only be used for cooking food. It is not suitable for commercial or laboratory use.

To promote trouble-free use of your oven and avoid damage.

Never operate the oven when it is empty except where recommended in the operation manual, see Page 11. Doing so may damage the oven.

When using a browning dish or self-heating material, always place a heat-resistant insulator such as a porcelain plate under it to prevent damage to the turntable due to heat stress.



IMPORTANT SAFETY INSTRUCTIONS

The preheating time specified in the dish's instructions must not be exceeded.

Do not use metal utensils, which reflect microwaves and may cause electrical arcing. Do not put cans in the oven.

Use only the turntable designed for this oven.

Do not place anything on the outer cabinet during operation.

Do not use plastic containers for microwaving if the oven is still hot from using the **GRILL, DUAL** and **AUTOMATIC** operation (except **AUTO DEFROST**), because they may melt. Plastic containers must not be used during above modes unless the container manufacturer says they are suitable.

NOTE:

If you are unsure how to connect your oven, please consult an authorised, qualified electrician.

Neither the manufacturer nor the dealer can accept any liability for damage to the oven or personal injury resulting from failure to observe the correct electrical connection procedure.

Water vapour or drops may occasionally form on the oven walls or around the door seals and sealing surfaces. This is a normal occurrence and is not an indication of microwave leakage or a malfunction.



INSTALLATION

1. Remove all packing materials from the inside of the oven cavity. Discard the loose polythene sheet from between the door and cavity. Remove the feature sticker, if attached, from the outside of the door.

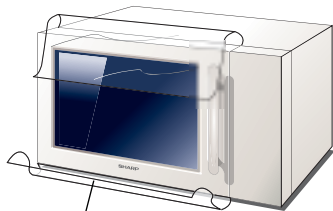

✓ Remove this film

2. Check the oven carefully for any signs of damage.
3. Place the oven on a flat, level surface strong enough to support the oven's weight plus the heaviest item likely to be cooked.

4. The oven door may become hot during cooking. Place or mount the oven so that the bottom of the oven is 85 cm or more above the floor. Keep children away from the door to prevent them burning themselves.

5. **Do not allow the power supply cord to run over any hot or sharp surfaces, such as the hot air vent area at the top rear of the oven.**

6. Ensure there is a minimum of free space above the oven of 19 cm.

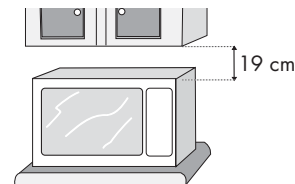

7. Securely connect the plug of the oven to a standard earthed (grounded) household electrical outlet.

BEFORE OPERATION



Your oven comes pre-set for Energy Save Mode so when you first plug it in nothing will appear on the digital display.

To operate the oven in Energy Save Mode:

1. Plug in the oven. Nothing will appear on the display at this time.
2. Open the door. The oven display will show "SELECT LANGUAGE" in 6 languages.
3. Close the door.
4. Select a language (see below).
5. Heat the oven without food (See page 11).

NOTE:

You can change to Clock Set Mode if you prefer, see page 9 of the operation manual. If you decide to set the clock, Energy Save Mode does not work.

COOKING HINTS:

Your oven has an 'Information Display System' which allows you to access step by step instructions for each of the ovens features/buttons. Instructions will appear in the digital display each time you press a button to inform you of the next operation step.

In Energy Save Mode, if you do not operate the oven for 3 minutes or more (i.e. closing the door, pressing the **STOP** key, or at the end of cooking), you will not be able to operate the oven until you open and close the oven door.

SELECTING A LANGUAGE



Press LANGUAGE button	LANGUAGE
once	ENGLISH
twice	DEUTSCH
3 times	NEDERLANDS
4 times	FRANCAIS
5 times	ITALIAN
6 times	ESPANOL

Your oven initially has English selected as the language. To change to a language of your choice, scroll through the options available by pressing the **LANGUAGE** button as shown in the table opposite. Then press the **START**  button.

Example:

Suppose you want to select **Italian**.

1. Choose the desired language

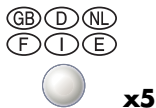

2. Start the setting.

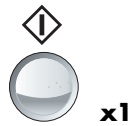

Check the display:

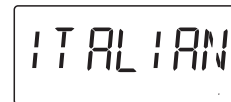

NOTE: The selected language will be memorised, even if the electrical power supply is interrupted.



ENERGY SAVE MODE

Your oven has two operating modes, Energy Save Mode and Clock Set Mode. The difference between them is that when you are not using the oven, in Energy save Mode nothing will appear on the digital display and in Clock Set Mode the time will be shown.

In Energy Save Mode, if you do not operate the oven for 3 minutes or more (i.e. closing the door, pressing the **STOP** key, or at the end of cooking), you will not be able to operate the oven. To restore power on, open the door.

If you set the clock, energy save mode will be cancelled.

To start energy save mode manually, follow the instructions below.

Example:

To start the energy save mode, (the current time is 23:35):

1. Make sure the correct time appears on the display.
2. Press the **INFO/CLOCK** button twice.
3. Adjust the display to 0 by rotating the **TIME/WEIGHT** dial.
4. Press **START** button. The power will be off and the display will show nothing.

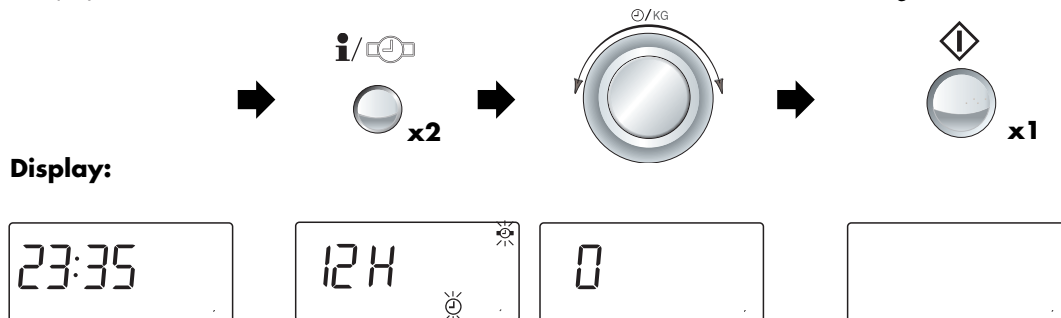

USING THE STOP BUTTON

STOP



Use the **STOP** button to:

1. Erase a mistake during programming.
2. Stop the oven temporarily during cooking.
3. Cancel a programme during cooking, press the **STOP** button twice.

SETTING THE CLOCK



There are two setting modes: 12 hour clock and 24 hour clock.

1. To set the 12 hour clock, press the **INFO/CLOCK** button twice, as shown:

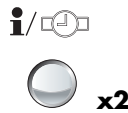

2. To set the 24 hour clock, press the **INFO/CLOCK** button 3 times, as shown:



Example:

To set the 24 hour clock to 23:35:

1. Choose the 24 hour clock by pressing the **INFO/CLOCK** button 3 times.
2. Set the hours. Rotate the **TIME/WEIGHT** dial clockwise until the correct hour is displayed.
3. Change from hours to minutes by pressing the **INFO/CLOCK** button once.

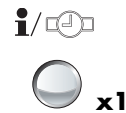
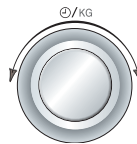
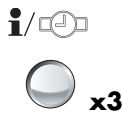

4. Set the minutes.

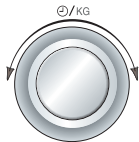

5. Start the clock.

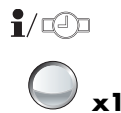

- Check the display.

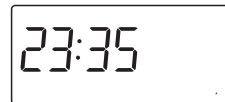

NOTES:

1. You can rotate the **TIME/WEIGHT** dial clockwise or counter clockwise.
2. Press the **STOP** button if you make a mistake during programming.
3. If the oven is in cooking mode and you wish to know the time of day, touch the **INFO/CLOCK** button. As long as your finger is touching the button, the time of day will be displayed.
4. If the electrical power supply to your microwave oven is interrupted, plug in the oven again, then open and close the door. The display will show: "ENERGY SAVE MODE TO GO OUT OF ENERGY SAVE MODE SET CLOCK". If this occurs during cooking, the programme will be erased. The time of day will also be erased.
5. When you want to reset the time of day, follow the above example again.
6. If you do not set the clock, press the **STOP** button once. ".0" will appear on the display. When the operation of the oven is finished, ".0" will reappear on the display instead of the time of day.
7. If you set the clock, energy save mode does not work.

MICROWAVE POWER LEVELS



Your oven has 5 power levels. To choose the power level, follow the advice given in the recipe section.



900 WATT = 100 % output

630 WATT = 70 % output

450 WATT = 50 % output

270 WATT = 30 % output

90 WATT = 10 % output

- To select Microwaving, rotate the **COOKING MODE** dial to the  MICROWAVE setting.
- Select the desired microwave power setting by pressing the **MICROWAVE POWER LEVEL** button.
- If the **MICROWAVE POWER LEVEL** button is pressed once,  (100 %) will be displayed. If you miss your desired level, continue pressing the **MICROWAVE POWER LEVEL** button until you reach the level again.
- **If the level is not selected, the level 900 W (100 %) is automatically set.**



MICROWAVE COOKING

Your oven can be programmed for up to 90 minutes. (90.00). The input unit of cooking (defrosting) time varies from 10 seconds to five minutes. It depends on the total length of the cooking (defrosting) time as shown on the table opposite:

Cooking Time:	Increasing unit:
0-5 minutes	10 seconds
5-10 seconds	30 seconds
10-30 minutes	1 minute
30-90 minutes	5 minutes

Example:

Suppose you want to heat soup for 2 minutes and 30 seconds on 630 W microwave power.

1. Rotate the **COOKING MODE** dial to the MICROWAVE setting.
2. Enter desired cooking time by rotating the **TIME/WEIGHT** dial clockwise.
3. Press the **MICROWAVE POWER LEVEL** button twice for 630 W microwave power.
4. Press the **START** button once to start cooking.

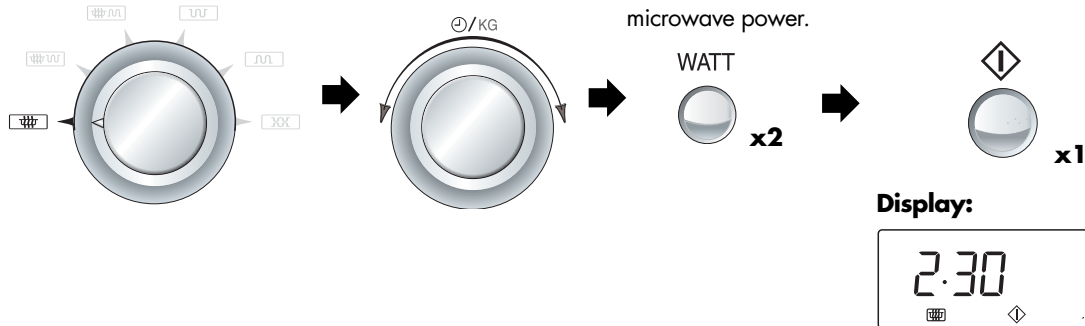

NOTES:

1. When the door is opened during the cooking process, the cooking time on the digital display stops automatically. The cooking time starts to count down again when the door is closed and the **START** button is pressed.
2. If you wish to know the power level during cooking, press the **MICROWAVE POWER LEVEL** button. As long as your finger is pressing the **MICROWAVE POWER LEVEL** button, the power level will be displayed.
3. You can rotate the **TIME/WEIGHT** dial clockwise or counter-clockwise. If you rotate the dial counter-clockwise, the cooking time will decrease from 90 minutes by degrees.



GRILL COOKING

Your oven has 2 grill heating elements, and a combination of 3 grill cooking modes. Select the desired grill mode by rotating the **COOKING MODE** dial to the desired setting.

COOKING MODE DIAL	GRILL HEATING ELEMENT IN USE	DISPLAY
	Top and Bottom Grill together	TOP AND BOTTOM
	Top Grill	TOP GRILL
	Bottom Grill	BOTTOM GRILL

GRILL COOKING



Example:

Suppose you want to cook cheese on toast for 5 minutes using the top grill only: (Place toast on the high rack.)

1. Rotate the **COOKING MODE** dial to the **TOP GRILL** setting.
2. Enter the desired cooking time by rotating the **TIME/WEIGHT** dial clockwise.
3. Press the **START** button to start cooking.

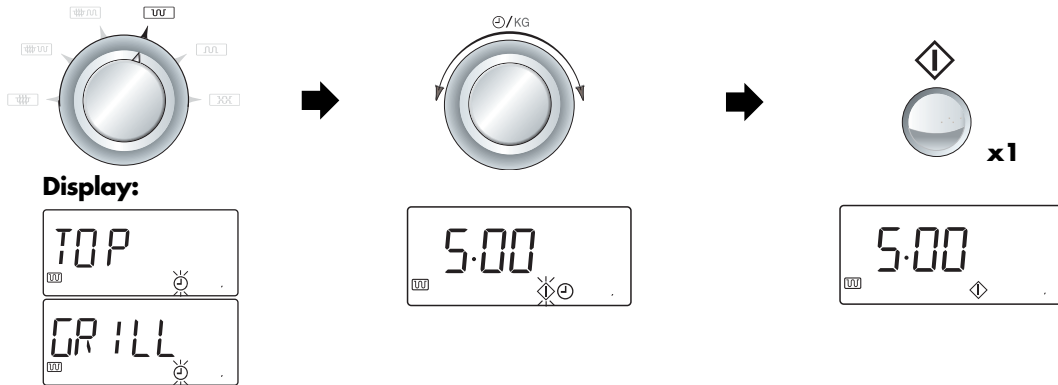

1. The high or low racks are recommended when grilling.
2. You may detect smoke or a burning smell when using the grill for the first time, this is normal and not a sign that the oven is out of order. (Please see heating without food below.)
3. After cooking using TOP GRILL and BOTTOM GRILL the display may show 'NOW COOLING'.

WARNING: The oven cavity, door, outer cabinet, turntable, racks, dishes and especially the bottom grill will become very hot, always use thick oven gloves when removing the food or turntable from the oven to prevent burns.

HEATING WITHOUT FOOD



You may detect smoke or a burning smell when using the grill(s) or dual grill for the first time. This is normal and not a sign that the oven is out of order.

To avoid this problem, when first using the oven, operate both top and bottom grills without food for 20 minutes.

IMPORTANT: During grill operation, to allow smoke or smells to disperse open a window or switch the kitchen ventilation on. Make sure there is no food in the oven.

1. Rotate the **COOKING MODE** dial to the **TOP & BOTTOM GRILL** setting.
2. Enter the required heating time. (20 min.)
3. Start cooking by pressing the **START** button.
4. The oven will count down. When the oven has finished cooking, open the door to cool the oven cavity.

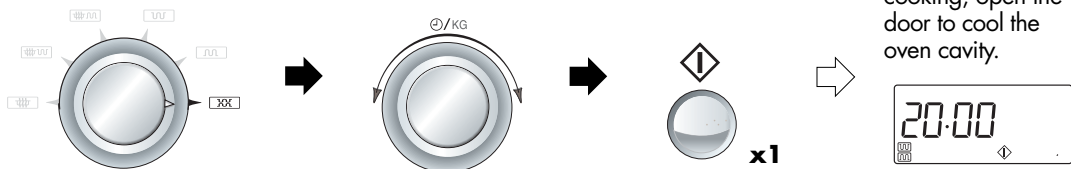

WARNING: The oven door, outer cabinet & oven cavity will become hot. Take care to avoid burns when cooling the oven down after operation.



DUAL COOKING

Your oven has 2 **DUAL** cooking modes to combine the Microwave with the Grill(s). To select the **DUAL** cooking mode, rotate the **COOKING MODE** dial to the desired setting. Generally, dual cooking time shortens the total cooking time.

Setting	COOKING MODE dial	Initial Microwave power	Grill heating element	Display
DUAL 1 		270 W	Top grill	
DUAL 2 		270 W	Bottom grill	

* If you want to adjust the microwave power, press the **MICROWAVE POWER LEVEL** button. You can select up to 900 W power.

Example:

Suppose you want to cook for 20 minutes on DUAL 1, combining 90 W (10 %) with the TOP GRILL:

1. Rotate the **COOKING MODE** dial to the setting, combining microwaving with the TOP GRILL.
2. Enter the desired cooking time by rotating the **TIME/WEIGHT** dial clockwise.
3. Press the **MICROWAVE POWER LEVEL** button twice for 90 W microwave power.
4. Press the **START** button to start cooking.

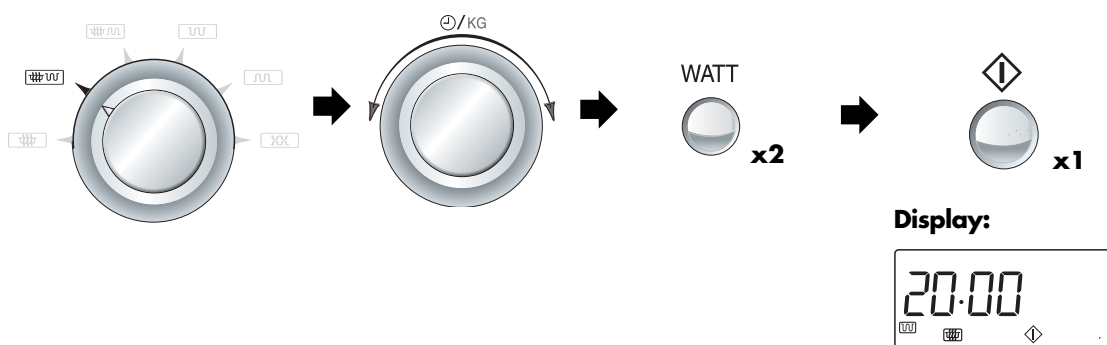

NOTE: After cooking, the display may show "NOW COOLING".

WARNING: The oven cavity, door, outer cabinet, turntable, racks, dishes and especially the bottom grill will become very hot, always use thick oven gloves when removing the food or turntable from the oven to prevent burns.

OTHER CONVENIENT FUNCTIONS



1. LESS / MORE button.

The **LESS** (▼) and **MORE** (▲) buttons allow you to easily decrease or increase programmed setting times, (for a less well or more well cooked result), used in automatic operations or cooking time while in operation.

a) Changing the pre-programmed time setting.

Example:

Suppose you want to cook 0.4 kg Grill Skewers using the **AUTO COOK** button and **MORE** (▲) button.

1. Choose the desired result (well cooked) by pressing the **MORE** (▲) button once.
2. Select **AUTO COOK** (Grill Skewers) by pressing the **AUTO COOK** button once.
3. Enter the amount by rotating the **TIME/WEIGHT** dial clockwise.
4. Press the **START** button to start cooking.

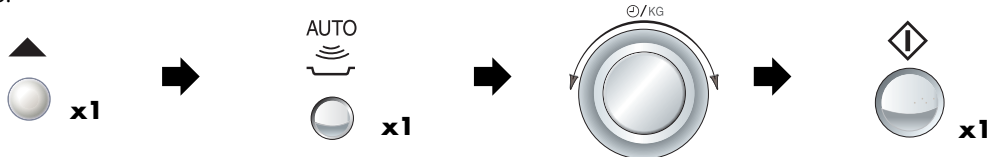

Display:

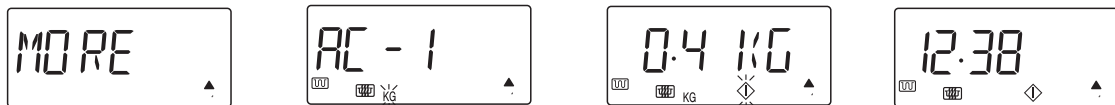

NOTE:

To cancel **LESS** or **MORE**, press the same button again.
To change **MORE** to **LESS** simply press the **LESS** (▼) button.
To change **LESS** to **MORE** simply press the **MORE** (▲) button.

b) Adjusting the heating time while oven is operating.

The cooking time can be decreased or increased in 1 minute steps each time the **LESS** (▼) and **MORE** (▲) buttons are pressed.

NOTE:

You can use this function for manual cooking only.



OTHER CONVENIENT FUNCTIONS

2. MINUTE PLUS function.

The **+1min** button allows you to operate the two following functions:

a) 1 minute cooking

You can cook on your desired cooking mode for 1 minute without entering the cooking time.

Example:

Suppose you want to cook for 1 minute at 630W microwave power.

1. Rotate the **COOKING MODE** dial to the  MICROWAVE setting.

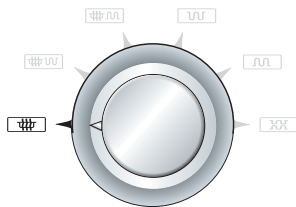

2. Press the **MICROWAVE POWER LEVEL** button twice for 630 W microwave power.

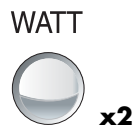



3. Press the **+1min** button to start cooking.



Display:



NOTE:

1. You can use this function for manual cooking only.
2. When the **COOKING MODE** dial is on microwave () and you press the **+1min** button, the microwave power is always 900 W. When the **COOKING MODE** dial is on dual ( or ) and you press the **+1min** button, the microwave power is always 270 W.
3. To avoid misuse by children the **1 minute cooking** function can be used only within 3 minutes after the preceding operation, ie closing the door or pressing the **STOP** button.

b) Extend the cooking time

You can extend the cooking time in multiples of one minute if the button is pressed while the oven is in operation.

NOTE:

You can use this function for manual cooking only.

OTHER CONVENIENT FUNCTIONS



3. TO CHECK THE POWER LEVEL

To check the microwave power level during cooking press the **MICROWAVE POWER LEVEL** button.

WATT As long as your finger is pressing the button, the power level will be displayed. The oven continues to count down, although the display shows the power level.



4. INFORMATION button

Each button carries useful information. If you wish to get the information, press the **INFO/CLOCK** button before pressing the desired button.

Example:

Suppose you want to get information about AUTO COOK menu number 2, Grilled Chicken:

1. Choose the **INFO/CLOCK** button function.
2. Press the **AUTO COOK** button twice to select the AUTO COOK menu AC-2.



x1



x2



Check the Display:

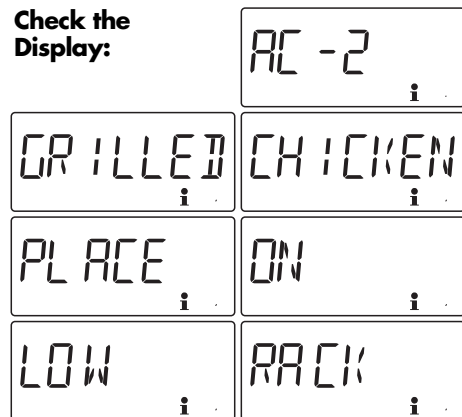

NOTE:

1. The information message will be repeated twice, and then the display will show the time of day, if set.
2. If you want to cancel the information press the **STOP** button.



AUTOMATIC OPERATION (EXPRESS PIZZA)

The **EXPRESS PIZZA** function automatically cooks frozen pizza very quickly.
What you need to know when using this automatic function:

1. The **EXPRESS PIZZA** can only be input within 3 minutes after cooking completion, closing the door or pressing the **STOP** key.
2. To increase the weight press the button until the desired weight is displayed.
Enter the weight of the food only.
For food weighing more or less than the weights given in the cooking chart, cook using PIZZA function (see pages 17 - 18) or manual operation.
3. The programmed cooking time is an average time. If you want to alter the cooking time, use the **LESS (▼)** or **MORE (▲)** buttons before pressing the **EXPRESS PIZZA** button (see page 13).
If you want the best pizza result, use the PIZZA function (P-1 Frozen Pizza), see pages 17 - 18.
4. The oven will start to cook instantly after the weight has been input.

NOTE:

The final temperature will vary according to the initial temperature. Check food is piping hot after cooking.
If necessary, you can extend the cooking time manually.

WARNING: The oven cavity, door, outer cabinet, turntable, racks, dishes and especially the bottom grill will become very hot, always use thick oven gloves when removing the food or turntable from the oven to prevent burns.

Example: To cook Frozen Pizza 0,3 kg.

1. To select the menu required and weight range, press the **EXPRESS PIZZA** button once.



After 2 seconds the oven will start to cook automatically.



EXPRESS PIZZA CHART

BUTTON	MENU	WEIGHT (Increasing Unit) / UTENSILS	PROCEDURE
	Express Frozen Pizza 	0,3/0,35/0,4 kg (50 g) (initial temp -18° C) Directly on the turntable	<ul style="list-style-type: none"> • Remove the ready prepared frozen pizza from the packaging and place on the turntable. • After cooking, place on a plate for serving.

AUTOMATIC OPERATION (PIZZA/FUN MENUS/AUTO COOK/AUTO DEFROST)



These functions automatically work out the correct cooking mode and cooking time to get the best results. You can choose from the 3 PIZZA, 3 FUN MENUS, 4 AUTO COOK and 5 AUTO DEFROST menus.

PIZZA button

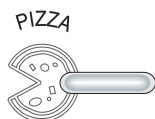

FUN MENUS button



AUTO COOK button



AUTO DEFROST button



WARNING: For all menus except AUTO DEFROST:

The oven cavity, door, outer cabinet, turntable, racks, dishes and especially the bottom grill will become very hot. Use thick oven gloves when removing food or the turntable from the oven to prevent burns.

What you need to know when using these automatic functions:

1. Menu can be input by pressing the **PIZZA**, **FUN MENUS**, **AUTO COOK** or **AUTO DEFROST** button until the desired menu number is displayed.

2. The weight of the food can be input by rotating the **TIME/WEIGHT** dial until the desired weight is displayed.

Enter the weight of the food only. Do not include the weight of the container.

For food weighing more or less than weights/quantities given in the cooking chart, cook using manual operation.

3. The programmed cooking times are average times. If you want to alter cooking times pre-programmed in the automatic operations, use the **LESS** (▼) or **MORE** (▲) buttons. For best results follow the cooking chart instructions, pages 18 - 20.

4. Press the **START** button to start cooking.

When action is required (e.g. to turn food over) the oven stops, the audible signals sound and the display shows the necessary action. To continue cooking, press the **START** button.

1. PIZZA

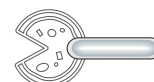

PIZZA button

2.

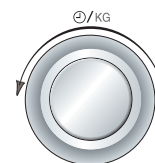

TIME/WEIGHT dial

3.

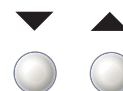

LESS/MORE buttons

4.



START button

The final temperature will vary according to the initial temperature. Check food is piping hot after cooking. If necessary, you can extend the cooking time and change the power level.

AUTOMATIC OPERATION (PIZZA/FUN MENUS/AUTO COOK/AUTO DEFROST)





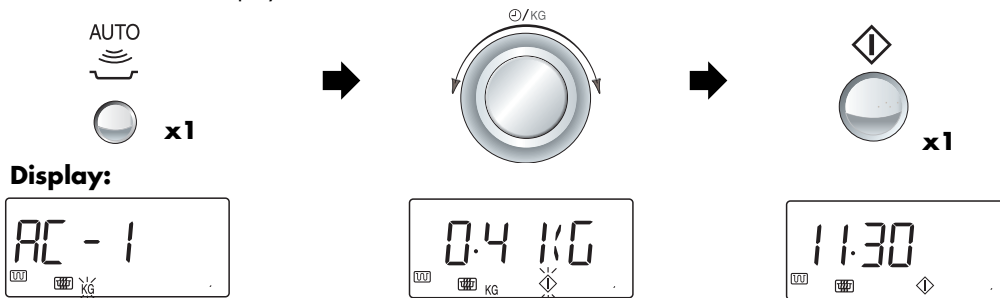

The **PIZZA**, **FUN MENUS**, **AUTO COOK** and **AUTO DEFROST** buttons offer the possibility to cook foods quickly and easily.

Example: Suppose you want to cook Grill Skewers (Kebabs) weighing 0.4 kg using the **AUTO COOK** button.

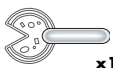
1. Choose the **AUTO COOK** menu AC-1 by pressing the **AUTO COOK** button once. Cooking information will appear. The weight indicator will flash on the display:
2. Enter the weight by rotating the **TIME/WEIGHT** dial clockwise.
3. Press the **START** button to start cooking.

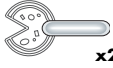

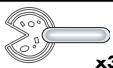
PIZZA CHART

BUTTON	MENU	WEIGHT (Increasing Unit) / UTENSILS	PROCEDURE
 x1	P-1 Pizza  Frozen Pizza	0,15 - 0,6 kg (50 g) (initial temp -18° C) Directly on the turntable	<ul style="list-style-type: none"> • Remove the ready prepared frozen pizza from the packaging and place on the turntable. For thick base pizza, press the MORE (▲) button. • After cooking, place on a plate for serving.
 x2	P-2 Pizza  Chilled Pizza	0,15 - 0,45 kg (50 g) (initial temp 5° C) Directly on the turntable	<ul style="list-style-type: none"> • Remove the ready prepared chilled pizza from the packaging and place on the turntable. • After cooking, place on a plate for serving.
 x3	P-3 Pizza  Fresh Pizza e.g. Homemade Pizza	0,7 - 1,0 kg (100 g) (initial temp 20° C) Directly on the turntable	<ul style="list-style-type: none"> • Prepare the pizza following the recipe below. • Place directly on the turntable. • After cooking, place on a plate for serving.

PIZZA RECIPE

Ingredients:

300 g Approx.	Ready prepared dough (Ready mix or roll out dough.)
200 g Approx.	Tinned tomatoes
150 g	Topping as desired (e.g. corn, ham, salami, pineapple)
50 g	Grated cheese Basil, oregano, thyme salt, pepper

Procedure:

1. Prepare the dough according to the manufacturer's instructions. Roll out to the size of the turntable.
2. Lightly grease the turntable and place the pizza base on it and pierce the dough.
3. Drain the tomatoes and cut them into pieces. Season the tomatoes with the spices and spread on the dough. Put all other ingredients on the pizza and finally cover with the cheese.
4. Cook on **P-3 Pizza** "Fresh Pizza".

FUN MENUS CHART



BUTTON	MENU	WEIGHT (Increasing Unit) / UTENSILS	PROCEDURE
 x1	C-1 Fun Menu * Frozen Baguettes e.g. Baguettes with Pizza topping or Ciabatta with topping	0,15 - 0,5 kg (50 g) (initial temp -18° C) Directly on the turntable	<ul style="list-style-type: none"> Remove the deep frozen baguettes from the packaging and place on the turntable. For Ciabatta, press the LESS (▼) button. After cooking, place on a plate for serving.
 x2	C-2 Fun Menu * Fish Fingers	0,2 - 0,5 kg (50 g) (initial temp -18° C) Directly on the turntable	<ul style="list-style-type: none"> Remove the deep frozen fish fingers from the packaging and place on the turntable. After cooking, place on a plate for serving.
 x3	C-3 Fun Menu * French Fried Potatoes (recommended for conventional ovens) e.g Standard and thick type	0,2 - 0,4 kg (50 g) (initial temp -18° C) Directly on the turntable	<ul style="list-style-type: none"> Remove the deep frozen French fried potatoes from the packaging and place on the turntable. For thick French fried potatoes, use the MORE (▲) button. After cooking, place on a plate for serving.















AUTO COOK CHART



BUTTON	MENU	WEIGHT (Increasing Unit) / UTENSILS	PROCEDURE
 x1	AC-1 Cook Grill Skewers See recipes on page XX.	0,2 - 0,8 kg (100 g) (initial temp 5° C) High rack	<ul style="list-style-type: none"> Prepare the grill skewers. Place on the high rack and cook. When the audible signal sounds turn over. After cooking, place on a plate for serving.
 x2	AC-2 Cook Grilled Chicken Ingredients for 1,2 kg grilled chicken: Salt and Pepper, 1 tsp sweet paprika, 2 tbsp oil	0,9 - 1,8 kg (100 g) (initial temp 5° C) Low rack	<ul style="list-style-type: none"> Mix the ingredients and spread on the chicken. Pierce the skin of the chicken with a fork. Put chicken breast side down on the low rack. When audible signals sound, turn the chicken over. After cooking, leave for approx. 3 minutes in the oven, remove and put on a plate for serving.
 x3	AC-3 Cook Gratinated Fish Fillet	0,6 - 1,2 kg* (100 g) (initial temp 5° C) Gratin dish Low rack	<ul style="list-style-type: none"> See recipes for Gratinated Fish Fillet on page 21. * Total weight of all ingredients.
 x4	AC-4 Cook Gratin See recipes on page XX.	0,5 - 1,5 kg* (100 g) (initial temp 5° C) Gratin dish Low rack	<ul style="list-style-type: none"> Prepare the gratin. Place the gratin on the turntable. After cooking, let the food stand, wrapped in aluminium foil, for approx. 5 minutes. * Total weight of all ingredients.



AUTO DEFROST CHART

BUTTON	MENU	WEIGHT (Increasing Unit) / UTENSILS	PROCEDURE
  x1	AD-1 Defrost  Steak and Chops	0,2 - 1,0 kg (100 g) (initial temp -18° C) (See note below for utensils)	<ul style="list-style-type: none"> Place the food on a plate in the centre of the turntable. When the oven stops and the audible signals sound, turn the food over, rearrange and separate. Shield thin parts and warm spots with aluminium foil. After defrosting, wrap in aluminium foil for 10 - 20 minutes, until thoroughly defrosted.
  x2	AD-2 Defrost  Minced Meat	0,2 - 1,0 kg (100 g) (initial temp -18° C) (See note below)	<ul style="list-style-type: none"> Place the block of minced meat on a plate in the centre of the turntable. When the oven stops and the audible signals sound, turn the food over. Remove the defrosted parts if possible. After defrosting, stand for 5 - 10 minutes, until thoroughly defrosted.
  x3	AD-3 Defrost  Poultry	0,9 - 2,0 kg (100 g) (initial temp -18° C) (See note below for utensils)	<ul style="list-style-type: none"> Place a plate upside down on the turntable and put the poultry, breast side down, on the plate. When the oven stops and the audible signals sound, turn the food over. Shield thin parts and warm spots with aluminium foil. After defrosting, cover with aluminium foil and stand for 30 - 90 minutes, until thoroughly defrosted.
  x4	AD-4 Defrost  Cake	0,1 - 1,4 kg (100 g) (initial temp -18° C) Flat dish	<ul style="list-style-type: none"> Remove all packaging from the cake. Place on a flat dish in the middle of the turntable. After defrosting, cut the cake into similar sized pieces keeping space between each piece and let stand for 15 - 70 minutes until evenly defrosted.
  x5	AD-5 Defrost  Bread	0,1 - 1,0 kg (100 g) (initial temp -18° C) Flat dish (Only sliced bread is recommended for this programme.)	<ul style="list-style-type: none"> Distribute on a flat dish in the centre of the turntable. When the audible signal sounds rearrange, and remove defrosted slices. After defrosting separate all slices and distribute on a large plate. Cover the bread with aluminium foil and let stand for 5 - 10 minutes until thoroughly defrosted.

NOTE: Auto Defrost

- Steaks and Chops should be frozen in one layer.
- Minced meat should be frozen in the thin shape.
- After turning over, shield the defrosted portions with small, flat pieces of aluminium foil.
- The poultry should be processed immediately after defrosting.
- For Steaks, Chops, Minced Meat and Poultry arrange the food in the oven as shown below:

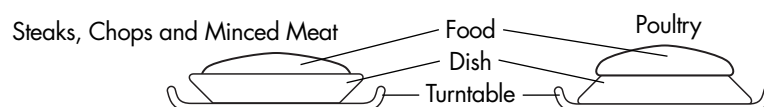



RECIPES FOR AUTO COOK AC-3



GRATINATED FISH FILLET (AC-3)

Fish Gratin Italian Style

Ingredients: 600 g Rose Fish Fillet
250 g Mozzarella. approx
250 g tomatoes
2 tbsp. anchovy butter
salt and pepper
1 tbsp chopped basil
lemon juice of 1/2 lemon
2 tbsp chopped mixed herbs
75 g grated Gouda (45 % fat)
sauce thickening powder

Procedure:

- Wash the Fish and dry. Sprinkle with lemon juice and salt and grease with the anchovy butter.
- Place in an oval gratin dish (32 cm).
- Sprinkle the gouda over the fish.
- Wash the tomatoes and remove the stalks. Cut into slices and place on top of the cheese.
- Season with salt, pepper and the mixed herbs.
- Drain the mozzarella, cut into slices and place on the tomatoes. Spread over the basil.
- Place the gratin dish on the low rack and cook on **AUTO COOK AC-3** "Gratinated Fish Fillet" (1,2 kg).

Hint: After cooking remove the fish from the gratin dish and stir in some sauce thickening powder. Cook again for 1-2 minutes on 900 W power.

GRATINATED FISH FILLET (AC-3)

Gratinated Rose Fish Fillets 'Esterhazy'

Ingredients: 600 g Rose Fish Fillet
250 g Leeks
50 g onion
100 g carrot
1 tbsp. butter
salt, pepper and nutmeg
2 tbsp. lemon juice
125 g crème fraîche
100 g grated Gouda (45 % fat)

Procedure:

- Wash the leeks and divide in 2 parts from top to bottom. Cut into thin strips.
- Peel the onions and carrots and cut into thin strips.
- Put the vegetables, butter and spices into a casserole dish and mix well. Cook for 5-6 minutes on 900 W power. Stir once in-between cooking.
- In the meantime wash the fish fillet, dry and sprinkle with lemon juice and salt.
- Mix the Crème fraîche under the vegetables and season again.
- Put half of the vegetables in an oval gratin dish (32 cm). Place the fish on top and cover with the remaining vegetables.
- Spread over the Gouda and place on the low rack. Cook on **AUTO COOK AC-3** "Gratinated Fish Fillet" (1,2 kg).

GRATINATED FISH FILLET (AC-3)

Gratinated Rose Fish - Broccoli.

Ingredients: 500 g Rose Fish Fillet
2 tbsp. lemon juice
1 tbsp. butter
2 tbsp flour
300 ml milk
chopped dill, pepper and salt
250 g frozen broccoli
100 g grated Gouda (45 % fat)

Procedure:

- Wash the fish fillet and dry. Sprinkle with lemon juice and salt.
- Heat together butter and flour in a casserole dish without cover for 1-1½ mins on 900 W power.
- Add the milk and stir well. Cook again without cover for 3-4 minutes on 900 W power. After cooking stir and season with dill, salt and pepper.
- Defrost the broccoli in a casserole dish for 4-6 mins on 900 W power. Once defrosted, place the broccoli into a gratin dish (32 cm) and put the fish on top and season.
- Pour the sauce over and sprinkle over the cheese
- Place on low rack and cook on **AUTO COOK AC-3** "Gratinated Fish Fillet" (1,1 kg).





CARE AND CLEANING

CAUTION: DO NOT USE COMMERCIAL OVEN CLEANERS, ABRASIVE, HARSH CLEANERS OR SCOURING PADS ON ANY PART OF YOUR MICROWAVE OVEN.

WARNING!

After GRILL, DUAL and AUTOMATIC operation (except Auto Defrost) modes, the oven cavity, door, oven cabinet and accessories will become very hot. Before cleaning, make sure they have cooled down.

Oven exterior

The outside of your oven can be cleaned easily with mild soap and water. Make sure the soap is wiped off with a moist cloth, and dry the exterior with a soft towel.

Oven controls

Open the door before cleaning to de-activate the oven controls. Care should be taken when cleaning the oven control. Using a cloth dampened with water only, gently wipe the panel until it becomes clean. Avoid using excessive amounts of water. Do not use any sort of chemical or abrasive cleaner.

Oven Interior

1. For cleaning, wipe any splatters or spills with a soft damp cloth or sponge after each use while the oven is still warm. For heavier spills, use a mild soap and wipe several times with a damp cloth until all residues have been removed. Do not remove the waveguide cover.
2. Make sure that mild soap or water does not penetrate the small vents in the walls which may cause damage to the oven.
3. Do not use spray type cleaners on the oven interior. Do not use a steam cleaner.
4. Heat up your oven regularly by using both heating elements, refer to "Heating without food" on page 11. Remaining food or fat splashed on the oven interior can cause smoke or a bad smell.

Turntable

Remove the turntable. Wash the turntable in mild soapy water. Dry with a soft cloth. The turntable is dishwasher safe.

Low Rack and High Rack

These should be washed in a mild washing up liquid solution and dried. High and Low racks are dishwasher safe.

Door

To remove all trace of dirt, regularly clean both sides of the door, the door seals and adjacent surfaces with a soft, damp cloth.

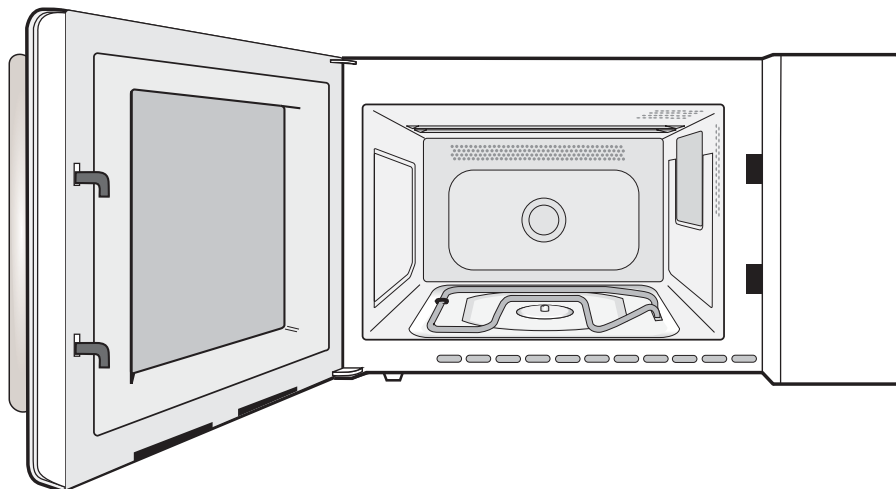

SERVICE CALL CHECK



PLEASE CHECK THE FOLLOWING BEFORE CALLING FOR SERVICE:

1. Power Supply:
 Check the power plug is properly connected to a suitable wall outlet.
 Check the line fuse/circuit breaker is functioning properly.
2. When the door is opened, does the oven lamp turn on? YES _____ NO _____
3. Place a cup of water (approx. 150 ml) in the oven and close the door securely.
 Set the **COOKING MODE** dial to microwave setting.
 Programme the oven for one minute on 900 W power and start the oven.
 Does the oven lamp come on? YES _____ NO _____
 Does the turntable rotate? YES _____ NO _____
NOTE: The turntable turns in either direction.
 Does the ventilation work? YES _____ NO _____
 (Place your hand over the ventilation openings and check for air flow.)
 After 1 minute does the signal sound? YES _____ NO _____
 Does the cooking in progress indicator go off? YES _____ NO _____
 Is the cup of water warm after the above operation? YES _____ NO _____
4. Set the **COOKING MODE** dial to the TOP & BOTTOM GRILL setting for 3 minutes. After 3 minutes do both GRILL heating elements become red? YES _____ NO _____

If you answer "NO" to any of the above questions, call a Service Technician appointed by SHARP and report the results of your check. See inside back cover for details of address.

IMPORTANT: If the display shows nothing even if the power plug is properly connected, the energy save mode should carry on. To release it, open the oven door. See page 8.

NOTE:

1. If you cook the food over the standard time with only the same cooking mode, the power of the oven will lower automatically to avoid overheating. (The microwave power level will be reduced and the grill heating elements will begin to light on and off.)

Cooking mode	Standard time
Microwave 900 W cooking	20 min.
Grill cooking	
TOP GRILL	15 min.
BOTTOM GRILL	15 min.
TOP and BOTTOM GRILL	Top grill - 6 min. Bottom grill - 6 min.
Dual 1	Micro - 20 min. Top grill - 15 min.
Dual 2	Micro - 20 min. Bottom grill - 15 min.

2. After the GRILL (using both heating elements), DUAL and AUTOMATIC OPERATION (except AUTO DEFROST), the cooling fan will run and "NOW COOLING" will appear on the display. Also, when you press the **STOP** button and open the door during the GRILL, DUAL and/or automatic cooking (except AUTO DEFROST), the cooling fan will run; you may, therefore, feel air blowing from the ventilation openings.



• SERVICE NIEDERLASSUNGEN • ADDRESSES D'ENTRETIEN • ONDERHOUDSADRESSEN • DIRECCIONES DE SERVICIO • INDIRIZZI DI SERVIZIO •

ÖSTERREICH

Bei einer Reklamation Ihrer SHARP Mikrowelle wenden Sie sich bitte an Ihren Fachhändler oder an eine der nachfolgend aufgeführten SHARP SERVICE Niederlassungen.

Manfred Mayer GmbH, Stipcakgasse 6, 1234 Wien, Phone: 01-6093120, Fax: 01-6993629 / **MCL-Service GmbH**, Deutschstr. 19, 1232 Wien, Phone: 01-6168800, Fax: 01-6168800-15 / **Karl Rother**, Simmeringer Hauptstr. 11, 1110 Wien, Phone: 01-7498432, Fax: 01-7498432-12 / **Roland Göschl**, Bayerhamerstr. 12c, 5020 Salzburg, Phone: 662-882307, Fax: 662-881926 / **Franz Schuhmann**, Gablonzerweg 18, 4030 Linz, Phone: 732-382280, Fax: 732-382280-8 / **Arnold Moser**, An der Heufurt 28, 6900 Bregenz, Phone: 5574-75777, Fax: 5574-75777 / **Anton Reitmeir**, Leopoldstr. 57, 6020 Innsbruck, Phone: 512-562277, Fax: 512-562277 / **Scheuermann**, Rennsteinerstr. 8, 9500 Villach, Phone: 4242-21174, Fax: 4242-21174 / **Pichler**, Am Wagrain 342, 8055 Graz, Phone: 316-291292, Fax: 316-291292 / **Audio Video Service**, Sonnengasse 13, 9020 Klagenfurt, Phone: 463-43114, Fax: 463-43113

BELGIUM

En cas d'une réclamation concernant une four a micro-onde SHARP, nous vous prions de vous adresser à votre spécialiste ou à une adresse des SHARP Services suivantes.

Indien uw magnetron problemen geeft kunt u zich wenden tot uw dealer of een van de onderstaande Sharp service centra.

SHARP ELECTRONICS, Phone: 0900-10158, Web: <http://www.sharp.be>

AVTC, Kleine Winkellaan 54, 1853 Strombeek-Bever, Phone: 02/2674019, Fax: 2679670,

ETS HENROTTE, Rue Du Campinaire 154, 6240 Farciennes, Phone: 071/396290, Fax: 391237

Nouvelle Central Radio (N.G.R) Rue des Joncs 15 L-1818 HOWALD Phone: 00352404078, Fax. 2402085

NEDERLAND

Indien uw magnetron problemen geeft kunt u zich wenden tot uw dealer of naar onderstaand Sharp Service Centrum.

SHARP ELECTRONICS BENELUX BV, - Helpdesk -, Postbus 900, 3990 DW Houten, Telefoon: 0900-7427723,

Web: <http://www.sharp.nl>

DEUTSCHLAND

Bei einer Reklamation Ihrer SHARP Mikrowelle wenden Sie sich bitte an Ihren Fachhändler oder an eine der nachfolgend aufgeführten SHARP SERVICE Niederlassungen.

03048 Groß Garglow, Cottbuser Str. 129, Bernd Mindach, Tel: 0355-539987, Fax: 0355-5265685 / **04159 Leipzig**, Max-Liebermann-Straße 4a, Rudi Franz, Tel: 0341-9112525, Fax: 0341-9112526 / **04600 Altenburg**, Gabelentzstraße 15A, Mechanik Altenburg E.G., Tel: 03447-311102, Fax: 03447-315253 / **06217 Merseburg**, Gotthardstraße 30, "Looke & May, GmbH", Tel: 03461-214121, Fax: 03461-216891 / **06295 Eisleben**, Hallesche Straße 36, Hausger. Kundend. Eisleben, Tel: 03475-603079, Fax: 03475-747262 / **06618 Naumburg**, Wenzelstraße 15, "Hausgeräte & Service, GmbH", Tel: 03445-202016, Fax: 03445-202016 / **06844 Dessau**, Albrechtstraße 116-118, "Dessau-Electric, GmbH", Tel: 0340-261270, Fax: 0340-213332 / **07407 Rudolstadt**, Emil Hartmann Straße 2, Elektro Ernst Granowski, Tel: 03672-352123, Fax: 03672-357097 / **07545 Gera**, Amthorstraße 12, "Ess Hardware Service, GmbH", Tel: 0365-8820115, Fax: 0365-8820116 / **07973 Greiz**, Reichenbacher Straße 44d, Elektro Riederer Haushaltgeräte, Tel: 03661-3148, Fax: 03661-430142 / **08280 Aue**, Bahnhofstraße 21, "EHS Elektro-Hausgeräte SVC, GmbH", Tel: 03771-552222, Fax: 03771-552255 / **08523 Plauen**, Weststraße 63, "Elektrotechnik Plauen, GmbH", Tel: 03741-2120, Fax: 03741-212259 / **09221 Neukirchen**, Hauptstraße 74, Walther Elektro, Tel: 0371-217096, Fax: 0371-217090 / **09246 Pleiße**, Zeppelinstraße 8a, "Hans Krempel Haustechnik, GmbH", Tel: 03722-73780, Fax: 03722-737822 / **09328 Lunzenau**, Schulstraße 6, "Peter Welsch, GmbH", Tel: 037383-6434, Fax: 037383-6448 / **09376 Oelsnitz**, Bahnhofstraße 43, "Elektrotechnik Oelsnitz, GmbH", Tel: 037298-2677, Fax: 037298-2678 / **12157 Berlin**, Cranachstraße 2, Michael Kittler, Tel: 030-85602602, Fax: 030-85602603 / **16866 Kyritz**, Hamburgerstr. 31, "Schumacher Haustechnik, GmbH", Tel: 033971-54137, Fax: 033971-54137 / **18055 Rostock**, Timmermannstrat 5, Hetec, Tel: 0381-36231, Fax: 0381-36231 / **18435 Stralsund**, Kedingshäger Straße 78, "RDS Haushaltsgeräte, GmbH", Tel: 03831-391426, Fax: 03831-390121 / **20357 Hamburg**, Schullerblatt 132, Dieter Müller, Tel: 040-435332, Fax: 040-4302120 / **20537 Hamburg**, Eiffelstraße 398, "Deubel+Höfermann Elektronik, GmbH", Tel: 040-41365200, Fax: 040-41365299 / **22459 Hamburg**, Seesrein 35, Dieter A. Volbrecht VDI Klima und Kälte Service, Tel: 040 - 5517331, Fax: 040 - 5519996 / **23562 Lübeck**, Helmholtzstraße 12, Lutz H. Boenisch, Tel: 0451-51929, Fax: 0451-56787 / **24116 Kiel**, Eckernförder Straße 93, "Jürgen Skop, GmbH", Tel: 0431-13038, Fax: 0431-13811 / **24357 Fleckeby**, Südring 14, "Kaack Elektro-Haushaltgeräte Service, GmbH", Tel: 04354-700, Fax: 04354-1311 / **24975 Husby**, Flensburger Straße 41, Günter Josten, Tel: 04634-422, Fax: 04634-723 / **25770 Hemmingstedt**, Koelsiner Straße 18, Dirk Stübner Dithmarscher Hausgeräte Service, Tel: 0481-64943, Fax: 0481-64764 / **26655 Westerstede**, Südring 37, "Gerhard Ahrenholtz, GmbH", Tel: 04488-84770, Fax: 04488-847711 / **27404 Heeslingen**, Kirchstraße 9-11, Helmut Willenbrock Elektro-Kälte-Radio, Tel: 04281-1031, Fax: 04281-6467 / **27478 Cuxhaven**, Am Kanal 5, Oskar Wieandt & Sohn OHG, Tel: 04724-81300, Fax: 04724-813050 / **28207 Bremen**, Neidenburger Straße 20, "Hansa Haushaltsgeräte Service, GmbH", Tel: 0421-492526, Fax: 0421-440932 / **29439 Lüchow**, Güldenboden 25, Elektro-Kittler, Tel: 05841-709779, Fax: 05841-709780 / **30926 Seelze**, Lange-Feld-Straße 122, Strickling Werkkundendienst, Tel: 0511-4003999, Fax: 0511-40039920 / **34123 Kassel**, Heinrich-Hertz-Straße 9, KälteDienst v. Rappard, Tel: 0561-5809545, Fax: 0561-5809570 / **34128 Kassel**, Ahnatalstraße 84, Elektro Mohrrhenne, Tel: 0561-61727, Fax: 0561-65470 / **35037 Marburg**, Wilhelmstraße 16, Hans-Georg Fuchs, Tel: 06421-22424, Fax: 06421-27549 / **35415 Pohlheim**, Ludwigstraße 13-15, Jung KDZ, Tel: 06403-61131, Fax: 06403-62151 / **36088 Hünfeld**, Hauptstr. 22, Elektro Vogt, Tel: 06652-2215, Fax: 06652-5782 / **37671 Höxter**, Krämerstraße 8, Elektro Nonn, Tel: 05271-7959, Fax: 05271-35053 / **38444 Wolfsburg**, Brandgehaege 5 C, Gärtner Elektro-Haustechnik, Tel: 05308-4070, Fax: 05308-40740 / **39106 Magdeburg**, Ankerstr. 9, "Industrie-Elektronik Magdeburg, GmbH", Tel: 0391-5430402, Fax: 0391-5433520 / **40476 Düsseldorf**, Rather Straße 21, Horst Leven, Tel: 0211-486025, Fax: 0211-443399 / **41065 Mönchengladbach**, Gutenbergstraße 28, Horst Hommers Kundendienst-Center, Tel: 02161-603256u.57, Fax: 02161-651951 / **42781 Haan**, Talstraße 8b, Horst Kerkühn Elektro-Haustechnik, Tel: 02129-4466+53550, Fax: 02129-34037 / **44869 Bochum**, Ruhrstraße 181, "ML Werks-Service, GmbH", Tel: 02327-77899, Fax: 02327-74692 / **45219 Essen**, Corneliussstraße 39, R. Drengenburg, Tel: 02054-84114, Fax: 02054-15238 / **46045 Oberhausen**, Feldmannstraße 76, Dieter Kroppen, Tel: 0208-871711, Fax: 0208-876652 / **48165 Münster-Hiltrup**, Rohrkampstraße 23, Günter Pfeifer Großküchentechnik, Tel:



• SERVICE NIEDERLASSUNGEN • ADDRESSES D'ENTRETIEN • ONDERHOUDSADRESSEN • DIRECCIONES DE SERVICIO • INDIRIZZI DI SERVIZIO •

02501-3033, Fax: 02501-24277 / **49324 Melle, Plettenberger** Straße 50, "H. U. Borgards, GmbH", Tel: 05422-949740, Fax: 05422-949792 / **51598 Friesenhagen**, Mühlenhof 6, "Hans Krempel Haustechnik, GmbH", Tel: 02734-7377, Fax: 02734-40618 / **52146 Würselen**, De Gasperistraße 6+10, Hubert Hamacher, Tel: 02405-9600+9609, Fax: 02405-2704 / **53757 Sankt Augustin**, Bussardstraße 120, "HDL Elektro-Kundendienst, GmbH", Tel: 02241-920330, Fax: 02241-920334 / **55130 Mainz**, Nur telefonische Annahmestelle, "Norbert Schwamb, GmbH", Tel: 06131-881070 / **55543 Bad Kreuznach**, Industriestraße, "Hans Krempel Haustechnik, GmbH", Tel: 0671-794335, Fax: 0671-794369 / **56070 Koblenz**, August-Horch-Straße 14, "Hans Krempel Haustechnik, GmbH", Tel: 0261-8909173, Fax: 0261-8909199 / **57080 Siegen**, Gosenbacher Hütte 44, "Hans Krempel Haustechnik, GmbH", Tel: 0271-354114, Fax: 0271-351408

58239 Schwerte, Holzener Weg 79, "HHKT Electronica 2000 Josef Schlütz, GmbH", Tel: 02304-982100, Fax: 02304-86360 / **59457 Werl**, Westdahl Weg 2, MAYER Electro, Tel: 02922-3541, Fax: 02922-85382 / **61381 Friedrichsdorf**, Bahnstraße 17 a, O. Hallmann, Tel: 06172-778276, Fax: 06172-75883 / **63739 Aschaffenburg**, Maximilianstraße 8, Radio-Fernseh Reis, Tel: 06021-15177, Fax: 06021-15199 / **65239 Hochheim**, Eltviller Straße 14, "Norbert Schwamb, GmbH", Tel: 06146-4085, Fax: 06146-4088 / **65627 Elbtal-Hangenmeilingen**, Am Ohlenrod 10, Rudi Wagner, Tel: 06436-3444, Fax: 06436-941387 / **65931 Frankfurt**, Nur telef. Annahmestelle, "Norbert Schwamb, GmbH", Tel: 069-371525 / **66117 Saarbrücken**, Zinzinger Straße 13, "Hans Krempel Haustechnik, GmbH", Tel: 0681-5008522, Fax: 0681-5008533 / **67434 Neustadt**, Saarlandstraße 55, "Hans Krempel Haustechnik, GmbH", Tel: 06321-83077, Fax: 06321-83077 / **68309 Mannheim**, Heppenheimerstraße 23, "Hans Krempel Haustechnik, GmbH", Tel: 0621-7184621, Fax: 0621-7184628 / **68526 Ladenburg**, Am Sägewerk 2, Elektro Service Salinger, Tel: 06203-3341, Fax: 06203-16919 / **70186 Stuttgart**, Klippeneck Straße 1, Elektro Herterich Techn. Kundendienst, Tel: 0711-4687023, Fax: 0711-4687024 / **75236 Kämpfelbach**, Goethestraße 19, Horst Frei, Tel: 07232-1518, Fax: 07232-5238 / **76185 Karlsruhe**, Lotzbeckstraße 9, Electronic Service Franke, Tel: 0721-5700720-23, Fax: 0721-5700736 / **76872 Winden**, Hauptstraße 103, "Hans Krempel Haustechnik, GmbH", Tel: 06349-8571, Fax: 06349-3390 / **78462 Konstanz**, Nur telef. Annahmestelle, Elektro Herterich, Tel: 07531-27923 / **78737 Fluorn-Winzeln**, Schafbaumstraße 9, Edmund Schneider, Tel: 07402-482, Fax: 07402-8014 / **79650 Schopfheim**, Feldbergstraße 21, R. Grossmann, Tel: 07622-674510, Fax: 07622-61900 / **80339 München**, Schwantthalerstraße 110, Kesel & Schnitt, Tel: 089-505802, Fax: 089-5021596 / **85095 Denkendorf/Zandt**, Michlstraße 3, Elektro Pfeiffer, Tel: 08466-1319, Fax: 08466-1319 / **86157 Augsburg**, Stadtberger Straße 67, J. Haslinger Elektro-Geräte Kundendienst, Tel: 0821-523125, Fax: 0821-526664 / **87439 Kempten**, Heiligkreuzer Straße 17, Radio Hartmann, Tel: 0831-594646, Fax: 0831-91319 / **89231 Neu-Ulm**, Gartenstraße 4, Elektrotechnik Schneider, Tel: 0731-85897, Fax: 0731-74681 / **91522 Ansbach**, Am Ring 17, "Elektro Merk, GmbH", Tel: 0981-89574, Fax: 0981-86715 / **92820 Feucht/Nürnberg**, Friedrich-Ebert-Straße 21, "Herbert Geissler, GmbH", Tel: 09128-70760, Fax: 09128-707636 / **93102 Pfatter**, Regensburger Straße 60, Franz Bernhard, Tel: 09481-90060, Fax: 09481-90061 / **94130 Oberzell**, Hameter Straße 31, Elektro Service Schurig, Tel: 08591-2400, Fax: 08591-1285 / **96052 Bamberg**, Aronstraße 2a, Bernhard Jackl, Tel: 0951-9370245, Fax: 0951-9370247 / **97070 Würzburg**, Untere Johannitergasse 16, "Radio Wels City Service, GmbH", Tel: 0931-3557119, Fax: 0931-14151 / **97318 Kitzingen**, Herrstraße 4-6, "Hoffritz, GmbH", Tel: 09321-4221-32021, Fax: 09321-32185 / **98724 Neuhaus**, Eisfelder Straße 32, "DLC Haustechnik, GmbH", Tel: 03679-79060, Fax: 03679-790620 / **99096 Erfurt**, Goethestraße 14, Ernst Grüsser, Tel: 0361-3465719, Fax: 0361-3465719 / **99734 Nordhausen**, Töpferstraße 10, "Südhärzer Dienstleistungs-Gesellschaft, GmbH", Tel: 03631-983651, Fax: 03631-983654 / **99817 Eisenach**, Bahnhofstraße 17, "Blitz Elektro-Elektronik, GmbH", Tel: 03691-292930, Fax: 03691-292915

FRANCE

En cas de réclamation pour les fours micro-ondes SHARP, nous vous prions de vous adresser à votre spécialiste ou à l'une des stations techniques agréées SHARP suivantes :

A.A.V.I. : 1, rue du Mont de Terre, 59818 Lesquin Cédex. Tél : 03 20 62 18 98 - Fax : 03 20 86 20 60. Départements desservis : 02, 08, 59, 62, 80 / **ASYSTEC** : P.A. Charles de Gaulle, 4 rue des Artisans, 95190 Goussainville. Tél : 01 39 88 80 00 - Fax : 01 34 38 91 20. Départements desservis : 60, 77, 93, 95 / **ATELIER ROUSSEL** : 12, Bld Flandre Dunkerque, 56100 Lorient. Tél : 02 97 83 07 41 - Fax: 02 97 87 02 36. Départements desservis : 22, 29, 35, 44, 56 / **C.E.A.T.** : 9, Rue de Venise, 21000 Dijon. Tél : 03 80 66 15 57 - Fax: 03 80 67 12 36. Départements desservis : 10, 21, 25, 39, 52, 58, 71, 89 / **C.M.T.S.** : 38, Rue des Ormeaux, 75020 Paris. Tél : 01 43 70 20 00 - Fax: 01 43 70 36 46. Départements desservis : 75, 77, 78, 91, 92, 93, 94, 95 / **C.T.E.** : Zone Tilly - 116 rte de Thionville, 57140 Woippy. Tél : 03 87 30 14 14 - Fax: 03 87 30 85 07. Départements desservis : 51, 54, 55, 57, 88 / **ELECMA** : 6 Bld Guidon, 13013 Marseille. Tél : 04 91 06 22 56 - Fax : 04 91 06 22 90. Départements desservis : 13, 26, 30, 34, 43, 48, 83, 84 / **ELECTRO SERVICE** : 21 rue de Mulhouse, BP 122, 68313 ILLZACH. Tél : 03 89 62 50 00 - Fax : 03 89 50 80 14. Départements desservis : 67, 68, 70, 90 / **M.E.C.** : 118 Bld Tonnellé, 37020 Tours. Tél : 02 47 77 90 90 - Fax : 02 47 77 90 91. Départements desservis : 18, 36, 37, 41, 45, 44, 49, 79, 85, 86 / **M.R.T.** : 74, Rue Albert Einstein, 72021 Le Mans Cedex. Tél : 02 43 28 52 20 - Fax: 02 43 24 93 81. Départements desservis : 28, 53, 61, 72 / **ROSSIGNOL** : ZL du Brezet Est, 6 rue P. Boulanger, 63100 Clermont Ferrand. Tél : 73 91 93 09, Fax: 73 92 28 79. Départements desservis : 3, 15, 19, 23, 43, 63 / **SETELEC** : 23, Rue du Chatelet, 76420 Bihorel les Rouen. Tél : 35 60 64 39 - Fax: 35 59 93. 48. Départements desservis : 14, 27, 50, 76 / **S.T.E.** : 3, Chemin de l'Industrie, 06110 Le Cannet Rocheville. Tél : 93 46 05 00 - Fax: 93 46 51 18. Départements desservis : 04, 06 / **S.T.V.S.** : 18, Rue Benoit Malon, 42000 Saint Etienne. Tél : 77 32 74 57, Fax: 77 37 45 29. Départements desservis : 03, 07, 42, 43, 63 / **S.T.V.S.** : 10, Chemin Saint-Gobain, 69190 Saint Fons. Tél : 78 70 03 32 - Fax: 78 70 86 61. Départements desservis : 01, 38, 69, 71, 73, 74 / **TECH SERVICE** : Batiment G-impasse Boudeville, 31100 Toulouse. Tél : 61 44 98 45 - Fax: 62 14 16 13. Départements desservis : 09, 11, 31, 32, 33, 40, 47, 64, 65, 66, 81, 82 / **TIMO VIDEO** : 29 rue Elisabeth, 91330 Yverres. Tél : 69 48 04 80 - Fax: 69 83 36 10. Départements desservis : 28, 45, 77, 89, 912, 94 / **U.N.T.D.** : 1, Rue des Lourdes, 76000 Rouen. Tél : 35 72 28 04 - Fax: 35 73 18 32. Départements desservis : 14, 27, 50, 76

ITALIA

NEL CASO SI VERIFICASSERO PROBLEMI ALLA VOSTRA APPARECCHIATURA POTRETE RIVOLGERVI PRESSO UN NOSTRO CENTRO DI ASSISTENZA AUTORIZZATO SHARP

C.A.T. Di Bellone, Via Dell'areoport, 76, 64100, Teramo, Tel: 0861415745, Fax: 0861212117 / **C.R. Elettronica**, Via Amiternum 38, 67100, L'Aquila, Tel: 0862-321442, Fax: 0862-314323 / **Elettrovideo Snc**, Via Tiburtina V. 64, 65124, Pescara, Tel: 08552020, Fax: 085-52020 / **Riccardi Cosimo**, Via S.Stefano 51, 75100, Matera, Tel: 0835-333671, Fax: 0835-333671 / **Ld Service Di Lavano E De Biasi**, Via Viviani 2, 85100, Potenza, Tel: 0971-472578, Fax: 0971-472578 / **Cozzupoli & Crupi Snc**, Via R. Campi Primo Tronco 103, 89126, Reggio Calabria, Tel: 0965-24022, Fax: 0965-310778 / **Ater Snc**, Via Naz.Pentimelle 159/AB, 89100, Reggio Calabria, Tel: 0965-47051, Fax: 0965-47855 / **Audiovideo Snc**, Via A. De Gasperi 44, 88018, Vibo Valentia, Tel: 0963-

• SERVICE NIEDERLASSUNGEN • ADDRESSES D'ENTRETIEN • ONDERHOUDSADRESSEN • DIRECCIONES DE SERVICIO • INDIRIZZI DI SERVIZIO •

45571, Fax: 0963-45572 / **Battaglia Saverio**, Via C. Colombo 85, 88063, Catanzaro, Tel: 0961-33824, Fax: 0961-737337 / **Ciano Giuseppe**, Via Circonvallaz.Sud, 89029, Taurianova Rc, Tel: 0966-643483, Fax: 0966-614946 / **Lab. Tv Dei F.Lli Aiello Snc**, Via Torino 121/123, 88074, Crotona Cz, Tel: 0962-20889, Fax: 0962-24254 / **Mea Giuseppe**, Via L. Einaudi Trav.I 16, 88048, Lamezia T. (Cz), Tel: 0968-437520, Fax: 0968-437520 / **Medaglia Giolindo**, Via Torrazzo 60/62, 88063, Catanzaro Lido, Tel: 0961-31626, Fax: 0961-31626 / **S.A.T.E Di Dodaro**, Via Degli Stadi 28/F, 87100, Cosenza, Tel: 0984-482337, Fax: 0984-482337 / **Se.Ri.El.Co.**, V.Delle Medaglie D'oro 163, 87100, Cosenza, Tel: 0984-33152, Fax: 0984-33152 / **Satep Srl**, Via Naz.Delle Puglie 176/A, 80026, Casoria (Na), Tel: 081-7590161, Fax: 081-7590706 / **Audio Service Snc**, Via Cattaneo 4/6, 81100, Caserta, Tel: 0823-329099, Fax: 0823-353686 / **Drf Eletr.** Di Rubbo, Via M.Pacifico 118, 82100, Benevento, Tel: 0824-62416, Fax: 0824-62416 / **Elektronica D'Argenio**, Via Nazion. Torrette, 195, 83013, Mercogliano (Av), Tel: 0825-681590, Fax: 0825-681590 / **Elektronica Service**, Viale Europa, 15, 80053, Castell. Stabia, Tel: 081-8728280, Fax: 081-8728280 / **Errediesse Service**, Via P. Mascagnani 74/76, 80128, Napoli, Tel: 081-5794825, Fax: 081-5791899 / **M.C. Elektronica Snc**, Via Dei Mille 138, 84100, Salerno (Sa), Tel: 089-330591, Fax: 089-336836 / **Menna Elektronica Srl**, Via Nazionale Delle Puglie 294, 80026, Casoria (Na), Tel: 081-5840726, Fax: 081-7594277 / **Satec Di Correria Snc**, Via Liberta' 307, 81024, Maddaloni (Ce), Tel: 0823-341088, Fax: 0823-343011 / **Video Eletr. 2 Di Nasti**, Via Ant.Pio 74/76, 80126, Napoli, Tel: 081-7676300, Fax: 081-7284347 / **Audio Video Center Snc**, Via F. Vandelli 23/29, 41100, Modena, Tel: 059-235219, Fax: 059-210265 / **Ass.Electron Di Fogli**, Via F.Lli Aventi 19, 44100, Ferrara, Tel: 0532-903250, Fax: 0532-903250 / **Ma.Pi. Snc**, Via T.Azzolini 3, 40132, Bologna, Tel: 051-6414115, Fax: 051-406848 / **Masini Service**, Via Mediterraneo 24, 47041, Bellaria (Fo), Tel: 0541-347714, Fax: 0541-324413 / **Nuova Tecnocoop**, Via Armellini 28/30/32, 47037, Bellariva Rimini, Tel: 0541-370812, Fax: 0541-370812 / **Parmaservice Sas**, Via Benedetta 47/A, 43100, Parma, Tel: 0521-271666, Fax: 0521-271666 / **Rimpelli Nelusco Snc**, Via Marchelli 7/C, 42100, Reggio Emilia, Tel: 0522-323740, Fax: 0522-376967 / **Rip.Eletr.Ravenna**, Via Reale, 27/C 48010, Camerlona (Ra), Tel: 0544-521500, Fax: 0544-521100 / **Rte Di I. Catellani & C.**, Via Premuda 38/V, 42100, Reggio Emilia (Re), Tel: 0522-381277, Fax: 0522-381788 / **Stema Snc**, V.Le Bologna, 92/A 47100, Forlì, Tel: 0543-704475, Fax: 0543-702742 / **Technolab Snc**, Via Romea 36, 48100, Ravenna, Tel: 0544-64008, Fax: 0544-476497 / **Tecnoservice.Com**, Via Longhi 16/A/B, 40128, Bologna, Tel: 051-360986, Fax: 051-366863 / **A.V.R. Sas Di Di Renzo**, Via Colonna 20/8, 33170, Pordenone, Tel: 0434-27669, Fax: 0434-523661 / **Astec S.N.C. Di Zoccarato**, Via Pecenco 4, 34127, Trieste, Tel: 040-574745, Fax: 040-577923 / **Cm Elektronica Snc**, Via G.Galilei 2, 33010, Tavagnacco (Ud), Tel: 0432-572172, Fax: 0432-573788 / **Contr.El.**, Via Rossetti 51/C, 34141, Trieste, Tel: 040-368387, Fax: 040-638117 / **Tecnoffly Snc**, Via Cappuccini 11/2, 34170, Gorizia, Tel: 0481-32732, Fax: 0481-546740 / **A.P. Rip. Arduini Piero**, Via Licinio Refice 192, 03100, Frosinone, Tel: 0775-291267, Fax: 0775-291267 / **Centro E.L.Va. Snc**, Via Attilio Mori 19/21, 00176, Roma, Tel: 06-2148641, Fax: 06-2753048 / **El.S.A.R.**, Via S.Sotero 36, 00165, Roma, Tel: 06-6380516, Fax: 06-6380973 / **Elektronica 81**, Via Ezio 56/58, 04100, Latina, Tel: 0773-694608, Fax: 0773-663511 / **Italreg Di Abano**, Parco Belvedere Conca 74, 04024, Gaeta, Tel: 0771-470851, Fax: 0771-470851 / **Palmieri F.**, Via S.Polledrara 219, 03100, Frosinone, Tel: 0775-291485, Fax: 0775-291485 / **S.A.R.E. S.R.L.**, Via Barbana 35/37, 00142, Roma, Tel: 06-5406796, Fax: 06-5412736 / **Video Serv. Sas Di Calabrese**, Str Teverina Km 2, 400 L. Pantanese, 01100, Viterbo (Vt), Tel: 0761-251557, Fax: 0761-251558 / **Caudullo Salvatore**, Via Cavour 11/R, 17100, Savona, Tel: 019-8386251, Fax: 019-829654 / **Centro Assistenza Tecn.**, Via Metella 3, 18039, Ventimiglia (Im), Tel: 0184-239011, Fax: 0184-239015 / **G.A.T.E. Snc**, Passo P.Carraga 24/A, 16141, Genova, Tel: 010-8361543, Fax: 010-8364571 / **Gse S.R.L.**, Via Rimassa 183 R, 16122, Genova (Ge), Tel: 010-5536076, Fax: 010-5536113 / **Rapisarda G.**, Via Argine Destro 299, 18100, Imperia, Tel: 0183-710771, Fax: 0183-710771 / **Rien Snc**, Via Valle 17/19, 19124, La Spezia, Tel: 0187-21925, Fax: 0187-21925 / **Tognetti Snc**, Via Lunigiana 589, 19100, La Spezia, Tel: 0187-507656, Fax: 0187-507656 / **A.E. Snc**, V.Acerbi 28, 20161, Milano, Tel: 02-66220906, Fax: 02-6466930 / **A.T. Electronics**, Via G. Da Cermentate 76, 20141, Milano, Tel: 02-89501602, Fax: 02-89502937 / **C.A.T. Bm**, Via Per Desio 22, 20030, Bovisio Masciago (Mi), Tel: 0362-558421, Fax: 0362-558887 / **Cat Electronic Snc**, Via Togliatti 8, 20077, Melegnano (Mi), Tel: 02-9834498, Fax: 02-9837559 / **Crel S.N.C.**, Via Carducci, 23100, Sondrio, Tel: 0342-216538, Fax: 0342-216538 / **Electronic's Center**, Via G.Giulini 9, 22100, Como, Tel: 031-279820, Fax: 031-261791 / **Elektronica Cappi**, Via Gorizia, 14/B, 23100, Sondrio, Tel: 0342-210459, Fax: 0342-210459 / **Eurotecnica Di Ronchi**, Via Milano 74/B, 25126, Brescia, Tel: 030-317673, Fax: 030-317673 / **Microcentro**, Via Falloppio 11, 20110, Milano, Tel: 02-26827306, Fax: 02-2826711 / **Morini Daniele**, Via Maiocchi, 10, 27058, Voghera (PV), Tel: 0383-368740, Fax: 0383-368740 / **Prada Cesare M.Antonio**, Via Riviera 142, 27100, Pavia, Tel: 0382-525920, Fax: 0382-525920 / **S.A.R.E.L. Snc Di Giglia Mario**, Carso 30, 27029, Vigevano (Pv), Tel: 0381-344088, Fax: 0381-344088 / **S.T.A.R.T. Video Hi-Fi**, Via Orti Romani 16/A, 26100, Cremona, Tel: 0372-38731, Fax: 0372-38731 / **Salvadori Claudio**, Via Del Bosco 44, 21052, Busto Arsizio (Va), Tel: 0331-329973, Fax: 0331-628727 / **Service Tva Snc**, Via Vergnano 59, 25127, Brescia, Tel: 030-349885, Fax: 030-349885 / **Tecnovideo Snc**, P.Zza De Gasperi 28, 46100, Mantova, Tel: 0376-321554, Fax: 0376-321554 / **Teletecnica 2000**, Via Torino 21, 21013, Gallarate (Va), Tel: 0331-775519, Fax: 0331-775519 / **Test Tv Snc**, Via S. Altamura 10, 20148, Milano, Tel: 02-4035408, Fax: 02-48704889 / **Video Service Snc**, Via Locatelli 2, 24068, Seriate (Bg), Tel: 035-296883, Fax: 035-300076 / **C.A.T. Snc**, Via A. Cecchi 25, 61100, Pesaro, Tel: 0721-25608, Fax: 0721-25608 / **Digitecnica Di Moroni R. Snc**, Via Zuccarini, 1-Z.Baraccola, 60131, Candia (An), Tel: 071-2866067, Fax: 071-8046398 / **Marconi Lanfranco**, Via M.Bianco 10-Porto D'ascoli, 63039, S.Bened. D/Tronto, Tel: 0735-659230, Fax: 0735-751155 / **Pluritecnica**, Via C. Ulpiani 5, 63100, Ascoli Piceno, Tel: 0736-342635, Fax: 0736-346405 / **S.A.T. Radio Tv**, Via D. Rossi 32-34, 62100, Macerata, Tel: 0733-231304, Fax: 0733-231304 / **Vitali Claudio**, Via Marconi 89, 60035, Jesi (An), Tel: 0731-59290, Fax: 0731-59290 / **Pesce Luigi**, Via Tiberio 74, 86100, Campobasso, Tel: 0874-63717 / **Alpi Lab**, Via S. Grandis 11, 12100, Cuneo, Tel: 0171-690384, Fax: 0171-690384 / **Arte E Tecnica Snc**, Via Falletti 22, 13900, Biella, Tel: 015-8496250, Fax: 015-8496250 / **Elektro Di Fiore F.**, Via Tripoli 91, 13100, Vercelli, Tel: 0161-250071, Fax: 0161-255843 / **F.G. Elektronica**, Via Sagra S.Michele 46, 10141, Torino, Tel: 011-796423, Fax: 011-796423 / **Guida Di Guida Alessio**, Via Roggiolo 5, 28069, Trecate (No), Tel: 0321-71608, Fax: 0321-777003 / **Mantoan Dario**, Via Matteotti 69, 28062, Cameri (No), Tel: 0321-519078, Fax: 0321-519078 / **Siragusa E Roagna Sdf**, C.So Matteotti 41, 14100, Asti, Tel: 0141-531131, Fax: 0141-531131 / **Videotext**, P.Zza D.Alp.Cuneense 24, 12043, Canale (Cn), Tel: 0173-95878, Fax: 0173-979638 / **A.V.S. Snc**, Via N.Pompilio 61, 72100, Brindisi, Tel: 0831-560165, Fax: 0831-560165 / **Arnesano Faustino**, Via M.Moscardino 10, 73100, Lecce, Tel: 0832-318277, Fax: 0832-318277 / **C.Ass.Tec. Di Columella**, Via Mazzini 30, 71016, San Severo (Fg), Tel: 0882-226295, Fax: 0882-226295 / **Eletr.Serv. Di Maruccio**, C.So Annibale 15/17, 74100, Taranto, Tel: 099-7721933, Fax: 099-7721933 / **Eltec Service Di Pepe G.**, Viale Ofanto 149-151, 71100, Foggia, Tel: 0881-685013, Fax: 0881-687041 / **Ingresso Fernando**, Via Biasco 15, 73100, Lecce, Tel: 0832-396466, Fax: 0832-392014 / **Marinelli Benedetto**, Via Dei Salici 14, 70051, Barletta (Ba), Tel: 0883-514054, Fax: 0883-527128 / **Massariello Agostino**, Via Numa Pompilio 65, 72100, Brindisi, Tel: 0831-521821 / **Stear Snc Di Pici**, Via E.Perrone 16, 71100, Foggia, Tel: 0881-778483, Fax: 0881-778483 / **Video Serv. Marcantonio**,

• SERVICE NIEDERLASSUNGEN • ADDRESSES D'ENTRETIEN • ONDERHOUDSADRESSEN • DIRECCIONES DE SERVICIO • INDIRIZZI DI SERVIZIO •

Via G.M. Giovene 47, 70124, Bari, Tel: 080-5618029, Fax: 080-5618029 / **Zetaclima Di Zumpano**, Via Molfetta 69, 70054, Giovinazzo (Ba), Tel: 080-3947952, Fax: 080-3947952 / **Sat Di Partipilo**, Via Borsellino E Falcone 17 Bis, 70100, Bari, Tel: 080-5022999, Fax: 080-5022992 / **Base Elettronica**, Via G. Curreli, S.N., 09170, Oristano, Tel: 0783-310049, Fax: 0783-212081 / **Chip Elettronica S.R.L.**, Via Salvator Rosa 26, 09100, Cagliari, Tel: 070-521338, Fax: 070-506074 / **Co.Ri.Fr.El. 2 Snc**, Via Del Castagno Settore D, 07026, Olbia - Zona Cerasarda

Co.Ri.Fr.El. Snc, Via Monastir 112, 09122, Cagliari, Tel: 0789-562104, Fax: 0789-9562105 / **Floris Sergio**, Via Mazzini 56, 09010, Gonnese (Ca), Tel: 0781-45436, Fax: 0781-469198 / **G.S. Elettronica**, Via Della Resistenza 5, 08100, Nuoro, Tel: 0784-203084, Fax: 0784-203060 / **Hi-Fi Center**, Via Lucania 15, 07026, Olbia (Ss), Tel: 0789-22164, Fax: 0789-200366 / **Matta Paolo**, Via Risorgimento 166/A, 09134, Cagliari-Pirri, Tel: 070-520856, Fax: 070-524148 / **Videoelettronica Snc**, Via Torino 18, 07100, Sassari, Tel: 079-276616, Fax: 079-273239 / **A.T.El. Di G.Amico**, L.Go Scarlati 30, 93100, Caltanissetta, Tel: 0934-591955, Fax: 0934-552999 / **A.V.S.**, Via Sassari, 2/C, 95100, Catania, Tel: 095-446696, Fax: 095-434337 / **Alamia Service**, C.So Pisani, 310/312, 90129, Palermo, Tel: 091-6570502, Fax: 091-6575761 / **Euroservice 2000 (Ex Aloisi)**, Via Marettimo 36, 91025, Marsala (Tp), Tel: 0923-713459, Fax: 0923-718592 / **Arte Tv E C. Snc**, Via G.Centorbi 17, 91026, Mazara Del Vallo, Tel: 0923-908160, Fax: 0923-670035 / **Centro Ass. Tec. Di Bacchi I.**, P.Za A. Giglia 40, 92026, Favara (Ag), Tel: 0922-420311, Fax: 0922-421545 / **Cuppari Electr.**, Via S.Agostino Is 265, 98100, Messina, Tel: 090-672064, Fax: 090-672065 / **Di Fonzo F.E Figli Snc**, Via Ruggero Loria 4/6, 90100, Palermo, Tel: 091-363578, Fax: 091-362853 / **Elettronica Di Di Tullio**, Via Carlentini 40/A, 96100, Siracusa, Tel: 0931-758602, Fax: 0931-758602 / **Tecnica Sud S.N.C.**, V.Le Regina Elena 225/227, 98100, Messina, Tel: 090-40037, Fax: 090-52831 / **Tecnico Siracusana**, V.P.Novelli 71, 96100, Siracusa, Tel: 0931-39440, Fax: 0931-36294 / **Torrisi Michele**, Via Novara 45, 95128, Catania, Tel: 095-445561, Fax: 095-448628 / **Vullo Michele**, Via Gorizia 16, 93100, Caltanissetta, Tel: 0934-551367, Fax: 0934-551367 / **A.T.E.S. Di Zappia L.**, Via Torino 3/A, 57124, Livorno, Tel: 0586-859566, Fax: 0586-859565 / **Belcari Nolberto**, Via J. Gagarin 70, 56012, Pisa, Tel: 0587-420273, Fax: 0587-420273 / **Centi Franco**, Va Bronzino 19/21-R, 50142, Firenze, Tel: 055-710388, Fax: 055-710388 / **Cre Carradori Snc**, Via Dei Macelli 1, 51100, Pistoia, Tel: 0573-28284, Fax: 0573-32413 / **D'amicis Gennaro**, Via P.Pisana 71, 57100, Livorno, Tel: 0586-400564, Fax: 0586-409724 / **Elettronica Rnp**, Via Romana 731, 55100, Lucca, Tel: 0583-956225, Fax: 0583-956225 / **Goti Arcangelo**, Via Magellano 42/A, 52100, Arezzo, Tel: 0575-900819, Fax: 0575-900819 / **Lab.Riparaz. Falchi M.**, Via A. Garibaldi 22-D, 57025, Piombino (Li), Tel: 0565-49400, Fax: 0565-227161 / **Lab.Tv Arrighi**, Via F.Li Cervi 26/28, 50057, P.A Elsa Empoli(Fi), Tel: 0571-931327, Fax: 571931327 / **M2 Elettronica**, Via Danimarca 3, 58100, Grosseto, Tel: 0564-454571, Fax: 0564-454571 / **Na.To.Ma Snc**, Via Del Sabotino 13, 58100, Grosseto, Tel: 0564-456229, Fax: 0564-456229 / **Pa.Ri.El.S.**, Via B. Tolomei 9, 53100, Siena, Tel: 0577-51159, Fax: 0577-589454 / **Saec Di Coppa**, Via Degli Artigiani 36, 54100, Massa, Tel: 0585-251724, Fax: 585791177 / **Tele Service Di Benvenuti**, Via F. Busoni 3/B, 50018, Scandicci, Tel: 055-753974, Fax: 055-7350267 / **Videoservice Di Genuardi**, Via Borgaccio 72, 53036, Poggibonsi (Si), Tel: 0577-983181, Fax: 0577-996382 / **Bardazzi Paolo**, Via Forlanini 8dr, 500127, Firenze, Tel: 055-4376776, Fax: 055-431956 / **Dal Pozzo Enzo**, Via Barletta 8, 39100, Bolzano, Tel: 0471-913290, Fax: 0471-913290 / **Melone Giuseppe**, Via Zara 44, 38100, Trento, Tel: 0461-235166, Fax: 0461-267210 / **Sighel Mauro**, Via A. Volta 92, 38100, Trento, Tel: 0461-935919, Fax: 0461-935919 / **Tecnoservice Snc**, Via San Vigilio 64/B-C-D, 39100, Bolzano, Tel: 0471-289062, Fax: 0471-261559 / **Quondam C. Stefano**, Via Del Rivo 33, 05100, Terni, Tel: 0744-301512, Fax: 0744-301512 / **Tecnoconsult Elettr.**, Via Madonna Alta 185, 06100, Perugia, Tel: 075-5003089, Fax: 075-5003089 / **C.A.T. Di D'isanto**, C.So Ivrea 82/A, 11100, Aosta, Tel: 0165-364056, Fax: 0165-235910 / **Ass.Eletr.Campi Snc**, Via E.Reginato 87, 31100, Treviso, Tel: 0422-436245, Fax: 0422-435996 / **D.D. Assistenza Tecnica**, Via Mondin 11, 32100, Belluno, Tel: 0437-30240, Fax: 0437-939916 / **DI Service Di Dal Lago**, Via Giaretta 33, 36100, Vicenza, Tel: 0444-566662, Fax: 0444-966239 / **G.F.L. S.R.L.**, Via D. De Massari 10, 37045, Legnago, Tel: 0442-602020, Fax: 0442-602021 / **L'elettronica Piu' Snc**, Via Gaspere Campo 18, 45100, Rovigo, Tel: 0425-33221, Fax: 0425-33221 / **Pieffe Di Premier F.**, Via Zermanese 6/B, 31100, Treviso, Tel: 0422-321054, Fax: 0422-321054 / **Pierezza Carlo**, Via Barroccio Dal Borgo 4, 35100, Padova, Tel: 049-8643266, Fax: 049-8643266 / **Sat Di Galber E C. Snc**, Via Catarinetti 1/E, 37136, Verona, Tel: 045-509609, Fax: 045-509699 / **Speedy Service**, Viale Europa 42/B, 36016, Thiene Vi, Tel: 0445-368235, Fax: 0445-379028 / **Tecno Futura Di Rossi**, Via Delfinato 8 (Laboratorio), 35127, Camin (Pd), Tel: 049-9129469, Fax: 049-9126147 / **Video Service**, Via Vitruvio 11, 37100, Verona, Tel: 045-566299, Fax: 045-573865 / **Video Tv 17323**, Via S. Marco 1818, 30019, Sittomarina (Ve), Tel: 041-5541675, Fax: 041-5541675 / **Vignando Luigino**, Via Dell'industria 18, 30020, Gruaro (Ve), Tel: 0421-74472, Fax: 0421-72923 / **Zaffalon Urbano**, Cas.Calle Corraz. 3849, 30122, Venezia, Tel: 041-2750670, Fax: 041-2757273

ESPAÑA

En caso de una reclamación con vuestra SHARP Microwave, preguntan por favor la casa dónde han comprado su máquina o infórmanse en una de las SHARP Service casas siguientes.

Merino Nicolas Jose A., - 945/ 25.18.92 - Av Judizmendi 24, 01003 Vitoria-Gasteiz, Alava / **Tele-Color** - 96/585.24.60, Cl Del Vent 9, 03500 Benidorm, Alicante / **Telecom Electronica** - 96/539.50.21, Cl Hernan Cortes 8, 03600 Elda, Alicante / **Eurosat, S.L.** - 96/525.80.40, Cl Montero Rios 33 03013 Alicante / **Electronica Gomez** - 96/ 546.75.81, Cl Baltasar Tristany 100, 03201 Elche, Alicante / **Angel Avellan Puig** - 965/ 21.32.55, Cl Poeta Quintana 13, 03004 Alicante / **Electronica Eler** - 965/ 25.63.32, Cl Pinoso 8, 03012 Alicante / **Insat**, Cb - 971/ 36.53.18, Cl Pintor Calbo 30, 07703 Mahon, Baleares (Menorca) / **Reparaciones Ortega** - 971/ 39.01.55, Cl Via Punica 33, 07800 Ibiza, Baleares (Ibiza). / **Audio Imagen** - 971/ 31.46.59, Cl Jose Riquer Llobet 8, 07800 Ibiza, Baleares (Ibiza) / **Irtesa Electronica** - 971/ 20.47.02, Cl Jaume Ferran 72 Bjos, 07004 Palma De Mallorca, Baleares (Mallorca) / **Instalaciones Maes**, S.L - 971/ 27.49.47, Cl Son Nadal 63, 07008 Palma De Mallorca, Baleares (Mallorca) / **Electron.** **Pons Gomila Sa** - 971/ 37.22.76, Cr Nueva 162, 07730 Alayor, Baleares (Menorca) / **Jose Marques Anglada,S.L.** - 971/ 38.54.54, Cl Lepanto 19, 07760 Ciudadela, Baleares (Menorca) / **Anoia Electrovisio** - 93/ 805.11.90, Av Balmes 12, 08700 Igualada, Barcelona / **Audio Vision** - 385.78.08, Cl Mare Deu Montserrat 22, 08922 Sta.Coloma, Barcelona / **Sac-2, S.C.P.** - 331.77.54, Cl Riera Blanca 113, 08028 Barcelona / **Fermo** - 465.22.00, Av Morera 5, 08915 Badalona / **Elec.Safont** - 821.30.03, Cl Gral. Manso Sola 31, 08600 Berga, Barcelona / **Servinters, S.C.C.L.** - 389.44.60 - Pz Casagemes 20, 08911 Badalona / **Tecnik's, S.C.P.** - 630.11.20, Cl Joan Bardina 32, 08830 Sant Boi De Ll, Barcelona / **Ce. Va. Sat, S.C.** - 785.51.11, Cr Matadepera 87, 08225 Terrassa, Barcelona / **Laurea S.A.T.** - 889.02.48, Cl Guilleries Bis 20, 08500 Vic, Barcelona / **Ce. Va. Sat, S.C.** - 710.76.13, Ps Rubio I Ors 105, 08203 Sabadell, Barcelona / **Villaret Polo Ramon** - 798.02.48, Cl Moli De Vent 21, 08303 Mataro, Barcelona / **Estarlich Pradas Vicente** - 766.22.33, Cl Industria 131, 08370 Calella, Barcelona / **Videocolor** - 93/ 454.99.08, Cl Villarroel 44, 08011 Barcelona / **Elde** - 872.85.42, Cl Bruch 55, 08240 Manresa, Barcelona / **Pulgar I Edo S.L.** - 93/ 436.44.11, Cl Castillejos 333, 08025 Barcelona / **Electronica Mateos** - 849.28.77, Cr De Caldas (Bajos) 76, 08400 Granollers, Barcelona / **Antonio Robles**

• SERVICE NIEDERLASSUNGEN • ADDRESSES D'ENTRETIEN • ONDERHOUDSADRESSEN • DIRECCIONES DE SERVICIO • INDIRIZZI DI SERVIZIO •

Sanchez - 872.55.41, Cl Sant Bartomeu 42, 08240 Manresa, Barcelona / **Top Electronica**, 890.35.91, Cl Misser Rufet 4 Bjos, 08720 Vilafranca Penedes, Barcelona / **La Clínica Del Electro**, 93/ 236.44.11, Cl Balmes 160, 08008 Barcelona / **Fix Servicio Tecnico**, 675.59.02, Cl Sant Ramon 3 L-2, 08190 Sant Cugat Valles, Barcelona / **Sonitec Electronica**, C.B., 815.74.44, Cl Aigua 143, 08800 Vilanova I Geltru, Barcelona / **Totvisio Electronica S.L.**, 873.88.81, Pj Ferrer 14, 08240 Manresa, Barcelona / **4 En 1 Reparaciones**, 430.97.2, Cl Taquigrafo Marti 19, 08028 Barcelona / **Movilfrit S.A.**, 93/ 630.14.53, Cl Osca 11-C Pol.Salinas, 08830 Sant Boi De Ll., Barcelona / **Tele-Servei Bruc S.L.**, 93/ 207.08.08, Cl Rossello 289, 08037 Barcelona / **Sabe Electronica**, 964/ 21.52.65, Cl Joaquin Costa 46, 12004 Castellon / **F.Carceller-F.Cervera,C.B.**, 964/ 45.44.65, Cl Carrero 29, 12500 Vinaros, Castellon / **Asiste, S.L.**, 964/ 21.57.69, Av De Valencia Nave 19, 12006 Castellon / **Technotronic**, 971/ 32.27.62, Cl Ibiza 12, 07860 San Fco. Javier, Formentera / **Reparaciones Pilsa S.C.**, 972/ 20.66.96, Cl J. Pascual I Prats 8, 17004 Gerona / **Satel**, 972/ 26.55.19, Ps De Barcelona 12, 17800 Olot, Girona / **Salleras Puig Juan**, 972/ 50.67.54, Cl Pou Artesia 4, 17600 Figueres, Girona / **Riera Daviu**, 972/ 50.32.64, Cl Torras Y Bages 19, 17600 Figueres, Girona / **Lavison, C.B.**, 972/ 23.01.22, Cl Montseny 35, 17005 Girona / **Monje Ure#A Manuel**, 972/ 70.25.52, Cl Sant Quinti 33, 17534 Ribes De Freser, Girona / **Estudios 3**, C.B., 943/ 45.37.97, Pz De Los Estudios 3, 20011 San Sebastian, Guipuzcoa / **Teknibat Electronica**, 943/ 70.24.37, Cl Zezenbide 4, 20600 Eibar, Guipuzcoa / **Reparaciones Urruti S.L.**, 943/ 45.84.10, Ps Aintzieta 32, 20014 San Sebastian, Guipuzcoa / **Teleservic**, 974/ 31.34.44, Cl Estadilla 6, 22300 Barbastro, Huesca / **Servelectro**, 974/ 21.00.14, Cl Baltasar Gracian 5, 22002 Huesca / **Telesonic**, 974/ 36.32.97, Cl Teruel 6, 22700 Jaca, Huesca / **Teleservicio**, 974/ 22.01.39, Cl Tenerias 20, 22001 Huesca / **Satef**, 973/ 50.08.48, Av Raval Del Carme 12, 25300 Tarrega, Lerida / **Ielsa, C.B.**, 973/ 24.71.27, Cl Tarragona 40, 25005 Lleida / **Cristel**, 973/ 27.08.26, Cl Vallcalent 32, 25006 Lleida / **Unitec**, 948/ 82.74.34, Cl Fuente Canonigos 5, 31500 Tudela, Navarra / **Telsan, C.B.**, 948/ 24.19.50, Cl Gayarre 1 Bjos., 31005 Pamplona, Navarra / **Euro Tecnicos Electronica**, 977/ 32.24.89, Cl Lepanto 16-18, 43202 Reus, Tarragona / **Electro Servei C.B.**, 977/ 51.04.42, Ps Moreira 10, 43500 Tortosa, Tarragona / **A.B.R. Electronica S.L.**, 977/ 50.21.20, Cl Calderon La Barca 3, 43520 Roquetes, Tarragona / **Curto Gamundi S.R.C.**, 977/ 44.13.14, Cl Rierol Caputxins 6, 43500 Tortosa, Tarragona / **Selecco S.L.**, 977/ 70.00.12, Cl Calderon De La Barca 11, 43870 Amposta, Tarragona / **Electronica S. Torres**, 977/ 21.21.48, Cl Joan Miro 4 Esc.D 1-2, 43005 Tarragona / **Buira Tecnic's**, 977/ 66.04.37, Cl San Javier 55, 43700 El Vendrell, Tarragona / **Tecno Serveis Mora**, 977/ 40.08.83, Cl Pau Picaso 1, 43740 Mora D'ebre, Tarragona / **Sertecs, S.C.**, 977/ 22.18.51, Cl Caputxins (Bajos) 22, 43001 Tarragona / **Electronica Josep**, 977/ 88.04.41, Ctra. Igualada 29 Bjos, 43420 Sta. Coloma Queralt, Tarragona / **Martorell Altes**, 977/ 75.32.41, Cl Roseta Mauri 10, 43205 Reus, Tarragona / **Teleservicio S.C.**, 978/ 87.08.10, Cl Romualdo Soler 4, 44600 Alcañiz, Teruel / **Electronica Alcañiz S.L.**, 979/ 87.07.94, Cl Carmen 21, 44600 Alcañiz, Teruel / **Sonovision, C.B.**, 978/ 60.11.74, Cl Abadia 5, 44001 Teruel / **Electronica Moncho**, 96/287.23.29, Cl Pare Pascual Cat. 5, 46700 Gandia, Valencia / **Envisa Electronic, S.L.**, 96/241.24.87, Cl General Espartero 9, 46600 Alzira, Valencia / **Antonio Monleon, S.L.**, 96/334.55.87, Av De La Plata 91, 46006 Valencia / **Tecno Hogar**, 96/286.53.35, Cl Dos De Mayo 41, 46700 Gandia, Valencia / **Servicios Electronicos**, 96/340.20.34, Cl Doctor Oloriz 3, 46009 Valencia / **Electronica Las Heras**, 96/ 238.11.14, Cl Jose Iranzo 6, 46870 Ontinyent, Valencia / **Negredo Martin Daniel**, 94/411.22.82, Cl Padre Pernet 8, 48004 Bilbao, Vizcaya / **Collantes Martin Onofre**, 94/ 483.21.22, Cl Ortuño De Alango 7, 48920 Portugalete, Vizcaya / **Argi Giltz**, 94/ 443.77.93, Cl Autonomia 15, 48012 Bilbao, Vizcaya / **Servitele**, 94/444.89.02, Cl Autonomia 24 Galerias, 48012 Bilbao, Vizcaya / **Cinca Monterde Antonio**, 976/ 31.69.65, Cl Via Universitat 52, 50010 Zaragoza / **Aragon Televideo, S.C.**, 976/ 32.97.12, Cl Batalla Clavijo 18, 50010 Zaragoza / **Tv Video Jimenez, S.L.**, 967/ 34.04.43, Cl Juan XXIII 38, 02640 Almansa, Albacete / **Juman**, 967/ 22.40.78, Cl Ejercito 1, 02002 Albacete / **Televideo**, 950/ 40.18.63, Cl Velazquez 7 Local-A, 04770 Adra, Almeria / **Servicio Tecnico Ponce**, 950/ 45.67.53, Ub Monte Almagro 10, 04610 Cuevas De Almanzora, Almeria / **Sonivitel S.L.**, 950/ 22.97.55, Cl Poeta Paco Aquino 51, 04005 Almeria / **Electronica Edimar**, S.A, 98/535.34.51, Cl Cangas De Onis 4, 33207 Gijon, Asturias / **Cañedo S.T.**, 98/522.29.68, Cl Otero, S/N C. Cial, 33008 Oviedo, Asturias / **Alvarez Olivar Casilda**, 98/522.37.39, Cl San Jose 12, 33003 Oviedo, Asturias / **Santiago Valderrey**, 98/ 563.18.61, Cl Dr. Venancio Mtez. 7, 33710 Navia, Asturias / **Astusetel S.L.**, 98/539.10.11, Cl Cea Bermudez 9, 33208 Gijon, Asturias / **Asturservice**, 98/556.83.87, Cl Sanchez Calvo 6 Bjos., 33401 Aviles, Asturias / **Juan Morillon Del Corro**, 98/567.40.24, Av De Gijon 19, 33930 La Felguera/Langreo, Asturias / **S.A.T. Juan-Manuel**, 98/ 581.22.48, Cl Uria 60, 33800 Cangas De Narcea, Asturias / **Daniel Serrano Labrado**, 920/ 37.15.16, Cl Jose Gochicua 16, 05400 Arenas De S.Pedro, Avila / **Electronica Gredos**, 920/ 22.48.39, Cl Eduardo Marquina 24, 05001 Avila / **Jimenez Almohalla**, 920/ 25.08.76, Cl Jacinto Benavente 1, 05001 Avila / **Electronica Bote**, 924/ 22.17.40, Pz Portugal 2, 06001 Badajoz / **Marcial Lagoa Gonzalez**, 924/ 49.03.33, Cl Ramon Y Cajal 7, 06100 Olivenza, Badajoz / **C.E. Vilanovense C.B.**, 924/ 84.59.92, Cl Camino Magacela 4 Local-5, 06700 Villanueva Serena, Badajoz / **Electronica Centeno S.L.**, 924/ 57.53.08, Av Del Zafra 1, 06310 Puebla Sancho Perez, Badajoz / **Indalecio Amaya Sanchez**, 924/ 66.47.01, Cl Carreras 11, 06200 Almendralejo, Badajoz / **Patricio Electronica**, 924/ 33.04.13, Cl Reyes Huertas 7, 06800 Merida, Badajoz / **Electronica Mas**, 947/ 31.49.94, Cl Alfonso Vi 6, 09200 Miranda De Ebro, Burgos / **Servitec Burgos S.L.**, 947/ 22.41.68, Cl Lavaderos 7-9, 09007 Burgos, Burgos / **Ruiz Garcia Jose**, 927/ 22.48.86, Cl Ecuador 5-B, 10005 Caceres / **Arsenio Sanchez**, C.B., 927/ 41.11.21, Cl Tornavacas 9, 10600 Plasencia, Caceres / **Zabala Vazquez Jose**, 927/ 57.06.13, Cl Del Agua 39, 10460 Losar De La Vera, Caceres / **Radio Sanchez C.B.**, 927/ 32.06.88, Av De Miajadas S/N, 10200 Trujillo, Caceres / **Electronica Jeda**, Cl Pagador 31, 11500 Pto. Sta. Maria, Cadiz / **Servicio Tecnico**, 956/ 87.07.05, Cl Divina Pastora E-1 L-4, 11402 Jerez La Frontera, Cadiz / **Jose Borja Y Jose Arana**, 956/ 66.60.53, Cl San Antonio 31, 11201 Algeciras, Cadiz / **Vhifitel**, 956/ 46.25.01, Cl Fco.Fdez.Ordoñez 5, 11600 Ubrique, Cadiz / **Galan Sat S.L.**, 956/ 20.14.17, Cl Cruz Roja Española 11, 11009 Cadiz / **Galan Sat S.L.**, 956/ 83.35.35, Cl Factoria Matagorda 52, 11500 Puerto Real, Cadiz / **Electronica Seyma**, 942/ 23.69.19, Cl Del Monte 69 C Bjos, 39006 Santander, Cantabria / **Tele-Nueva**, 926/ 50.59.96, Cl Campo 56, 13700 Tomelloso, Ciudad Real / **Electronica Arellano**, 926/ 54.78.95, Cl Lorenzo Rivas 14, 13600 Alcazar De San Juan, Ciudad Real / **Electronica Lara**, 926/ 21.17.87, Cl De La Jara 1, 13002 Ciudad Real / **Manuel Vazquez**, 926/ 42.09.93, Cl Aduana 3, 13500 Puertollano, Ciudad Real / **Electrodiaz S.L.**, 926/ 32.23.24, Cl Buensuceso 10, 13300 Valdepeñas, Ciudad Real / **DuelAs CalAs Teodoro**, 957/ 26.35.06, Cl Hermano Juan Fdez 15, 14014 Cordoba / **Electronica Sales**, 957/ 66.09.04, Cl Andalucia 11, 14920 Aguilar Frontera, Cordoba / **Lavison Electronica S.L.**, 957/ 75.01.75, Cm De La Barca 3, 14010 Cordoba / **Antonio Gonzalez**, 957/ 57.10.50, Cl Giral Primo Rivera 61, 14200 Peñarroya, Cordoba / **Electronica Garcia**, 969/ 22.24.83, Cl Ramon Y Cajal 17, 16004 Cuenca / **Gallardo Alonso Miguel**, 958/ 67.64.81, Cl Carmen 104, 18510 Benalua De Guadix, Granada / **Vilchez Vilchez Rafael**, 958/ 60.06.50, Cl Amadeo Vives 9, 18600 Motril, Granada / **Electronica Wenceslao**, 958/ 81.16.16, Cl Fontiveros 42, 18008 Granada, Granada / **Digitat Electronica**, 958/ 70.04.52, Cl Casicas 7, 18800 Baza, Granada / **Megatecnica Extremeira**, 958/ 26.06.01, C./Mozart L-2 Ed.Granate, 18004 Granada, Granada / **Tecnicas Marvi S.L.**, 949/ 23.27.63, Pz Capitan Boixareu 51, 19001 Guadalajara / **Abril Sanchez Valentin**, 959/ 10.60.41, Cl Cadiz 2, 21270 Cala, Huelva / **Telesonid Huelva, S.C.A.**, 959/ 24.38.60, Cl

· SERVICE NIEDERLASSUNGEN · ADDRESSES D'ENTRETIEN · ONDERHOUDSADRESSEN · DIRECCIONES DE SERVICIO · INDIRIZZI DI SERVIZIO ·

Fco.Vazquez Limon 4, 21002 Huelva / **Electronica Sur**, 959/ 47.11.51, Cl M. Lerdo De Tejada 9, 21400 Ayamonte, Huelva / **Electro Himega, S.A.**, 953/ 24.22.56, Cl Adarves Bajos 4-C, 23001 Jaen / **Electronica Jumar**, 953/ 26.17.08, Cl Goya (Las Flores) 1, 23006 Jaen / **Electronica Gonzalez**, 953/ 50.33.82, Corredera San Bartolome 11, 23740 Andujar, Jaen / **Uniservic Electronica**, 953/ 75.14.19, Cl Goya 1 Bjos, 23400 Ubeda, Jaen / **Anuma**, 953/ 69.70.41, Cl Paredon 24, 23700 Linares, Jaen / **Talleres Instaluz**, 981/ 26.80.26, Cl Juan Florez 110, 15005 La Coruña / **Garcia Quintela Arturo**, 981/ 70.21.07, Cl Xoane, 15100 Carballo, La Coruña / **Manuel Mato Señaris**, 981/ 53.71.14, Cl Silvouta-Pedra Da, 15896 Santiago Compostela, La Coruña / **Zener Electronica**, 981/ 22.07.00, Cl Ronda De Monte Alto 15, 15002 La Coruña / **S.T. Mendez**, 981/ 27.52.52, Cl Gil Vicente 13, 15011 La Coruña / **Electronica Castilla**, 981/ 32.14.09, Cr Castilla 377-Bis Bjos, 15404 Ferrol, La Coruña / **Bandin Audio**, 981/ 86.60.23, Cl Rua Arcos Moldes 2 B-3, 15920 Rianxo, La Coruña / **Electronica Torres, S.C.**, 941/ 24.76.15, Av Navarra 14, 26001 Logroño, La Rioja / **Top Service**, 941/ 13.50.35, Cl Achutegui De Blas 17, 26500 Calahorra, La Rioja / **Aguado Gil Roberto**, 941/ 25.25.53, Av Viana 10, 26001 Logroño, La Rioja / **Telson**, 987/ 21.25.18, Cl Batalla Clavijo 2, 24006 Leon / **Salvador Rodriguez, C.B.**, 987/ 40.36.02, Cl Ortega Y Gasset 24, 24400 Ponferrada, Leon / **Prosat**, 987/ 20.34.10, Pz Doce Martires 5, 24004 Leon / **Electronica Fouces**, 982/ 40.24.38, Cl Benito Vicetto 34, 27400 Monforte De Lemos, Lugo / **Televexo S.L.**, 982/ 58.18.57, Cl Nosa Sra. Do Carmen 82, 27880 Burela, Lugo / **Electronica Penelo**, 982/ 21.47.43, Cl Serra Ga#ldoira 63, 27004 Lugo / **Gomescan**, 91/305.48.90, Pz Del Jubilado 8, 28042 Barajas-Madrid, Madrid / **Electronica Garman, C.B.**, 91/368.01.79, Cl Mandarina 15, 28027 Madrid / **Electronica Ansar**, 91/ 460.47.45, Cl Tomasa Ruiz 4, 28019 Madrid / **Tec-Norte**, 91/851.63.47, Cl Santiago Apostol 12, 28400 Collado Villalba, Madrid / **Variosat, S.L.**, 91/662.04.68, Cl Isla De Corcega 24, 28100 Alcobendas, Madrid / **Elbeservi, S.A.**, 91/386.27.11, Cl Dr.R. Castroviejo 19, 28029 Madrid / **Alcala Servitec C.B.**, 91/889.00.32, Cl Santa Ursula 5, 28801 Alcala De Henares, Madrid / **Garman C.B.**, Cl Carlos Sole 38 Local, 28038 Madrid / **Aviles Sanchez Antonio**, 952/ 36.16.02, Cl Ciudad De Andujar 2, 29006 Malaga / **Video Taller, S.C.**, 952/ 54.23.95, Edif. La Noria B Bjos-5, 29740 Torre Del Mar, Malaga / **Servisuel, Edif. La Union**, 952/ 46.90.28, Cm De Las Ca#Adas Lc 2, 29640 Fuengirola, Malaga / **Biser, S.L.**, 952/ 25.55.53, Cl Lozano De Torres 8, 29013 Malaga / **Electro Ronda**, 952/ 87.59.99, Cl Santa Cecilia 11, 29400 Ronda, Malaga / **Diego Lopez Jodar**, 95/ 280.12.23, Pz Del Reloj 13, 29680 Estepona, Malaga / **Caro Porlan Raimundo**, 968/ 46.18.11, Cl Jose Maulica 45, 30800 Lorca, Murcia / **Reg., C.B.**, 968/ 51.00.06, Cl Antonio Oliver 17, 30204 Cartagena, Murcia / **Electroservicios Seba, C.B.**, 968/ 29.85.93, Cl Isaac Albeniz 4 Bjos, 30009 Murcia / **Visatel**, 968/24.16.47, Cl Torre Alvarez S/N, 30007 Murcia / **Electro Servicios Plaza**, 968/ 28.45.67, Cl Gomez Cortina 10, 30005 Murcia / **Rafael Gomez Yelo**, 968/ 26.14.67, Ps Corbera 17, 30002 Murcia / **Fernandez Gonzalez Jose**, 988/ 23.48.53, Av Buenos Aires 75 Bjos, 32004 Orense / **Electronica Javier**, 979/ 75.03.74, Cl Ramirez 5, 34005 Palencia / **Central De Servicios**, 986/ 37.47.45, Cl Asturias (Bajo) 10, 36206 Vigo, Pontevedra / **Montajes Servicios Tecn.**, 986/ 84.16.36, Cl Loureiro Crespo 43, 36004 Pontevedra / **Sial-Alvimo S.L.**, 986/ 29.93.01, C/ C.Torrecedeira 92 Bjos, 36202 Vigo, Pontevedra / **Electronica Cambados**, 986/ 50.83.27, Cl Camilo Jose Cela 13, 36600 Vilagarcia Arousa, Pontevedra / **Almat Electronica**, 923/ 22.45.08, Cl Galileo 21, 37004 Salamanca / **Guijo S.T.**, 921/ 42.94.18, Cl Ramon Y Cajal 1, 40002 Segovia / **Avitelsat, S.A.**, 954/ 66.21.52, Cl Espinosa Y Carcel 31, 41005 Sevilla / **Vanhcolor, S.L.**, 95/433.83.03, Cl San Jacinto 96, 41010 Sevilla / **Telepal**, 95/464.95.80, Cl Julio Verne 49, 41006 Sevilla / **Auvitel, S.L.**, 95/427.57.07, Cl Virgen De Africa 20, 41011 Sevilla / **Audio Color**, 95/457.94.47, Cl Golgota 3 Local-Izda., 41003 Sevilla / **Electro 93 S.L.**, 95/ 472.37.16, Cl Melliza 1, 41700 Dos Hermanas, Sevilla / **Teco**, 975/ 22.61.25, Cl Antolin De Soria 10, 42003 Soria / **Electronica Rivas**, 925/ 80.55.46, Cl Barrio San Juan 1, 45600 Talavera La Reina, Toledo / **Electronica Fe-Car, S.L.**, 925/ 21.21.45, Av Santa Barbara 30, 45006 Toledo / **Electronica Jopal S.L.**, 925/ 25.04.42, Av Santa Barbara S/N, 45006 Toledo / **Electro Anaya**, 925/ 48.09.81, Cl Vertedera Alta 14, 45700 Consuegra, Toledo / **Teleservicios**, 983/ 30.92.61, Cl Esgueva 6, 47003 Valladolid / **Asist. Tecnica Marcos**, 983/ 29.78.66, Cl Pio Del Rio Horteiga 2-4, 47014 Valladolid / **Electronica Vitelson**, 983/ 80.43.56, Pz Del Mercado 9, 47400 Medina Del Campo, Valladolid / **R.T.V. Blanco**, 980/ 51.14.41, Cl Eduardo Julian Perez 9, 49018 Zamora

SWITZERLAND

Sharp Electronics AG, Langwiesenstrasse 7, 8108 Dällikon, Tel: +41 1 846 61 11.

SWEDEN

Vid förfrågningar angående din mikrovågsugn var vänlig kontakta din återförsäljare eller någon av Sharps representanter **Centralservice Umeå**, Formvägen 8, 90621 Umeå, Phone: 090-125001, Fax: 090-131135 / **MN Elektronikservice AB**, Flygplatsinfarten 10A, 161 11 Bromma, Phone: 08-6275900, Fax: 08-6275160 / **Jönköpings Antenn & TV Service**, Fridhemsvägen 20, 553 02 Jönköping, Phone: 036-161690, Fax: 036-160211 / **Ratronik Radio & TV Service**, Nordlandergatan 15, 931 32 Skellefteå, Phone: 0910-17305, Fax: 0910-16844 / **Tomi Elektronik AB**, Bäckvägen 90, 126 47 Hägersten, Phone: 08-186170, Fax: 08-186175 / **Tretronik**, Östermovägen 33, 854 62 Sundsvall, Phone: 060-155925, Fax: 060-173690 / **TV-Trim Service AB**, S:T Pauligatan 37, 416 60 Göteborg, Phone: 031-847200, Fax: 031-847500

NORWAY

Finn Clausen AS, Postbox 274, No-0511 Oslo, Phone: 47-22635000, Fax: 47-22646655
Norsk Elektronik senter, Postbox 13, No-2007 Kjeller, Phone: +47-63804500, Fax: +47-63804501

ICELAND

Braedurnir Ormsson Ltd, PO box 8790, IS-128 Reykjavik, Phone: +354-5332800, Fax: +354-5332810
Hjoltaekni Ehf, Skeifur, IS-108 Reykjavik, Phone: +354-5332150, Fax: +354-5332151

DENMARK

Sö Höyem AS, Büllowsvej 3, DK-1870 Fredriksberg C, Phone: 45-31224434, Fax: 45-31224127
Almstock Radio & Tv service, Sallingsvej 61, DK-2720 Varløse, Phone: 45-38740021, Fax: 45-38740031

SUOMI

Oy Perkko, PL 40 Rällsintie 6, SF-00721 Helsinki, Phone: +35-8947805000, Fax: +35-8947805480
Theho Video, Kuotaankatu 7, SF-00520 Helsinki, Phone: +35-891451500, Fax: +35-891461767



SPECIFICATIONS

AC Line Voltage		: 230 V, 50 Hz, single phase
Distribution line fuse/circuit breaker		: Minimum 16 A
AC Power required:	Microwave	: 1,45 kW
	Top Grill	: 1,25 kW
	Bottom Grill	: 0,65 kW
	Top & Bottom Grill	: 1,85 kW
	Top Grill/Microwave	: 2,65 kW
	Bottom Grill/Microwave	: 2,05 kW
	Triple	: 3,40 kW
Output power:	Microwave	: 900 W (IEC 60705)
	Top Grill	: 1,2 kW
	Bottom Grill	: 0,6 kW
Microwave Frequency		: 2450 MHz
Outside Dimensions		: 520 mm (W) x 309 mm (H) x 437 mm (D)
Cavity Dimensions		: 353 mm (W) x 207 mm (H) x 357 mm (D)
Oven Capacity		: 26 litres
Turntable		: ø325 mm, metal
Weight		: approx. 17,5 kg
Oven lamp		: 25 W/240 - 250 V

This oven complies with the requirements of Directives 89/336/EEC and 73/23/EEC as amended by 93/68/EEC.

SPECIFICATIONS ARE SUBJECT TO CHANGE WITHOUT NOTICE AS PART OF CONTINUOUS IMPROVEMENT

SHARP



Das Papier dieser Bedienungsanleitung besteht zu 100 % aus Altpapier

Le papier de ce mode d'emploi est fait de 100 % de papier réutilisé

De papier voor deze gebruiksaanwijzing is van 100 % hergebruikt papier gemaakt

La carta di questo manuale d'istruzioni è fatta di 100 % della carta riciclata

El papel de este manual de instrucciones se hace de 100 % es del papel reciclado

O papel deste manual da operação é feito de 100 % do papel recycled

SHARP ELECTRONICS (EUROPE) GMBH.
Sonninstrasse 3, 20097 Hamburg
Germany

TINS-A289URRO

Gedruckt in Grossbritannien
Imprimé au Royaume-Uni
Gedruckt in Groot-Brittannie
Stampato in Gran Bretagna
Impreso en el Reino Unido
Impresso no Reino Unido



SPECIFICATION

AC Line Voltage		: 230 V, 50 Hz, single phase
Distribution line fuse/circuit breaker		: Minimum 16 A
AC Power required:	Microwave	: 1,45 kW
	Top Grill	: 1,25 kW
	Bottom Grill	: 0,65 kW
	Top & Bottom Grill	: 1,85 kW
	Top Grill/Microwave	: 2,65 kW
	Bottom Grill/Microwave	: 2,05 kW
	Triple	: 3,40 kW
Output power:	Microwave	: 900 W (IEC 60705)
	Top Grill	: 1,2 kW
	Bottom Grill	: 0,6 kW
Microwave Frequency		: 2450 MHz
Outside Dimensions		: 520 mm (W) x 309 mm (H) x 437 mm (D)
Cavity Dimensions		: 353 mm (W) x 207 mm (H) x 357 mm (D)
Oven Capacity		: 26 litres
Turntable		: ø325 mm, metal
Weight		: approx. 17,5 kg
Oven lamp		: 25 W/240 - 250 V

This oven complies with the requirements of Directives 89/336/EEC and 73/23/EEC as amended by 93/68/EEC.

SPECIFICATIONS ARE SUBJECT TO CHANGE WITHOUT NOTICE AS PART OF CONTINUOUS IMPROVEMENT

SHARP



Der Zellstoff zur Herstellung dieses Papiers kommt zu 100 % aus nachhaltig bewirtschafteten Wäldern

Ce papier est entièrement fabriqué à partir de pâte à papier provenant de forêts durables

De pulp die gebruik is voor de vervaardiging van dit papier is voor 100 % afkomstig uit bossen die doorlopend opnieuw aangepland worden

Il 100 % della pasta utilizzata per produrre questa carta proviene da foreste sostenibili

El 100 % de la pasta utilizada en la fabricación de este papel procede de bosques sostenibles

Este papel é totalmente fabricado a partir de pasta de papel proveniente de florestas duráveis

SHARP ELECTRONICS (EUROPE) GMBH.
Sonninstrasse 3, 20097 Hamburg
Germany

TINS-A289URRO

Gedruckt in Grossbritannien
Imprimé au Royaume-Uni
Gedruckt in Groot-Brittannie
Stampato in Gran Bretagna
Impreso en el Reino Unido
Impreso no Reino Unido