

ZANUSSI

Ceramic glass induction hob

ZKT 651 D

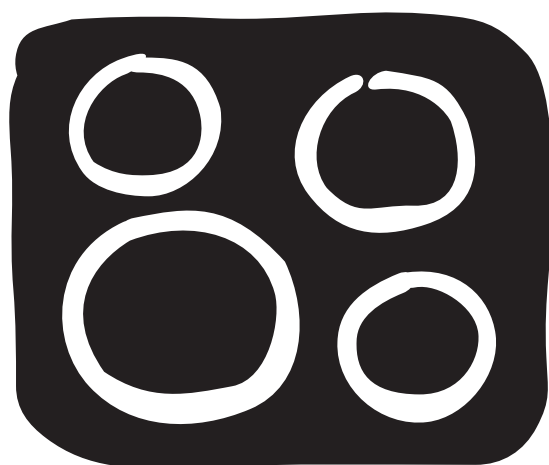

Dear Customer,

Please read these user instructions carefully and keep them to refer to later.

Please pass the user instructions on to any future owner of the appliance.

The following symbols are used in the text:



Safety instructions

Warning! Notes that concern your personal safety.

Important! Notes that show how to avoid damage to the appliance.



Useful tips and hints



Environmental information

Contents

Operating Instructions	4
Safety instructions	4
Description of the Appliance	5
Cooking surface layout	5
Control panel layout	5
Touch Control sensor fields	6
Displays	6
Residual heat indicator	6
Operating the appliance	7
Switching the appliance on and off	7
Selecting the heat setting	7
Using the automatic warm-up function	8
Locking/unlocking the control panel	9
Using the child safety device	9
Switching the power function on and off	10
Using the timer	11
Safety cut-out	13
Tips on cooking and frying	14
Cookware for induction cooking zones	14
Tips on energy saving	15
Examples of cooking applications	15
Cleaning and care	16
What to do if	17
Disposal	18
Installation Instructions	19
Assembly	21
Rating Plate	24
Warranty conditions	25
Service and Spare Parts	27

Operating Instructions

Safety instructions

 Please comply with these instructions. If you do not, any damage resulting is not covered by the warranty.

 This appliance conforms with the following EU Directives:

- 73/23/EEC dated 19.02.1973 Low Voltage Directive
- 89/336/EEC dated 03.05.1989 EMC Directive inclusive of Amending Directive 92/31/EEC
- 93/68/EEC dated 22.07.1993 CE Marking Directive

Correct use

- This appliance should be used only for normal domestic cooking and frying of food.
- The appliance must not be used as a work surface or as a storage surface.
- Additions or modifications to the appliance are not permitted.
- Do not place or store flammable liquids, highly inflammable materials or fusible objects (e.g. plastic film, plastic, aluminium) on or near the appliance.

Child safety

- Small children must be kept away from the appliance.
- Only let older children work on the appliance under supervision.

General safety

- The appliance may only be installed and connected by trained, registered service engineers, or competent persons.
- Built-in appliances may only be used after they have been built in to suitable built-in units and work surfaces that meet standards.
- In the event of faults with the appliance or damage to the glass ceramic (cracks, scratches or splits), the appliance must be switched off and disconnected from the electrical supply to prevent the possibility of an electric shock..
- Repairs to the appliance must only be carried out by trained registered service engineers.

Safety during use

- Remove stickers and film from the glass ceramic.
- There is the risk of burns from the appliance if used carelessly.
- Cables from electrical appliances must not touch the hot surface of the appliance or hot cookware.
- Overheated fat and oil can ignite quickly. When cooking with fat or oil (e.g. frying chips) do not leave the appliance unattended.
- Switch the cooking zones off after each use.
- Users with implanted pacemakers should keep their upper body at least 30 cm from induction cooking zones that are switched on.
- Risk of burns! Do not place objects made of metal, such as knives, forks, spoons and saucepan lids on the cooking surface, as they can get hot.

Safety when cleaning

- For cleaning, the appliance must be switched off and cooled down.
- For safety reasons, the cleaning of the appliance with steam jet or high-pressure cleaning equipment is not permitted.

How to avoid damage to the appliance

- The ceramic glass can be damaged by objects falling onto it.
- The edge of the ceramic glass can be damaged by being knocked by the cookware.
- Cookware made of cast iron, cast aluminium or with damaged bottoms can scratch the ceramic glass if pushed across the surface.
- Objects that melt and things that boil over can burn onto the ceramic glass and should be removed straightaway.
- Do not use the cooking zones with empty cookware or without cookware.
- The ventilation gap of 5mm between the worktop and front of the unit underneath it must not be covered.

Description of the Appliance

Cooking surface layout

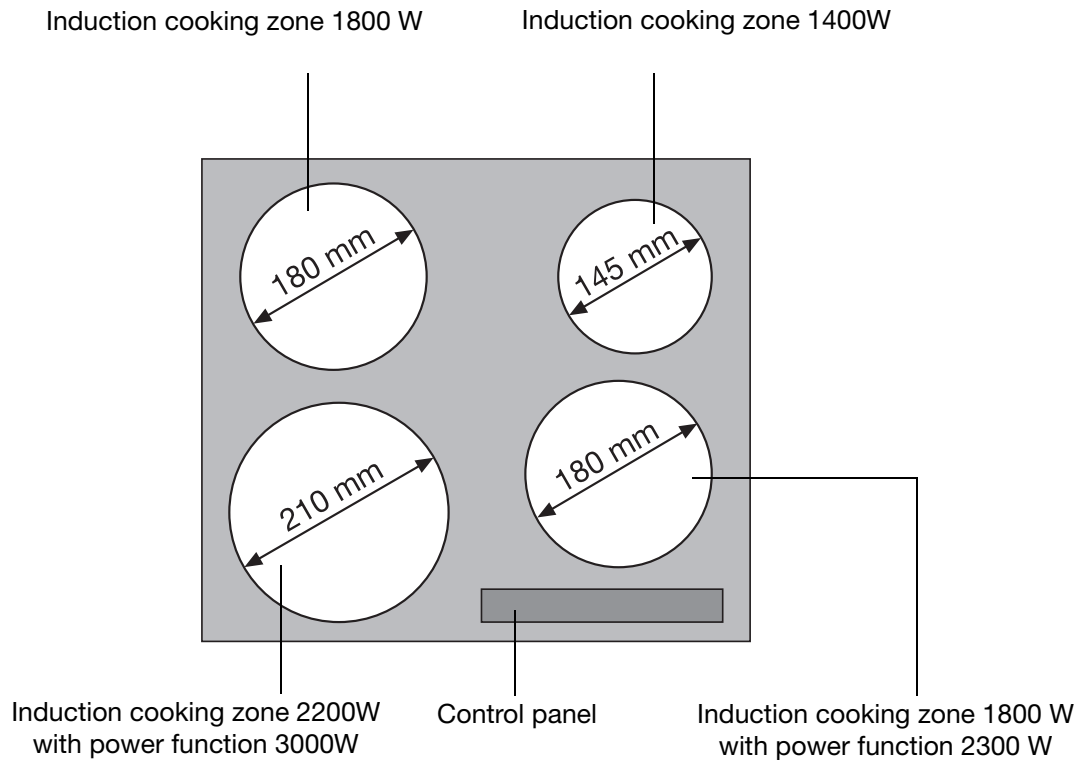

Control panel layout

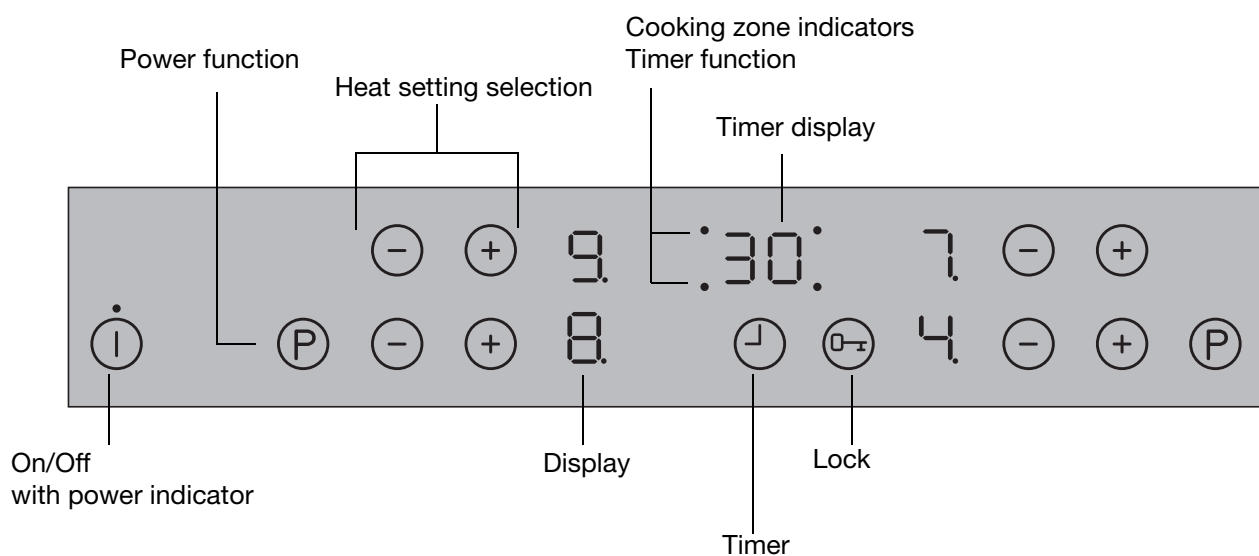

Touch Control sensor fields

The appliance is operated using Touch Control sensor fields. Functions are controlled by touching sensor fields and confirmed by displays and acoustic signals.

Touch the sensor fields from above, without covering other sensor fields.

	Sensor field	Function
①	On / Off	Switches appliance on and off
⊕	Increase settings	Increasing heat setting/time
⊖	Decrease settings	Decreasing heat setting/time
⌚	Timer	Timer selection
🔒	Lock	Locking/unlocking the control panel
Ⓟ	Power	Switching the power function on and off

Displays

Display	Description
⓪	Cooking zone is switched off
Ⓤ	Keep warm setting
Ⓛ - ⓖ	Heat settings
Ⓡ	Automatic warm up function
ⓔ	Fault
ⓕ	Pan detection
ⓗ	Residual heat
Ⓛ	Child safety device
Ⓟ	Power
Ⓢ	Safety cut-out

Residual heat indicator



Warning! Risk of burns from residual heat. After being switched off, the cooking zones need some time to cool down. Look at the residual heat indicator **H**.



Residual heat can be used for melting and keeping food warm.

The **induction cooking zones** create the heat required for cooking directly in the base of the cookware. The glass ceramic is merely heated by the residual heat of the cookware.

The **cooling fan** switches itself on and off depending upon the temperature of the electronics.

Operating the appliance

i Use the induction cooking zones with suitable cookware.

Switching the appliance on and off

	Control panel	Display	Pilot light
Switch on	Touch ⏻ for 2 seconds	0 / H	lights up
Switch off	Touch ⏻ for 1 second	H / none	goes out













i After switching on, within approx. 10 seconds a heat setting or a function must be set, otherwise the appliance automatically switches itself off.

Selecting the heat setting





	Control panel	Display
Increase	Touch +	0 to 9 / P
Decrease	Touch -	9 to 0
Switch off	Touch + and - at the same time	0



i The keep warm setting **0** lies between **9** and **1**. The keep warm setting can be set using **+** or **-**. It is used to keep food warm.

Using the automatic warm-up function











Step	Control panel	Display
1.	Setting the level  / 	 / 
2.	Place to one side for a moment	 / 
3.	 touch	
4.	 touch in order to set the desired cooking setting	 until  /  after 3 seconds 

All cooking zones are equipped with an automatic warm-up function. The automatic warm-up function sets the cooking zone to the highest setting for a certain period of time and then automatically switches back to the cooking setting that was originally set.

 If during the automatic warm up  a higher heat setting is selected, e.g. from  to , the automatic warm up is adjusted.



 If there is still residual heat on the cooking zone (display ) , the automatic warm up is not performed.

The length of time that the automatic warm up function operates depends on the heat setting selected.

Heat setting	Length of the automatic warm up [min.]
	0:10
	0:10
	0:10
	3:10
	5:50
	10:10
	2:00
	2:30
	2:50
	---

Locking/unlocking the control panel

The control panel, with the exception of the “On/Off” sensor field, can be locked at any time in order to prevent the settings being changed e.g. by wiping over the panel with a cloth.





	Control panel	Display
Switch on	Touch 	 (for 5 seconds)
Switch off	Touch 	previously set heat setting

 When you switch the appliance off, the locking function is automatically switched off.

Using the child safety device



The child safety device prevents unintentional use of the appliance.

Setting the child safety device

Step	Control panel	Display/Signal
1.	① Switch on the appliance (Do not set a heat setting)	
2.	Touch 	Acoustic signal
3.	Touch 	

Appliance switches off. The child safety device is set.





Releasing the child safety device

Step	Control panel	Display/Signal
1.	① Switch on the appliance	
2.	Touch 	Acoustic signal
3.	Touch 	

Appliance switches off. The child safety device is released.

Overriding the child safety device

The child safety device can be released in this way for a single cooking session; it remains activated afterwards.

Step	Control panel	Display/Signal
1.	① Switch on the appliance	
2.	Touch  and  at the same time	 / acoustic signal

Until the appliance is next switched off, it can be used as normal.

Switching the power function on and off

The power function P makes more power available to the induction cooking zones, e.g. to bring a large quantity of water to the boil quickly.

The power function is activated for 10 minutes. After that the induction cooking zone automatically switches back to heat setting 9.

	Control panel	Display
Switch on	Touch P	P
Switch off	Touch P	9
	Touch \ominus	9

Power Management

The cooking zones have a maximum power available to them.

If this power range is exceeded by switching on the power function, Power Management reduces the heat setting of another cooking zone.

The display for this cooking zone alternates for two minutes between the set heat setting and the maximum possible heat setting. Thereafter the actual heat setting is displayed.

Example:

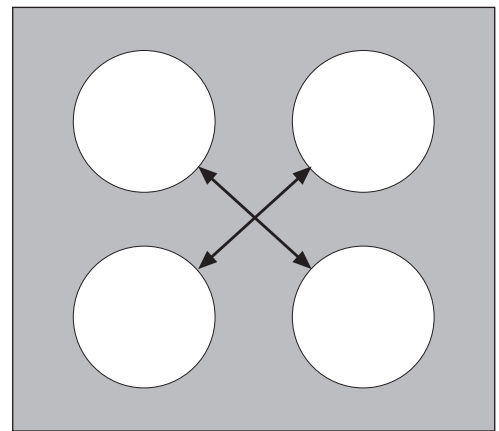

Last cooking zone switched on	Other cooking zone		
	set heat setting	display	actual heat setting
P	9	7 alternating with 9	7

i If the power function has ended, the cooking zones automatically switch back to the heat setting set previously.

Using the timer









All cooking zones can use each use one of the two timer functions at the same time.

Function	Condition	Outcome after the time has elapsed
Automatic cut-out	a heat setting is set	acoustic signal 00 flashes Cooking zone switches off
Countdown timer	cooking zones not in use	acoustic signal 00 flashes

i If a cooking zone is switched off, the timer function set is also switched off.

i If a heat setting is set on this cooking zone in addition to a countdown timer, the cooking zone is switched off after the time set has elapsed.

Selecting a cooking zone

Step	Control panel	Display
1.	Touch  once	Pilot light of the first cooking zone flashes 
2.°	Touch  once	Pilot light of the second cooking zone flashes 
3.	Touch  once	Pilot light of the third cooking zone flashes 
4.	Touch  once	Pilot light of the fourth cooking zone flashes 

i If the pilot light is flashing more slowly, the heat setting can be set or modified.

i If other timer functions are set, after a few seconds the shortest remaining time of all the timer functions is displayed and the corresponding pilot light flashes.

Setting the time

Step	Control panel field	Display
1.	⌚ Select cooking zone	Pilot light of the cooking zone selected flashes
2.	Touch ⊕ or ⊖ for the cooking zone selected	00 to 99 minutes

After a few seconds the pilot light flashes more slowly.
The time is set.
The time counts down.

Switching off the timer function

Step	Control panel field	Display
1.	⌚ Select cooking zone	Pilot light of the cooking zone selected flashes faster The time remaining is displayed
2.	Touch ⊖ for the cooking zone selected	The time remaining counts down to 00.

The pilot light goes out.
The timer function for the selected cooking zone is switched off.

Changing the time

Step	Control panel field	Display
1.	⌚ Select cooking zone	Pilot light of the cooking zone selected flashes faster The time remaining is displayed
2.	Touch ⊕ or ⊖ for the cooking zone selected	01 to 99 minutes

After a few seconds the pilot light flashes more slowly.
The time is set.
The time counts down.

Displaying the time remaining for a cooking zone

Step	Control panel field	Display
1.	⌚ Select cooking zone	Pilot light of the cooking zone selected flashes faster The time remaining is displayed

After a few seconds the pilot light flashes more slowly.

Switching off the acoustic signal

Step	Control panel field	Acoustic signal
1.	Touch ⌚	Acoustic signal to acknowledge.

Acoustic signal stops.

Safety cut-out

Cooking surface



- If after switching on the cooking surface, a heat setting is not set for a cooking zone within approx. 10 seconds, the cooking surface automatically switches itself off.
- If one or more sensor fields are covered for longer than approx. 10 seconds, e.g. by a pan placed upon it, a signal sounds and the cooking surface switches off automatically.
- If all cooking zones are switched off, the cooking surface automatically switches itself off after approx. 10 seconds.

Control panel



Moisture (e.g. a wet cloth) or liquid boiling over onto the control panel immediately switches all cooking zones off.

Induction cooking zones

- In the event of overheating (e.g. when a pan boils dry) the cooking zone automatically switches itself off.  is displayed. Before being used again, the cooking zone must be set to  and allowed to cool down.
- If cookware that is not suitable is used,  flashes in the display and after 10 minutes the display for the cooking zone switches itself off.
- If one of the cooking zones is not switched off after a certain time, or if the heat setting is not modified, the relevant cooking zone switches off automatically.

Heat setting	Switches off after
1 - 2	6 hours
3 - 4	5 hours
5	4 hours
6 - 9	1.5 hours

Tips on cooking and frying

i Information about acrylamides

According to the latest scientific research, intensive browning of food, especially in products containing starch, may present a health risk due to acrylamide. Therefore we recommend cooking at low temperatures and not browning foods too much.

Cookware for induction cooking zones

Cookware made of	suitable
Steel, enamelled steel	yes
Cast iron	yes
Stainless steel	if appropriately labelled by the manufacturer
Aluminium, copper, brass	---
Glass, ceramic, porcelain	---

i Cookware for induction cooking zones is labelled as suitable by the manufacturer.

Test of suitability

Cookware is suitable for induction, if ...

- ... a little water is heated on an induction cooking zone set to heat setting 9 within a few seconds.
- ... a magnet sticks to the bottom of the cookware.

i Certain cookware can make noises when being used on induction cooking zones. These noises are not a fault in the appliance and do not affect operation in any way.

Pan size

Induction cooking zones adapt automatically to the size of the cookware bottom up to a certain limit. However the magnetic part of the cookware bottom must have a minimum diameter depending upon the size of the cooking zone.

i The cookware must be placed centrally on the cooking zone.

Tips on energy saving



Place cookware on the cooking zone before it is switched on.



If possible, always place a lid on the cookware.

Examples of cooking applications

The information given in the following table is for guidance only.

Heat setting	Cooking process	suitable for	Cook time	Tips/Hints
0		Off position		
1	Keeping food warm	Keeping cooked foods warm	as required	Cover
1-2	Melting	Hollandaise sauce, melting butter, chocolate, gelatine	5-25 mins.	Stir occasionally
	Solidifying	Fluffy omelettes, baked eggs	10-40 mins.	Cook with lid on
2-3	Simmering	Simmering rice and milk-based dishes Heating up ready-cooked meals	25-50 mins.	Add at least twice as much liquid as rice, stir milk dishes part way through cooking
3-4	Steaming Braising	Steaming vegetables, fish Braising meat	20-45 mins.	With vegetables add only a little liquid (a few tablespoons)
4-5	Boiling	Steaming potatoes	20-60 mins.	Use only a little liquid, e. g.: max. ¼ l water for 750 g of potatoes
		Cooking larger quantities of food, stews and soups	60-150 mins.	Up to 3 l liquid plus ingredients
6-7	Gentle frying	Frying escalope, veal cordon bleu, cutlets, rissoles, sausages, liver, roux, eggs, pancakes, doughnuts	as required	Turn halfway through cooking
7-8	Heavy frying	Hash browns, loin steaks, steaks, Flädle (pancakes for garnishing soup)	5-15 mins. per pan	Turn halfway through cooking
9	Boiling Searing Deep frying	Boiling large quantities of water, cooking pasta, searing meat (goulash, pot roast), deep frying chips		

The power function is suitable for heating large quantities of liquid.

Cleaning and care



Take care! Risk of burns from residual heat.



Important Sharp objects and abrasive cleaning materials will damage the appliance. Clean with water and washing up liquid.



Important Residues from cleaning agents will damage the appliance. Remove residues with water and washing up liquid.

Cleaning the appliance after each use

1. Wipe the appliance with a damp cloth and a little washing up liquid.
2. Rub the appliance dry using a clean cloth.

Removing deposits

1. Place the scraper on the glass ceramic surface at an angle.
2. Remove residues by sliding the blade over the surface.
3. Wipe the appliance with a damp cloth and a little washing up liquid.
4. Rub the appliance dry using a clean cloth.

Type of dirt	Remove		
	immediately	when the appliance has cooled down	using
sugar, food containing sugar	yes	---	a scraper*
plastics, tin foil	yes	---	
limescale and water rings	---	yes	cleaner for glass ceramic or stainless steel*
fat splashes	---	yes	
shiny metallic discolorations	---	yes	

*Scrapers and cleaners for glass ceramic and stainless steel can be purchased in specialist shops, supermarkets, the parts department of your local Service Force Centre or from www.shop.electrolux.co.uk











Remove stubborn residues with a cleaner for glass ceramic or stainless steel.



Scratches or dark stains on the glass ceramic that cannot be removed do not however affect the functioning of the appliance.

What to do if ...

Problem	Possible cause	Remedy
The cooking zones will not switch on or are not functioning	More than 10 seconds have passed since the appliance was switched on	Switch the appliance on again.
	The lock is switched on 	Switch off the lock (See the section "Locking/unlocking the control panel")
	The child safety device is switched on 	Deactivate the child safety device (See the section "Child safety device")
	Several sensor fields were touched at the same time	Only touch one sensor field
	The sensor fields are partly covered by a damp cloth or with liquid	Remove the cloth or the liquid. Switch the appliance on again.
	Safety cut-out has been triggered	Switch the appliance on again
The residual heat indicator is not displaying anything	The cooking zone was only on for a short time and is therefore not hot	If the cooking zone is supposed to be hot, call your local Service Force Centre.
The automatic warm up function is not switching itself on	There is still residual heat on the cooking zone 	Let the cooking zone cool down
	The highest heat setting is set 	The highest heat setting has the same power as the automatic warm up function
Repeated acoustic signal (6x), appliance switches off	One or more sensor fields have been covered for longer than 10 seconds	Uncover sensor field
Acoustic signal sounds and appliance switches itself on and then off again; after 5 seconds another acoustic signal sounds	The On/Off sensor field has been covered up, e.g. by a cloth	Do not place any objects on the control panel
Display is switching between two heat settings	Power management is reducing the power of this cooking zone	See the section "Switching the power function on and off"
 flashes	Unsuitable cookware	Use suitable cookware
	No cookware on the cooking zone	Place cookware on the cooking zone
	The diameter of the bottom of the cookware is too small for the cooking zone	Move onto a smaller cooking zone Use suitable cookware
 is lit	Overheating protection for the cooking zone has been triggered	Switch off the cooking zone. Switch the cooking zone on again
 and number are displayed	Electronics fault	Disconnect the appliance from the electrical supply for a few minutes (Take the fuse out of the house's wiring system) If after switching on again,  is displayed again, call the customer service department

If you are unable to remedy the problem by following the above suggestions, please contact your local Service Force Centre.



Warning! Repairs to the appliance are only to be carried out by qualified service engineers. Considerable danger to the user may result from improper repairs.



If the appliance has been wrongly operated, the visit from the service technician or dealer may not take place free of charge, even during the warranty period.

Disposal



Packaging material

The packaging materials are environmentally friendly and can be recycled. The plastic components are identified by markings, e.g. >PE<, >PS<, etc. Please dispose of the packaging materials in the appropriate container at your local waste disposal facilities.



Old appliance

The symbol  on the product or on its packaging indicates that this product may not be treated as household waste. Instead it shall be handed over to the applicable collection point for the recycling of electrical and electronic equipment. By ensuring this product is disposed of correctly, you will help prevent potential negative consequences for the environment and human health, which could otherwise be caused by inappropriate waste handling of this product. For more detailed information about recycling of this product, please contact your local city office, your household waste disposal service or the shop where you purchased the product.

Installation Instructions

Safety instructions

The laws, ordinances, directives and standards in force in the country of use are to be followed (safety regulations, proper recycling in accordance with the regulations, etc.)

Installation may only be carried out by a qualified electrician.

The minimum distances to other appliances and units are to be observed.

A protective floor must be installed under the appliance.

The cut surfaces of the worktop are to be protected against moisture using a suitable sealant.

The sealant seals the appliance to the work top with no gap.

When building in, protect the underside of the appliance from steam and moisture, e.g. from a dishwasher or oven.

Avoid installing the appliance next to doors and under windows. Otherwise hot cookware may be knocked off the rings when doors and windows are opened.



WARNING!

Risk of injury from electrical current.

- The electrical mains terminal is live.
- Observe connection schematic.
- Observe electrical safety rules.
- Ensure anti-shock protection through correct installation by a qualified electrician.
- The appliance must be connected to the electrical supply by a qualified electrician.



IMPORTANT!

Risk of injury from electrical current.

Loose and inappropriate plug and socket connections can make the terminal overheat.

- Have the clamping joints correctedly installed by a qualified electrician.
- Use strain relief clamp on cable.
- In the event of single-phase or two-phase connection, the appropriate mains cable of type H05BB-F Tmax 90° (or higher) must be used.
- If this appliance's mains cable is damaged, it must be replaced by a special cable (type H05BB-F Tmax 90°; or higher). Please contact your local Service Force Center for further advice.

A device must be provided in the electrical installation which allows the appliance to be disconnected from the mains at all poles with a contact opening width of at least 3 mm

Suitable isolation devices include line protecting cut-outs, fuses (screw type fuses are to be removed from the holder), earth leakage trips and contactors.

Sticking on the seal

- Clean the worktop in the area of the cut-out section.
- Stick the one-sided self-adhesive sealing tape supplied all the way round the lower edge of the cooking surface along the outer edge of the glass ceramic panel. Do not stretch it. The cut ends should lie in the middle of one side. When you have cut it to length (add a few mm), press the two ends flush up against one another.



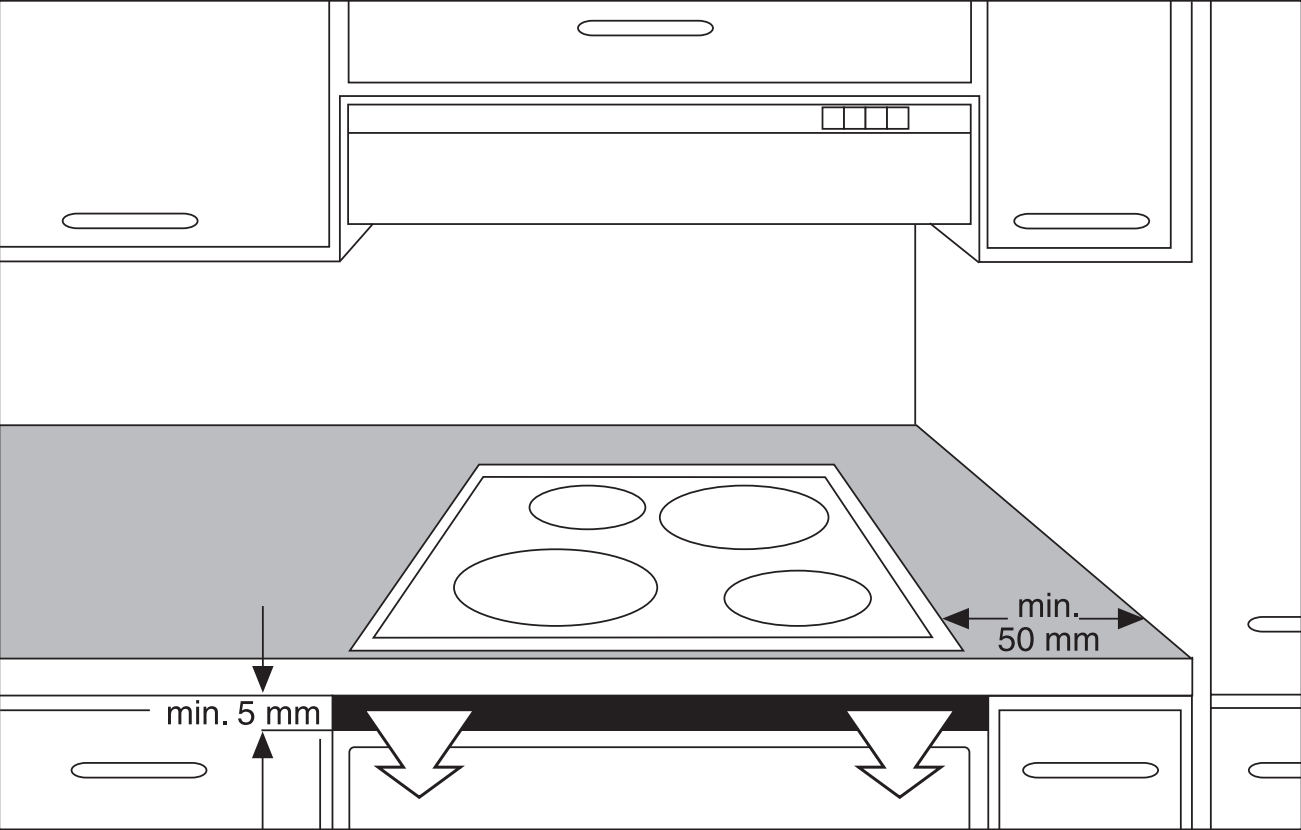
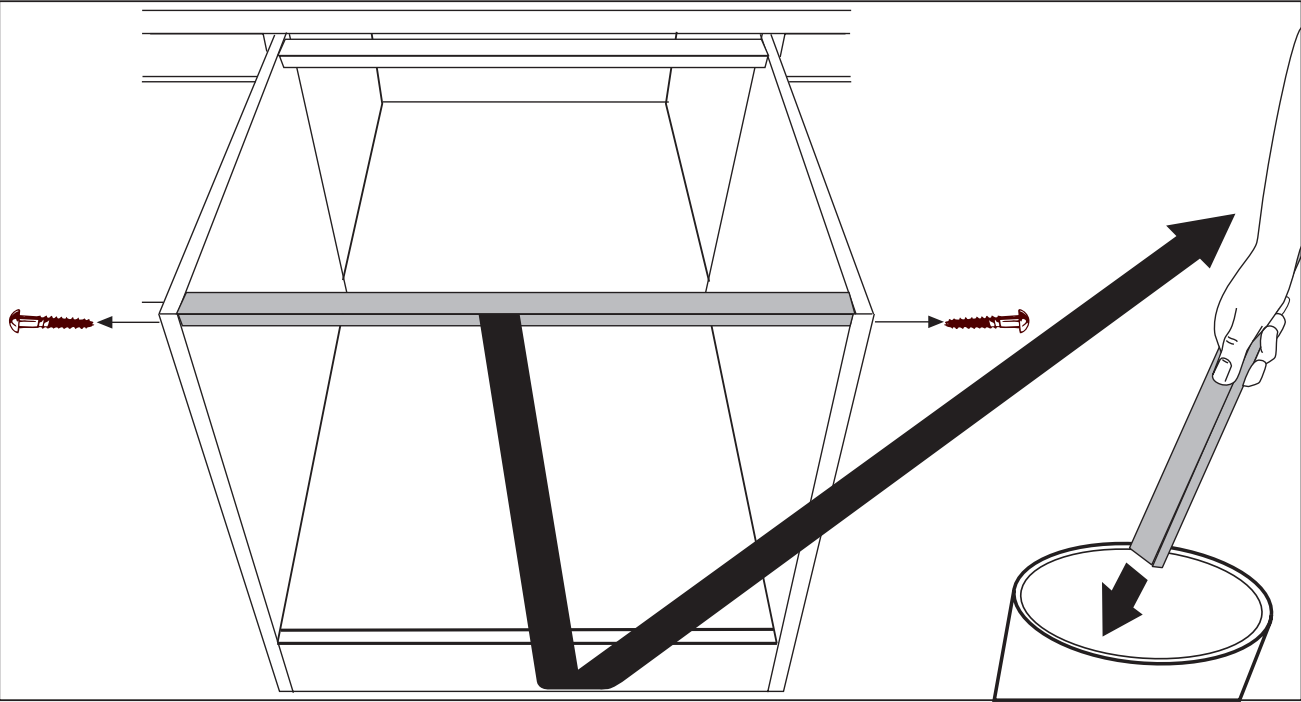

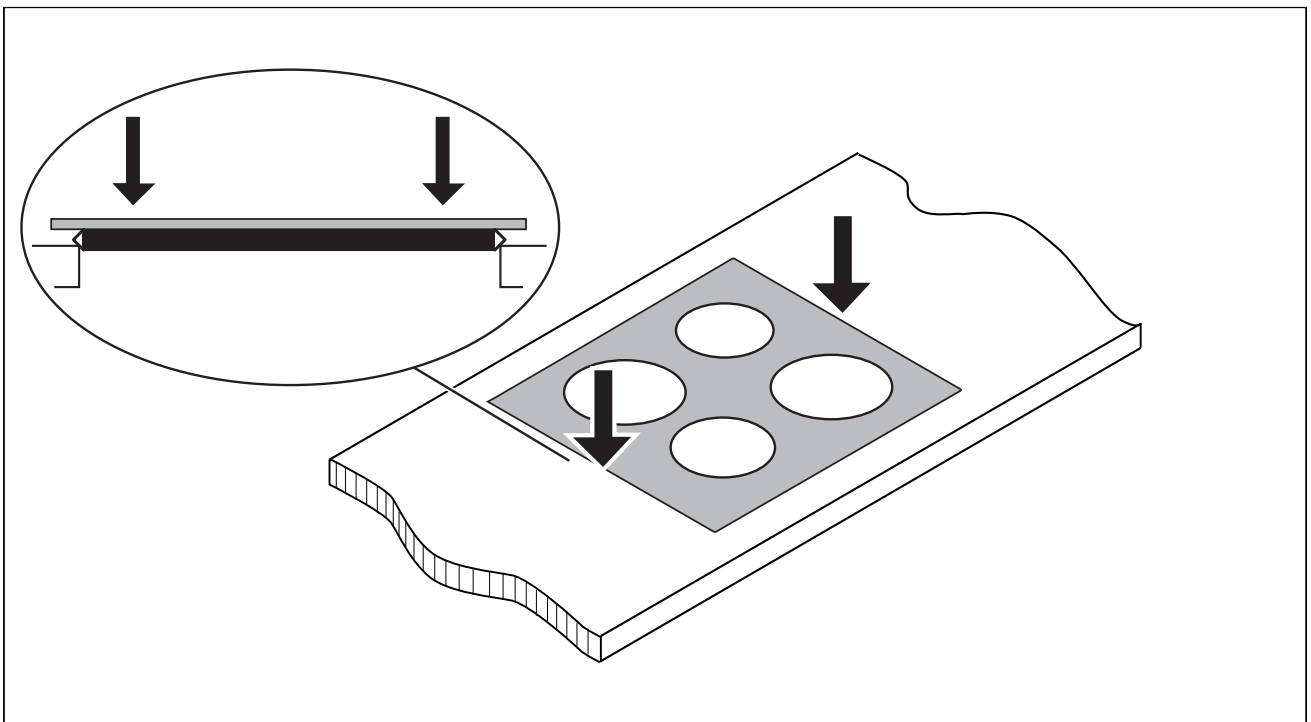
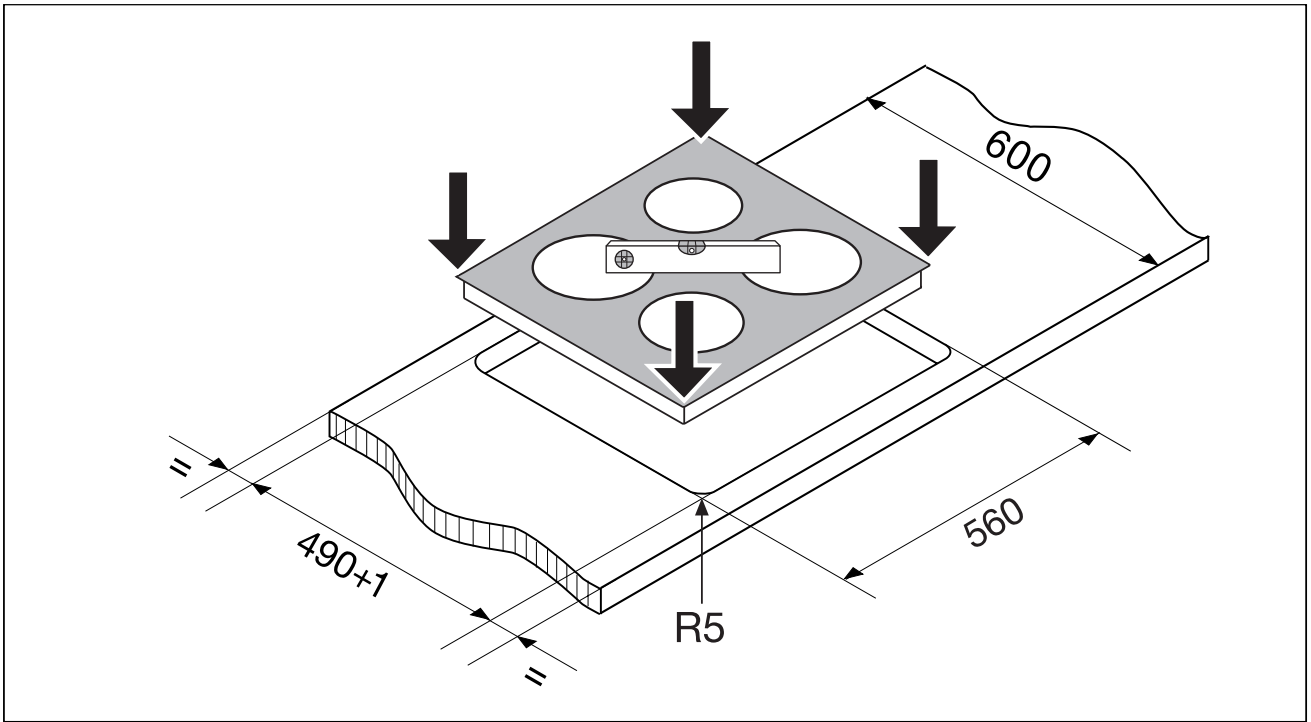
Assembly

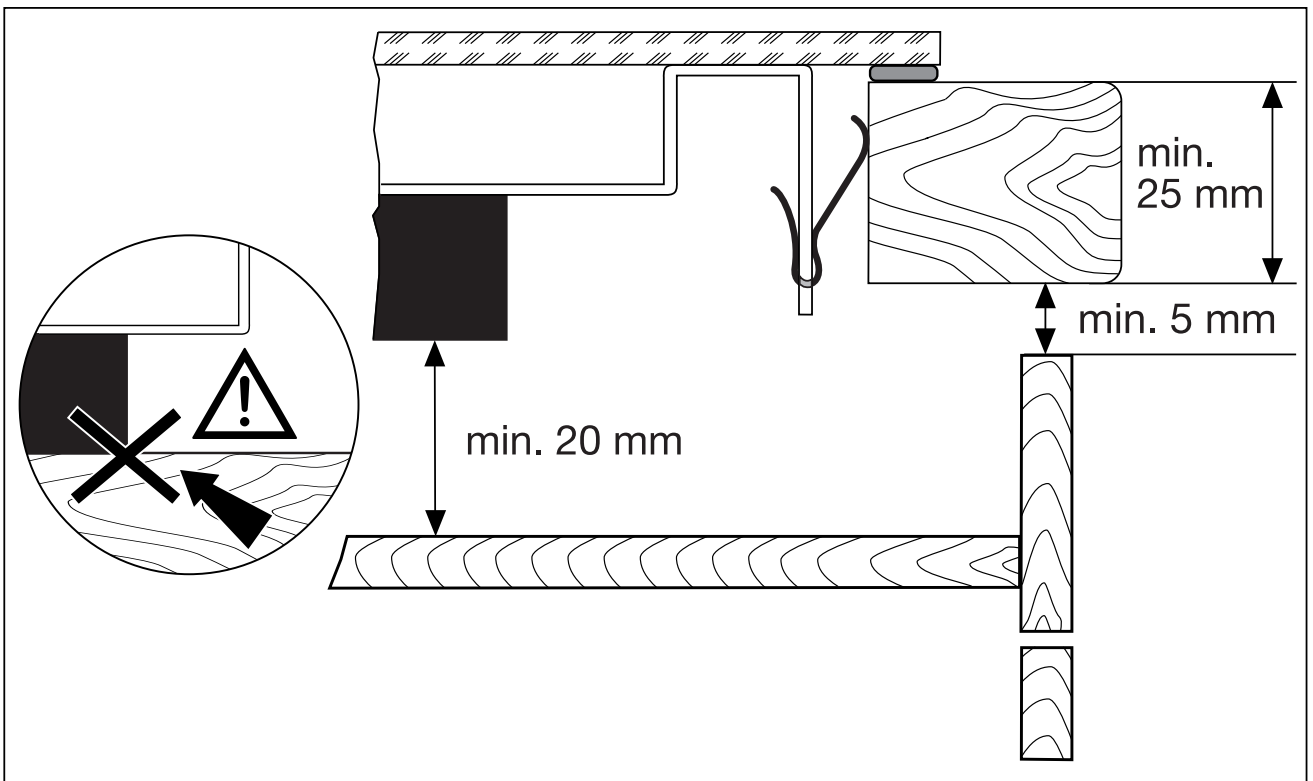
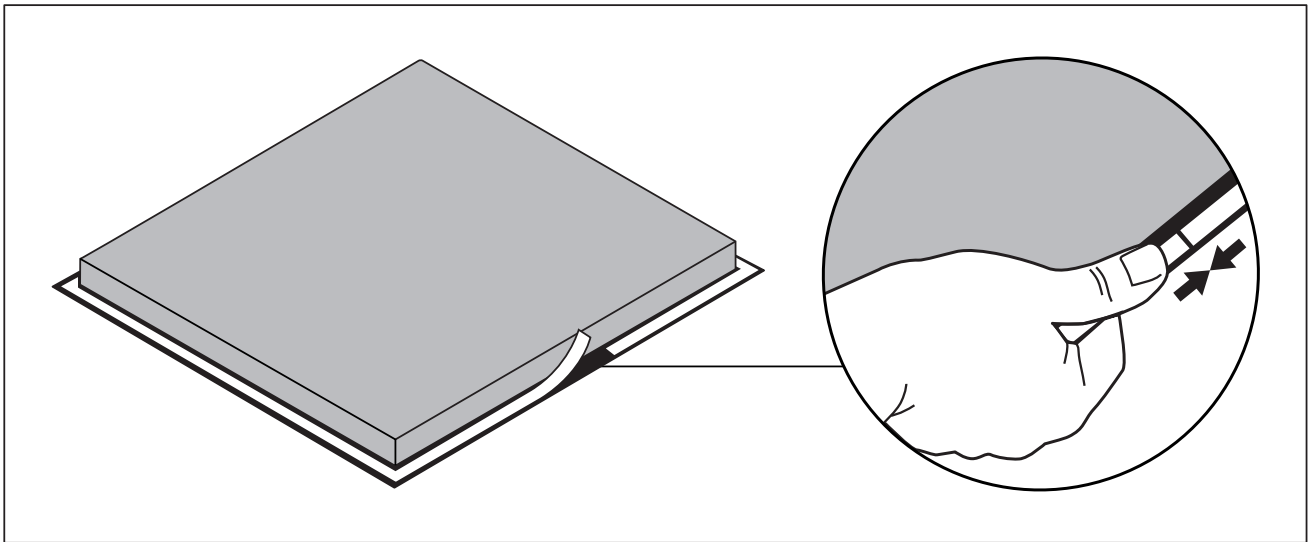





Rating Plate

Modell ZKT 651 D		Prod.Nr. 949 591 494	
Typ 55GAD80AG	230 V	50 Hz	Induction 7,2 kW
Made in Germany	Ser.Nr.	7,2 kW	
ZANUSSI	 		

Warranty conditions

Standard guarantee conditions

We, Zanussi, undertake that if within 24 months of the date of the purchase this Zanussi appliance or any part thereof is proved to be defective by reason only of faulty workmanship or materials, we will, at our option repair or replace the same FREE OF CHARGE for labour, materials or carriage on condition that:

- The appliance has been correctly installed and used only on the electricity supply stated on the rating plate.
- The appliance has been used for normal domestic purposes only, and in accordance with the manufacturer's instructions.
- The appliance has not been serviced, maintained, repaired, taken apart or tampered with by any person not authorised by us.
- All service work under this guarantee must be undertaken by a Service Force Centre.
- Any appliance or defective part replaced shall become the Company's property.
- This guarantee is in addition to your statutory and other legal rights.

Home visits are made between 8.30am and 5.30pm Monday to Friday. Visits may be available outside these hours in which case a premium will be charged.

Exclusions

This guarantee does not cover:

- Damage or calls resulting from transportation, improper use or neglect, the replacement of any light bulbs or removable parts of glass or plastic.
- Costs incurred for calls to put right an appliance which is improperly installed or calls to appliances outside the United Kingdom.
- Appliances found to be in use within a commercial environment, plus those which are subject to rental agreements.
- Products of Zanussi manufacture which are not marketed by Zanussi.

European Guarantee

If you should move to another country within Europe then your guarantee moves with you to your new home subject to the following qualifications:

- The guarantee starts from the date you first purchased your product.
- The guarantee is for the same period and to the same extent for labour and parts as exists in the new country of use for this brand or range of products.
- This guarantee relates to you and cannot be transferred to another user.
- Your new home is within the European Community (EC) or European Free Trade Area.
- The product is installed and used in accordance with our instructions and is only used domestically, i.e. a normal household.
- The product is installed taking into account regulations in your new country.

Before you move please contact your nearest Customer Care centre, listed below, to give them details of your new home. They will then ensure that the local Service Organisation is aware of your move and able to look after you and your appliances.

France	Senlis	+33 (0) 3 44 62 20 13
Germany	Nürnberg	+49 (0) 800 234 7378
Italy	Pordernone	+39 (0) 800 11 7511
Sweden	Stockholm	+46 (0) 20 78 77 50
UK	Luton	+44 (0) 8705 727 727

Service and Spare Parts

If the event of your appliance requiring service, or if you wish to purchase spare parts, please contact Service Force by telephoning:

0870 5 929 929

Your telephone call will be automatically routed to the Service Force Centre covering your post code area.

For the address of your local Service Force Centre and further information about Service Force, please visit the website at

www.serviceforce.co.uk

Before calling out an engineer, please ensure you have read the details under the heading „What to do if...“

When you contact the Service Force Centre you will need to give the following details:

1. Your name, address and post code.
2. Your telephone number.
3. Clear and concise details of the fault.
4. The model and serial number of the appliance (found on the rating plate)
5. The purchase date.

Please note that a valid purchase receipt or guarantee documentation is required for in-guarantee service calls.

Customer Care

For general enquiries concerning your Zanussi appliance, or for further information on Zanussi products please contact our Customer Care Department by letter or telephone at the address below or visit our website at **www.zanussi.co.uk**.

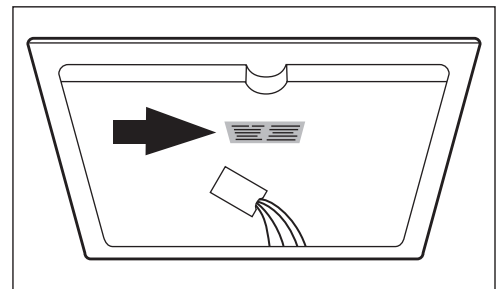

Customer Care Department
Major Appliances
Zanussi
Addington Way
Luton
Bedfordshire, LU4 9QQ
Tel: 08705 350350 (*)

For Customer Service in the Republic of Ireland please contact us at the address below:
AEG/ Electrolux Group (Ire) Ltd
Long Mile Road/ Dublin 12
Republic of Ireland
Tel: +353 (0) 1 4090751
Email: service.eid@electrolux.ie

(*) Calls may be recorded for training purposes

822 924 805-B-220905-05

ZANUSSI

Subject to change without notice

 **The Electrolux Group. The world's No. 1 choice.**

The Electrolux Group is the world's largest producer of powered appliances for kitchen, cleaning and outdoor use. More than 55 million Electrolux Group products (such as refrigerators, cookers, washing machines, vacuum cleaners, chain saws and lawn mowers) are sold each year to a value of approx. USD 14 billion in more than 150 countries around the world.