



SAMSUNG

LCD TV

LA27T51B

LA32T51B

- AFTER SALES SERVICE

- Do not hesitate to contact your retailer or service agent if a change in the performance of your product indicates that a faulty condition may be present.



SAMSUNG

ELECTRONICS

Owner's Instructions

Before operating the unit,
please read this manual thoroughly,
and retain it for future reference.

**ON-SCREEN MENUS
PC DISPLAY
PICTURE IN PICTURE (PIP)
TELETEXT**

Precautions When Displaying a Still Image

A still image may cause permanent damage to the TV screen.

- Do not display a still image on the LCD panel for more than 2 hours as it can cause screen image retention. This image retention is also known as "screen burn". To avoid such image retention, reduce the degree of brightness and contrast of the screen when displaying a still image.
-  Watching the LCD TV in 4:3 format for a long period of time may leave traces of borders displayed on the left, right and center of the screen caused by the difference of light emission on the screen. Playing a DVD or a game console may cause a similar effect to the screen. Damages caused by the above effect are not covered by the Warranty.
- Displaying still images from Video games and PC for longer than a certain period of time may produce partial after-images. To prevent this effect, reduce the 'brightness' and 'contrast' when displaying still images.

Contents

CONNECTING AND PREPARING YOUR TV

- List of Parts 2
- Installing the Stand 2
- Installing the Wall Mount Kit 2
- Viewing the Control Panel 3
- Viewing the Connection Panel 4
- Viewing the Remote Control 5
- Installing Batteries in the Remote Control 6
- Switching On and Off 6
- Placing Your Television in Standby Mode 6
- Plug & Play 6

SETTING THE CHANNELS

- Storing Channels Automatically 7
- Storing Channels Manually 8
- Editing the Channels 8

SETTING THE PICTURE

- Changing the Picture Standard 9
- Adjusting the Custom Picture 9
- Changing the Colour Tone 10
- Resetting the Picture Settings to the
Factory Defaults 10
- Changing the Picture Size 10
- Digital Noise Reduction / Dynamic Contrast 11
- Viewing the Picture In Picture (PIP) 11

SETTING THE SOUND

- Changing the Sound Standard 12
- Adjusting the Sound Settings 12
- Adjusting the Volume Automatically 12
- Listening to the Sound of the Sub Picture 13

SETTING THE TIME

- Setting and Displaying the Current Time 13
- Setting the Sleep Timer 13
- Switching the Television
On and Off Automatically 14

SETTING THE OTHERS

- Choosing Your Language 14
- Using the Energy Saving Feature 15
- Setting the Blue Screen Mode /
Selecting the Melody 15
- Selecting the Source 15
- Editing the Input Source Names 16

USING THE TELETEXT FEATURE

- Teletext Decoder 16
- Displaying the Teletext Information 17
- Selecting a Specific Teletext Page 17
- Using Fasttext to Select a Teletext Page 18

SETTING THE PC

- Setting up Your PC Software
(Based on Windows XP) 18
- Display Modes 18
- Setting the PC 19

RECOMMENDATIONS FOR USE

- Troubleshooting:
Before Contacting Service Personnel 20
- Technical and Environmental Specifications 20

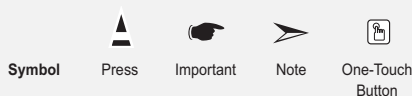

CONNECTING AND PREPARING YOUR TV

List of Parts

Please make sure the following items are included with your LCD TV.
If any items are missing, contact your dealer.

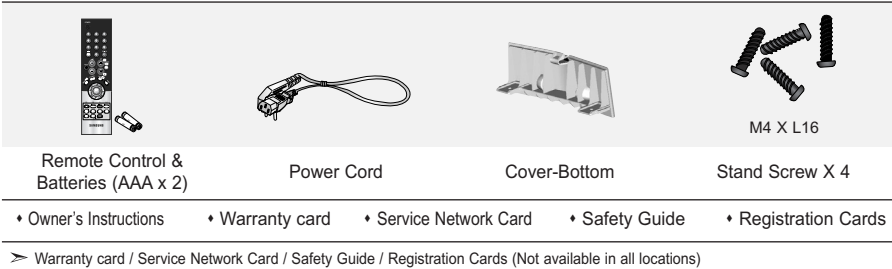

Installing the Stand

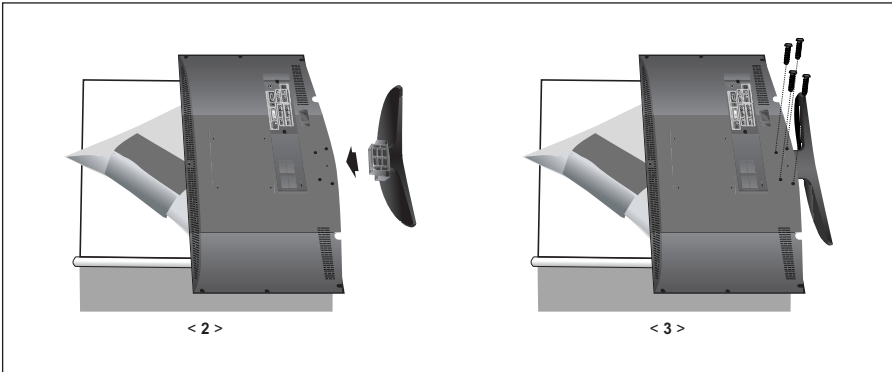

1. Place the TV faced down on a soft cloth or cushion on a table.
2. Put the stand into the hole at the bottom of the TV.
3. Insert screw into the hole indicated and tighten.

Installing the Wall Mount Kit

Wall mount items (sold separately) allow you to mount the TV on the wall.
For detailed information on installing the wall mount, see the instructions provided with the Wall Mount items. Contact a technician for assistance when installing the wall mounted bracket.
Samsung Electronics is not responsible for any damage to the product or injury to yourself or others if you elect to install the TV on your own.

Viewing the Control Panel

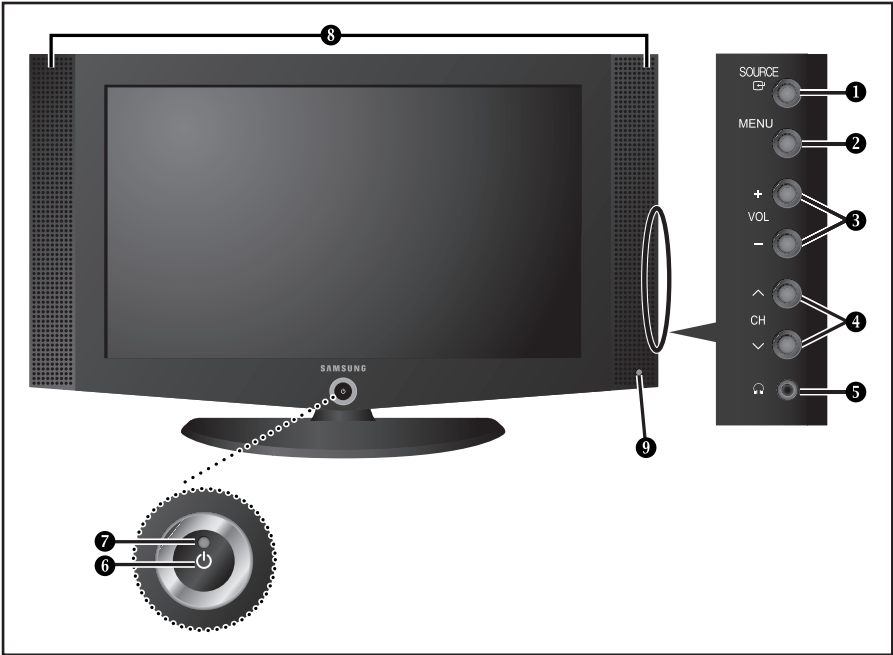

➤ The product colour and shape may vary depending on the model.

1 SOURCE

Toggles between all the available input sources (TV, AV1, AV2, S-Video, Component1, Component2, PC, DVI).

In the on-screen menu, use this button as you use the **ENTER**  button on the remote control.

2 MENU

Press to see an on-screen menu of your TV's features.

3 VOL +

Press to decrease or increase the volume.

In the on-screen menu, use the **- VOL +** buttons as you use the **◀** and **▶** buttons on the remote control.

4 CH ^

Press to change channels.

In the on-screen menu, use the **∨ CH ^** buttons as you use the **∨** and **▲** buttons on the remote control.

5 (HEADPHONE JACK)

Connect a set of external headphones to this jack for private listening.

6 (POWER)

Press to turn the TV on and off.

7 POWER INDICATOR

Blinks and turns off when the power is on and lights up in stand-by mode.

8 SPEAKERS

9 REMOTE CONTROL SENSOR

Aim the remote control towards this spot on the TV.

Viewing the Connection Panel

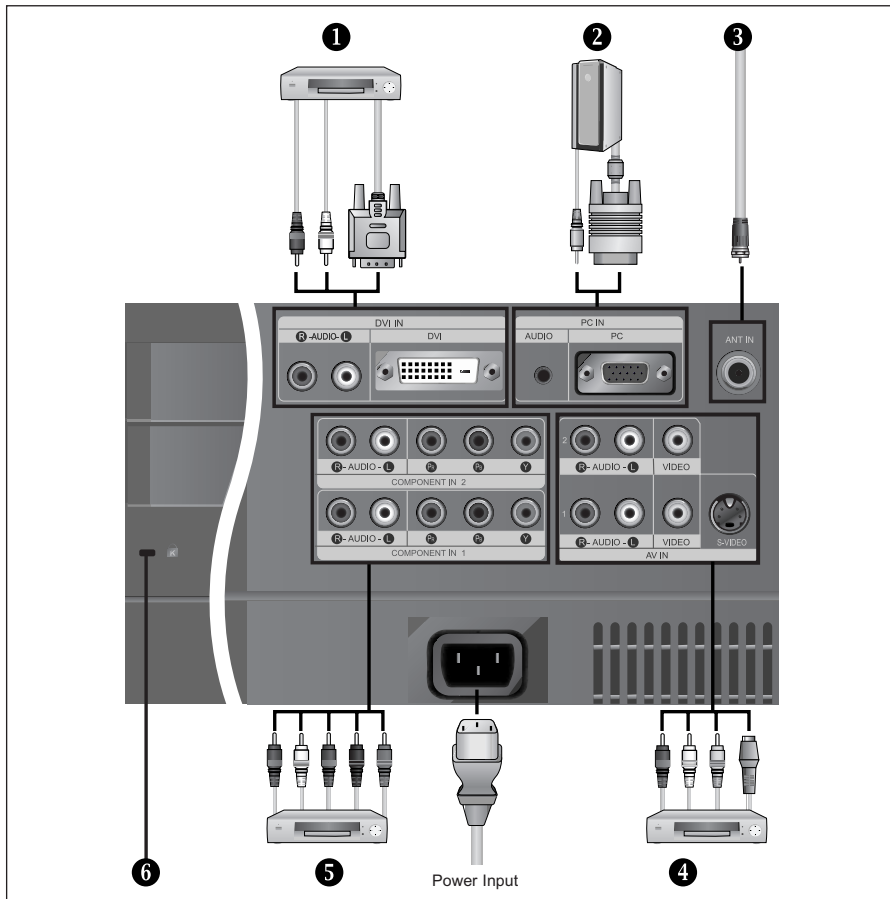

- ☛ Whenever you connect an external device to your TV, make sure that power on the unit is turned off.
- ☛ When connecting an external device, match the colour of the connection terminal to the cable.

1 Connecting DVI

- Connect the DVI connector to the DVD connector.
- Connect the stereo audio cable (optional) to "R - AUDIO - L" on the rear of your set and the other ends to the corresponding audio out connectors on the A/V device.
- DVI does not support PC function.
- This LCD TV displays the optimum picture in 720p mode.

2 Connecting Computer

- Connect the D- Sub cable (optional) to "PC (PC IN)" on the rear of your set and the other end to the Video Card of your computer.
- Connect the stereo audio cable (optional) to "AUDIO (PC IN)" on the rear of your set and the other end to "Audio Out" of the sound card on your computer.

3 Connecting an Aerial or Cable Television Network

- To view television channels correctly, a signal must be received by the set from one of the following sources:
- An outdoor aerial / A cable television network / A satellite network

4 Connecting External A/V Devices

- Connect RCA (optional) or S-VIDEO cable (optional) to an appropriate external A/V device such as VCR, DVD or Camcorder.
- Connect RCA audio cables (optional) to "R - AUDIO - L" on the rear of your set and the other ends to corresponding audio out connectors on the A/V device.

5 Connecting Component Devices (DTV/DVD)

- Connect component video cables (optional) to component connector ("Pr", "Pb", "Y") on the rear of your set and the other ends to corresponding component video out connectors on the DTV or DVD.
- If you wish to connect both the Set-Top Box and DTV (or DVD), you should connect the Set-Top Box to the DTV (or DVD) and connect the DTV (or DVD) to component connector ("Pr", "Pb", "Y") on your set.
- The Pr, Pb and Y connectors on your component devices (DTV or DVD) are sometimes labeled Y, B-Y and R-Y or Y, Cb and Cr.
- Connect RCA audio cables (optional) to "R - AUDIO - L" on the rear of your set and the other ends to corresponding audio out connectors on the DTV or DVD.
- This LCD TV displays the optimum picture in 720p mode.

6 Kensington Lock

- The Kensington lock (optional) is a device used to physically fix the system when used in a public place.
- If you want to use a locking device, contact the dealer where you purchased the TV.

Viewing the Remote Control

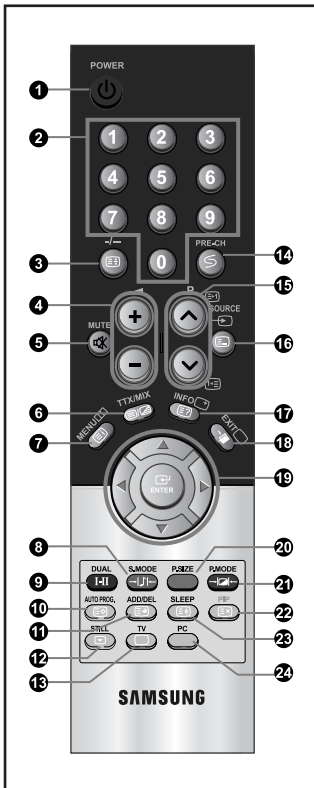

- 1 Television Standby button
 - 2 Number buttons for direct channel access
 - 3 One/Two-digit channel selection
 - 4 Volume increase
 Volume decrease
 - 5 Temporary sound switch-off
 - 7 Displays the main on-screen menu
 - 8 Sound mode selection
 - 9 Sound effect selection
 - 10 Press to automatically store selected TV/cable channels
 - 11 Use to store and delete channels to/from memory
 - 12 Picture freeze
 - 13 Selects the TV mode directly
 - 14 Previous channel
 - 15 P : Next channel
P : Previous channel
 - 16 Available source selection
 - 17 Use to see information on the current broadcast
 - 18 Exit the on-screen menu
 - 19 Control the cursor in the menu
 - 20 Picture size selection
 - 21 Picture effect selection
 - 22 Picture-In-Picture On/Off
 - 23 Automatic Power-off
 - 24 Selects the PC mode directly
- Teletext Functions**
- 3 Teletext hold
 - 6 Teletext display/mix both teletext information and the normal broadcast
 - 7 Teletext index
 - 10 Teletext store
 - 11 Teletext sub page
 - 13 18 Exit from the teletext display
 - 15 P : Teletext next page
P : Teletext previous page
 - 16 Teletext mode selection (LIST/FLOF)
 - 17 Teletext reveal
 - 22 Teletext cancel
 - 23 Teletext size selection
- 8 9 20 21
Fastexit topic selection

➤ The performance of the remote control may be affected by bright light.

Installing Batteries in the Remote Control

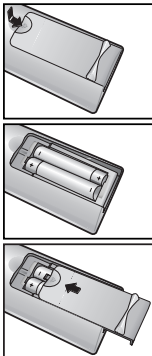

1. Slide the cover out completely.
2. Install two AAA size batteries.
 - Make sure to match the "+" and "-" ends of the batteries with the diagram inside the compartment.
3. Replace the cover.
 - Remove the batteries and store them in a cool, dry place if you won't be using the remote control for a long time. The remote control can be used up to about 23 feet from the TV. (Assuming typical TV usage, the batteries last for about one year.)

➤ **If the remote control doesn't work, check the following:**

1. Is the TV power on?
2. Are the plus and minus ends of the batteries reversed?
3. Are the batteries drained?
4. Is there a power outage, or is the power cord unplugged?
5. Is there a special fluorescent light or neon sign nearby?

Switching On and Off

The mains lead is attached to the rear of your set.

1. Plug the mains lead into an appropriate socket.
 - The standby indicator lights up on the front of the set.
2. Press the **POWER** button on the front of the set.
 - The programme that you were watching last is reselected automatically.
3. Press the numeric button (0-9) or channel up/down (▲/▼) button on the remote control or ✓ CH ▲ button on the right side of the set.
 - When you switch the set on for the very first time, you will be asked to choose language in which the menus are to be displayed.
4. To switch your set off, press the **POWER** button again.

Placing Your Television in Standby Mode

Your set can be placed in standby mode in order to reduce the power consumption. The standby mode can be useful when you wish to interrupt viewing temporarily (during a meal, for example).

1. Press the **POWER** button on the remote control.
 - The screen is turned off and a red standby indicator appears on the front of your set.
2. To switch your set back on, simply press the **POWER** button, numeric buttons (0-9) or channel up/down (▲/▼) button again.
 - Do not leave your set in standby mode for long periods of time (when you are away on holiday, for example). It is best to unplug the set from the mains and aerial.

Plug & Play

Plug & Play

When the TV is initially powered on, several basic settings proceed automatically and subsequently. The following settings are available.

1. Press the **POWER** button on the remote control.
The message "Plug & Play" is displayed.
2. Select the appropriate language by pressing the ▲ or ▼ button.
Press the **ENTER** button to confirm your choice.
3. The message "Check antenna input." is displayed with "OK" selected.
Press the **ENTER** button.
 - Please check that the antenna cable is connected correctly.

4. Select the appropriate country by pressing the **▲** or **▼** button. Press the **ENTER** button to confirm your choice.
5. The "Auto Store" menu is displayed with the "Start" selected. Press the **ENTER** button.
 - The channel search will start and end automatically. After all the available channels are stored, the "Clock Set" menu appears.
 - Press the **ENTER** button at any time to interrupt the memorization process.
6. Press the **ENTER** button. Select the "Hour" or "Minute" by pressing the **◀** or **▶** button. Set the "Hour" or "Minute" by pressing the **▲** or **▼** button.
 - You can also set the hour and minute by pressing the number buttons on the remote control.
7. Press the **ENTER** button to confirm your setting.

- ♦ **Language:** Select your language.
- ♦ **Country:** Select your country.
- ♦ **Auto Store:** Automatically scans for and stores channels available in the local area.
- ♦ **Clock Set:** Sets the current time for the TV clock.



If you want to reset this feature...

1. Press the **MENU** button to display the menu. Press the **▲** or **▼** button to select "Setup", then press the **ENTER** button.
2. Press the **ENTER** button again, to select "Plug & Play".
3. This will change or reset the settings.

SETTING THE CHANNELS



- **Storing Channels Automatically (Refer to page 7)**
- **Storing Channels Manually (Refer to page 8)**
- **Editing the Channels (Refer to page 8)**

Storing Channels Automatically

You can scan for the frequency ranges available to you (and availability depends on your country). Automatically allocated programme numbers may not correspond to actual or desired programme numbers. However, you can sort numbers manually and clear any channels you do not wish to watch.

1. Press the **MENU** button to display the menu. Press the **▲** or **▼** button to select "Channel", then press the **ENTER** button.
2. Press the **ENTER** button to select "Area".
3. Select the appropriate country by pressing the **▲** or **▼** button. Press the **ENTER** button to confirm your choice.
4. Press the **▲** or **▼** button to select "Auto Store", then press the **ENTER** button.
5. Press the **ENTER** button.
 - The TV will begin memorizing all of the available channels.
 - Press the **ENTER** button at any time to interrupt the memorization process and return to the "Channel" menu.
6. After all the available channels are stored, the "Sort" menu appears.

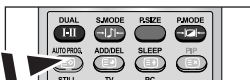













Channels can be stored automatically by simply pressing the **AUTO PROG.** button on the remote control.

Storing Channels Manually

You can store up to 100 channels, including those received via cable networks.

When storing channels manually, you can choose:

- ◆ Whether or not to store each of the channels found.
- ◆ The programme number of each stored channel which you wish to identify.

1. Press the **MENU** button to display the menu.
Press the **▲** or **▼** button to select "Channel", then press the **ENTER**  button.
2. Press the **▲** or **▼** button to select "Manual Store", then press the **ENTER**  button.
3. Press the **ENTER**  button to select "Programme".
4. To assign a programme number to a channel, find the correct number by pressing the **▲** or **▼** button and then press the **ENTER**  button.
➤ You can also set a programme number by pressing number buttons on the remote control.
5. Press the **▲** or **▼** button to select "Colour System", then press the **ENTER**  button.
6. Select the colour standard required by pressing the **▲** or **▼** button then, press the **ENTER**  button.
7. Press the **▲** or **▼** button to select "Sound System", then press the **ENTER**  button.
8. Select the sound standard required by pressing the **▲** or **▼** button, then press the **ENTER**  button.
➤ If there is an abnormal sound or no sound, re-select the sound system required.
9. If you know the number of the channel to be stored, press the **▲** or **▼** button to select "Channel".
Press the **ENTER**  button. Select **C** (Air channel) or **S** (Cable channel) by pressing the **▲** or **▼** button.
Press the **▶** button to select channel. Select the required number by pressing the **▲** or **▼** button and then press the **ENTER**  button.
➤ Channel mode: P (Programme mode), C (Air channel mode), S (Cable channel mode)
➤ You can also set a channel number by pressing number buttons on the remote control.
10. If you do not know the channel numbers, press the **▲** or **▼** button to select "Search". Press the **ENTER**  button. Search by pressing the **▲** or **▼** button and then press the **ENTER**  button.
11. Press the **▲** or **▼** button to select "Store". Press the **ENTER**  button to select "OK".
12. Repeat steps 3 to 11 for each channel to be stored.





- ◆ **Programme:** Selects a program number for the channel.
- ◆ **Colour System:** Sets the colour supporting system.
- ◆ **Sound System:** Sets the sound supporting system.

- ◆ **Channel:** Selects a channel.
- ◆ **Search:** Scans for the frequency value for the channel.
- ◆ **Store:** Saves your settings.

Editing the Channels

You can exclude the channels you chose from the channels you scanned. When you scan through the stored channels, those you have chosen to skip are not displayed.

All channels that you do not specifically choose to skip are displayed during scanning.

1. Use the number buttons to directly select the channel that will be added or deleted.
2. Press the **MENU** button to display the menu.
Press the **▲** or **▼** button to select "Channel", then press the **ENTER**  button.
3. Press the **▲** or **▼** button to select "Add/Delete", then press the **ENTER**  button.
4. Repeatedly pressing the **ENTER**  button will alternate between add channel and delete channel.
5. Press the **P**  /  buttons to switch to the appropriate channel, then repeat above.
6. Press the **EXIT** button to exit.

➤ You can view any channel (including an erased channel) by using the number buttons on the remote control.



 You can also add or delete channel by simply pressing the **ADD/DEL** button on the remote control.

SETTING THE PICTURE

Changing the Picture Standard

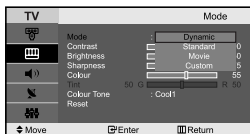

You can select the type of picture which best corresponds to your viewing requirements.

1. Press the **MENU** button to display the menu. Press the **▲** or **▼** button to select "Picture", then press the **ENTER** button.
2. Press the **ENTER** button again, to select "Mode".
3. Press the **ENTER** button again, to select "Mode".
4. Press the **▲** or **▼** button to select the desired picture effect. Press the **ENTER** button.
5. Press the **EXIT** button to exit.

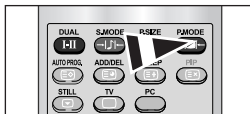

You can also press the **P.MODE** button on the remote control to select one of the picture settings.

- **Dynamic:** Selects the picture for high-definition in a bright room.
 - **Standard:** Selects the picture for optimum display in a normal environment.
 - **Movie:** Selects the picture for comfortable display in a dark room.
 - **Custom:** Select to view your favorite display settings.
- (Refer to "Adjusting the Custom Picture" on page 9)

- The Picture mode must be adjusted separately for each input source.
- You can return to the factory defaults picture settings by selecting the "Reset". (Refer to "Resetting the Picture Settings to the Factory Defaults" on page 10)

Adjusting the Custom Picture

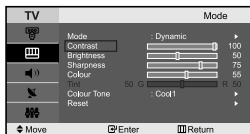

Your set has several settings which allow you to control picture quality.

1. To select the desired picture effect, follow the "Changing the Picture Standard" instructions number 1 to 4 on page 9.
2. Press the **▲** or **▼** button to select a particular item. Press the **ENTER** button.
3. Press the **◀** or **▶** button to decrease or increase the value of a particular item. Press the **ENTER** button.
4. Press the **EXIT** button to exit.

- **Contrast:** Adjusts the lightness and darkness between objects and the background.
- **Brightness:** Adjusts the brightness of the whole screen.
- **Sharpness:** Adjusts the outline of objects to either sharpen them or make them dull.
- **Colour:** Adjusts the colours, making them lighter or darker.
- **Tint:** Adjusts the colour of objects, making them more red or green for a more natural look.

- The adjusted values are stored according to the selected Picture mode.

Changing the Colour Tone

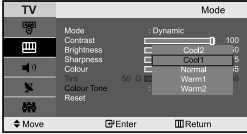

You can select the most comfortable colour tone to your eyes.

1. To select the desired picture effect, follow the "Changing the Picture Standard" instructions number 1 to 4 on page 9.
2. Press the **▲** or **▼** button to select "Colour Tone", then press the **ENTER** button.
3. Press the **▲** or **▼** button to select the desired colour tone setting. Press the **ENTER** button.
4. Press the **EXIT** button to exit.

- ♦ **Cool2:** Makes the colour temperature bluer than "Cool1" menu.
- ♦ **Cool1:** Makes whites bluish.
- ♦ **Normal:** Keeps whites white.

- ♦ **Warm1:** Makes whites reddish.
- ♦ **Warm2:** Makes the colour temperature redder than "Warm1" menu.

➤ The adjusted values are stored according to the selected Picture mode.

Resetting the Picture Settings to the Factory Defaults

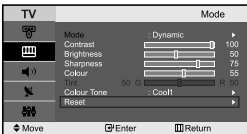

You can return to the factory defaults picture settings.

1. To select the desired picture effect, follow the "Changing the Picture Standard" instructions number 1 to 4 on page 9.
2. Press the **▲** or **▼** button to select "Reset", then press the **ENTER** button.
3. Press the **EXIT** button to exit.

➤ The "Reset" will be set for each picture mode.

Changing the Picture Size

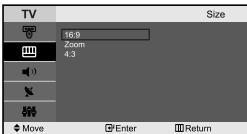

You can select the picture size which best corresponds to your viewing requirements.

1. Press the **MENU** button to display the menu. Press the **▲** or **▼** button to select "Picture", then press the **ENTER** button.
2. Press the **▲** or **▼** button to select "Size", then press the **ENTER** button.
3. Select the required option by pressing the **▲** or **▼** button. Press the **ENTER** button.
4. Press the **EXIT** button to exit.

- ♦ **16:9:** Adjusts the picture size to 16:9 appropriate for DVDs or wide broadcasting.
- ♦ **Zoom:** Magnifies the 16:9 wide picture (in the vertical direction) to fit the screen size.
- ♦ **4:3:** This is the default setting for a video movie or normal broadcasting.

➤ In PC Mode, only "16:9" and "4:3" mode can be adjusted.

➤ Select **[P.SIZE]** by pressing the **◀** or **▶** buttons.

Use the **▲** or **▼** button to move the picture up and down.

After selecting **[P.SIZE]**, use the **▲** or **▼** button to magnify or reduce the picture size in the vertical direction.

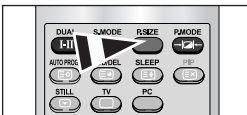

[P.SIZE] You can select these options by simply pressing the **P.SIZE** button on the remote control.

Digital Noise Reduction / Dynamic Contrast

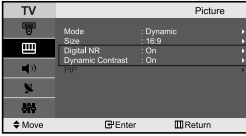

Digital NR:

If the broadcast signal received by your TV is weak, you can activate the Digital Noise Reduction feature to help reduce any static and ghosting that may appear on the screen.

Dynamic Contrast:

Dynamic Contrast detects the visual signal input and adjusts to create optimum contrast.

1. Press the **MENU** button to display the menu. Press the **▲** or **▼** button to select "Picture", then press the **ENTER** button.
2. Press the **▲** or **▼** button to select "Digital NR" or "Dynamic Contrast". Press the **ENTER** button.
3. Press the **▲** or **▼** button to select "Off" or "On". Press the **ENTER** button.
4. Press the **EXIT** button to exit.
 - These functions don't work in PC mode.

Viewing the Picture In Picture (PIP)



You can display a sub picture within the main picture of set programme or video input. In this way, you can watch the picture of set programme or video input from any connected equipment while watching the main picture.

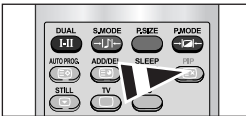

Press the **PIP** button on the remote control repeatedly to activate or deactivate the "PIP".

1. Press the **MENU** button to display the menu. Press the **▲** or **▼** button to select "Picture", then press the **ENTER** button.
2. Press the **▲** or **▼** button to select "PIP", then press the **ENTER** button.
3. Press the **ENTER** button again. Press the **▲** or **▼** button to select "On", then press **ENTER** button.
 - PIP is available only in PC mode and will be unavailable for other modes.
4. Press the **▲** or **▼** button to select "Source", then press **ENTER** button. Select a source of the sub picture by pressing the **▲** or **▼** button and press the **ENTER** button.
 - The sub picture can serve different source selections based on what the main picture is set to.
5. Press the **▲** or **▼** button to select "Position", then press the **ENTER** button. Select the position of the sub picture by pressing the **▲** or **▼** button and then press the **ENTER** button.
6. Press the **▲** or **▼** button to select "Prog." and then press the **ENTER** button. You can select the channel that you want to view through sub picture by pressing the **▲** or **▼** button. Press the **ENTER** button.
 - The "Prog." can be active when the sub picture is set to TV.
7. Press the **EXIT** button to exit.

- **Source:** Selecting a signal source (external A/V) for PIP.
- **Position:** Used to move the sub picture.
- **Prog.:** Used to Change the sub picture.

➤ PIP Settings (O: PIP operates, X: PIP doesn't operate)

Main	Sub	TV	AV1	AV2	S-Video	Component1	Component2	PC	DVI
PC		O	O	O	O	X	X	X	X

- When the main picture is PC, the sub picture only supports TV, AV and S-VIDEO. The sub picture does not support other input sources in this case.
- You may notice that the picture in the PIP window becomes slightly unnatural when you use the main screen to view a game or karaoke.

SETTING THE SOUND

Changing the Sound Standard

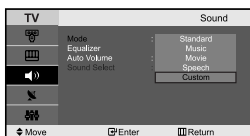

You can select the type of the special sound effect to be used when watching a given broadcast.

1. Press the **MENU** button to display the menu. Press the **▲** or **▼** button to select "Sound", then press the **ENTER** button.
2. Press the **ENTER** button again, to select "Mode".
3. Select the required sound effect by pressing the **▲** or **▼** button repeatedly and then press the **ENTER** button.
4. Press the **EXIT** button to exit.

 You can also select these options by simply pressing the **S.MODE** button on the remote control.

- **Standard:** Selects the normal sound mode.
- **Music:** Emphasizes music over voices.
- **Movie:** Provides live and full sound for movies.
- **Speech:** Emphasizes voices over other sounds.
- **Custom:** Selects your custom sound settings.

(Refer to "Adjusting the Sound Settings" on page 12)

Adjusting the Sound Settings

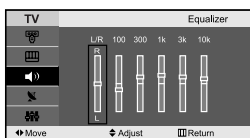

The sound settings can be adjusted to suit your personal preferences.

1. Press the **MENU** button to display the menu. Press the **▲** or **▼** button to select "Sound", then press the **ENTER** button.
2. Press the **▲** or **▼** button to select "Equalizer", then press the **ENTER** button.
3. Press the **◀** or **▶** button to select a particular item. Press the **ENTER** button.
4. Press the **▲** or **▼** button to reach the required setting. Press the **ENTER** button.
5. Press the **EXIT** button to exit.
 - If you make any changes to these settings, the Sound Mode is automatically switched to "Custom".

Adjusting the Volume Automatically

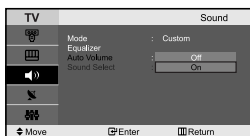

Each broadcasting station has its own signal conditions, and so it is not easy for you to adjust the volume every time the channel is changed. This feature let you automatically adjust the volume of the desired channel by lowering the sound output when the modulation signal is high or by raising the sound output when the modulation signal is low.

1. Press the **MENU** button to display the menu. Press the **▲** or **▼** button to select "Sound", then press the **ENTER** button.
2. Press the **▲** or **▼** button to select "Auto Volume", then press the **ENTER** button.
3. Press the **▲** or **▼** button to select "Off" or "On". Press the **ENTER** button.
4. Press the **EXIT** button to exit.

Listening to the Sound of the Sub Picture

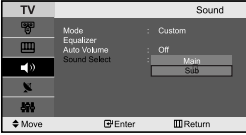

During the PIP feature is activating, you can listen to the sound of the sub picture.

1. Press the **MENU** button to display the menu. Press the **▲** or **▼** button to select "Sound", then press the **ENTER** button.
2. Press the **▲** or **▼** button to select "Sound Select", then press the **ENTER** button.
3. Press the **▲** or **▼** button to select "Sub". Press the **ENTER** button.
4. Press the **EXIT** button to exit.

- **Main:** Used to listen to the sound of the main picture.
- **Sub:** Used to listen to the sound of the sub picture.

➤ You can select this option when the "PIP" is set to "On".

SETTING THE TIME

Setting and Displaying the Current Time



You can set the TV's clock so that the current time is displayed when you press the INFO button. You must also set the time if you wish to use the automatic On/Off timers.

1. Press the **MENU** button to display the menu. Press the **▲** or **▼** button to select "Setup", then press the **ENTER** button.
2. Press the **▲** or **▼** button to select "Time", then press the **ENTER** button.
3. Press the **ENTER** button to select "Clock Set".

To...	Press the...
Move to "Hour", "Minute" or "am/pm"	◀ or ▶ button.
Set the "Hour", "Minute" or "am/pm"	▲ or ▼ button.
Press the ENTER button.	

5. Press the **EXIT** button to exit.
 - If you disconnect the power cord, you have to set the clock again.
 - You can also set hour and minute by pressing the number buttons on the remote control.

Setting the Sleep Timer

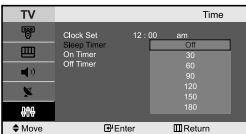

You can select a time period of between 30 and 180 minutes after which the television automatically switches to standby mode.

1. Press the **MENU** button to display the menu. Press the **▲** or **▼** button to select "Setup", then press the **ENTER** button.
2. Press the **▲** or **▼** button to select "Time", then press the **ENTER** button.
3. Press the **▲** or **▼** button to select "Sleep Timer", then press the **ENTER** button.

4. Press the **▲** or **▼** button repeatedly until the desired time appears (Off, 30, 60, 90, 120, 150, 180). Press the **ENTER** button.

5. Press the **EXIT** button to exit.

➤ The TV automatically switches to standby mode when the timer reaches 0.



Press the **SLEEP** button on the remote control repeatedly until the appropriate time interval appears.

Switching the Television On and Off Automatically

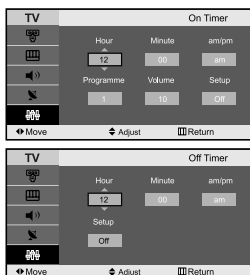

You can set the On/Off timers so that the set will:

- ◆ Switch on automatically and tune to the channel of your choice at the time you select.
- ◆ Switch off automatically at the time you select.

1. Press the **MENU** button to display the menu. Press the **▲** or **▼** button to select "Setup", then press the **ENTER** button.
2. Press the **▲** or **▼** button to select "Time", then press the **ENTER** button.
3. Press the **▲** or **▼** button to select "On Timer", then press the **ENTER** button.
4. Press the **▲** or **▼** button to adjust "Hour", then press the **▶** button to move to the next step. Set other items using the same method as above. When finished, press the **ENTER** button to return.
5. Press the **▲** or **▼** button to select "Off Timer", then press the **ENTER** button.
6. Press the **▲** or **▼** button to adjust "Hour", then press the **▶** button to move to the next step. Set other items using the same method as above. When finished, press the **ENTER** button to return.
7. Press the **EXIT** button to exit.
 - The first step is to set the television's clock.
 - You can also set hour and minute by pressing the number buttons on the remote control.
 - The "Setup" setting must be set to "On" in order for the timers to work.

SETTING THE OTHERS

Choosing Your Language



When you start using your set for the first time, you must select the language which will be used for displaying menus and indications.

1. Press the **MENU** button to display the on-screen menu. Press the **▲** or **▼** button to select "Setup", then press the **ENTER** button.
2. Press the **▲** or **▼** button to select "Language", then press the **ENTER** button.
3. Select a particular language by pressing the **▲** or **▼** button repeatedly. Press the **ENTER** button.
 - You can choose one of 4 languages.
4. Press the **EXIT** button to exit.

Using the Energy Saving Feature

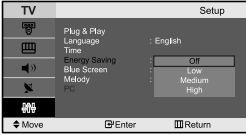

This feature adjusts the brightness of TV so as to reduce the power consumption. When you watching TV at night, set the "Energy Saving" mode option to "High" so as to reduce the dazzling of your eyes as well as the power consumption.

1. Press the **MENU** button to display the on-screen menu. Press the **▲** or **▼** button to select "Setup", then press the **ENTER** button.
2. Press the **▲** or **▼** button to select "Energy Saving", then press the **ENTER** button.
3. Select the required option (Off, Low, Medium, High) by pressing the **▲** or **▼** button. Press the **ENTER** button.
4. Press the **EXIT** button to exit.
 - This function does not work in PC mode.

Setting the Blue Screen Mode / Selecting the Melody

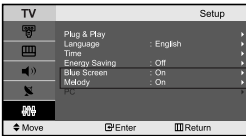

Blue Screen:

If no signal is being received or the signal is very weak, a blue screen automatically replaces the noisy picture background. If you wish to continue viewing the poor picture, you must set the "Blue Screen" mode to "Off".

Melody:

You can hear melody sound when the television is powered on or off.

1. Press the **MENU** button to display the menu. Press the **▲** or **▼** button to select "Setup", then press the **ENTER** button.
2. Press the **▲** or **▼** button to select "Blue Screen" or "Melody". Press the **ENTER** button.
3. Press the **▲** or **▼** button to select "Off" or "On". Press the **ENTER** button.
4. Press the **EXIT** button to exit.

Selecting the Source

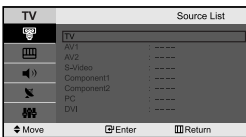

You can select among external sources connected to your TV's input jacks.

1. Press the **MENU** button to display the menu. Press the **ENTER** button, to select "Input".
2. Press the **ENTER** button again, to select "Source List".
 - When no external device is connected to your set, only "TV" are activated in the "Source List". "AV1", "AV1", "S-Video", "Component1", "Component2", "PC", "DVI" are activated only when they are connected to your set.
3. Select the required device by pressing the **▲** or **▼** button. Press the **ENTER** button.

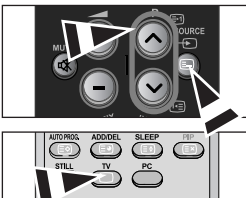

- Press the **SOURCE** button on the remote control to toggle between all the available source. TV mode can be selected by pressing the **TV** or **P** button on the remote control but you cannot select it by pressing the **SOURCE** button.

Editing the Input Source Names

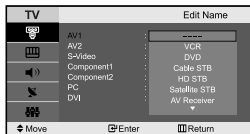

Name the device connected to the input jacks to make your input source selection easier.

1. Press the **MENU** button to display the menu.
Press the **ENTER** button, to select "Input".
2. Press the **▲** or **▼** button to select "Edit Name", then press the **ENTER** button.
3. Press the **▲** or **▼** button to select the device that you wish to edit.
Press the **ENTER** button.
4. Press the **▲** or **▼** button to select the required device.
Press the **ENTER** button.
5. Press the **EXIT** button to exit.

USING THE TELETEXT FEATURE

Teletext Decoder

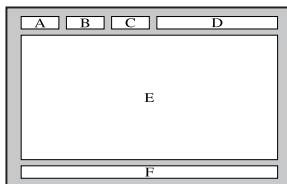

Most set channels carry " teletext ", pages of written information that provide information such as:

- ◆ **Television programme times.**
- ◆ **News bulletins and Weather forecasts.**
- ◆ **Sports results.**
- ◆ **Subtitles for the hard of hearing.**

The teletext pages are organized according to six categories:

Part	Contents
A	Selected page number.
B	Broadcasting station identity.
C	Current page number or search status.
D	Date and time.
E	Text.
F	Status information.

Displaying the Teletext Information

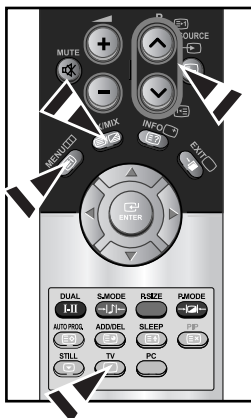

You can display teletext information at any time, but signal reception must be good. Otherwise:

- ◆ Information may be missing.
- ◆ Some pages may not be displayed.

To activate the teletext mode and display the contents page:

1. Using the **P** () or **P** () button, select the channel providing the teletext service.
2. Press the **TTX/MIX** () button to activate the teletext mode.
 - The contents page is displayed. It can be redisplayed at any time by pressing the **MENU** () button.
3. Press the **TTX/MIX** () button again.
 - The actual broadcast will be displayed simultaneously with the teletext page on the screen.
4. Press the **TV** () button again to exit from the Text display.
 - If any broken character appears while Text is being viewed, make sure that the Text language is identical with the language in the "Setup" menu mode. If both languages are different, select the same language with the Text language on the "Setup" menu.

Selecting a Specific Teletext Page



Press the number buttons on the remote control to enter the page number directly:

1. Enter the three-digit page number listed in the contents by pressing the corresponding numeric buttons.
2. If the selected page is linked with several secondary pages, the secondary pages are displayed in sequence. To freeze the display on a given page, press the **-/-** () button again to resume.
3. Using the various display options:

To display...	Press the...
Both teletext information and the normal broadcast	TTX/MIX ()
Hidden text (answers to quiz games, for example)	INFO ()
The normal screen	INFO ()
A secondary page, by entering its 4-digit number	ADD/DEL ()
The next page	P ()
The previous page	P ()
Double-size letters in the: <ul style="list-style-type: none"> • Upper half of the screen • Lower half of the screen 	SLEEP () <ul style="list-style-type: none"> • Once • Twice
Normal screen	• Three times

Using Fastext to Select a Teletext Page

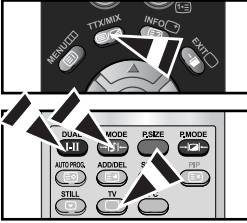

The various topics included in the teletext pages are colour-coded, and can be selected by pressing the coloured buttons on the remote control.

1. Display the teletext contents page by pressing the TTX/MIX () button.
2. Press the coloured button corresponding to the topic that you wish to select (The available topics are listed on the status information line).
3. Press the Red button to display the previous page. Press the Green button to display the next page.
4. Press the TV () button again to exit from the Text display.

SETTING THE PC

Setting up Your PC Software (Based on Windows XP)

The Windows display-settings for a typical computer are shown below. The actual screens on your PC may be different depending upon your particular version of Windows and your particular video card. Even if your actual screens look different, the same, basic set-up information will apply in almost all cases. (If not, contact your computer manufacturer or Samsung Dealer.)



1. First, click on "Control Panel" on the Windows start menu.
2. When the control panel window appears, click on "Appearance and Themes" and a display dialog-box will appear.
3. When the control panel window appears, click on "Display" and a display dialog-box will appear.
4. Navigate to the "Settings" tab on the display dialog-box.

The correct size setting (resolution): Optimum- 1360 X 768

If a vertical-frequency option exists on your display settings dialog box, the correct value is "60" or "60 Hz". Otherwise, just click "OK" and exit the dialog box.

Display Modes

Both screen position and size will vary depending on the type of PC monitor and its resolution.

The resolutions in the table are recommended. (All resolutions between the supported limits are supported)

Mode	Resolution	Horizontal Frequency (kHz)	Vertical Frequency (Hz)	Pixel Clock Frequency (MHz)	Sync Polarity (H/V)
IBM	640 x 480	31.469	59.940	25.175	- / -
	720 x 400	31.469	70.087	28.322	- / +
VESA	640 x 480	37.861	72.809	31.500	- / -
	640 x 480	37.500	75.000	31.500	- / -
	800 x 600	37.879	60.317	40.000	+ / +
	800 x 600	48.077	72.188	50.000	+ / +
	800 x 600	46.875	75.000	49.500	+ / +
	1024 x 768	48.364	60.000	65.000	- / -
	1024 x 768	56.476	70.069	75.000	- / -
	1024 x 768	60.023	75.029	78.750	+ / +
	1360 x 768	47.712	60.015	85.800	+ / +

- > The interlace mode is not supported.
- > The set might operate abnormally if a non-standard video format is selected.
- > DVI does not support PC function.
- > Separate and Composite modes are supported. SOG is not supported.

Setting the PC

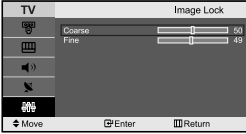

Coarse and Fine Tuning of the Image (Image Lock):

The purpose of picture quality adjustment is to remove or reduce picture noise. If the noise is not removed by Fine-tuning alone, then adjust the frequency as best as possible (coarse) and Fine-tune again. After the noise has been reduced, re-adjust the picture so that it is aligned on the center of screen.



Press the **PC** button on the remote control to select the PC mode.

1. Preset: Press the **PC** button to select PC mode.
2. Press the **MENU** button to display the menu. Press the **▲** or **▼** button to select "Setup", then press the **ENTER** button.
3. Press the **▲** or **▼** button to select "PC", then press the **ENTER** button.
4. Press the **ENTER** button to select "Image Lock".
5. Press the **▲** or **▼** button to select "Coarse" or "Fine", then press the **ENTER** button.
6. Press the **◀** or **▶** button to adjust the screen quality. Press the **ENTER** button.
7. Press the **EXIT** button to exit.

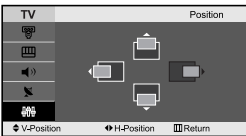

Changing the Image Position (Position):

Adjust the PC's screen positioning if it does not fit the TV screen.

1. Follow the "Coarse and Fine Tuning of the Image (Image Lock)" instructions number 1 to 3.
2. Press the **▲** or **▼** button to select "Position", then press the **ENTER** button.
3. Press the **▲** or **▼** button to adjusting the Vertical-Position. Press the **◀** or **▶** button to adjust the Horizontal-Position. Press the **ENTER** button.
4. Press the **EXIT** button to exit.

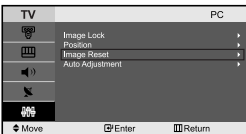

Initializing the Image Settings (Image Reset):

You can replace all image settings with the factory default values.

1. Follow the "Coarse and Fine Tuning of the Image (Image Lock)" instructions number 1 to 3.
2. Press the **▲** or **▼** button to select "Image Reset", then press the **ENTER** button.
3. Press the **EXIT** button to exit.

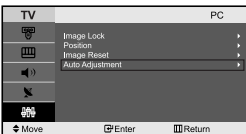



Adjusting the PC Screen Automatically (Auto Adjustment):

Auto adjustment allows the PC screen of set to self-adjust to the incoming PC video signal. The values of fine, coarse and position are adjusted automatically.

1. Follow the "Coarse and Fine Tuning of the Image (Image Lock)" instructions number 1 to 3.
2. Press the **▲** or **▼** button to select "Auto Adjustment", then press the **ENTER** button.
3. Press the **EXIT** button to exit.

RECOMMENDATIONS FOR USE

Troubleshooting: Before Contacting Service Personnel

No sound or picture	<ul style="list-style-type: none"> • Check that the mains lead has been connected to a wall socket. • Check that you have pressed the POWER  buttons on the front of the set. • Check the picture contrast and brightness settings. • Check the volume.
Normal picture but no sound	<ul style="list-style-type: none"> • Check the volume. • Check whether the MUTE  button has been pressed on the remote control.
No picture or black and white picture	<ul style="list-style-type: none"> • Adjust the colour settings. • Check that the broadcast system selected is correct.
Sound and picture interference	<ul style="list-style-type: none"> • Try to identify the electrical appliance that is affecting the set and move it further away. • Plug your set into a different mains socket.
Blurred or snowy picture, distorted sound	<ul style="list-style-type: none"> • Check the direction, location and connections of your aerial. This interference is often due to the use of an indoor aerial.
Remote control malfunctions	<ul style="list-style-type: none"> • Replace the remote control batteries. • Clean the upper edge of the remote control (transmission window). • Check the battery terminals.
"Check signal cable." message is displayed.	<ul style="list-style-type: none"> • Check that the signal cable is firmly connected to the PC or video sources. • Check that the PC or video sources are turned on.
On PC mode, "Mode Not Supported." message is displayed.	<ul style="list-style-type: none"> • Check the maximum resolution and the frequency of the video adaptor. • Compare these values with the data in the Display Modes.

The TFT LCD panel uses a panel consisting of sub pixels (3,133,440) which require sophisticated technology to produce. However, there may be few bright or dark pixels on the screen. These pixels will have no impact on the performance of the product.

Technical and Environmental Specifications

Model Name	LA27T51B	LA32T51B
Panel		
Size	27" Diagonal (16:9)	32" Diagonal (16:9)
Display Size	603.22 (H) x 341.98 (V) mm	697.68 (H) x 392.26 (V) mm
Pixel Pitch	0.1460 (H) x 0.4365 (V) mm	0.51075 (H) x 0.51075 (V) mm
Frequency		
Horizontal / Vertical	30~61 kHz / 60~75 Hz	30~61 kHz / 60~75 Hz
PC Resolution (Optimum)	1360 x 768 @ 60 Hz	1360 x 768 @ 60 Hz
Power Supply (Input)	AC100-240V±10% ~ 60/50 Hz	AC100-240V±10% ~ 60/50 Hz
Power Consumption		
Normal / Power Saving	140 W / < 2.0 W	170 W / < 2.0 W
Dimension (WxDxH)		
Body	766.5 x 96.0 x 459.0 mm	914.5 x 104.0 x 528.8 mm
With stand	766.5 x 203.8 x 505.5 mm	914.5 x 247.5 x 591.5 mm
Weight		
With stand	12.0 kg (26.46 lbs)	15.0 kg (33.07 lbs)
Environmental Considerations		
Operating Temperature	10 °C to 40 °C (50 °F to 104 °F)	10 °C to 40 °C (50 °F to 104 °F)
Operating Humidity	10 % to 80 %, non-condensing	10 % to 80 %, non-condensing
Storage Temperature	-20 °C to 45 °C (-4 °F to 113 °F)	-20 °C to 45 °C (-4 °F to 113 °F)
Storage Humidity	5 % to 95 %, non-condensing	5 % to 95 %, non-condensing
Sound		
Output	5 W X 2	7.5 W X 2

➤ Design and specifications are subject to change without prior notice.

MEMO



MEMO

