

**SINGER**  
**114W110**

1595w

INSTRUCTIONS  
FOR USING  
SINGER BRAIDING MACHINE

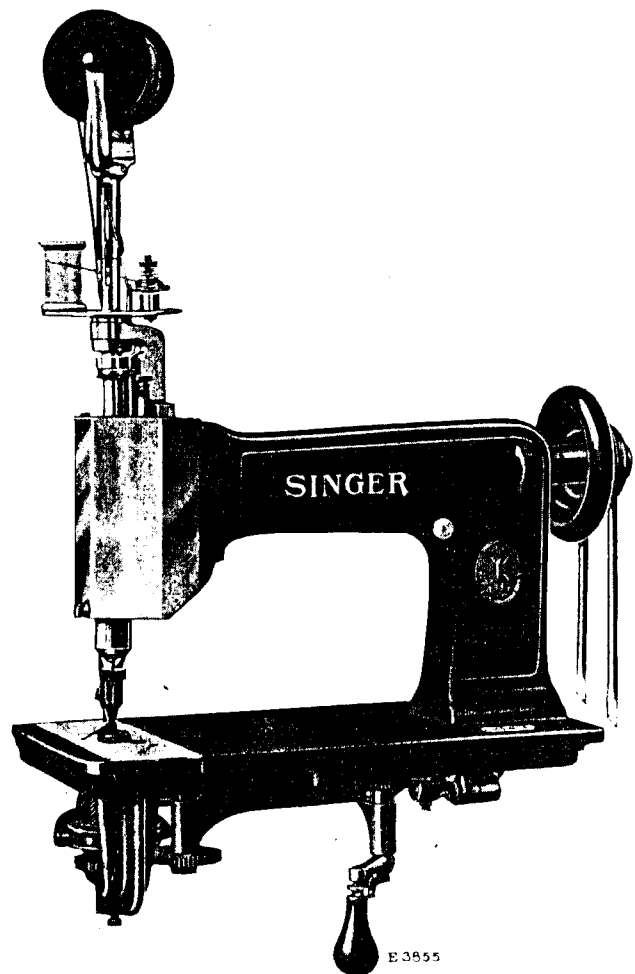

114w110

THE SINGER MANUFACTURING CO.

## DESCRIPTION

Machine 114 w 110 is designed for sewing braid on waists, cloaks, suits, dresses, skirts, robes, opera wraps, uniforms, millinery goods and a great variety of other articles such as curtains, table covers, mantel scarfs, etc., all of which are made very attractive by the ornamental designs produced by the machine. Fabrics, including fine chiffon, georgette, china silk, net and similar sheer materials, also the heavier fabrics such as broad cloth, velvet, etc., are stitched with equal satisfaction by the machine.

The braid can be sewn "flat on," or it can be sewn "edge on" for what is known as "standing" braid. When the machine is used for sewing the braid "flat on," the invisible lock stitch is made, the stitches being placed in the centre on the underside of the braid. When the braid is sewn "edge on," one of the edges of the braid stands upward, producing artistic effects different from those obtained when the braid is stitched on flat. (See pages 18 and 20).

The braid is taken from a spool located at the top of the machine, and passed down through a tube to a suitable guide which conducts it to the needle in the desired position for stitching. Braid guides can be furnished for various descriptions of braids as shown on page 15, and samples of the braid to be used should accompany orders for guides.

The usual method for sewing on the braid is to follow a pattern that has been stamped or traced upon the fabric. With a little practice the operator can produce ornamental designs without the aid of patterns.

The machine has one needle and one oscillating shuttle.

## Speed

The speed of the machine is limited only by the skill of the operator. The machine should be started at a speed of about 600 stitches per minute and this speed can be increased when the operator becomes proficient and the nature of the work permits. When the machine is in operation the balance wheel should always turn over from the operator.

## To Oil the Machine

When the machine is received from the factory it should be thoroughly cleaned and oiled.

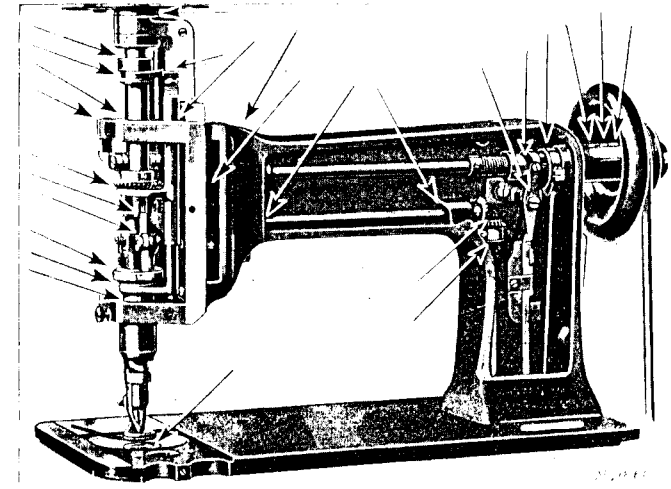

FIG. 2. OILING POINTS AT THE FRONT OF THE MACHINE

To clean the machine, use a little kerosene at the oiling points shown in Figs. 2, 3, 4 and 5, run the machine rapidly for one minute then wipe clean.

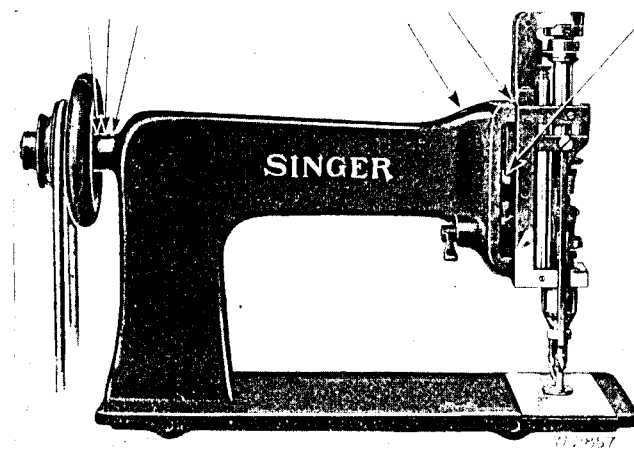

FIG. 3. OILING POINTS AT THE BACK OF THE MACHINE

Oil should then be applied at each of the places designated by arrows in Figs. 2, 3, 4 and 5. When the machine is in continuous use it should be oiled at least once each day.

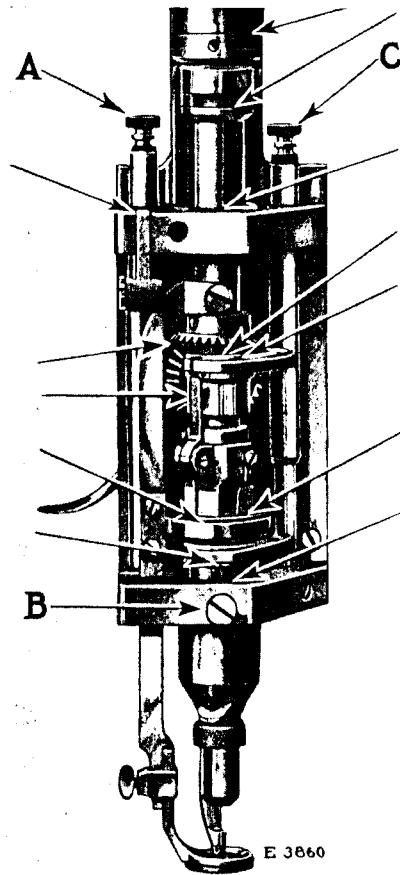

FIG. 4. END VIEW OF THE MACHINE, SHOWING OILING POINTS

Fig. 2 shows the front plate of the machine removed for the purpose of cleaning and oiling. The front plate can be removed after taking out the thumb screw which holds it in position.

Fig. 4, above, shows the face plate of the machine removed for the purpose of cleaning and oiling. The face plate can be removed after loosening the thumb screw (B, Fig. 4).

Turn the machine back on its hinges and apply oil at the places shown by arrows in Fig. 5 and all other places where

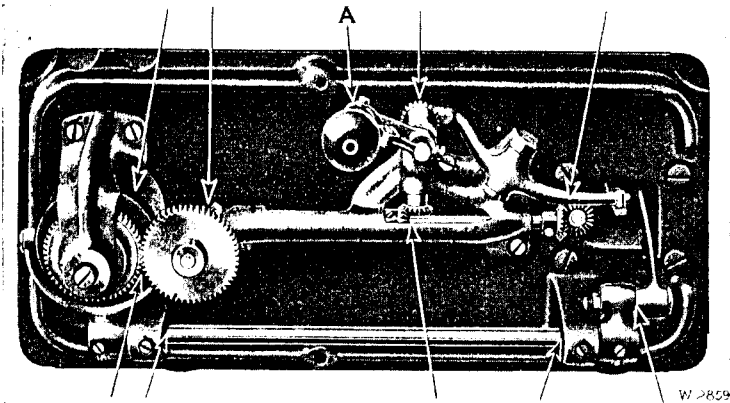

FIG. 5. OILING POINTS IN THE BASE OF THE MACHINE

there are parts in movable contact, then bring the machine forward into place.

### Needles

Needles for Machine 114 w 110 are of Class and Variety 126 x 1 and are made in sizes Nos. 8, 9, 10, 12, 14, 16, 18, 20, 22, 23, 24 and 25.

The size of the needle to be used should be determined by the size of the thread which must pass freely through the eye of the needle. If rough or uneven thread is used the successful operation of the machine will be interfered with.

Orders for needles must specify the quantity required, the size number, also the class and variety numbers separated by the letter x.

The following is an example of an intelligible order:

“100 No. 12, 126 x 1 Needles.”

The best results will be obtained in using the needles furnished by the Singer Sewing Machine Company.

## Thread

Left twist thread should be used in the needle. Either right or left twist thread can be used in the bobbin.

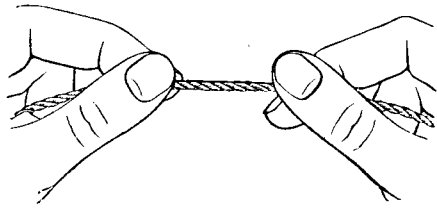

FIG. 6. HOW TO DETERMINE THE TWIST

Hold the thread as shown above. Turn the thread over toward you between the thumb and forefinger of the right hand; if right twist, the strands will unwind; if left twist, the strands will wind tighter.

## To Remove the Bobbin

(SEE FIG. 7)

Turn the balance wheel over from you until the needle bar moves up to its highest point. Place the thumb of the left hand

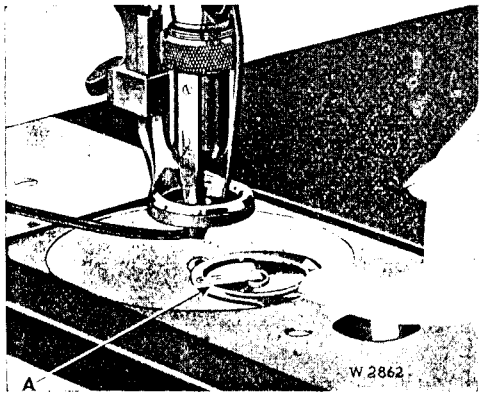

FIG. 7. REMOVING THE SHUTTLE

under the front edge of the needle plate; raise the plate upward and draw it toward you to remove it from the machine.

Insert the finger nail of the forefinger of the right hand in the notch in the side of the shuttle, as shown in Fig. 7, and lift out the shuttle. Then raise the tension latch (A, Fig. 7) on the shuttle, turn the open end of the shuttle downward and the bobbin will drop out.

## To Wind the Bobbin

(SEE FIG. 8)

Fasten the bobbin winder to the table with its driving pulley in the front of the machine belt so that the pulley will drop away from the belt when sufficient thread has been wound upon the bobbin.

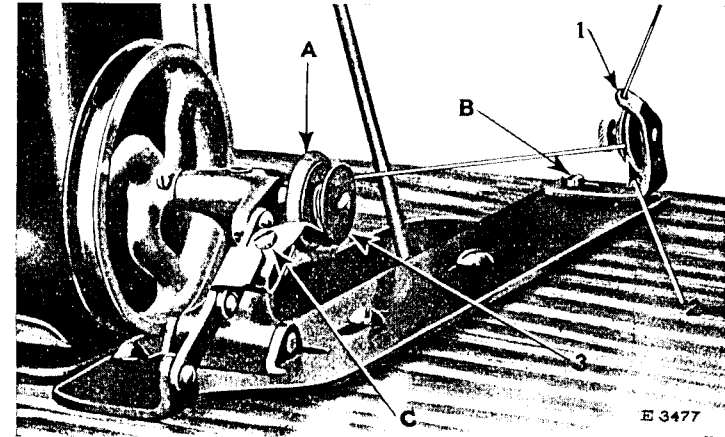

FIG. 8. WINDING THE BOBBIN

Pass the thread down through the thread guide (1) in the tension bracket, around the back and between the tension discs (2).

Having placed the bobbin on the bobbin winder spindle, pass the end of the thread between the bobbin (3) and the disc (A) on the spindle, then push the bobbin up closely against the disc, and the end of the thread will be retained between the bobbin and the disc. With the left hand hold the bobbin winder pulley, and at the same time, with the right hand, turn the bobbin and the disc on the bobbin winder spindle over toward you to expand the spindle, thus securing the bobbin. Then push the bobbin winder pulley over against the machine belt, and start the machine.

If the thread does not wind evenly on the bobbin, loosen the screw (B) in the tension bracket and move the bracket to the right or left as may be required, then tighten the screw.

When sufficient thread has been wound upon the bobbin, the bobbin winder will stop automatically. To release the bobbin, turn the disc on the spindle over from you, then cut the tail thread off inside of the bobbin and the thread leading from the spool, and remove the bobbin.

The amount of thread wound on the bobbin is regulated by the screw (C). To wind more thread on the bobbin turn the screw (C) inwardly. To wind less thread on the bobbin, turn the screw outwardly.

Bobbins can be wound while the machine is stitching.

### To Thread the Shuttle

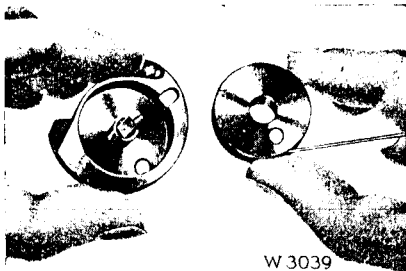

FIG. 9

Hold the bobbin between the thumb and forefinger of the right hand, as shown in Fig. 9, the thread drawing from the underside from the left toward the right.

With the left hand hold the shuttle as shown in Fig. 9, and place the bobbin into it.

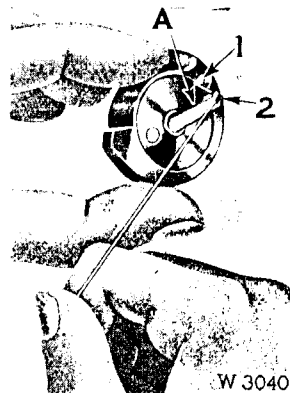

FIG. 10

Draw the thread into the notch (1, Fig. 10) in the upper edge of the shuttle, then pass the thread into slot (2, Fig. 10) in the end of the shuttle latch (A, Fig. 10) and at the same time close the latch as shown in Fig. 11.



FIG. 11

### To Replace the Shuttle

(SEE FIGS. 12, 13 AND 14)

After threading the shuttle, turn the handle (A, Fig. 5, page 5) to the right to bring the two upwardly projecting studs of the

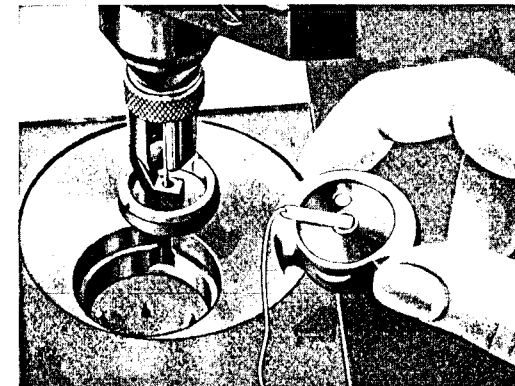

FIG. 12. REPLACING THE SHUTTLE

shuttle driver to the front, then holding the shuttle between the thumb and forefinger of the right hand, as shown in Fig. 12, place it into position in the machine as shown in Fig. 13, with the thread drawing off from the top. Lay the thread back over the back plate in the bed of the machine. The front edge of the

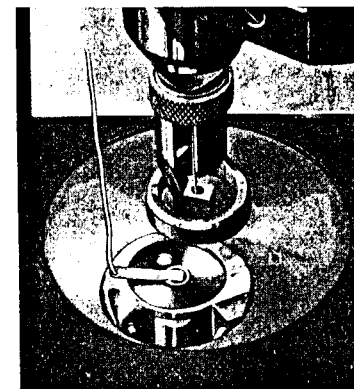

FIG. 13. SHUTTLE THREADED AND REPLACED

back plate has a cutting edge. Replace the needle plate and by drawing the thread backwards, as shown in Fig. 14, the thread will be cut the correct length.

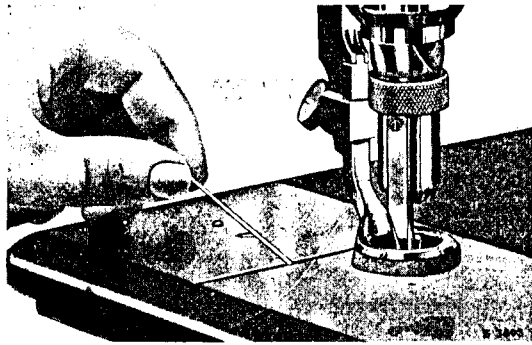

FIG. 14. UNDER THREADING COMPLETED

### To Thread the Needle

(SEE FIGS. 15 AND 16)

Turn the handle (A, Fig. 5, page 5) until it is toward the front of the machine. Place the spool of thread on the spool pin

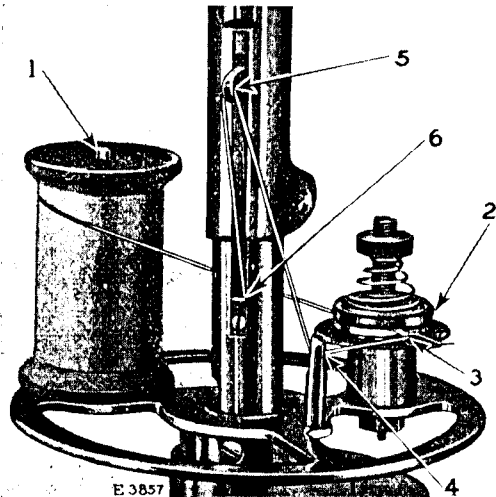

FIG. 15. THREADING THE NEEDLE

(1, Fig. 15) and pass the thread from the spool around the back from left to right between the tension discs (2, Fig. 15) into the thread controlling spring (3, Fig. 15) then through the thread guide (4, Fig. 15) and through the **small hole (5, Fig. 15) in the end of the take-up lever.** Draw about 10 inches of thread

through the take-up lever or enough to reach the needle, then insert the threading wire (A, Fig. 16) in the upper end of the

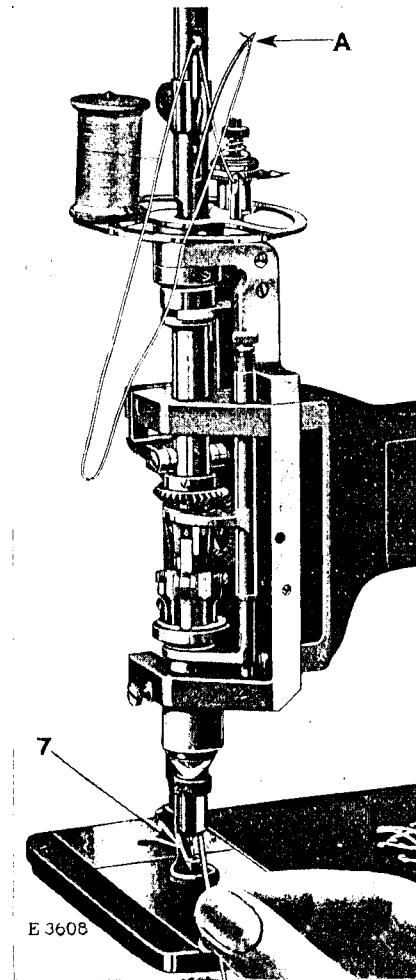

FIG. 16. THREADING THE NEEDLE

hollow needle bar (6, Fig. 15). Pass the wire down until the lower end strikes the needle plate. Then hook the upper end of the wire to the thread, as shown in Fig. 16, and draw the wire and thread down through the hollow needle bar (6, Fig. 15) then pass the thread from right to left through the eye of the needle (7, Fig. 16).

### To Draw Up the Bobbin Thread

(SEE FIG. 17)

Lower the presser foot. With the left hand hold the end of the needle thread, leaving it slack from the hand to the needle. Turn

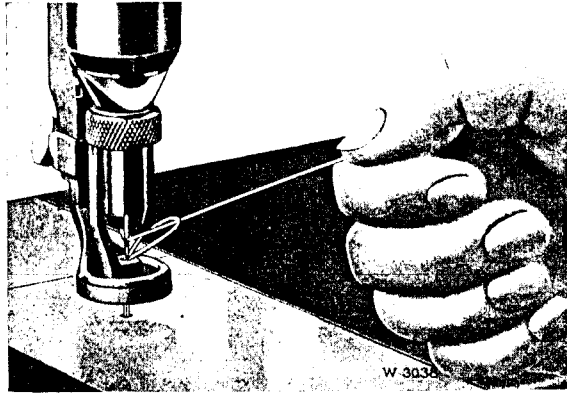

FIG. 17. DRAWING UP THE BOBBIN THREAD

the balance wheel over from you until the needle moves down and up again to its highest point, thus catching the bobbin thread. Draw up the needle thread and the bobbin thread will come up with it through the hole in the needle plate as shown in Fig. 17. Lay both threads back under the presser foot.

### To Set the Needle

Turn the handle (A, Fig. 5, page 5) toward the front of the machine, then turn the balance wheel over from you until the needle set screw is at its highest visible point; loosen the set screw and put the needle up into the needle bar as far as it will go with the long groove of the needle toward the right, then tighten the set screw.

### Learning to Operate the Machine

(SEE FIGS. 18 AND 19)

When the machine is set up on table No. 205348 and foot power stand No. 25267, place the feet securely on the treadle and with the right hand turn the balance wheel over from you. Continue the motion by an alternate pressure of heel and toe on the treadle. This motion should be practiced until the balance wheel can be kept in continuous rotation by the feet alone.

It is important to acquire the habit of turning the balance wheel over from you, otherwise the machine will not form stitches.

When the machine is mounted on a power table, care should be taken to see that the balance wheel on the machine turns over from the operator.

Having secured a piece of cloth about 12 inches square, mark upon it a design similar to the one shown in Fig. 18, then place the

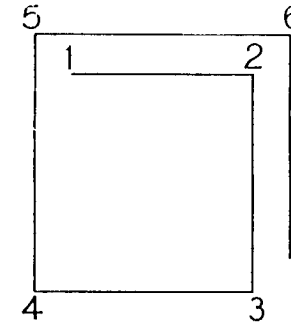

FIG. 18. DIAGRAM FOR PRACTICE

cloth under the presser foot so that the needle will enter the end of the line marked 1 and turn the handle (A, Fig. 5, page 5) to the right. Lower the presser foot, start the balance wheel in motion by turning it over from you, grasp handle A and pull it downward to start the machine. The piece of cloth will be fed along towards the left and when the end of the line at 2 is reached, still depress the handle and turn it directly towards the front. The piece of cloth will then be fed towards the back of the machine. When the point 3 is reached still depress the handle and turn it straight to the left when the cloth will be fed until the point 4 is reached. This process should be continued to the point 5, thence to the point 6, and the diagram will then be completed by manipulating the handle A without turning the cloth with the hands.

The operator should next practice embroidering designs similar to those illustrated in Fig. 19 below:



FIG. 19. DESIGNS FOR BEGINNERS

These designs can be sketched on white goods, such as lawn, and the operator by following them can become proficient in this way to attempt the embroidering of more intricate designs or patterns.



**Braiding Hints**

When braiding net, georgette crepe, chiffon and light weight materials generally, a backing is necessary to prevent puckering of the goods, and for this purpose chemically treated crinoline is used, this crinoline being afterwards removed by placing the work in a warm oven or by the application of a hot iron. Chemically treated crinoline can be purchased from dealers ready for use or the mixture for the chemical treatment of crinoline can be prepared as follows:

**Receipe for Making the Chemical Mixture:**

Dissolve one cup of dry lump starch in cold water, then add sufficient boiling water to make thin starch water and add 2 ounces of sulphuric acid. Let cool. Having secured a piece of crinoline (about 24 yards) fold it to fit the basin and place it in the starch water, leaving it stand for one hour. Then take out the crinoline and hang it up to dry. It is then ready for use.

**Method of Stamping**

In a majority of cases where chemically treated crinoline is used as a backing for sheer materials, the embroidery design is stamped on the crinoline. This stamping is done by spreading with a poncette, previously saturated with benzine, regular embroiderer's paste over the perforated pattern which is placed, right side up, over the crinoline. The material to be braided is then placed over the stamped crinoline, and as the embroidery design can be seen through the material, it is easily followed by the operator. After the braid is sewn on, the crinoline is removed by placing it in a small oven or by applying a hot iron to it. The heat causes the crinoline to crumple into a powder so that there is no trace of the backing left, and the braid and material remain uninjured.

When braiding broad cloth, Bolivia cloth, serge, velvet and other similar fabrics, no backing is required and the embroidery design is usually stamped on the face of the material, the best results being obtained by this method. The stamping of the embroidery design is done, in most cases, with powder which can be procured from embroidery dealers, or, if desired, can be quickly prepared as follows:

**Receipe for Making Stamping Powder:**

Put one cup of zinc white,  $\frac{3}{4}$  cup of powdered resin and  $\frac{1}{4}$  cup of talcum in a basin and mix thoroughly, then sift through a fine cloth. It is then ready for use.

**Method of Stamping**

The powder is spread by means of a poncette over the perforated pattern which is placed, wrong side up, on the face of the fabric to be braided. When the pattern is removed, the embroidery design is clearly shown on the fabric. The braid is then sewn over the stamped design, so that none of the marking is visible when the work is finished.

**Braid Guides for Machine 114 w 110**

**For Stitching Braid "Flat on"**

NO.	SIZE	THICKNESS	
231626	$\frac{3}{64}$ in.	A to C	
231627	$\frac{1}{16}$ in.	A to D	
231628	$\frac{5}{64}$ in.	A to E	Sent regularly with machine
231629	$\frac{3}{32}$ in.	A to F	" " " "
231630	$\frac{7}{64}$ in.	A to G	
231631	$\frac{1}{8}$ in.	A to H	Sent regularly with machine
231632	$\frac{9}{64}$ in.	A to K	
231633	$\frac{5}{32}$ in.	A to L	
231634	$\frac{11}{64}$ in.	A to M	
231635	$\frac{3}{16}$ in.	A to N	

Braid Guides for stitching braid "flat on" are made for various thicknesses of braid. The thickness of the braid is designated by letters as follows, which must be used in ordering braid guides:

A — up to $\frac{1}{64}$ in.	E — $\frac{1}{16}$ to $\frac{5}{64}$ in.	K — $\frac{1}{8}$ to $\frac{9}{64}$ in.
B — $\frac{1}{64}$ to $\frac{1}{32}$ in.	F — $\frac{5}{64}$ to $\frac{3}{32}$ in.	L — $\frac{9}{64}$ to $\frac{11}{32}$ in.
C — $\frac{1}{32}$ to $\frac{3}{64}$ in.	G — $\frac{3}{32}$ to $\frac{7}{64}$ in.	M — $\frac{11}{32}$ to $\frac{13}{64}$ in.
D — $\frac{3}{64}$ to $\frac{1}{16}$ in.	H — $\frac{7}{64}$ to $\frac{1}{8}$ in.	N — $\frac{13}{64}$ to $\frac{3}{16}$ in.

**For Stitching Braid "Edge on"**

NO.	SIZE	
231616	$\frac{3}{64}$ in.	
231617	$\frac{1}{16}$ in.	
231618	$\frac{5}{64}$ in.	Sent regularly with machine
231619	$\frac{3}{32}$ in.	" " " "
231620	$\frac{7}{64}$ in.	
231621	$\frac{1}{8}$ in.	Sent regularly with machine
231622	$\frac{9}{64}$ in.	
231623	$\frac{5}{32}$ in.	
231624	$\frac{11}{64}$ in.	
231625	$\frac{3}{16}$ in.	

**For Stitching Round Braid**

NO.	SIZE	
231636	$\frac{1}{64}$ in.	
231637	$\frac{1}{32}$ in.	
231638	$\frac{3}{64}$ in.	
231639	$\frac{1}{16}$ in.	Sent regularly with machine
231640	$\frac{3}{16}$ in.	" " " "
231641	$\frac{1}{8}$ in.	
231642	$\frac{3}{16}$ in.	
231643	$\frac{1}{8}$ in.	
231644	$\frac{9}{64}$ in.	Sent regularly with machine
231645	$\frac{5}{32}$ in.	

### To Remove and Replace the Braid Guide

(SEE FIG. 20)

Turn the knurled ring (D, Fig. 20) over to the right or upward as far as it will go, then pull out the braid guide (B, Fig. 20) to remove it from the machine.

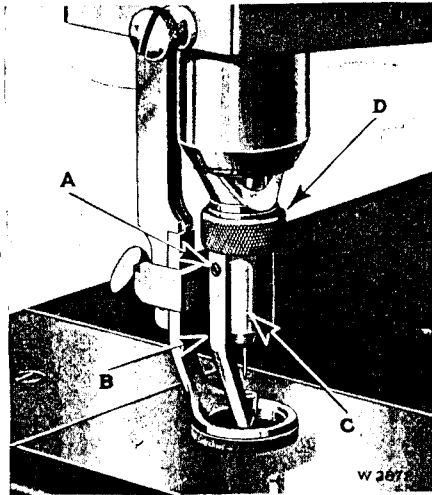

FIG. 20. BRAID GUIDE IN POSITION IN LEFT GROOVE OF BRAID GUIDE CARRIER

There are two grooves in the braid guide carrier (C, Fig. 20) and in replacing the braid guide care should be taken to see that the guide is placed in the correct groove. To determine the correct groove, turn the handle (A, Fig. 5, page 5) toward the front of the machine. The groove at the back of the carrier should be used when sewing the braid "flat on" with invisible stitches. The groove at the left of the carrier should be used when stitching the braid "edge on" for what is known as "standing" braid and when stitching round braid.

Having placed the braid guide into the correct groove in the carrier, see that the small pin on the guide enters the hole in the groove, then turn the knurled ring (D) over to the left or downward as far as it will go to fasten the guide securely in position.

### To Sew Braid "Flat on" with Invisible Stitches

(SEE FIG. 21)

Select the braid guide according to the size of braid to be used and place it in the **back groove in the braid guide carrier** as instructed on page 16.

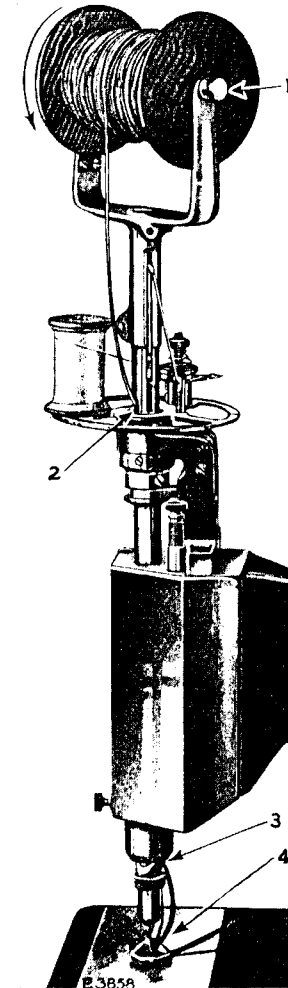

FIG. 21. THREADING BRAID FOR SEWING BRAID "FLAT ON" WITH INVISIBLE STITCHES

Place the spool of braid on the spool pin (1, Fig. 21) and place it in the machine with the large end of the spool pin towards you when the handle (A, Fig. 5, page 5) is towards the front.

When the braid is taken from the spool, the spool should turn in the direction indicated by the arrow in Fig. 21. Then with the threading wire furnished with the machine pass the braid down through the opening (2, Fig. 21) of the hollow tube so that it will be fed through the rear opening (3, Fig. 21) in the braid guide carrier, then pass the braid from back to front through the hole in the braid guide (4, Fig. 21) and draw it back under the presser foot. For stitching, follow the instructions given on pages 12 and 13.

### To Adjust the Braid Guide for Sewing Braid "Flat on" with Invisible Stitches

(SEE FIGS. 20 AND 22)

If it is found that the needle does not enter the braid properly after the braid is threaded through the braid guide, loosen the

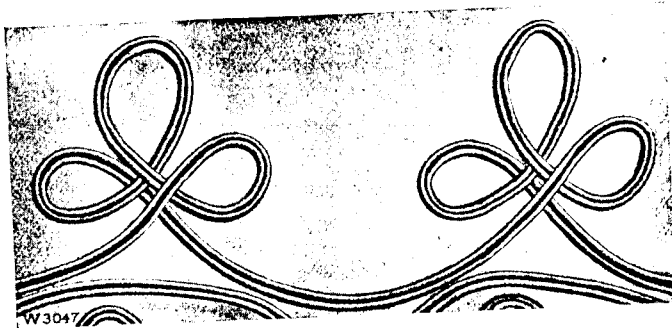

FIG. 22. BRAID SEWN "FLAT ON" WITH INVISIBLE STITCHES

knurled ring (D, Fig. 20, page 16) and slightly loosen the small set screw (A, Fig. 20) in the braid guide to bring the guide closer to the needle. The braid guide should be set so that the needle just enters the braid at every stitch. When the braid guide has been properly adjusted tighten the knurled ring (D).

### To Sew the Braid "Edge on" for "Standing" Braid Also to Sew on Round Braid

(SEE FIG. 23)

Select the braid guide according to the size of braid to be sewn and place it in the groove at the left of the braid guide carrier as instructed on page 16.

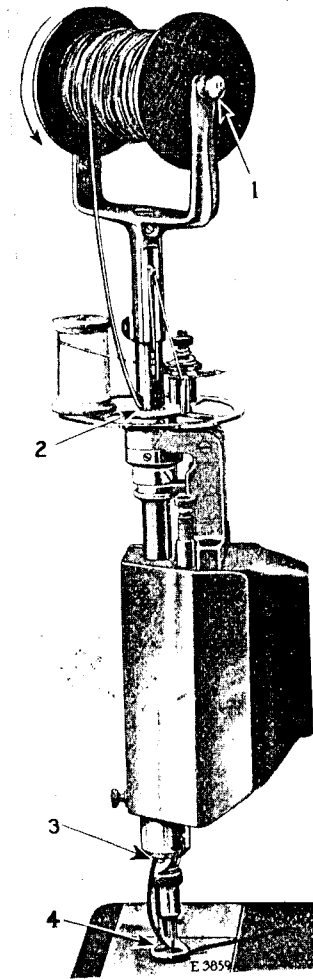

FIG. 23. THREADING BRAID FOR SEWING THE BRAID "EDGE ON" FOR "STANDING" BRAID, ALSO FOR SEWING ON ROUND BRAID

Place the spool of braid on the spool pin (1, Fig. 23, page 19) and place it in the machine with the large end of the spool pin towards you when the handle (A, Fig. 5, page 5) is towards the front. When the braid is taken from the spool, the spool should turn in the direction indicated by the arrow in Fig. 23. Then with the threading wire furnished with the machine pass the braid down through the opening (2, Fig. 23) of the hollow tube so that it will be fed through the front opening (3, Fig. 23) in the braid guide carrier, then pass the braid from front to back through the lower hole in the braid guide (4, Fig. 23) and draw it back under the presser foot. For stitching, follow the instructions given on pages 12 and 13.

**To Adjust the Braid Guide for Sewing the Braid  
"Edge on" for "Standing" Braid  
Also for Sewing on Round Braid**

(SEE FIGS. 20 AND 24)

In case the needle does not enter the braid properly, loosen the knurled ring (D, Fig. 20, page 16) and slightly loosen the

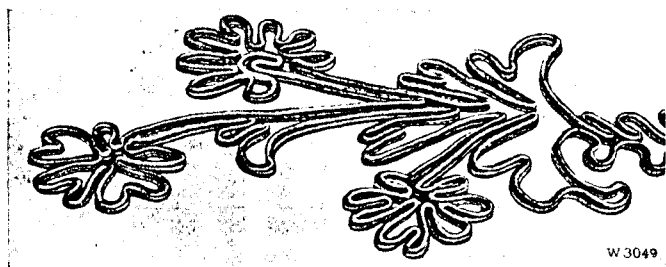

FIG. 24. BRAID SEWN "EDGE ON" FOR "STANDING" BRAID

small set screw (A, Fig. 20) in the braid guide to bring the guide closer to the needle. The braid guide should be set so that the needle just enters the edge of the braid at every stitch. When the braid guide has been properly adjusted, tighten the knurled ring (D).

**Tensions**

The needle and bobbin threads should be locked in the centre of the thickness of the material, thus:



FIG. 25. PERFECT STITCH

If the tension on the needle thread is too tight, or if that on the bobbin thread is too loose, the needle thread will lie straight along the upper surface of the material, thus:



FIG. 26. TIGHT NEEDLE THREAD TENSION

If the tension on the bobbin thread is too tight, or if that on the needle thread is too loose, the bobbin thread will lie straight along the under side of the material, thus:



FIG. 27. LOOSE NEEDLE THREAD TENSION

**To Regulate the Tensions**

(SEE FIG. 28)

The tension on the needle thread is regulated by the thumb nut (B, Fig. 28, page 22) above the tension discs at the top of the machine. To increase the tension turn this thumb nut over to the right or downward. To decrease the tension turn the thumb nut over to the left or upward.

The tension on the bobbin thread is regulated by the screw on the underside of the shuttle. To increase the tension turn this screw over to the right. To decrease the tension turn the screw over to the left.

### To Adjust the Thread Controller Spring

(SEE FIG. 28)

The stopping position of the thread controller spring (C, Fig. 28) should be so adjusted that when the machine is sewing, the spring will have a movement of about one inch.

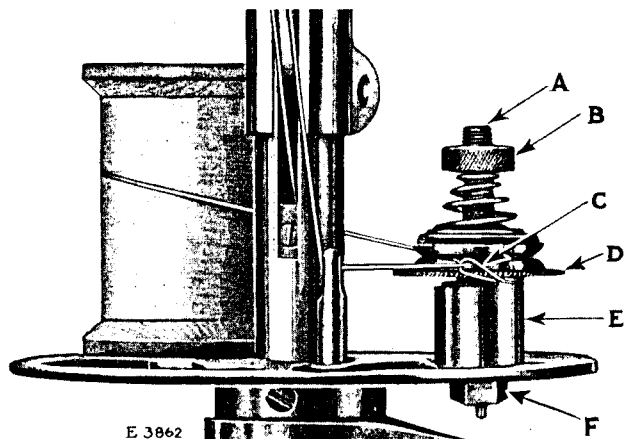

FIG. 28. ADJUSTMENTS ON THE THREAD CONTROLLER SPRING

To adjust the stopping position of the spring, loosen the hexagon nut (F, Fig. 28) on the underside of the spool platform and turn the barrel (E, Fig. 28) until the desired stopping position is reached, then securely tighten the hexagon nut (F).

The tension on the thread controller spring should be just tight enough to take up the slack thread. To increase the tension on the spring, loosen the tension stud (A, Fig. 28) and turn the knurled disc (D, Fig. 28) over to the right. To decrease the tension on the spring, turn the knurled disc over to the left. After the desired tension is obtained, tighten the tension stud (A).

### To Regulate the Length of Stitch

The length of stitch is regulated by means of the eccentric stitch adjusting collar (A, Fig. 29). To shorten the stitch, turn

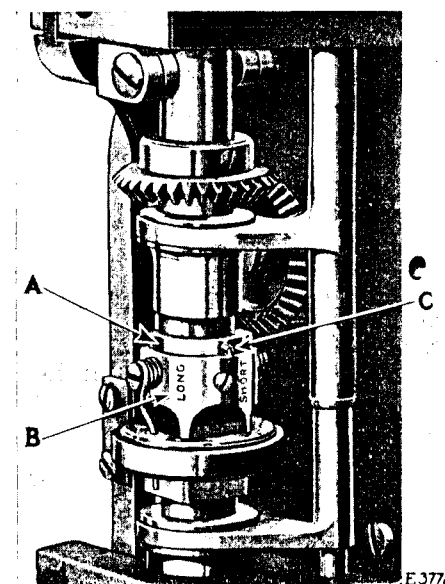

FIG. 29. STITCH REGULATOR

the handle (A, Fig. 5, page 5) to the right, then grasp the stud (C, Fig. 29) and turn the eccentric collar (A) toward you or around to the right in the direction of the word "short" stamped on the feed lever bracket (B, Fig. 29). To increase the length of stitch, turn the eccentric collar (A) away from you or around to the left in the direction of the word "long" stamped on the feed lever bracket. Never move the stud (C) beyond the words "short" or "long" stamped on the feed lever bracket.

### To Regulate the Pressure on the Presser Foot

(SEE FIG. 4)

The pressure on the presser foot is regulated by the thumb screw (A, Fig. 4, page 4) at the top of the machine and to the rear. To increase the pressure, turn the thumb screw over to the right or downward. To decrease the pressure, turn the thumb screw over to the left, or upward.

When the machine is being driven slowly, the pressure on the presser foot should be very light. If the machine is to be driven rapidly, the pressure on the presser foot should be increased.

### To Regulate the Pressure on the Braid Guide

(SEE FIG. 4)

The pressure on the braid guide is regulated by the thumb screw (C, Fig. 4, page 4) at the top of the machine and to the front. To increase the pressure turn the thumb screw over to the right or downward. To decrease the pressure, turn the thumb screw over to the left or upward.

When the machine is being driven slowly, the pressure on the braid guide should be very light. If the machine is to be driven rapidly, the pressure on the braid guide should be increased.

### To Adjust the Tension on the Braid Spool

(SEE FIG. 30)

The tension on the braid spool is regulated by the thumb screw (B, Fig. 30) the end of this screw bearing against the flat

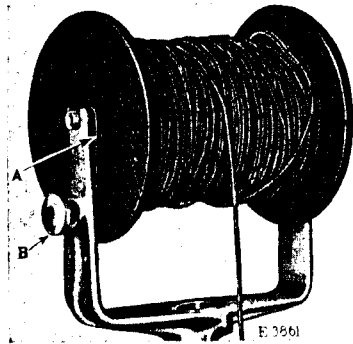

FIG. 30. BRAID SPOOL TENSION

tension spring (A, Fig. 30). To increase the tension, turn this thumb screw over to the right or inwardly. To decrease the tension, turn the thumb screw over to the left or outwardly.

The tension on the braid spool should be just tight enough to prevent the braid unwinding from the spool when the machine is stopped suddenly.