

KENWOOD

6.5-Inch WIDE TELEVISION

KVC-1000

INSTRUCTION MANUAL

KENWOOD CORPORATION

Before Use	
Safety Precautions	4
Monitor Control Function	
Opening the Monitor	5
Closing the Monitor	5
Power Off	5
Switching the Monitor's Picture	5
Switching the TV/Video Picture Mode	5
Switching the AV Output Picture	6
Switching to the Angle/Screen Control Screen	6
Turning the Monitor Picture Off	6
Switching to the Source Control Screen	6
Changing the Background of the Source Control Screen Picture	6
Adjusting the Volume	6
Angle Control Screen	
Adjusting the Angle Position	7
Adjusting the Slide Position	7
Turning the Automatic Open/Close Function On/Off	7
Switching to the Screen Control Screen	7
Ending the Angle Control Screen	7
Screen Control Screen	
Adjusting the Picture Quality	7
Turning the Dimmer Function On/Off	7
Switching to the Angle Control Screen	7
Ending the Screen Control Screen	7
System Setup Function	
Menu Screen	
Switching to the Menu Screen	8
Switching to the Setup Menu Screen	8
Switching to the Audio Control Screen	8
Switching to the Source Control Screen	8
Cancelling the Menu Screen	8
Setup Menu Screen	
Switching to the System Setting Screen	8
Switching to the TV Area Setting Screen	8
Switching to the RDS Setting Screen	8
Switching to the DAB Setting Screen	8
Switching to the Clock Adjustment Screen	8
Switching to the Touch Panel Adjustment Screen	8
Switching to the Code Security Screen	8
Cancelling the Setup Menu Screen	8
System Setting Screen -1	
Setting the AV Input	9
Setting the AV Output	9
Setting the Built-In Speaker Mode	9
Setting the Built-In Speaker Level	9
Switching to the Setting Screen -2	9
System Setting Screen -2	
Setting the Auto Scroll Display Function	9
Setting the Touch Sensor Tone	9
Setting the On Screen Display Function	9
Returning to the Setting Screen -1	9
Ending the System Setting Screen	9
TV Area Setting Screen	
Selecting the Preset Bands	10
Selecting the Television Area	10
Ending the TV Area Setting Screen	10
Clock Adjustment Screen	
Turning the Automatic Time Adjustment On/Off	10
Adjusting the Time Manually	10
Ending the Clock Adjustment Screen	10
Code Security Screen	
Mask Key	11
Ending the Code Security Screen	11
Touch Panel Adjustment Screen	
Adjusting the Touch Position	12
RDS Setting Screen	
News Bulletin Function with PTY News	
Timeout Setting	12
Alternative Frequency Function	13
Restricting RDS Region	13
Auto TP Seek Function	13
Ending the RDS Setting Screen	13
Audio Control Function	
Audio Control Screen -1	
Adjusting the Balance and Fader Levels	14
Adjusting the Bass Level	14
Adjusting the Treble Level	14
Switching to the Audio Control Screen -2	14
Audio Control Screen -2	
Turning the Loudness On/Off	14
Setting the Preout	14
Setting the High-Pass Filter for Front and Rear Output	14
Adjusting the Non-Fading Preout Level	14
Returning to the Audio Control Screen -1	14
Ending the Audio Control Screen	14
TV Control Function	
TV Control Screen (Main)	
Selecting the Bands	15
Selecting the Video Inputs	15
Selecting the Channels	15
Station Preset Memory	15
Recalling a Preset Station	15
Switching to the TV Control Screen (Shift)	15
Switching to the Next Source Mode	15
Switching to the Previous Source Mode	15
Switching to the Menu Screen	15
TV Control Screen (Shift)	
Auto Memory Entry	16
Selecting the Tuning Mode	16
Switching to the TV List Screen	16
Switching to the Name Set Screen	16
Returning to the TV Control Screen (Main)	16
TV List Screen	
Selecting the Band List	16
Selecting the Station	16
Returning to the Source Control Screen	16
Selecting the Channels on the TV Picture Screen	17
FM/AM Tuner Control Function	
Tuner Control Screen (Main)	
Selecting the Bands	18
Tuning	18
Station Preset Memory	18
Recalling a Preset Station	18
Switching to the PTY Search Screen	18
Switching to the Tuner Control Screen (Shift)	18
Switching to the Next Source Mode	18
Switching to the Previous Source Mode	18
Switching to the Menu Screen	18
Tuner Control Screen (Shift)	
Auto Memory Entry	19
Turning the Monaural Reception On/Off	19
Selecting the Tuning Mode	19
Turning the Local Seek Function On/Off	19
Traffic Information Function	20
Presetting the Volume for Traffic Information/News	20
Returning the Tuner Control Screen (Main)	20
PTY Search Screen	
Changing the Display Language to French or German	21
Selecting the Type of Programme to be Received	21
Seeking the Selected Programme Type	21

Cancelling the PTY Search Screen	21	Disc Repeat Function	24
DAB Tuner Control Function		Track Scan Function	24
DAB Setup Screen		Disc Scan Function	24
Automatic Switching from DAB to RDS	22	Track Random Play Function	25
Dynamic Range Control	22	Magazine Random Play Function	25
Restricting the DAB Region	22	Switching to the Disc Changer Control Screen (Shift)	25
DAB Control Screen (Main)		Switching to the Next Source Mode	25
Switching the Ensemble	22	Switching to the Previous Source Mode	25
Selecting the Type of Programme to be Received	22	Switching to the Menu Screen	25
Service Preset Memory	22	Disc Changer Control Screen (Shift)	
Turning the DAB PTY Search On/Off	22	Selecting the Name or Title Display for Discs	26
Switching the DAB Control Screen (Shift)	22	To Scroll Manually	26
Switching to the Next Source Mode	22	Selecting the Time Display for CDs	26
Switching to the Previous Source Mode	22	Switching to the Disc List Screen	26
Switching to the Menu Screen	22	Switching to the Name Set Screen	26
DAB Control Screen (Shift)		Returning to the Disc Changer Control Screen (Main)	26
Selecting the Seek Mode	23	Disc List Screen	
Auto Memory Entry	23	Changing to the Disc List	26
Dual Channel Audio Switching	23	Selecting the Disc	26
Primary/Secondary Switching	23	Switching the Display for Discs	26
Presetting the Volume Level for Traffic Information/News	23	Returning to the Source Control Screen	26
Returning to the DAB Control Screen (Main)	23	Name Set Function	
Disc Changer Control Function		Name Set Screen	
Disc Changer Control Screen (Main)		Station Name Preset (SNPS)/Disc Name Preset (DNPS)	27
Pausing and Restarting CD Play	24	Remote Control Function	28
Track Search	24	Installation	30
Fast Forwarding and Reversing Disc Play	24	Troubleshooting Guide	34
Disc Search	24	Specifications	36
Track Repeat Function	24		

**The control screens shown in this manual are for explanation purposes only.
The actual screens and design differ.**

The TV must be set according to the TV Area Setting Screen (see page 10).

Safety Precautions

▲ WARNING

To prevent injury and/or fire, take the following precautions:

- Ensure that the unit is securely installed. Otherwise it may fly out of place during collisions and other jolts.
- When extending the ignition, battery or ground cables, make sure to use automotive-grade cables or other cables with an area of 0.75mm² (AWG18) or more to prevent cable deterioration and damage to the cable coating.
- To prevent short circuits, never put or leave any metallic objects (e.g., coins or metal tools) inside the unit.
- If the unit starts to emit smoke or strange smells, turn off the power immediately and consult your Kenwood dealer.
- Do not touch the liquid crystal fluid if the LCD is damaged or broken due to shock. The liquid crystal fluid may be dangerous to your health or even fatal. If the liquid crystal fluid from the LCD contacts your body or clothing, wash it off with soap immediately.

▲ CAUTION

To prevent damage to the machine, take the following precautions:

- Make sure to ground the unit to a negative 12V DC power supply.
- Do not open the top or bottom covers of the unit.
- Do not install the unit in a spot exposed to direct sunlight or excessive heat or humidity. Also avoid places with too much dust or the possibility of water splashing.
- Do not subject the faceplate to excessive shock, as it is a piece of precision equipment.
- When replacing a fuse, only use a new one with the prescribed rating. Using a fuse with the wrong rating may cause your unit to malfunction.
- To prevent short circuits when replacing a fuse, first disconnect the wiring harness.
- Do not use any screws except for the ones provided. The use of improper screws might result in damage to the main unit.
- You cannot view video pictures whilst the vehicle is moving. To enjoy TV/video pictures, find a safe place to park and engage the parking brake.

NOTE

- If you experience problems during installation, consult your Kenwood dealer.
- If the unit does not seem to be working right, try pressing the reset button first. If that does not solve the problem, consult your Kenwood dealer.

Reset button

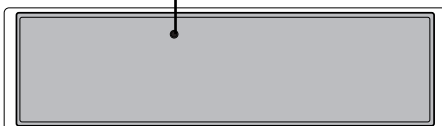

Mask key

If you have transmitted the Mask Key's signal once to the unit in advance, you will have to transmit it once again if the unit has been removed from the battery.

If this procedure is not carried out, the control panel of the unit will re-open even with your vehicle's ignition turned off.

▲ CAUTION

Do not lose the "Mask Key".

If power is disconnected from the unit, correct operation can only be restored by the "Mask Key's" signal. The "Mask Key" will also be required for service repair.

NOTE

If you send products in for repair that include a mask key, make sure to present the unit together with the mask key.

Cleaning the Unit

If the front panel gets dirty, turn off the power and wipe the panel with a dry silicon cloth or soft cloth.

▲ CAUTION

Do not wipe the panel with a stiff cloth or a cloth dampened by volatile solvents such as paint thinner and alcohol. They can scratch the surface of the panel and/or remove the indicator letters.

Screen brightness during low temperatures

When the temperature of the unit falls such as during winter, the liquid crystal panel's screen will become darker than usual. Normal brightness will return after using the monitor for a whilst.

Loading and Replacing the Batteries for the Remote

▲ CAUTION

Do not set the remote on hot places such as above the dashboard.

Loading and Replacing the Batteries

1. Use two "AAA" batteries.
Slide the cover while pressing downwards to remove it as illustrated.
2. Insert the batteries with the ⊕ and ⊖ poles aligned properly following the illustration inside the case.

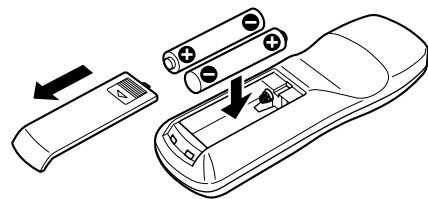

▲ WARNING

Store unused batteries out of the reach of children. Contact a doctor immediately if the battery is accidentally swallowed.

NOTE

- The provided batteries are intended for use in operation checking, and their service life may be short.
- When the remote controllable distance becomes short, replace both of the batteries with new ones.

Monitor Control Function

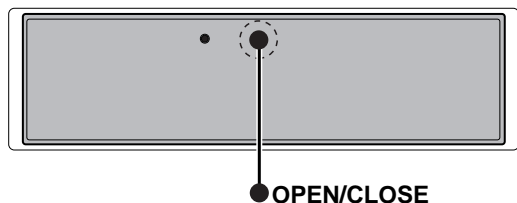

► Opening the Monitor

- 1 Set the vehicle's parking brake.
- 2 Press the OPEN/CLOSE button. The monitor will open.

▲ CAUTION

The gear shift lever or other parts may interfere with the monitor when it opens. If so, move the gear shift lever (being sure to do so safely) before operating the set. (The monitor is drawn back in automatically if it cannot be opened normally due to an obstacle.)

NOTE

The monitor cannot be opened unless the parking brake is set.

► Closing the Monitor

Press the OPEN/CLOSE button. The monitor will close.

NOTE

- The monitor cannot be closed unless the parking brake is set.
- The position to which the monitor slides or angle when the power is turned on can be set. (Refer to the angle control screen on (Page 7).)

► Power Off

Hold down the OPEN/CLOSE button for one second or more to turn the set's power off. Press the OPEN/CLOSE button to turn the power on.

► Switching the Monitor's Picture

Each time you press the V.SEL button, the monitor's picture switches as follows:

AV IN setting during "VD" (Page 9)

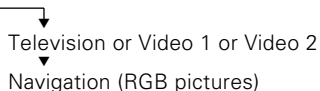

AV IN setting during "NAV" (Page 9)

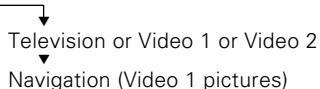

NOTE

The video 1 will not select when the "IN-OUT" switch is set to "OUT" (Page 32).

▲ CAUTION

You cannot view television and video pictures whilst the vehicle is moving. To enjoy television and video pictures, find a safe place to park and engage the parking brake.

► Switching the TV/Video Picture Mode

Each time you press the MODE button, the picture mode switches between full, zoom, just, cinema and normal.

NOTE

You cannot operate when the wide navigation system is connected.

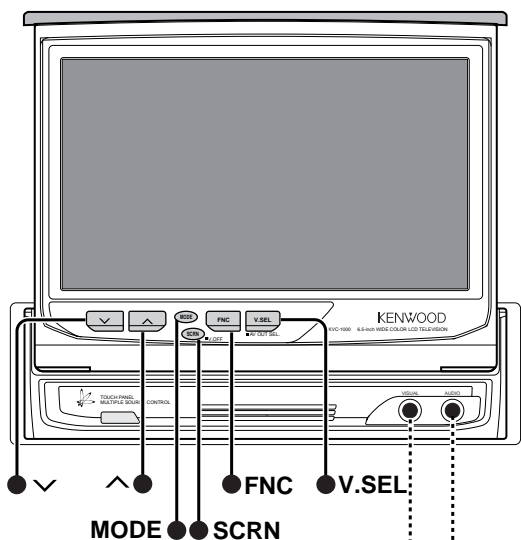

Video input terminal (AV-IN 2) (3.5σ-Monaural)

Audio input terminal (AV-IN 2) (3.5σ-Stereo)

• Normal mode

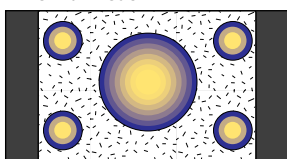

• Full mode

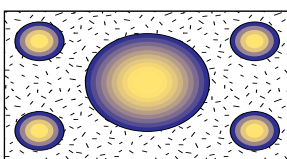

• Just mode

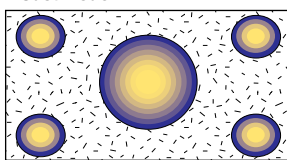

• Zoom mode

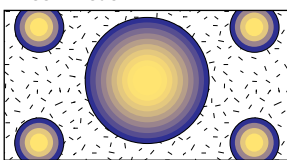

• Cinema mode

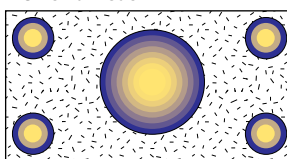

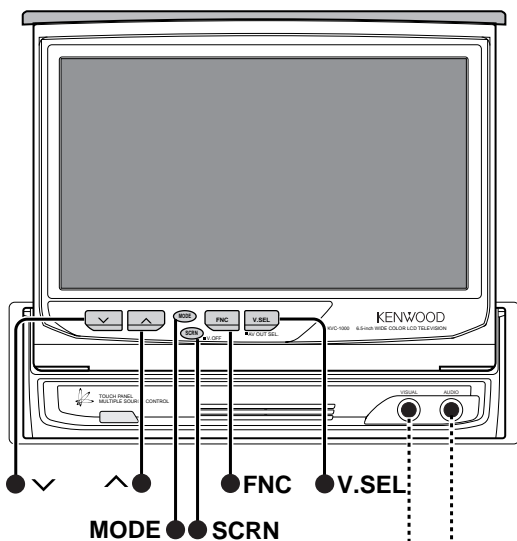

Video input terminal (AV-IN 2) (3.5φ-Monaural)

Audio input terminal (AV-IN 2) (3.5φ-Stereo)

► Switching the AV Output Picture

Each time you press the V.SEL button for one second or more, AV output picture switches as follows:

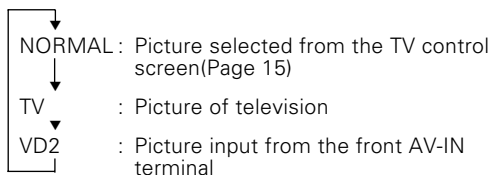

NOTE

The unit will not operate when the "IN-OUT" switch is set to "IN" (Page 32).

► Switching to the Angle/Screen Control Screen

Pressing the SCRN button will cause the angle control screen (monitor angle adjustment mode) or screen control screen (screen adjustment mode) to be displayed on the TV or video picture (Page 7).

► Turning the Monitor Picture Off

Hold down the SCRN button for two seconds or more to turn the monitor's picture off.

NOTE

The picture reappears when the one of the SCRN, FNC, MODE or V.SEL buttons is pressed.

► Switching to the Source Control Screen

Press the FNC button to switch to the source control screen (Page 15-27).

► Changing the Background of the Source Control Screen Picture

Each time you press the FNC button, you can select the background between 5 different patterns for the source control screen and menu screen.

► Adjusting the Volume

When the KTC-1000R/A907 is not connected to the system

Press the ▲ button to increase the volume of the built-in speaker.

Press the ▼ button to decrease the volume of the built-in speaker.

When the KTC-1000R/A907 is connected

Press the ▲ button to increase the volume of the KTC-1000R/A907.

Press the ▼ button to decrease the volume of the KTC-1000R/A907.

Angle Control Screen

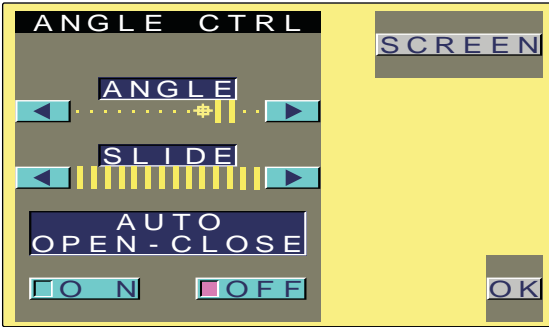

▶ Adjusting the Angle Position [ANGLE]

Each time you touch [►], the monitor slants back one step.
Each time you touch [◀], the monitor slants forward one step

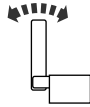

NOTE

The angle can be adjusted in 9 steps.

▶ Adjusting the Slide Position [SLIDE]

Touch [►] to slide the monitor one step to the front.
Touch [◀] to slide the monitor one step to the back.

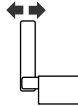

NOTE

This slide position can be adjusted in 3 steps.

▶ Turning the Automatic Open/Close Function On/Off [AUTO OPEN-CLOSE]

Touch [ON] or [OFF] to switch the function on and off.

- ON** : Switch the ACC ON/OFF to open/close the monitor
- OFF** : Use the OPEN/CLOSE button to open/close the monitor

NOTE

If the shift lever or other parts of the vehicle interfere with the monitor when it opens, select [OFF].

▶ Switching to the Screen Control Screen

Touch [SCREEN] to switch to the screen control screen.

▶ Ending the Angle Control Screen

Touch [OK].

Screen Control Screen

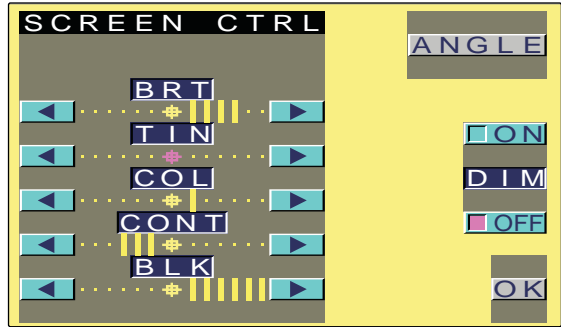

▶ Adjusting the Picture Quality

[BRT]

Touch [►] for a brighter screen.
Touch [◀] for a darker screen.

[TIN]

Touch [►] for a stronger green level.
Touch [◀] for a stronger red level.

[COL]

Touch [►] for a deeper colour.
Touch [◀] for a paler colour.

[CONT]

Touch [►] for less contrast.
Touch [◀] for stronger contrast.

[BLK]

Touch [►] for less blackness.
Touch [◀] for a stronger black level.

NOTE

- The [TIN] and [COL] cannot be adjusted for the navigation screen or the graphic screens (Audio source control, etc.).
- The [TIN] cannot be adjusted for the picture of PAL/SECAM.
- Separate picture quality settings can be stored for the television, video 1, video 2, graphic screens and navigation screens and for day and night use.

▶ Turning the Dimmer Function On/Off

Touch [ON] or [OFF] to switch the function on and off.

- ON** : Switch head light ON, and switch to nighttime viewing screen picture
- OFF** : Leave the set in nighttime viewing screen picture

NOTE

When adjusting nighttime picture quality, switch this function ON and switch head lights ON.

▶ Switching to the Angle Control Screen

Touch [ANGLE] to switch to the angle control screen.

▶ Ending the Screen Control Screen

Touch [OK].

Menu Screen

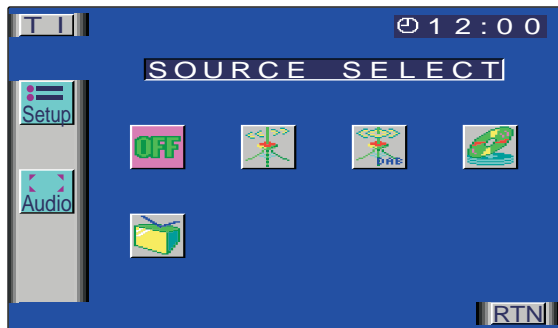

► Switching to the Menu Screen

- 1 Press the FNC button on the monitor. The source control screen is displayed (Page 15-27).
- 2 Touch [MENU] to switch to the menu screen.

► Switching to the Setup Menu Screen

Touch [Setup] to switch to the setup menu screen.

► Switching to the Audio Control Screen

<With the KTC-1000R/A907>

Touch [Audio] to switch to the audio control screen (Page 14).

► Switching to the Source Control Screen

Touch the marks to switch to the source control screen as follows:



Touch this mark to switch to the Tuner control screen (Page 18). <With the KTC-1000R/A907>



Touch this mark to switch to the DAB control screen (Page 22). <With the KTC-959DAB>



Touch this mark to switch to the disc changer control screen (Page 24). <With the disc changer >



Touch this mark to switch to the TV control screen (Page 15).



Touch this mark to switch to the standby mode screen.

The mark for the currently selected source is displayed in light pink.

NOTE

Up to two disc changers can be operated.

► Cancelling the Menu Screen

Touch [RTN] to switch to the source control screen for the current source.

Setup Menu Screen

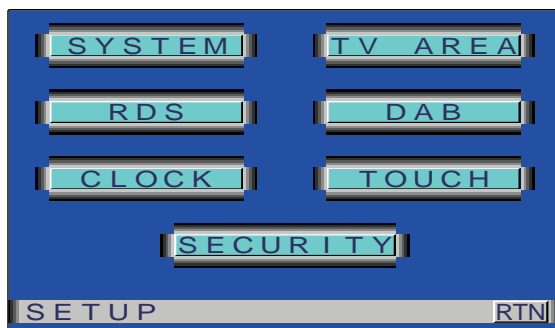

► Switching to the System Setting Screen

Touch [SYSTEM] to switch to the system setting screen (Page 9).

► Switching to the TV Area Setting Screen

Touch [TV AREA] to switch to the TV area setting screen (Page 10).

► Switching to the RDS Setting Screen

Touch [RDS] to switch to the RDS setting screen (Page 12).

► Switching to the DAB Setting Screen

Touch [DAB] to switch to the DAB setting screen (Page 22).

► Switching to the Clock Adjustment Screen

Touch [CLOCK] to switch to the clock adjustment screen (Page 10).

► Switching to the Touch Panel Adjustment Screen

Touch [TOUCH] to switch to the panel adjustment screen (Page 12).

► Switching to the Code Security Screen

Keep touching [SECURITY] for two seconds or more to switch to the code security screen (Page 11).

► Cancelling the Setup Menu Screen

Touch [RTN] to switch to the menu screen.

System Setting Screen - 1

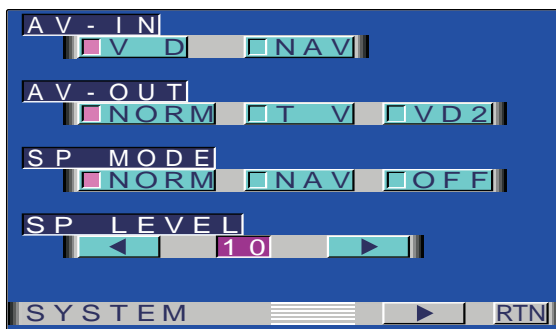

▶ Setting the AV Input [AV-IN]

Touch [VD] or [NAV] to switch the AV IN 1 terminal's input setting between Video and Navigation mode.

- **V D** : Set the video mode
- **N A V** : Set the navigation mode

NOTE

- There is no display when the unit's "IN-OUT" switch is set to "OUT" (Page 32).
- If a navigation unit is connected to AV IN, be sure to set it to [NAV].

▶ Setting the AV Output [AV-OUT]

Touch [NORM], [TV] or [VD2]. The video of the AV output terminal will be switched as follows:

- **N O R M** : Picture selected from the TV control screen (Page 15)
- **T V** : Picture of the television
- **V D 2** : Picture input from the front AV-IN terminal

NOTE

There is no display when the unit's "IN-OUT" switch is set to "IN" (Page 32).

▶ Setting the Built-In Speaker Mode [SP MODE]

- **N O R M** : Sound with monitor picture
- **N A V** : Sound with navigation
- **O F F** : Switch off the built-in speakers

▶ Setting the Built-In Speaker Level [SP LEVEL]

Touch [▶] to increase the volume.
Touch [◀] to decrease the volume.

NOTE

No display when the "SP MODE" is set to "OFF".

▶ Switching to the Setting Screen -2

Touch [▶] to switch to the setting screen-2.

System Setting Screen - 2

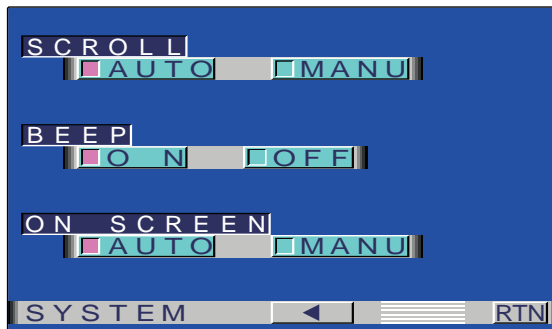

▶ Setting the Auto Scroll Display Function [SCROLL]

This function permits the text to be scrolled and the entire text to be displayed. Switching between manual scrolling and automatic scrolling is permitted.

Touch [AUTO] or [MANU] to switch the function automatic and manual scrolling.

- **A U T O** : Automatic scrolling
- **M A N U** : Manual scrolling

▶ Setting the Touch Sensor Tone [BEEP]

Touch [ON] or [OFF] to switch the function on and off.

- **O N** : Touch sensor tone is turned on
- **O F F** : Touch sensor tone is turned off

▶ Setting the On Screen Display Function [ON SCREEN]

Touch [AUTO] or [MANU] to switch the function between automatic and manual.

- **A U T O** : When a button on the main unit or remote control unit is pressed, or the disc track is changed, the audio source control information is temporarily superimposed on the picture
- **M A N U** : When the lower centre of the screen is touched whilst a TV/video picture is displayed, the audio source control information is temporarily superimposed on the picture

▶ Returning to the Setting Screen -1

Touch [◀] to return to the setting screen-1.

▶ Ending the System Setting Screen

Touch [RTN] to return to the setup menu screen.

TV Area Setting Screen



▶ Selecting the Preset Bands

Touch [TV 1] or [TV 2]. The band switches between the TV1 and TV2.

▶ Selecting the Television Area

Select the area for video broadcast viewing.

Touch [1] - [6] to select the channel setting for your country as follows.

■ 1 (A1)	Germany Iceland Portugal Netherlands Belgium Switzerland Austria Sweden Norway Denmark Finland Yugoslavia Spain	PAL-B/G
■ 2 (A2)	Italy Albania	
■ 3 (A3)	United Kingdom Ireland	PAL-I
■ 4 (A4)	France	SECAM-L
■ 5 (A5)	Russia Poland Hungary Czech Slovakia Bulgaria Roumania	SECAM-D/K
■ 6 (A6)	Greece	SECAM-B/G

▶ Ending the TV Area Setting Screen

Touch [RTN] to return to the setup menu screen.

Clock Adjustment Screen

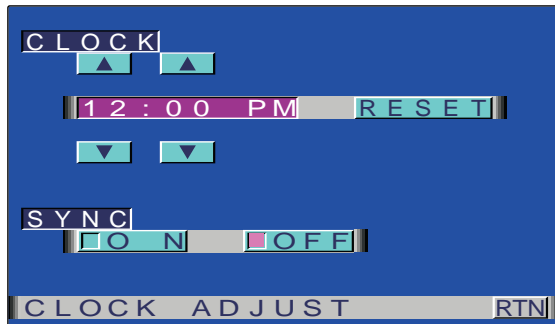

▶ Turning the Automatic Time Adjustment On/Off [SYNC]

With automatic time adjustment, you can set the clock time automatically according to time data sent from RDS stations (after receiving RDS signals for several minutes). You can also set the time manually if the automatic time adjustment function is turned off. The factory default is automatic time adjustment.

Touch [ON] or [OFF] to switch the function on and off.

■ **ON** : Tune into an RDS station for 3 or 4 minutes
The time adjusts automatically to the correct local time

■ **OFF** : Manual adjusting

NOTE

The time is not adjusted when the RDS station you are tuned to be not transmitting a time signal. Choose another RDS station in such a case.

▶ Adjusting the Time Manually [CLOCK]

Touch [▲] to advance the hours.

Touch [▲] to advance the minutes.

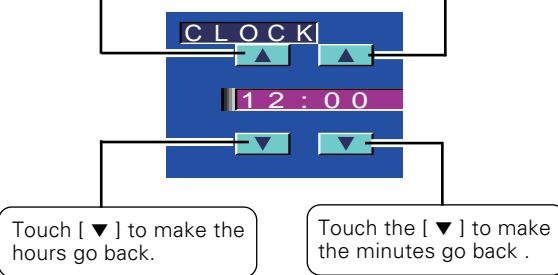

Setting the Minutes to "00":

Touch [RESET] to set the minutes to "00".

NOTE

- Touch [RESET] whilst the minute is below "30" rounds it off, and whilst the minute is "30" or more rounds it up.
- No display when the "SYNC" is set to "ON".

▶ Ending the Clock Adjustment Screen

Touch [RTN] to return to the setup menu screen.

Code Security Screen

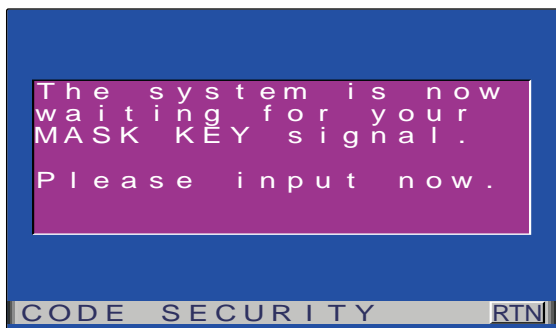

► Mask Key

If you have transmitted the Mask Key's signal once to the unit in advance, you will have to transmit it once again if the unit has been removed from the battery. This function helps prevent theft.

When using the unit for the first time:

If this procedure is not carried out, the control panel of the unit will re-open even with your vehicle's ignition turned off.

- 1 Hold down the transmit button on the Mask Key until the half transmit level indicator lights up in the display. "System now checking for valid signal code" will be displayed.

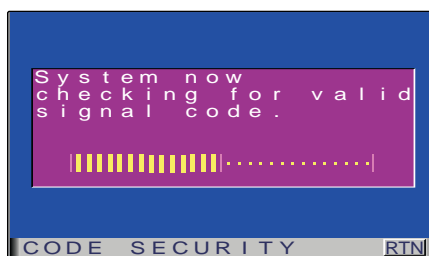
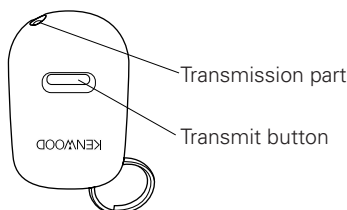

NOTE

- Keep the Mask Key close to the signal sensor when you transmit the Mask Key signal.
- If the Mask Key signal does not be received correctly, the display will return to "Code rejected. Please check MASK KEY". In this case, repeat the procedure in step 1.

- 2 Hold down the transmit button on the Mask Key again until the full transmit level indicator lights up in the display.

"Code APPROVED" will appear in the display, with the Mask Key function turning on.

If you press the RESET button or remove the battery:

The first time you turn the unit on again, "The system is now waiting for your MASK KEY signal. Please input now." will appear in the display, indicating the setting mode has been entered. Repeat steps 1 and 2 above, and transmit the signal. You can start operating the unit again when "Code APPROVED" appears in the display.

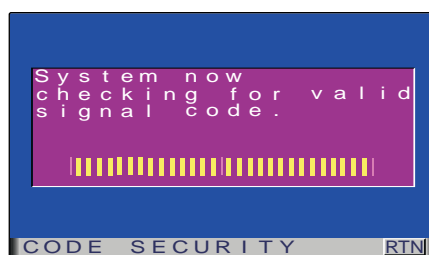

► Ending the Code Security Screen

Touch [RTN] to return to the setup menu screen.

Touch Panel Adjustment Screen

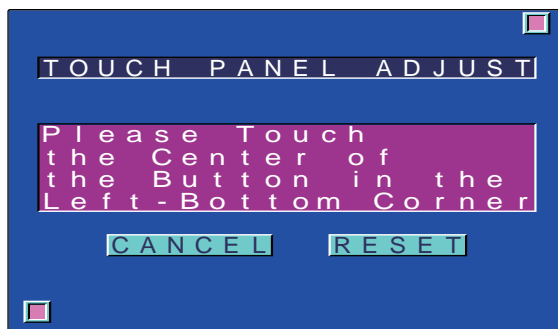

► Adjusting the Touch Position

The touch panel can be adjusted if the position touched and the operation performed do not match.

Accurately touch the mark at the lower left and the mark at the upper right, following the instructions in the messages.

When the mark at the upper right is touched, the adjustment is completed and the system setup menu screen reappears.

NOTE

- If [CANCEL] is touched without touching the button at the lower left, the adjustment is cancelled and the screen that was set before switching to the system setup menu reappears.
- If [CANCEL] is touched after touching the button at the lower left, the button at the lower left reappears.
- If [RESET] is touched, the settings are reset to the factory defaults and the setup menu screen reappears.

RDS Setting Screen

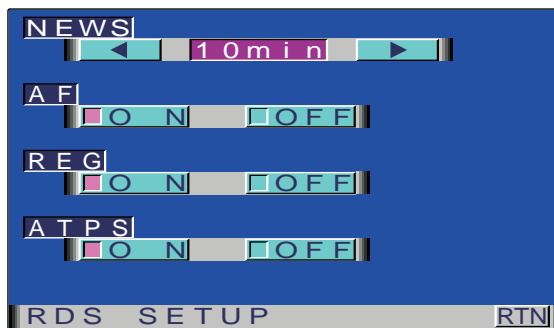

RDS (Radio Data System)

RDS is a digital information system that lets you receive signals besides those of regular radio programmes, such as network information being transmitted from radio stations.

When listening to an RDS station (ie, a station with RDS capability), the programme service name of the station is displayed along with the frequency, advising you quickly which station is being received.

RDS (Radio Data System) stations also transmit frequency data for the same station. When you are making long trips, this function automatically switches to the particular frequency with the best reception for the particular network of stations that you want to listen to. The data is automatically stored, allowing you to switch quickly to another RDS stations, broadcasting the same programme, that has better reception. These include stations stored in the station preset memory that you often listen to.

EON (Enhanced Other Network)

Stations that offer EON also transmit information about other RDS stations that have traffic information. When you are tuned to a station that is not transmitting traffic information, but another RDS station starts transmitting a traffic bulletin, the tuner automatically switches to the other station for the duration of the bulletin.

Alarm

When an emergency transmission (announcing disasters, etc.) is sent, all current functions are interrupted to allow the warning to be received.

► News Bulletin Function with PTY News Timeout Setting [NEWS]

You can arrange to have news bulletins interrupt your current listening source, including other radio stations. When the News Bulletin function is on, the PTY News Timeout setting allows you to set the interval during which further news interruption cannot take place. You can adjust the PTY news interruption period from 10 to 90 minutes for each journey.

Changing the Function Setting:

Touch [◀] or [▶] repeatedly until the desired setting is displayed.

Touch [▶] to increase the interval, and the [◀] to decrease it.

OFF ↔ 00min ↔ 10min ↔ 20min ↔ 30min ↔ 40min ↔ 50min ↔ 60min ↔ 70min ↔ 80min ↔ 90min
(min= minutes)

When you select the news interruption timeout interval, the News function turns on and the NEWS indicator is displayed.

When a news bulletin is received, the NEWS indicator will blink and reception will begin at the preset volume.

NOTE

- If you choose the "20min" setting, further news bulletins will not be received for 20 minutes once the first news bulletin is received. Setting the interval at the "OFF" factory default indicates no News Timeout will be made, meaning that additional news bulletins will continue to be searched for.
- This function is only available if the desired station sends PTY-code for news bulletin or belongs to EON-Network sending PTY-code for news bulletin.

► **Alternative Frequency Function [AF]**

When poor reception is experienced, automatically switch to another frequency broadcasting the same programme in the same RDS network with better reception.

The AF indicator is displayed when the AF function is turned on.

Turning AF Function On/Off:

Touch [ON] or [OFF] to switch the function on and off.

- O N** : AF function is turned on
 O F F : AF function is turned off

NOTE

When no other stations with stronger reception are available for the same programme in the RDS network, you may hear the incoming broadcast in bits and snatches. Turn off the AF function in such a case.

► **Restricting RDS Region (Region Restrict Function) [REG]**

You can choose whether or not to restrict the RDS channels, received with the AF function for a particular network, to a specific region. When the Region Restrict Function is on, the region is restricted and the REG indicator is displayed.

Turning Region Restrict Function On/Off:

Touch [ON] or [OFF] to switch the function on and off.

- O N** : Region restrict function is turned on
 O F F : Region restrict function is turned off

NOTE

Sometimes stations in the same network broadcast different programmes or use different programme service names.

► **Auto TP Seek Function [ATPS]**

When the TI function is on and poor reception conditions are experienced when listening to a traffic information station, another traffic information station with better reception will be searched for automatically. This function is on, when unit is first powered on.

Turning Auto TP Seek Function On/Off:

Touch [ON] or [OFF] to switch the function on and off.

- O N** : Auto TP seek function is turned on
 O F F : Auto TP seek function is turned off

► **Ending the RDS Setting Screen**

Touch [RTN] to return to the setup menu screen.

Audio Control Screen - 1



▶ Adjusting the Balance and Fader Levels [BAL/FAD]

Each time you touch [◀](L), the sound in the left channel is emphasized.
 Each time you touch [▶](R), the sound in the right channel is emphasized.
 Each time you touch [▲](F), the sound in the front channel is emphasized.
 Each time you touch [▼](R), the sound in the rear channel is emphasized.

▶ Adjusting the Bass Level [BASS]

Each time you touch [▶], the bass level is increased.
 Each time you touch [◀], the bass level is decreased.

▶ Adjusting the Treble Level [TREBLE]

Each time you touch [▶], the treble level is increased.
 Each time you touch [◀], the treble level is decreased.

▶ Switching to the Audio Control Screen -2

Touch [▶] to switch to the audio control screen-2.

Audio Control Screen - 2



▶ Turning the Loudness On/Off [LOUD]

This function amplifies low and high tones when the volume is turned down.
The LOUD indicator is displayed on the source control screen, when the loudness function is on.

Touch [ON] or [OFF] to switch the function on and off.

ON : Loudness function is turned on

OFF : Loudness function is turned off

▶ Setting the Preout [PREOUT]

Touch [REAR] or [NF] to switch the non-fading preout and rear preout.

REAR : Set the rear preout

NF : Set the non-fading preout

▶ Setting the High-Pass Filter for Front and Rear Output [HP-F] [HP-R]

Each time you touch [◀] or [▶], you can select the frequency to be cut, as follows:

OFF ⇄ 40Hz ⇄ 60Hz ⇄ 80Hz ⇄ 100Hz ⇄ 220Hz ⇄ 180Hz ⇄ 150Hz ⇄ 120Hz

▶ Adjusting the Non-Fading Preout Level [NF-LV]

Each time you touch [▶], the non-fading sound increased.

Each time you touch [◀], the non-fading sound decreased.

▶ Returning to the Audio Control Screen -1

Touch [◀] to return to the audio control screen-1.

▶ Ending the Audio Control Screen

Touch [RTN] to return to the menu screen.

TV Control Screen (Main)



▶ Switching to the TV Control Screen (Shift)

Touch [◀] to switch the TV control screen (Shift).

▶ Switching to the Next Source Mode

Touch the mark located at the lower side of ▼ to switch to the next source control screen.

▶ Switching to the Previous Source Mode

Touch the mark located at the upper side of ▲ to switch to the previous source control screen.

▶ Switching to the Menu Screen

Touch [MENU] to switch to the menu screen.

▶ Selecting the Bands

Touch [TV] to select the band.
Each time you touch [TV], the band switches between the TV1 and TV2.

▶ Selecting the Video Inputs

Each time you touch [VD], the video input switches between the video 1 and video 2.

NOTE

The video 1 will not select when the "IN-OUT" switch is set to "OUT" (Page 32).

▶ Selecting the Channels

Auto Seek Tuning (AUTO1)

Touch [▶▶] to seek for channels up the band.
Touch [◀◀] to seek for channels down the band.

Preset station Seek Tuning (AUTO2)

Touch [▶▶] to move to the next preset station (i.e., the one with the next highest number).
Touch [◀◀] to move to the last preset station (i.e., the one with the next lowest number).

Manual Tuning (MANU)

Touch [▶▶] to increase the channel by one step.
Touch [◀◀] to decrease the channel by one step.

▶ Station Preset Memory

Store the channel of the station currently being listened to. You can then recall that station with a single touch of a button.

- 1 Select the band/ station that you want to store.
- 2 Hold down preset station number [P1] - [P6] on which you want to store the station, for two seconds or more.

NOTE

You can store 6 stations in each of the TV1 and TV2 bands.

▶ Recalling a Preset Station

Touch the preset station number [P1] - [P6] for the desired station. The number of the recalled station is displayed.

TV Control Function

TV Control Screen (Shift)



▶ Auto Memory Entry

You can automatically store all the receivable channels in the band currently being listened to, and then recall them with the touch of a button later. This function is especially useful when you are travelling and do not know what stations are available. Up to 6 stations can be stored this way.

- 1 Select the band for auto memory entry.
- 2 Touch [AME].
[►►] and [◀◀] blink.
- 3 Touch [►►] or [◀◀] to start auto memory entry.
The preset station numbers [P1] - [P6] are shown in order.

When all the stations on a certain band have been stored in the preset memory, the auto memory entry stops. The tuner then plays the last station received.

▶ Selecting the Tuning Mode

You can choose from three tuning modes: auto seek, preset station seek, and manual. The "AUTO1" indicator is displayed when auto seek tuning is selected, and the "AUTO2" indicator is displayed when preset station seek tuning is selected.

Each time you touch [SEEK], the mode switches as follows:

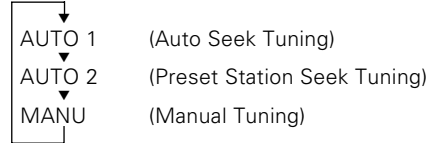

▶ Switching to the TV List Screen

Touch [LIST] to switch to the TV list screen.

▶ Switching to the Name Set Screen

Touch [NAME] to switch to the name set screen (Page 27).

NOTE

You cannot operate unless the parking brake is set.

▶ Returning to the TV Control Screen (Main)

Touch [◀] to return to the TV control screen (Main).

TV List Screen

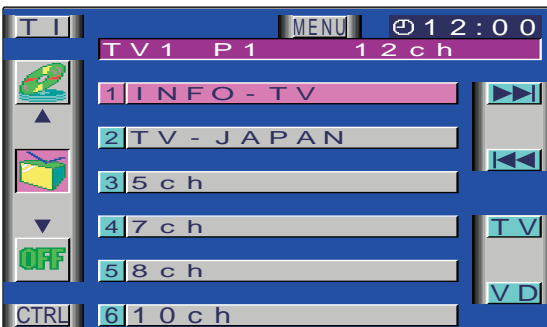

▶ Selecting the Band List

Each time you touch [TV], the list switches between the TV1 and TV2.

▶ Selecting the Station

Touch station number or name in the list for the desired station. The number of the recalled station is displayed.

▶ Returning to the Source Control Screen

Touch [CTRL] to return to the source control screen (Shift).

Selecting the Channels on the TV Picture Screen

Touch the upper centre to switch between the TV1 and TV2 bands

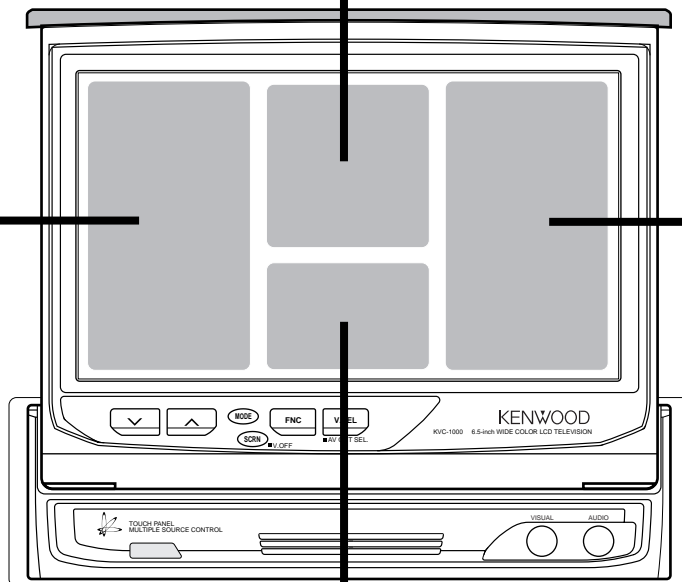

Touch the left part to decrease the channel

Touch the right part to increase the channel

The lower centre of the screen is touched whilst a TV/video picture is displayed, the audio source, picture settings, video out settings, etc., are superimposed on the picture (On Screen Display). The display turns off when the lower centre of the screen is pressed again.

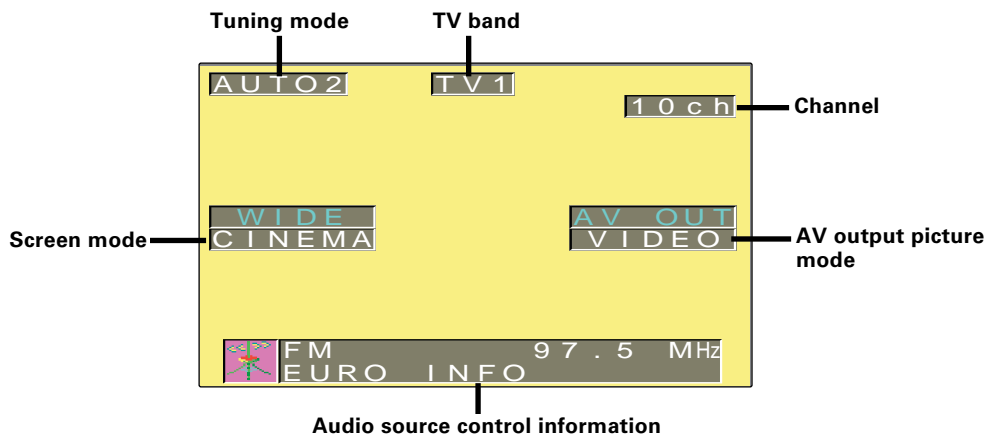

FM/AM Tuner Control Function

Tuner Control Screen (Main)



► Switching to the Next Source Mode

Touch the mark located at the lower side of ▼ to switch to the next source control screen.

► Switching to the Previous Source Mode

Touch the mark located at the upper side of ▲ to switch to the previous source control screen.

► Switching to the Menu Screen

Touch [MENU] to switch to the menu screen.

► Selecting the Bands

Touch either [FM] or [AM] to select the band. Each time you touch [FM], the band switches between the FM1, FM2 and FM3. Touch [AM] to select the MW and LW bands.

► Tuning

Auto Seek Tuning (AUTO1)

Touch [►►] to seek increasing frequencies. Touch [◄◄] to seek decreasing frequencies.

Preset Station Seek Tuning (AUTO2)

Touch [►►] to move to the next preset station (i.e., the one with the next highest number), and [◄◄] to move to the last preset station (i.e., the one with the next lowest number).

Manual Tuning (MANU)

Touch [►►] to increase the frequency by one step. Touch [◄◄] to decrease the frequency by one step.

NOTE

The ST indicator is displayed when stereo broadcasts are being received.

► Station Preset Memory

Store the frequency of the station currently being listened to. You can then recall that station with a single touch of a button.

- 1 Select the band/station that you want to have stored.
- 2 Hold down preset station number [P 1] - [P 6] that you want to use for the station, for two seconds or more.

NOTE

You can store 6 stations in each of the FM1, FM2, FM3, and AM (MW and LW) bands.

► Recalling a Preset Station

Touch the preset station number [P 1] - [P 6] for the desired station. The number of the recalled station is displayed.

► Switching to the PTY Search Screen

Touch [PTY] to switch the PTY search screen. (Page 21)

► Switching to the Tuner Control Screen (Shift)

Touch [◀] to switch to the tuner control screen (Shift).

Tuner Control Screen (Shift)



► Auto Memory Entry

You can automatically store all the receivable frequencies in the band currently being listened to, and then recall them with the touch of a button later. This function is especially useful when you are travelling and do not know what stations are available. Up to 6 frequencies can be stored this way.

- 1 Select the band for auto memory entry.
- 2 Touch [AME].
[►►] and [◀◀] blink.
- 3 Touch [►►] or [◀◀] to start auto memory entry.
The preset station numbers [P1] - [P6] are shown in order.
When all the stations in a certain band are stored in the preset memory, the auto memory entry stops. The tuner then plays the last station received.

NOTE

- When the AF function is turned on whilst auto memory entry takes place, only RDS stations (i.e., stations with RDS capability) are stored. RDS stations that have been preset for FM1 cannot also be preset in FM2 or FM3.
- When the local seek function is turned whilst auto memory entry takes place, stations with poor reception are not stored.
- When the Traffic Information function is on, only the local traffic information station frequency will be stored.

► Turning the Monaural Reception On/Off

When poor stereo reception is experienced, this function will reduce noise and improve listening conditions.

Touch [MONO] to switch the monaural reception on and off.
The MONO indicator is displayed when monaural reception is on.

► Selecting the Tuning Mode

You can choose from three tuning modes: auto seek, preset station seek, and manual. The "AUTO1" indicator is displayed when auto seek tuning is selected, and the "AUTO2" indicator is displayed when preset station seek tuning is selected.

Each time you touch [SEEK], the mode switches as follows.

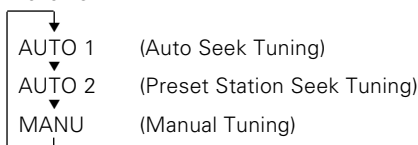

► Turning the Local Seek Function On/Off

With the local seek function turned on, auto seek tuning skips stations with relatively poor reception.

Touch [LO.S] to switch the local seek function on and off.
The LO.S indicator is displayed when the local seek function is on.

Tuner Control Screen (Shift)

► Traffic Information Function

You can listen to traffic information. If you are listening to discs, they will continue playing until a traffic bulletin is broadcast.

Turning TI function On/Off:

Touch [TI] on the control screen to turn the function on and off.

When the function is on, the TI indicator is turned on. When a traffic information station is received, the TI indicator blinks.

If you are listening to a disc when a traffic bulletin begins, playback will be interrupted. When the bulletin ends or poor reception causes signal losses, the disc will continue to play again.

Switching to a Different Traffic Information Station:

Use [◀◀] / [▶▶] to make an auto seek of the TI stations in a certain band.

NOTE

- When you are listening to a disc, you cannot change to another TI station.
- When the auto TP seek function is turned on and reception starts to weaken, the tuner automatically seeks stations with better reception.
- If you are tuned to a station that is not a traffic information station itself but which provides EON services, you can still have traffic information received.

► Presetting the Volume for Traffic Information/News

Preset the volume to be used when traffic information/news starts to be broadcast.

- 1 Tune into the station for which you want to set the volume.
- 2 Adjust the volume to the desired level.
- 3 Keep touching [TI VOL] for two seconds or more.
The volume level that the data has been stored. Future traffic information broadcasts are heard at the preset level.

NOTE

- The volume cannot be lowered by this function during tuner reception. The volume is only set when it is louder than the listening volume of the tuner.
- You can arrange only to listen to traffic information /news bulletins with at preset volume with the volume set at minimum.

► Returning to the Tuner Control Screen (Main)

Touch [◀] to return to the tuner control screen (Main).

PTY Search Screen



Conduct auto seek tuning only on those stations with selected kinds of programmes.

NOTE

You cannot use this function whilst the traffic information function is turned on.

► Changing the Display Language to French or German

In the PTY mode, touch [LANG.] to display the name of the language currently used.

► Selecting the Type of Programme to be Received

- 1 Touch either [▼] or [▲] repeatedly to select the type of programme in the list.
- 2 Touch the list to select the type of programme you want to listen to.

News	News	S
Current Affairs	Current Affairs	S
Information	Information	S
Sports	Sports	S
Education	Education	S
Drama	Drama	S
Culture	Culture	S
Science	Science	S
Varied Speech	Varied Speech	S
Pop Music	Pop Music	M
Rock Music	Rock Music	M
Easy Listening	Easy Listening	M
Light Classics M	Light Classics Music	M
Serious Classics	Serious Classics	M
Other Music	Other Music	M
Weather & Metr	Weather & Metr	S
Finance	Finance	S
Children's progs	Children's programs	S
Social Affairs	Social Affairs	S
Religion	Religion	S
Phone In	Phone In	S
Travel & Touring	Travel & Touring	S
Leisure & Hobby	Leisure & Hobby	S
Jazz Music	Jazz Music	M
Country Music	Country Music	M
National Music	National Music	M
Oldies Music	Oldies Music	M
Folk Music	Folk Music	M
Documentary	Documentary	M
All Speech	All Speech	S
All Music	All Music	M

(S: Speech, M: Music)

► Seeking the Selected Programme Type

Touch [►►] to make a seek of frequencies with your selected type of programme. If your selected type of programme is found, the name of the station is displayed and the station is tuned into.

► Cancelling the PTY Search Screen

Touch [CTRL] to return to the source control screen.

DAB Tuner Control Function

DAB Setup Screen

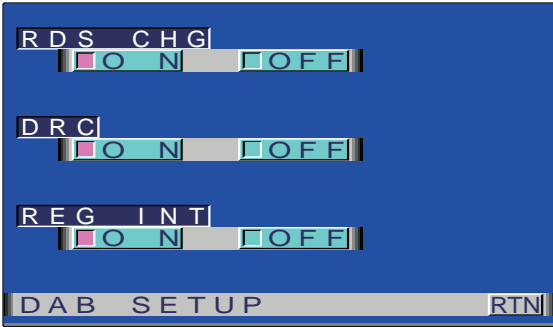

► Automatic Switching from DAB to RDS [RDS CHG]

Touch [ON] or [OFF] to switch the function on and off.

- ON : Automatic DAB-RDS switching function is turned on
- OFF : Automatic DAB-RDS switching function is turned off

► Dynamic Range Control [DRC]

Touch [ON] or [OFF] to switch the DRC function on and off.

- ON : Dynamic range control is turned on
- OFF : Dynamic range control is turned off

► Restricting the DAB Region (Region Restrict Function) [REG INT]

Touch [ON] or [OFF] to switch the Region restrict function on and off.

- ON : Region restrict function is turned on
- OFF : Region restrict function is turned off

DAB Control Screen (Main)



► Switching the Ensemble

In Auto Ensemble Seek Mode (AUTO1)

Each time you touch [►►], Auto Ensemble Seek begins toward higher frequencies, and each time you touch [◀◀], seeking begins toward lower frequencies.

In Preset Ensemble Seek Mode (AUTO2)

Touch [►►] to move to the next preset station (i.e., the one with the next highest number), and [◀◀] to move to the last preset station (i.e., the one with the next lowest number).

In Manual Seek Mode (MANU)

Touch [►►] to increase the receiving frequency by one step or each touch [◀◀] to decrease it by one step.

► Selecting the Type of Programme to be Received

Touch [S-] or [S+] repeatedly to select the type of programme you want to listen to.

NOTE

See KTC-959DAB Instruction Manual for type of programme.

► Service Preset Memory

- 1 Touch [BAND] to select the preset band.
Each time you touch [BAND], the preset band switches between the DAB1, DAB2 and DAB3.
- 2 Receive the service to be preset.
- 3 Hold down preset number [P1] - [P6] for two seconds or more to preset the service.

The service is preset when the number of the button blinks once.

Recalling a Preset Service:

Touch [BAND] to select the preset band, and press the desired preset number [P1] - [P6]. The number of the pressed button is shown in the display.

► Turning the DAB PTY Search On/Off

Touch [PTY] to switch the DAB PTY search on and off.

► Switching to the DAB Control Screen (Shift):

Touch [◀] on the DAB control screen (Main) to switch to the DAB control screen (Shift).

► Switching to the Next Source Mode

Touch the mark located at the lower side of ▼ to switch to the next source control screen.

► Switching to the Previous Source Mode

Touch the mark located at the upper side of ▲ to switch to the previous source control screen.

► Switching to the Menu Screen

Touch [MENU] to switch to the menu screen.

DAB Control Screen (Shift)



▶ Selecting the Seek Mode

Each time you touch [SEEK], the mode switches as follows:

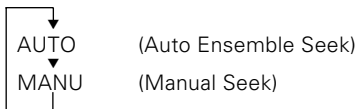

▶ Auto Memory Entry

You can automatically store all the receivable frequencies in the band currently being listened to, and then recall them with the touch of a button later. This function is especially useful when you are travelling and do not know what stations are available. Up to 6 frequencies can be stored this way.

- 1 Select the band for auto memory entry.
- 2 Touch [AME].
[►►] and [◀◀] blink.
- 3 Touch [►►] or [◀◀] to start auto memory entry.
The preset station numbers [P1] - [P6] are shown in order.

When all the stations on a certain band have been stored in the preset memory, the auto memory entry stops. The tuner then plays the last station received.

Recalling a Preset Station:

Touch the preset station number [P1] - [P6] for the desired station. The number of the recalled station is displayed.

▶ Dual Channel Audio Switching

The Dual Channel Audio can be switched between Main and Sub.

Touch [SUB] to switch the dual channel audio between main and sub.

NOTE

When "SUB" is selected, the sub audio continues to be received even when the service is switched to another, provided that the new service also broadcasts a dual channel audio programme.

▶ Primary/Secondary Switching

Each time you touch [P/S], the service switches as follows:

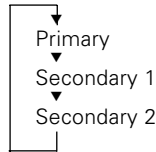

▶ Presetting the Volume Level for Traffic Information/News

Preset the volume level to be used when traffic information/news start to be broadcast.

- 1 Tune into the station for which you want to set the volume.
- 2 Adjust the volume to the desired level.
- 3 Keep touching [TI VOL] for two seconds or more.

The volume level that has now been stored. Future traffic information/news broadcasts are heard at the preset level.

NOTE

- The volume level cannot be lowered by this function during tuner reception. The volume is only set when it is louder than the current listening volume of the tuner.
- When the volume level is set to minimum, it is still possible to listen to traffic information bulletins at preset volume.

▶ Returning to the DAB Control Screen (Main)

Touch [◀] to return to the DAB control screen (Main).

Disc Changer Control Function

Disc Changer Control Screen (Main)



► Pausing and Restarting CD Play

Touch [►||] to make the disc pause.
Touch [►||] again to start play again.

NOTE

When one disc has finished playing its last track, the next disc in the changer starts playing. When the last disc in the changer has finished, the player returns to the first disc and starts playing it.

► Track Search

Search forwards or backwards through the tracks on the disc until you reach the one that you want to listen to.

Making a Forward Track Search:

Touch [►▶] to display the desired track number. Touch once to fast forward to the next track, twice to fast forward to the track after that, and so forth. Play starts at the beginning of the displayed track number.

Making a Reverse Track Search:

Touch [◀◀] to display the desired track number. Touch once to search back to the beginning of the current track, twice to search back to the beginning of the previous track, and so forth. Play starts at the beginning of the displayed track number.

► Fast Forwarding and Reversing Disc Play

Fast Forwarding Disc Play:

Hold down on [►▶].
Release your finger to play the disc at that point.

Reversing Disc Play:

Hold down on [◀◀].
Release your finger to play the disc at the point.

► Disc Search

Search forwards or backwards through the discs in a disc changer until you reach the one that you want to listen to.

Making a Forward Disc Search:

Touch [D +] to display the desired disc number. Each time [D +] is touched, the displayed disc number increases by one. Play starts at the beginning of the displayed disc.

Making a Reverse Disc Search:

Touch [D -] to display the desired disc number. Each time [D -] is touched, the displayed disc number decreases by one. Play starts at the beginning of the displayed disc.

NOTE

"LOAD" is displayed when discs are being exchanged on the disc changer.

► Track Repeat Function

Repeat playing the current track.

Turning Track Repeat Play Function On/Off:

Touch [REP] to switch the track repeat play function on and off.
The REP indicator is displayed when the track repeat play function is turned on.

NOTE

The track repeat play function is cancelled when you stop playing the disc.

► Disc Repeat Function

Repeat playing the current disc.

Turning Disc Repeat Play Function On/Off:

Touch [DREF] to switch the disc repeat play function on and off.
The DREF indicator is displayed when the disc repeat play function is turned on.

NOTE

The disc repeat play function is cancelled when you stop playing the disc.

► Track Scan Function

Successively play the beginning of each track on a disc until you find the one that you want to listen to.

Turning Track Scan Function On/Off:

Touch [SCN] to switch the track scan function on and off.
The SCN indicator is displayed when the track scan function is turned on.
The first 10 seconds of each track are played, and the tracks are played in order.

Stopping to Listen to the Track Being Scanned:

Touch [►||] or [SCN] again to stop the scan and keep on listening to a track normally.

NOTE

- The track scan function is cancelled when you stop playing a disc.
- The track scan function only scans each track on a disc once.

► Disc Scan Function

Successively play the beginning of each disc on a changer until you find the one that you want to listen to.

Turning Disc Scan Function On/Off:

Touch [DSCN] to switch the disc scan function on and off.
The DSCN indicator is displayed when the scan function is turned on.
The first 10 seconds of each disc are played, in the order in which they are loaded on the changer.

Stopping to Listen to the Disc Being Scanned:

Touch [►||] or [DSCN] again to stop the scan and keep on listening to the disc normally.

NOTE

- The disc scan function is cancelled when you stop playing a disc.
- The disc scan function only scans each disc on the changer once.
- "LOAD" is displayed when discs are being exchanged on the disc changer.

► Track Random Play Function

Play all the tracks on the current disc in random order.

- 1 Touch [RDM] to switch the random play function on and off.
The RDM indicator is displayed when the random play function is turned on.
The display of the track number changes continuously as the next track is being selected.
When the track has been selected, play starts.
- 2 To change the track being heard, touch [►►].
Another track is selected and played.

NOTE

The random play function is cancelled when you stop playing a disc.

► Magazine Random Play Function

Play the tracks on all the discs in the disc changer in random order.

- 1 Touch [MRDM] to switch the magazine random play function on and off.
The MRDM indicator is displayed when the magazine random play function is turned on.
The display of the disc and track numbers change continuously as the next track is being selected.
When the disc/track has been selected, play starts.
- 2 To change the track being heard, touch [►►].
Another disc/track is selected and played.

NOTE

- The magazine random play function is cancelled when you stop playing a disc.
- The time needed for random selection depends on the number of discs loaded in the disc magazine.

► Switching to the Disc Changer Control Screen (Shift)

Touch [] to switch to the disc changer control screen (Shift).

► Switching to the Next Source Mode

Touch the mark located at the upper side of ▼ to switch to the next source control screen.

► Switching to the Previous Source Mode

Touch the mark located at the lower side of ▲ to switch to the previous source control screen.

► Switching to the Menu Screen

Touch [MENU] to switch to the menu screen.

Disc Changer Control Function

Disc Changer Control Screen (Shift)



▶ Selecting the Name or Title Display for Discs

Each time you touch [TITLE], the display during disc play switches as follows:

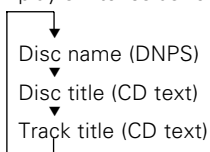

NOTE

- You can give names to discs through the presetting disc name function.
- If you try to display the name of a disc that does not have one, "NO NAME" is displayed instead.
- If you try to display the title of a disc that does not have one, "NO TEXT" is displayed instead.

▶ To Scroll Manually

Touch [SCRL] to display the disc title or the track title. The titles will be displayed in one scrolling display.

▶ Selecting the Time Display for CDs

Each time you touch [TIME], the time display during disc play switches as follows:

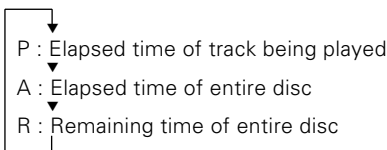

▶ Switching to the Disc List Screen

Touch [LIST] to switch the disc list screen. (Page 26)

▶ Switching to the Name Set Screen

Touch [NAME] to switch the name set screen. (Page 27)

NOTE

You cannot operate unless the parking brake is set.

▶ Returning to the Disc Changer Control Screen (Main)

Touch [◀] to return to the disc changer control screen (Main).

Disc List Screen

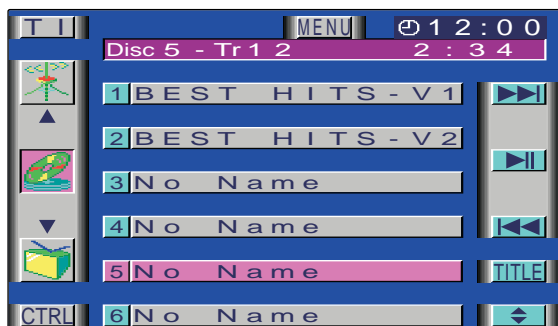

▶ Changing to the Disc List

Each time you touch [◀], the disc list switches between the disc 1-6 and disc 7-10.

NOTE

Depending on the connected model, a 6-disc changer might be identified as a 10-disc changer.

▶ Selecting the Disc

Touch the disc number or name in the list for the desired disc. The number of the changed disc is displayed.

▶ Switching the Display for Discs

Touch [TITLE] to switch the display between the disc title and disc name in the list.

▶ Returning to the Source Control Screen

Touch [CTRL] to return to the source control screen (Shift) .

Name Set Screen



► Station Name Preset (SNPS) /Disc Name Preset (DNPS)

1 If the cursor is in the desired character input position, go on to step 4. If not, touch either [◀] or [▶] to move the cursor to the desired position. Touching [◀] moves the cursor to the left and touching [▶] moves it to the right.

2 Touch [▼] or [▲] to switch the character lists.

NOTE

When all characters are displayed on the character list, [▼] and [▲] do not appear.

3 Touch [A B], [a b], [1 2] or [Ä ä] to switch the character lists.

4 Touch a character.

5 Continue steps 1 and 4 until all the characters have been input for the name.

NOTE

- You can enter up to 12 characters for each name.
- To enter a space, touch [SPC]. A blank is inserted and the cursor moves to the right.

6 Touch [OK] to finish name entry and leave the name preset mode.

NOTE

- If you want to change the name of a station, first display the name of the station (following step 1), then change the letter(s) that you by following steps 2, and 4.
- You can assign names for up to 30 TV stations.
- You can only store names for up to 100 CDs. If you store the name for an 101st CD, the first one will be erased automatically.
- CDs are identified by their total length and number of tracks. If you play another CD that happens to have exactly the same specifications as another CD whose name is stored, the wrong name may be displayed.

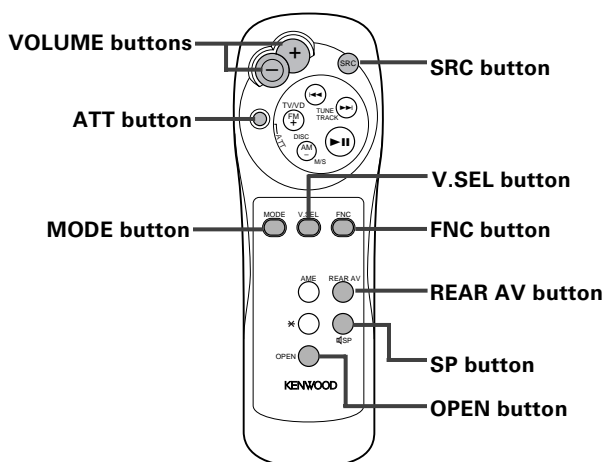

Basic Source Control Function

• SRC button

Each time you press the SRC button, the source mode switches as follows:

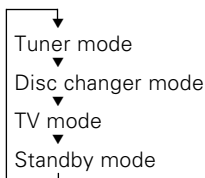

NOTE

- The mode switches to the next mode from any mode which cannot be used.
- The tuner mode and disc changer mode will differ depending on the unit that is connected.

• VOLUME buttons

Press the ⊕ button to increase the volume.
Press the ⊖ button to decrease the volume.

• ATT button

Turn down the volume quickly. To return the volume to its original level, press the button again.

• SP button

Switch to the built-in speaker mode.

• OPEN button

Open/Close the monitor.

NOTE

The "✕" button cannot be used.

Visual Function

• V.SEL button

Each time you press V.SEL button, the image video will switch between the navigation, television and video.

• MODE button

Each time you press MODE button, the screen mode switches between the full, zoom, just, cinema and normal.

• FNC button

Press the FNC button to switch the source control screen.
Each time you press FNC button, the back picture in the source control screen changes.

• REAR AV button

Each time you press REAR AV button, the AV output mode switches between the normal, television and video 2 (from the front AV-IN terminal).

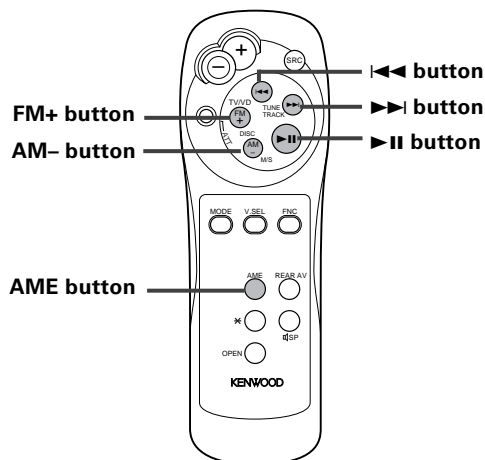

TV Control Function

- **▶|| button**
Each time you press the ▶|| button, the tuning mode switches to auto 1, to auto 2 and manual.
- **TUNE buttons**
Press the ◀◀ button to make decreasing seeks.
Press the ▶▶ button to make increasing seeks.
Start the auto memory entry during the auto memory entry mode.
- **FM+ button**
Switch between the TV1, TV2, video1 and video2.
- **AME button**
 - 1 Selects the band for auto memory entry.
 - 2 Press the AME button.
 - 3 Press the ▶▶ button or ◀◀ button to start auto memory entry.

Tuner Control Function

- **▶|| button**
Each time you press the ▶|| button, the tuning mode switches to auto 1, auto 2 and manual.
- **TUNE buttons**
Press the ◀◀ button to make decreasing seeks.
Press the ▶▶ button to make increasing seeks.
- **FM+ button**
Select and switch between the FM1, FM2 and FM3 bands.
- **AM- button**
Select the MW and LW bands.

Disc Changer Control Function

- **▶|| button**
Press the ▶|| button to make the disc pause.
Press the ▶|| button to start play again.
- **TRACK buttons**
Press the ◀◀ button to search through the tracks backwards.
Press the ▶▶ button to search through the tracks forwards.
- **DISC buttons**
Press the AM- button to search through the discs backwards.
Press the FM+ button to search through the discs forwards.

Accessories

External view

..... Number of items

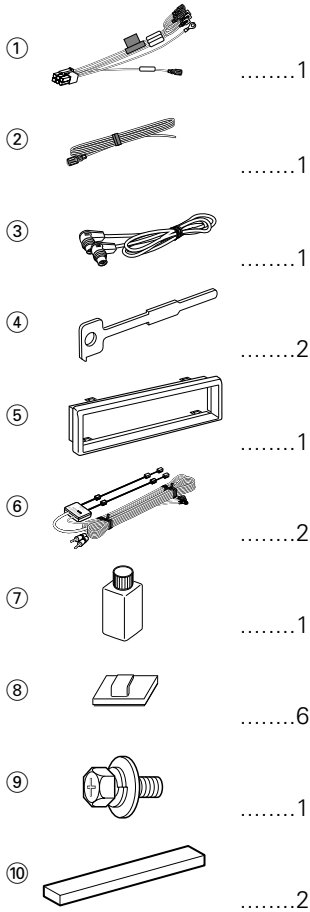

▲ CAUTION

The use of any accessories except for those provided might result in damage to the unit. Make sure only to use the accessories shipped with the unit, as shown above.

Installation Procedure

1. To prevent short circuits, remove the key from the ignition and disconnect the ⊖ terminal of the battery.
2. Make the proper input and output cable connections for each unit.
3. Connect the wiring harness cables in the following order: ground, battery, ignition.
4. Connect the wiring harness connector to the unit.
5. Install the unit in your car.
6. Reconnect the ⊖ terminal of the battery.
7. Press the reset button. (See p. 4)

▲ CAUTION

- If your car's ignition does not come with an ACC position, connect the ignition cables to a power source that can be turned on and off with the ignition key. If you connect the ignition cable to a power source that receives a constant voltage supply, as with battery cables, the battery may die.
- If the fuse blows, first make sure that the cables have not caused a short circuit, then replace the old fuse with one with the same rating.
- Do not let unconnected cables or terminals touch metal on the car or anything else conducting electricity. To prevent short circuits do not remove the caps from unused terminals or from the ends of the unconnected cables.
- After the unit is installed, check whether the brake lamps, blinkers, wipers, etc. on the car are working properly.
- Insulate unconnected wires with vinyl tape or other similar material.
- Mount the unit so that the mounting angle is 30° or less.

Installation of Monitor Unit

▲ CAUTION

When mounting the main unit after checking the operation, close the monitor first.

NOTE

- Move the fittings on both sides to suit the installation chassis and select the embedding position from among the 3 positions. (● : Fixing screw)
- When the fittings are set closest to the front (i.e., the embedding position is farthest back), use the hard rubber frame (Accessory ⑤).

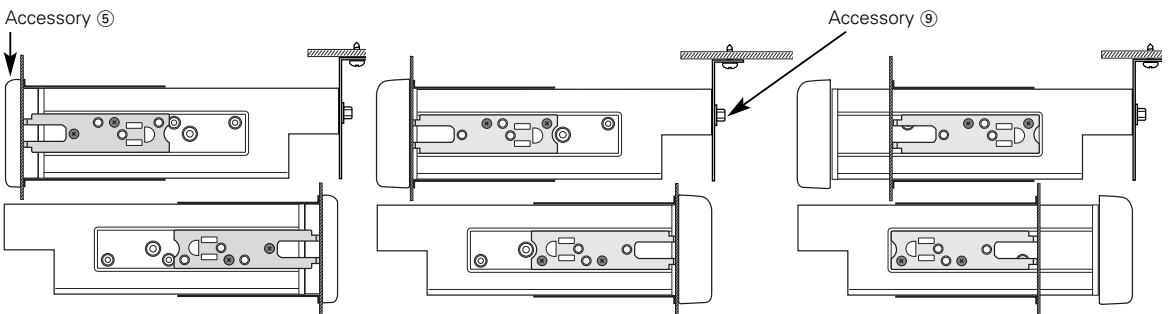

On cars where there is no compartment in the centre for installing a car audio unit:

Use the spacer (Accessory ⑩) to affix the centre unit sleeve and the sleeve attached to the main unit in such a way that they are correctly aligned both depthwise and horizontally.

On cars lacking a centre compartment

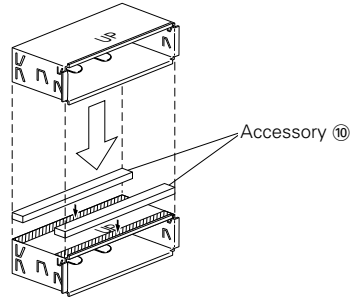
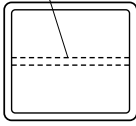
**Removing Unit****■ Removing the Hard Rubber Frame**

- 1 Engage the catch pins on the removal tool and remove the two locks on the lower level. Lower the frame and pull it forward as shown in the figure.

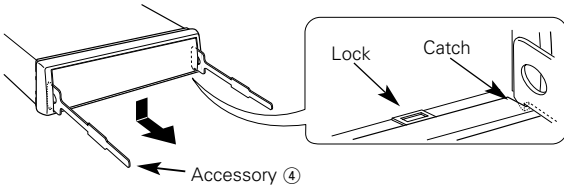

- 2 When the lower level is removed, remove the upper two locations.

NOTE

The frame can be removed from the top side in the same manner.

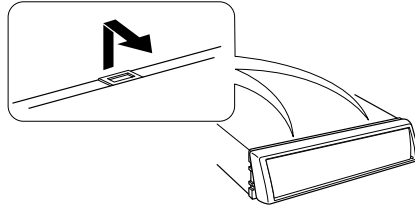
**■ Removing the Unit**

- 1 Refer to the section "Removing the Hard Rubber Frame" and then remove the hard rubber frame.
- 2 Remove the Hex-head screw (Accessory ⑨) with integral washer (M4x8) on the back panel.

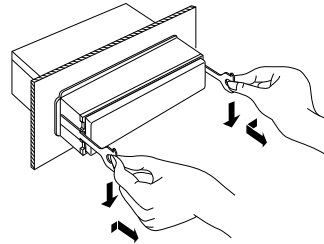
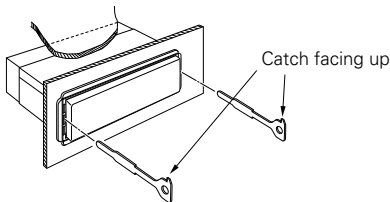

- 5 Pull the unit all the way out with your hands, being careful not to drop it.

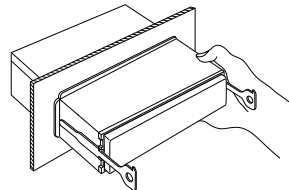

- 3 Insert the two removal tools deeply into the slots on each side, as shown.

▲ CAUTION

Be careful to avoid injury from the catch pins on the removal tool.

- 4 Lower the removal tool toward the bottom, and pull out the unit halfway whilst pressing towards the inside.

Connections

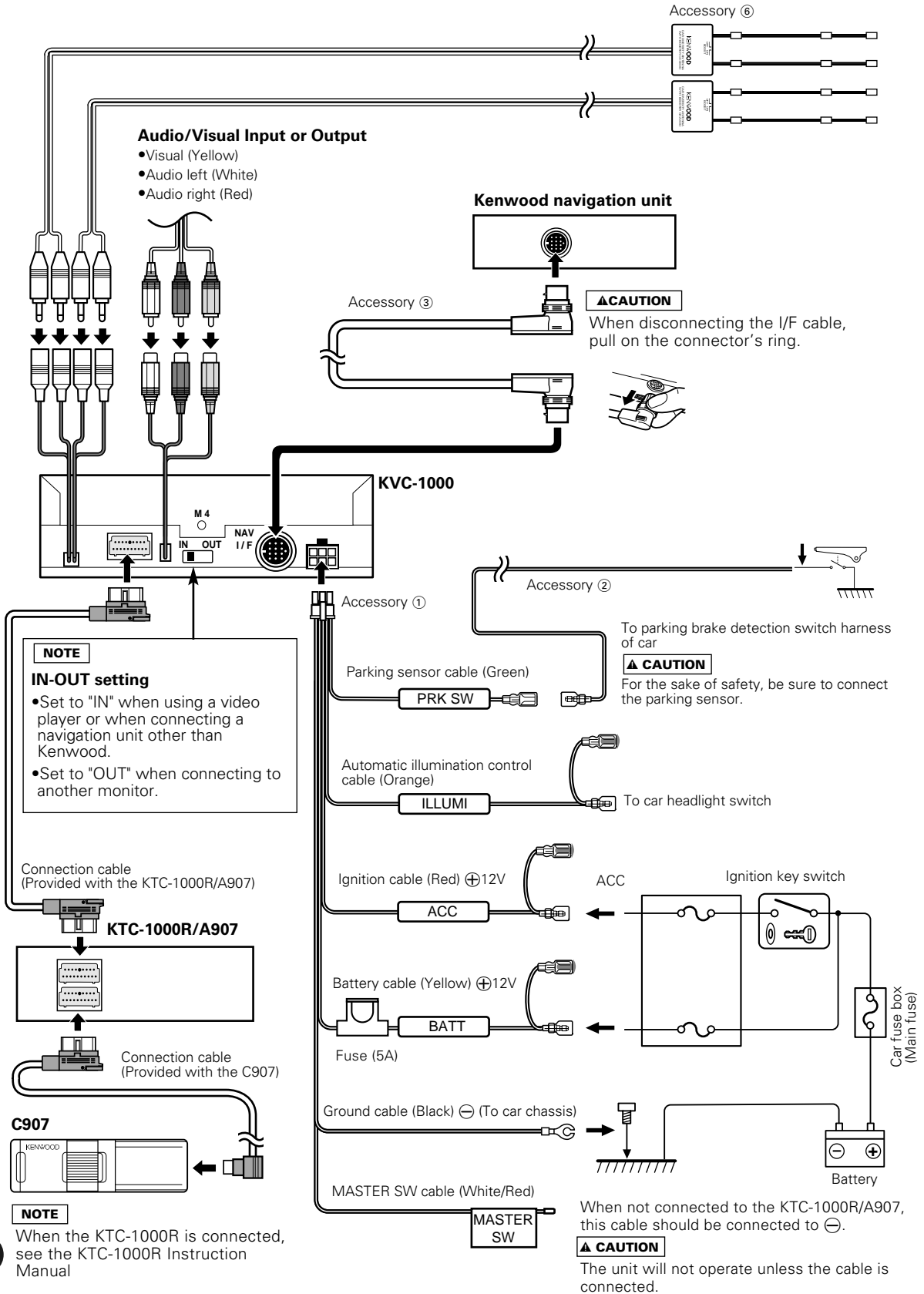

Connecting and Install Antenna Units

■ Connection of Antenna Unit

▲ CAUTION

Incar antennas have a lower reception sensitivity than antennas intended for outside mounting. The picture may not appear or may be disturbed if the signal in your area is weak.

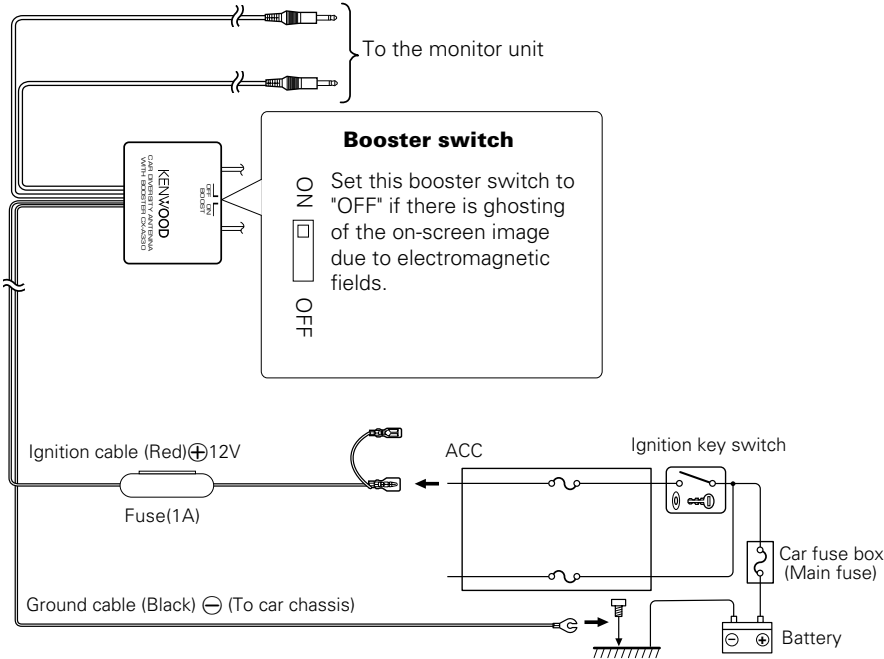

■ Installation for Antenna Unit

- Attach the antenna to the inner glass surface of the rear window using double-sided tape. Carefully check the installation location as the tape can only be stuck on once.
- If the surface temperature of the glass of the rear window is low, warm it by turning on the power of the rear defogger. A cold window glass surface will weaken the adhesive strength of the double-sided tape. Also, if installation inside the cabin is performed on a day with high humidity or when it is raining, the high humidity level will weaken the adhesive strength of the double-sided tape.
- Do not install the antenna in a location where it may obstruct the field of view during driving, such as on the windshield.

- 1 Check the location where the antenna is to be attached. Clean off any grease or dirt from the installation location using the supplied glass cleaner, clean the area with water and allow to dry.

▲ CAUTION

Clean the glass thoroughly as failure to clean the glass can not only weaken the adhesive strength of the double-sided tape, but may also cause it to come loose.

- 2 Remove the protective strips from the antenna parts and the back of the antenna unit.
- 3 Attach the double-sided tape of the antenna parts and the antenna unit to the rear windshield glass. Attach the double-sided tape by firmly pressing down from the top. Secure cables using the supplied clampers.
- 4 After attaching the antenna with the double-sided tape, allow it to sit undisturbed for 24 hours. Take care not to apply force to the antenna or allow it to get wet during this time.
- 5 Wire the antenna cable to the hideaway unit.

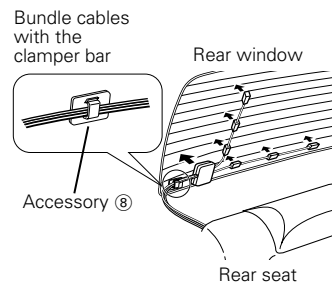
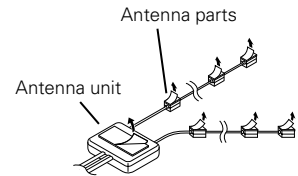

Troubleshooting Guide

What might appear to be a malfunction in your unit may just be the result of slight misoperation or miswiring. Before calling service, first check the following table for possible problems.

PROBLEM	POSSIBLE CAUSE	SOLUTION
The power does not turn on.	The fuse has blown.	After checking for short circuits in the cables, replace the fuse with one having the same rating.
	No ACC position on vehicle ignition.	Connect the same cable to the ignition as the battery cable.
Nothing happens when the buttons are pressed.	The computer chip in the unit is not functioning normally.	Press the reset button on the unit (see page 4).
The monitor does not open/close.	The parking brake is not engaged.	For safety reasons, the monitor does not open while the vehicle is moving. Engaging the parking brake.
No television/ video image appears.	The unit is not connected to the parking brake detection switch.	Make proper connections according to "Connections" (See page 32).
	The parking brake is not engaged.	For safety reasons no television/ video images are displayed while the vehicle is moving. Engaging the parking brake will cause images to be displayed.
The screen is dark.	The unit is in a location where temperature is low.	If the temperature of the monitor unit drops, the screen may appear darker when power is first turned on due to the characteristics of a liquid crystal panel. Wait a while after turning power on for the temperature to rise. Normal brightness will return.
The screen does not darken when the vehicle's lights are turned on	The unit is set to auto dimmer.	When the unit is set to auto dimmer, it is not linked to the vehicle's light switch.
	The illumination cable has not been connected. (If manual dimmer is set)	Make proper connections according to "Connections" (See page 31).
AM/FM radio reception is poor and/or there is noise.	The TV antenna and vehicle's radio antenna are too close.	<ul style="list-style-type: none"> • Separate the two antennas as far as possible. • Turn off the main unit.

The following indications are used to inform you that there is a problem with the connections of the system.

- BUS-E50: Two or more the KTC-1000R or A907 are connected.
 BUS-W02: The No. switch of the connected disc changers is set to the same number (1 or 2) for both units.
 ⇒ Set the No. switch of one disc changer to "1" and the other unit to "2" to enable proper use.
 BUS-W08: Two or more monitors are connected to the BUS terminal.

The following messages are displayed when certain problems are occurring in your system. Take the recommended actions.

- EJECT No disc magazine has been loaded in the changer. The disc magazine is not completely loaded.
 ⇒ Load the disc magazine properly.
 No CD in the unit.
 ⇒ Insert the CD.
- NO DISC No disc has been loaded in the disc magazine.
 ⇒ Load a disc into the disc magazine.
- E-04 No disc has been loaded in the disc magazine.
 ⇒ Load a disc into the disc magazine.
 The CD is quite dirty. The CD is upside-down. The CD is scratched a lot.
 ⇒ Clean the CD and load it correctly.
- BLANK Nothing has been recorded on the MD.
 ⇒ The next MD will automatically be played.
- NO TRACK No tracks are recorded on the MD, although it has a title.
 ⇒ The next MD will automatically be played.
- E-99 Something is wrong with the disc magazine. Or the unit is malfunctioning for some reason.
 ⇒ Check the disc magazine. And then press the reset button on the unit. If the "E- 99" code does not disappear, consult your nearest service center.
- HOLD The protective circuit in the unit activates when the temperature inside the automatic disc changer exceeds 60°C (140°F), stopping all operation.
 ⇒ Cool down the unit by opening the windows or turning on the air conditioner. As the temperature falls below 60°C (140°F), the disc will start playing again.

Specifications

Specifications subject to change without notice.

Monitor Section

Picture size6.5 inches wide
 142.6(W) × 80.7(H) mm
 Display systemTransparent TN LCD panel
 Drive system.....TFT active matrix system
 Number of pixels336.960 pixels (480 H × 234 V × RGB)
 Effective pixels99.99%
 Pixel arrangement.....RGB striped arrangement
 Back lightingCold cathode tube
 Built-in speaker1 W (40mm × 20mm)

TV Tuner Section

Colour systemPAL/SECAM
 NTSC/PAL (Video)
 Channel selection system.....PLL frequency synthesizer system
 Demoduration systemSplit carrier system

Television system		PAL-B/G	PAL-I	SECAM-L	SECAM-D/K	SECAM-B/G
Channel converge	VHF	2 - 12ch A - Hch	A - Jch	2 - 10ch	1 - 12ch	2 - 12ch
	UHF	21 - 69ch				

Antenna input4-ch diversity (75 Ω /3.5 ø minijack)
 External video input level (miniplug).....1 Vp-p/75 Ω
 External audio max. input level (miniplug).....1 V/22 KΩ
 External video input level (RCA jacks)1 Vp-p/75 Ω
 External audio max. input level (RCA jacks)1 V/22 KΩ
 Video output level (RCA jacks)1 Vp-p/75 Ω
 Audio output level (RCA jacks).....500 mV/1 KΩ

General

Operating voltage14.4 V DC (11 to 16 V)
 Consumed current2.0 A
 Operational temperature range-10°C to +60°C
 Storage temperature range-20°C to +85°C
 Size180(W) × 50(H) × 182(D) mm
 7-1/16(W) × 1-15/16 (H) × 7-3/16(D) inch
 Installation size178(W) × 50(H) × 165(D) mm
 7(W) × 1-15/16(H) × 6-1/2(D) inch
 Weight1.8 kg(4 LBS)

TV Antenna Unit

Output impedance75 Ω /3.5 ø miniplug
 Operating voltage12 V DC
 Consumed current1.0 A
 Cable length5 m
 Size50(W) × 14.5(H) × 500(D) mm
 1-15/16(W) × 9/16(H) × 19-11/16(D) inch
 Weight70 g (x2)

Although the effective pixels for the liquid crystal panel is given as 99.99% or more, 0.01% of pixels may not light or may light incorrectly.