

Northstar 941X Reference Manual

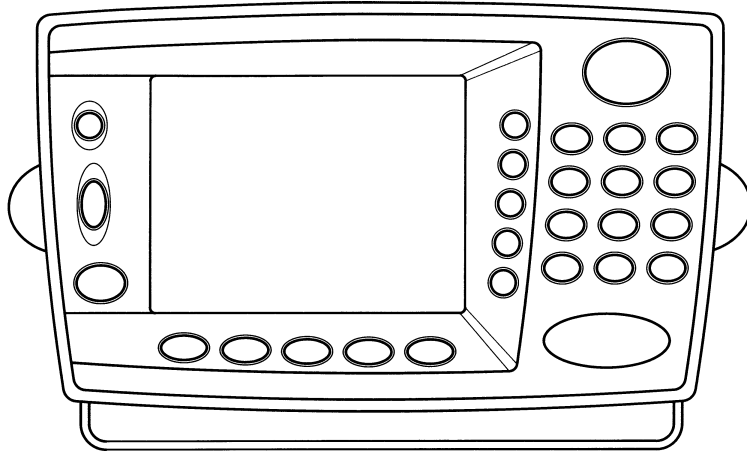

SOFTWARE VERSION 2.05

NORTHSTAR 
TECHNOLOGIES • A Division of CMC Electronics, Inc.

30 SUDBURY ROAD
ACTON, MASSACHUSETTS 01720
(508) 897-6600

WARRANTY

Northstar Technologies, a Division of CMC Electronics, Inc., warrants its products to be free from defects in material and workmanship for a period of two (2) years from the date of shipment to an authorized dealer. This warranty applies to the original purchaser or subsequent owner.

This warranty covers repair and/or replacement, at our option, of any part or parts found to be defective, provided such defects in our opinion are due to faulty material or workmanship and are not caused by tampering, abuse, or normal wear.

All warranties are F.O.B.: Northstar Technologies
30 Sudbury Road
Acton, Massachusetts 01720

This warranty applies only to products in normal use. It does not apply to units or circuit boards defective due to improper installation, physical damage, tampering, lightning or other electrical discharge, receivers or mainframes subjected to fresh water or saltwater immersion*, units with altered serial numbers, or units repaired by unauthorized persons or in violation of Northstar service procedures.

The foregoing are the only warranties expressed or implied. No other warranty exists.

Northstar assumes no responsibility for any consequential losses or damages of any nature with respect to any products or services sold, rendered, or delivered.

* Certain Northstar control heads are warranty protected against damage due to water leakage, provided the head has not been tampered with.

IMPORTANT NOTICE

Although Northstar products are designed to be very useful navigation tools, they are not substitutes for good seamanship. The prudent navigator should never rely on any single device as the sole source of navigation guidance. Exercise caution and good judgment whenever underway.



CONTENTS



1	The Northstar 941X	
	Introduction	2
	Upon First Start-up	2
	Using This Manual.....	3
	941X Features	4
	941X Functions	5
	Comparing GPS and Loran	5
	Mounting Basics	9
	Special Functions.....	9
	The Display Screen	10
Interfacing Capability.....	11	

2	Using the Controls	
	POWER Key.....	14
	CONTRAST Key.....	14
	SAVE/MOB Key.....	15
	Function Keys	16
	Menu Keys.....	17
	Cursor Keys.....	17
	Keypad	17
Special Display Windows	18	

3	Basic Navigation	
	Displaying Position, Heading & Speed	22
	Position Plotter	22
	Using GPS	25
	Using DGPS	26
	Using Loran	30
Using Phantom Loran	32	

4 Creating Waypoints and Routes

Entering Data.....	36
Creating Waypoints	37
Avoidance Areas	39
Waypoint Lists	41
Coordinate Options	42
Updating Waypoint Coordinates	42
Editing Waypoints	43
Transferring Waypoints to a PC.....	44
Creating Routes	44
Saving a Route	47
Changing a Route.....	50

5 Waypoint & Route Navigation

Quick-Start Waypoint.....	54
Navigating to Waypoints.....	55
Navigating Along Routes.....	59
Restarting the Course Line.....	61

6 The NAV LOG Function

What NAVLOG Does	64
Logging Your Trip.....	65
Changing Your Trip	65
Adding Waypoints to the Trip.....	66

7 Other Special Functions

Alarms	68
Screen Backlighting	71
TideTrack™	71
Internal Differential Beacon Receiver	74

8 Customizing the 941X

Time of Day	78
Display Options	78
Navigation Options	82
Receiver Options	87
Port Setup Options	90
Service Options	91
Geodetic Datum	94

9 Installation and Interfacing

Mounting the 941X	100
Wiring the 941X System	102
Antenna Location	104
DGPS Antenna Coupler (ACU)	108
Interfacing the 941X	112
Programming the Output Ports	115

Appendix (Specifications)	129
Glossary	135
Index	138

Figures

FIGURE 1—MAX. POSITION VARIANCES WITH UNCORRECTED GPS.....	8
FIGURE 2—YOKE MOUNT DRILLING DIMENSIONS.....	102
FIGURE 3—REAR CONNECTORS	103
FIGURE 4—941X GPS-ONLY ANTENNA (AN145 & AN150).....	105
FIGURE 5—941X COMBO GPS/DGPS ANTENNA (AN190).....	105
FIGURE 6—STRIPPING THE COAX CABLE JACKET	107
FIGURE 7—FLARED CABLE BRAID	108
FIGURE 8—COMPLETED BNC CONNECTOR	108
FIGURE 9—ACU ASSEMBLY	110
FIGURE 10—PL 259 (UHF) CONNECTOR.....	111
FIGURE 11—INTERFACE CONNECTOR (MATING SIDE).....	113
FIGURE 12—200 PPNM OUTPUT BLOCK DIAGRAM.....	115
FIGURE 13—941X DIMENSIONS	132

Tables

TABLE 1—DATUM LIST.....	97
TABLE 2—INTERFACE CONNECTOR PINS	114
TABLE 3—PORT SETUP OPTIONS.....	116
TABLE 4—NMEA 0183 SENTENCE IDENTIFIERS.....	120
TABLE 5—CONNECTION TO NORTHSTAR 800 PORT A.....	123
TABLE 6—CONNECTION TO NORTHSTAR 800 PORT B.....	123
TABLE 7—NORTHSTAR 800 SERIES OUTPUT PORT SETUP.....	123
TABLE 8—YEOMAN ELECTRONIC PLOTTER SETUP WITH 941X.....	124
TABLE 9—CONNECTING TO EXTERNAL NS BEACON RECEIVER.....	125

1

Introducing the Northstar 941X

Introduction	2
Upon First Start-up	2
Using This Manual	3
Features	4
Functions	5
Comparing GPS and Loran	5
Mounting	9
Special Functions	9
The Display Screen	10
Interfacing Capability	11

This section introduces you to the Northstar 941X navigator, outlining its various operational functions, installation configurations, and specifications.

Use this section to get a quick overview of what the 941X is all about, and how you can use it to your best advantage.

Introduction

THE NORTHSTAR 941X combines 12-channel GPS navigation with Differential GPS capability, a high-definition display, Ioran compatibility, built-in tide data up to the year 2010, and many other navigation features.

For the ultimate in GPS accuracy, the 941X may be purchased as the 941XD, featuring an internal DGPS (Differential GPS) receiver. This advanced system gives you even greater accuracy by accepting Differential GPS signal “corrections” from shore-based transmitters (called “beacons”), and using them to display position fixes as accurate as 2-5 meters. You can also connect your 941X to any external source of DGPS corrections meeting the SC-104 standard (such as the Northstar 8800 DGPS Sensor).

Upon First Start-up



When you turn your 941X on for the very first time, you may be greeted with a flashing exclamation point symbol in the lower right portion of the GPS POSITION screen, and the word ACQUIRE or SKY SEARCH in the status box at the top. The flashing exclamation point simply means that an alarm message is present and waiting for your acknowledgment.

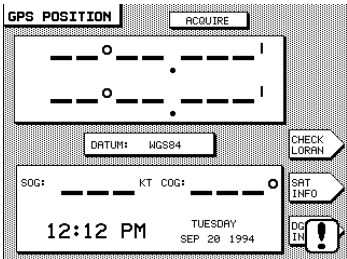

To see the message, press the STAR key once. The ALARMS AND BACKLIGHT screen will be displayed.

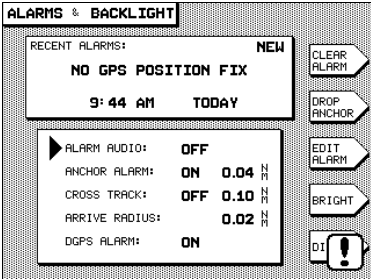

The alarm message **NO GPS POSITION FIX**, along with its time and date, are shown in the **RECENT ALARMS** box. The word **NEW** in the upper right corner of the box indicates that this is a previously unacknowledged message.

This sequence is a normal part of powering-up the 941X for the first time, as it notifies you that it is in the process of acquiring satellite information necessary for navigation. It normally takes only two to five minutes to acquire this data, after which the 941X is ready to navigate. (This alarm condition usually occurs in units shipped to customers located more than several hundred miles from the Northstar factory, and only the first time the 941X is turned on after being installed.)

Press the **CLEAR ALARM** menu key to the right of the display screen to acknowledge and clear the message. Press the **POSITION** key below the left of the screen to return to the main **GPS POSITION** screen. The 941X is now ready to navigate. (For more on alarms, see page 68. If you wish to proceed directly to navigating with the 941X, skip to page 22.)

Using This Manual

Your 941X was designed to be an easy-to-use, full-function GPS navigator, understandable in the information it displays and dependable in its performance. This Reference Manual is intended to complement that ease of use by illustrating and describing the 941X's various functions in a format helpful to quick learning and safe operation.

The sections in this manual are grouped by related functions, beginning with an overview of basic control panel layout and function commands, and gradually progressing to more advanced waypoint and route navigation operations. Sample screen images are used throughout to help illustrate what the 941X display screen looks like for the function being described.



The “helpful hand” (pictured at left) is a convenient shortcut that leads you directly to step-by-step instructions. You can also use it as a quick-reference for locating less-frequently-used operations.

Features

Upon using the 941X, you'll see that you can actually learn to operate the system's various features without constant referral to this manual. After you've read through it once, you won't have to refer to it very often again.

Since the 941X anticipates your most frequent requests for navigation information, accessing most functions requires only one or two button pushes. By minimizing the attention needed to navigate, you can now devote more time to other aspects of your trip.

GPS features

- accurate, worldwide position data in any weather, 24 hours a day
- optional internal DGPS (Differential GPS) Beacon Receiver for accuracy as good as 2-5 meters
- fast signal acquisition
- fast-reacting, accurate speed and course

navigation features

- lat/lon display
- built-in plotter shows:
 - 1) your position relative to nearby waypoints;
 - 2) your recent track line;
 - 3) your intended course line; and
 - 4) avoidance areas,

all against a latitude/longitude grid.

- tide prediction software integrated with navigation display (at any NOAA tide station; for today or any other date.)

waypoints and routes

- stores up to 1,000 waypoints and 500 routes
- displays waypoints:
 - 1) in alphabetical order
 - 2) in order of distance from your present position
 - 3) saved with the **SAVE** button
 - 4) stored as avoidance points
- plots position of:
 - 1) nearby waypoints
 - 2) routes
 - 3) avoidance areas

Functions

Five keys on the 941X instantly select the most commonly used functions, as described below:

POSITION displays position coordinates as

- 1) GPS lat/lon coordinates
- 2) loran TDs, if you have a loran receiver interfaced to the unit
- 3) or calculated "Phantom Loran™" TDs if you don't.

Speed- and Course-Over-Ground, and Time and Date are also displayed. An alternate position screen plots your position graphically, along with any nearby waypoints and your track history.

STEER shows how to steer precisely along a course line to your current waypoint. It also displays your Cross Track Error, Estimated time to waypoint, Estimated Time of Arrival, Course Over Ground, Speed Over Ground, Speed of Advance, etc.

(★) (The **STAR** key) displays alarm conditions and tide information, and accesses setup functions for customizing the operation and displays of your 941X, including screen brightness.

WAYPTS/ROUTES lets you enter or access waypoints and routes for navigation.

NAV LOG displays the progress of your current navigation plan (today's trip) and lets you modify it.

In addition to these function keys, the **SAVE/MOB** key instantly saves your position as a waypoint, and provides a Man Overboard function for returning to the saved point.

Five **MENU KEYS** on the right edge of the display are used to select between specific choices displayed on the screen.

Comparing GPS and Loran

The nation's GPS system has received much publicity, often described as providing the ultimate in navigation accuracy for all applications. Its major advantage over all other commercially-available navigation systems, including loran, is its all-weather, worldwide availability and *absolute accuracy*. (*Absolute accuracy* refers to the ability of a navigation device to determine your actual latitude and longitude coordinates on the surface of the earth, as compared to position information determined

from a chart or other reference. *Repeatable accuracy* refers to the ability to return to a position whose coordinates you have previously recorded with the same equipment.)

Developed by the United States Department of Defense (DOD) the GPS system of 21 active satellites (with 3 additional spares) literally encircles the earth with navigation information. GPS is offered in two forms: for military users and for civil users.

selective availability

With GPS available to virtually anyone around the world, the DOD wanted to avoid the possibility that its precision could be used by hostile forces as a source of accurate targeting data against U.S. interests. To guard against such actions, they introduced intentional errors into the GPS signals that only U.S. forces could bypass. Called ***Selective Availability*** (or SA), it involves a complex formula of data encryption that can be turned on or off without the end-user ever knowing for sure whether it is in effect or not. DOD's stated position is that SA will remain in effect indefinitely.

GPS and DGPS

Selective Availability effectively reduces GPS's absolute and repeatable accuracy from 30 meters (roughly 100 feet) 95% of the time, to 100 meters (330 feet) 95% of the time. This means that, with SA, you can expect to be within 300 feet of your intended position 95% of the time, and beyond that area approximately 5% of the time. At first, this was accepted by most end-users as an inevitable part of GPS, a tradeoff against its global availability. But it didn't meet the Coast Guard's requirement of 8-20 meter accuracy for navigating harbors. It was then that a system of *differential corrections* was developed by the Coast Guard that enabled them to effectively circumvent SA's built-in errors.

These differential corrections are generated by fixed "reference stations" and broadcast by marine radiobeacons over a relatively limited area—usually a maximum broadcast radius of 250 miles—to Differential-capable GPS (DGPS) receivers. The precise geographic location of the reference station is used to calculate corrections based on the GPS data received from the satellites, and the corrections are then broadcast to DGPS receivers. The receivers then convert this data into extremely precise position, heading and speed information. (Referred to as

“beacons,” the transmitters are being situated at various locations along the U.S. coastline and Great Lakes, most of which are former marine radiobeacon sites.)

With DGPS, navigators are guaranteed position accuracy on the order of *2-5 meters* 50% of the time, and to 10 meters 95% of the time (usually, much better). Lat/lon positions displayed to thousandths of minutes (roughly 6 feet) are common with DGPS. When using a radar or electronic plotter, DGPS corrections improve the steadiness of your displayed plot line dramatically.

In addition to accurate positioning information, DGPS provides critical “integrity monitoring” of the received GPS signals, enabling the user to be notified in seconds (as opposed to hours, with uncorrected GPS) that an anomaly has been detected in a transmitted satellite signal. The integrity monitor instructs the DGPS receiver not to use data from the satellite in question.

loran Loran, on the other hand, can still outperform non-differential GPS—when SA is in effect—in *repeatable accuracy*. Though susceptible to weather and characterized by a relatively limited range (when compared to GPS), it’s a dependable system familiar to thousands of boat owners.

Since the 1970’s, LORAN users have relied upon that system’s ability to repeatedly get them back to a previously-saved location with extreme accuracy. Fishermen especially appreciated this capability because each subsequent visit to a lobster trap or buoy was virtually “on the mark,” saving them valuable time and money. Loran’s *repeatable* accuracy was superior to anything else commercially-available at the time.

In very good coverage areas, loran can typically get you to within 50 feet (or roughly 14 meters) of your previously-visited target. On the other hand, at its very best, uncorrected GPS with SA enabled will get you to within *300 feet* (100 meters) of your intended destination. Obviously, uncorrected GPS—with variations of up to 300 feet in displayed position—wouldn’t be much help in getting you through a narrow channel. Since most loran chains were configured for optimum coastline navigation, it’s easy to see why loran’s *repeatable* accuracy has served harbor-masters and fishermen well for the last 25 years.

Loran, however, isn't as proficient as GPS in *absolute accuracy*, or visiting a spot for the first time. Since it transmits at a relatively low frequency (100 kiloHertz—similar to that on your AM radio), your ability to get an accurate position “fix” is directly related to: 1) your distance from the loran transmitters, and 2) the weather between you and the transmitters. It's in these two areas that GPS consistently excels when it comes to *absolute accuracy*.

Even with SA, GPS provides an *absolute* accuracy of around 300 feet nearly everywhere in the world, under virtually any conditions. With a “constellation” of satellites orbiting the earth and transmitting their position data on an extremely high frequency (1.575 GigaHertz, or 1.5 *billion* cycles per second), GPS is impervious to weather and your location on the surface of the earth. You can receive position fixes at any time, anywhere, in any weather. This far surpasses the *absolute* accuracy that is achievable from a good loran receiver in a strong signal coverage area, in favorable weather conditions: usually 600 feet.

If you are accustomed to using your Northstar loran's *repeatable* accuracy to return to within a boat length of a lobster trap or a buoy, time after time, you will not necessarily see this same performance with uncorrected GPS—you could be as much as 600 feet from your expected position. This will be especially apparent when using the 941X's plotter screen (without DGPS), where you may see your boat's plotted position appear to wander around within an area up to 600 feet in diameter (see Figure 1 below).

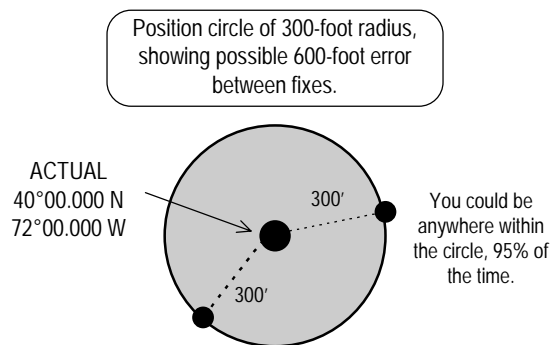

Figure 1—Max. Position Variances with Uncorrected GPS

getting more accuracy If you need a higher level of accuracy than what basic GPS provides, there are two choices available to you:

1. Use *Differential GPS* by installing a Northstar internal differential beacon receiver (or use an externally-located Northstar differential beacon receiver), or other source of differential corrections for your 941X. DGPS should provide better than 10-meter accuracy (repeatable and absolute) 95% of the time. See “Using GPS” on page 25 for more information.
2. Interface your *loran receiver* to your 941X (provided the loran has the appropriate NMEA 0183 format output capability). You will then keep the “repeatable accuracy” of your loran, and add all of the navigation features of the 941X, including the excellent worldwide “absolute accuracy” of GPS. Refer to Table 2 on page 114 for connector pin wiring guide.

Mounting

The 941X is designed to be yoke- or flush-mounted on your boat. The unit is waterproof and can be exposed directly to the weather. The GPS antenna should be mounted fairly low on the vessel to minimize the effects of pitch and roll, and where it has a clear view of the entire sky. The Beacon Receiver antenna (if installed) should be mounted fairly high, like a loran antenna. Refer to “Mounting the 941X,” on page 100, for details.

Special Functions

The following functions are unique to the 941X; you may want to read about them in detail before using them.

Ioran TDs

The 941X automatically converts GPS coordinates to loran TDs for those who have lists of fishing spots and other waypoints recorded as TDs. This feature is called Phantom Loran™. You can display your position as TDs or enter waypoints as TDs. The accuracy to be expected from this conversion is generally better than 500 to 1500 feet. You can also interface your existing loran receiver to the 941X and then display and navigate with

real-time loran TDs. These features greatly ease the transition from using loran to using GPS. See page 30 for further details on using loran TDs.

plotter functions

The 941X's plotter provides a picture of your position, and of what is around you. Nearby waypoints, avoidance areas, and a lat/lon grid may be displayed along with an image of your boat.

When you are using the plotter, the five menu keys below the display screen allow you to perform the following functions:

- 1) restart the desired track line to run directly from your position to the waypoint, "zeroing" the cross-track error display
- 2) change the options available for the plotter
- 3) center the image of the boat on the screen
- 4) zoom in to show more detail
- 5) zoom out to show more area

See page 22 for more information on using the plotter.

TideTrack™

TideTrack displays a 24-hour tide graph for any of over 3,000 NOAA tide stations covering the entire U.S. coast, including Alaska and Hawaii, as well as much of the western Canadian coastline. Tides may be shown for today or any other day you choose. See page 71 for more information on using TideTrack.

The Display Screen

The Liquid Crystal Display (LCD) and all controls are lighted for night-time use. The display is easily readable under all conditions, from full sunlight to total darkness. Anti-reflection treatment of the display and its window eliminates over 90% of the reflection and glare. Important data can be displayed using large numbers which can be seen from a distance.

To adjust the brightness, press the **STAR** key (★) and use the **BRIGHT** and **DIM** menu keys to set the desired illumination. Contrast is controlled by the **ARROW** key to the left of the screen.

cleaning the screen

Use caution when cleaning the plastic window in front of the display screen. Although it is resistant to scratches, it can be damaged if you wipe dirt off with a dry cloth. Always use a damp cloth when wiping the window. Use a small amount of window cleaner or alcohol to dissolve

any oil or grease on the screen. Whenever possible, avoid touching the window with your fingers, as natural oils from your hand will temporarily degrade the characteristics of the window and cause your fingerprints to appear as bright reflections. These will disappear when the screen is cleaned as described above.

CLEANING HINT

Pre-packaged moist towelettes (especially those containing a small amount of alcohol) are excellent for cleaning the display window. You might wish to keep a supply on hand to wipe off fingerprints and other smudges.

**Interfacing
Capability**

The 941X contains two independent output ports for driving NMEA-compatible devices, two input ports for accepting data from other NMEA devices, and an auxiliary port reserved for future use. It also features an RS-232 port for input or output of SC-104 DGPS corrections, and way-point/route or software program loading from a PC. The 941X can be interfaced to a wide variety of devices, including autopilots, plotters, radars, etc. Refer to “Interfacing the 941X,” beginning on page 112, for more information.

2

Using the Controls

POWER Key	14
CONTRAST Key	14
SAVE/MOB Key	15
Function Keys	16
Menu Keys	17
Cursor Keys	17
Keypad	17
Special Display Windows	18

THIS SECTION describes each of the Northstar 941X's controls. Use this section for learning what each control does and for an overview of using its various functions.

THE MAJOR FUNCTIONS of each of the 941X's controls are described in this section.

POWER Key



Press the **POWER** switch briefly to turn on the 941X. The unit displays a special startup screen that includes an owner-identification message which you may customize to aid in theft-prevention. Next, the 941X displays the results of the internal self-tests that are automatically run each time the unit is turned on. Finally, navigation data is displayed.

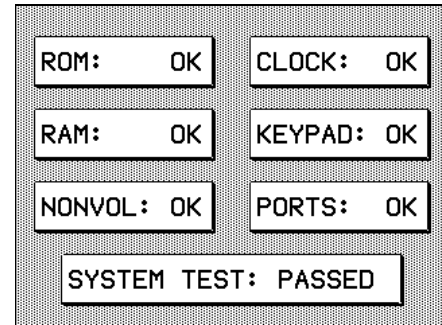
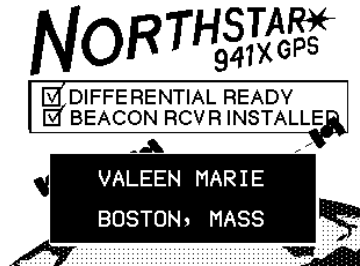

If any of the six major components of the 941X fails the self-test, the notification **SYSTEM TEST: FAILED** will remain on the screen until you acknowledge it with the press of any function key (located below the display screen). Return the 941X to the factory for service.

To turn the 941X off, press the **POWER** switch and hold it in for at least one full second until the unit turns off.

CONTRAST Key



Liquid Crystal Display (LCD) screens require a contrast adjustment to compensate for different viewing angles, temperature conditions, etc. The 941X's contrast control allows you to adjust its display screen to give the best picture for your current conditions. Pressing the upper contrast arrow darkens the screen, and pressing the lower arrow lightens it. Adjust the screen for the best contrast as seen from your normal operating location.

SAVE/MOB Key



saving a waypoint

The SAVE/MOB key is used to save your current position as a waypoint. It does this in either of two ways, depending on whether you press the key briefly, or press and hold it.

Press the SAVE/MOB button briefly to simply store your position. This new waypoint will automatically be given a name, such as –S002–, where the letter S indicates a saved waypoint, and the 3-digit number increases by one every time you save a waypoint.

The waypoint’s 3-digit number will “wrap around,” or revert, to –S001– when the 941X has reached the limit you set using the MAX SAVED WPT # function under DISPLAY OPTIONS (see page 80).

Man Overboard feature

Press and hold the SAVE/MOB button for three seconds to enter “Man Overboard” (MOB) mode. The 941X saves your position and displays it in the plotter screen as an “X.” The plotter screen is locked on the display, showing your position and the MOB location. The MOB location immediately becomes your current waypoint, with new bearing and distance information displayed on the right-hand side of the screen.

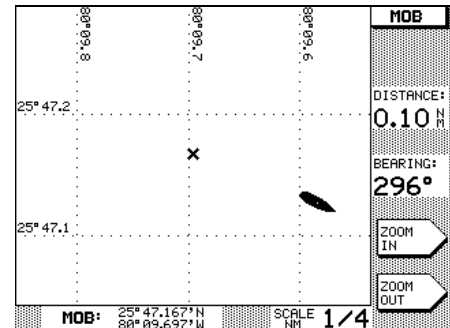
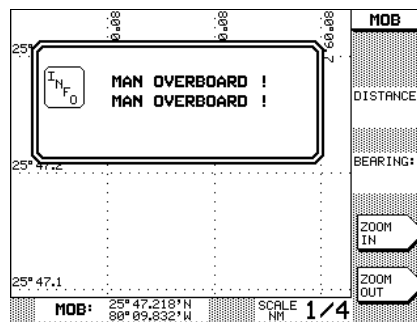

INVOKING MOB WHILE USING AN AUTOPILOT

Some autopilots will attempt to steer your boat according to any bearing changes output by the 941X, regardless of the severity of the change. Others automatically disengage when a severe or abrupt turn is required. Please refer to your autopilot manual for information regarding this procedure.

To leave MOB mode and return to normal navigation, press **SAVE/MOB** for at least three seconds.

Function Keys

The five function keys located below the display screen control what the 941X is doing. Any function key may be pressed at any time to display the information you need to see.

POSITION key



"Where am I?"

The **POSITION** key displays your position coordinates, or displays a plotter screen to show your position graphically, relative to nearby waypoints and your track history. Course-Over-Ground and Speed-Over-Ground are displayed at the bottom of the screens.

Position coordinates may be shown as any of the following:

- 1) Lat/lon from GPS
- 2) Lat/lon from an external loran receiver
- 3) loran TDs from an external loran receiver
- 4) Phantom Loran TDs which the 941X calculates from its GPS coordinates

STEER key



*"How do I
get to my
waypoint?"*

The **STEER** key shows how to steer to a waypoint you have designated. A picture of your position relative to the course line is displayed, along with all the numeric information you need to steer directly to your waypoint. Two versions of the steer display are available. Press **STEER** once to see the version you were last using. Press it again to see the other version.

STAR key



The **STAR** key (★) has several functions. The first press displays any alarms and messages the 941X has waiting for you. The second press displays information about tides for your choice of over 3000 NOAA tide stations. The third press displays the time of day, and the time of today's sunrise and sunset. The fourth press displays a menu of setup and customization functions used whenever you wish to change the way the 941X works for you.

WAYPTS and ROUTES key

*"Where do I
want to go?"*



The **WAYPTS/ROUTES** key allows you to enter waypoints and routes, access a library of waypoints and routes that you have entered previously, or specify where you want to navigate to.

See Sections 4 and 5 for waypoint and route information.

NAV LOG key The NAV LOG key displays the waypoints you have passed, and allows you to change those ahead of you. See “What NAV LOG Does,” on page 64, for more information.



*“How am I
doing?”*

Menu Keys

The five round MENU keys on the right side of the display screen are used for different purposes depending on what function is currently being used or displayed. The function of each key is labeled on the screen, and pressing the key performs the displayed function.

Cursor Keys

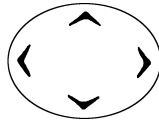

A large cursor pad in the upper right corner of the 941X allows you to move the flashing cursor on the display screen to the data you want to display or change. For example, when entering data (such as a waypoint’s name or coordinates) press the down arrow to move the cursor downwards to a particular field of data and press the right arrow key to move the cursor to a particular character in that field.

Keypad

The 12-button alphanumeric keypad is used for entering numbers, letters or special characters for waypoint coordinates, names, etc.

entering numbers

When the 941X is expecting you to enter numbers only, such as for waypoint coordinates, the keypad keys enter one digit, 0-9, with each key-press. The flashing cursor moves automatically to the next digit position.

For entries such as latitude and longitude—where the digits must be entered into specific character positions—the cursor starts on the left side of the field and characters are entered left to right into their correct positions.

For other numeric entries such as distances—where a number of variable length may be entered—the digits are entered calculator-style from the

right side of the field. If you make a mistake, you can press **CLEAR** to clear the entire number and re-enter it, or you can press the left-arrow cursor key to reenter particular digits, one at a time.

entering letters

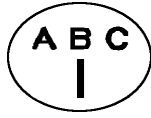

When the 941X is expecting letters to be entered, such as waypoint names and descriptions, the operation is slightly different. Each key is labeled with three letters (or other special characters) and a digit.

For example, the upper left key is labeled with the letters **A**, **B**, **C** and the digit **1**. Pressing the key one time displays the letter **A**. Press the key again to display the second letter, **B**. Pressing a third and fourth time displays the letter **C** and the digit **1**, respectively. A fifth press brings you back to the letter **A** again.



To enter a character, first find the key containing the character, and press that key one to four times to display the desired character. Finally, move the cursor to the next character position by pressing the right arrow symbol on the cursor key.

CLEAR and **ENTER** keys



The keypad also contains **CLEAR** and **ENTER** keys for erasing or entering data that has been typed on the keypad. Pressing the **ENTER** key is always the last step when entering or changing data, or acknowledging an action. The **CLEAR** key removes any data you typed before you press **ENTER**, and sets the field to all blanks or restores it to its value before you changed it.

Special Display Windows

Occasionally, the 941X needs to inform you of something or ask permission to do something. When this happens, a special information or question window appears on the display. The window contains an exclamation point ("!"), an "INFO" label, or a large question mark ("?"), and a message for you to read.

alarm messages



Alarm messages contain information you should read right away. Alarms are communicated by the flashing exclamation symbol in the bottom-right portion of the display.

Press the **STAR** key once to show the alarm condition on the **ALARMS & BACKLIGHT** screen. Press the **CLEAR ALARM** menu key to acknowledge and clear the message.

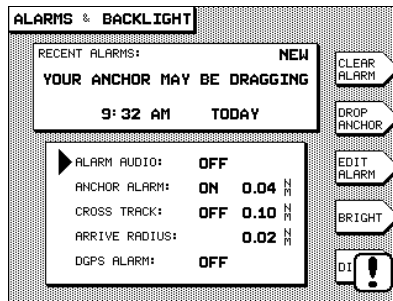

information windows *Information windows* are displayed while you are entering data or using control functions. They give you extra details pertaining to what is about to happen, or let you acknowledge a command. Information windows always appear with the word “INFO” in a small box.

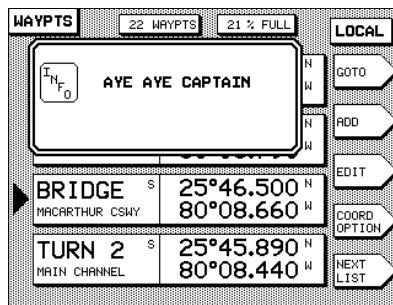

question windows *Question windows* appear when the 941X needs to know more about what you want to do. A question mark will always appear in this type of window.



You must respond to any question window by pressing ENTER to answer “YES,” or CLEAR to answer “NO.” All other keys, including the function keys, are inactive when a question window is displayed.

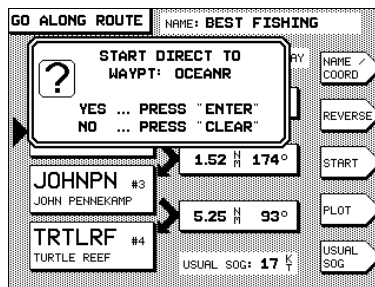

3

Basic Navigation

Displaying Position, Heading & Speed	22
Position Plotter	22
Using GPS	25
Using Loran	30
Using Phantom Loran	32

THIS SECTION describes the most basic—yet important—navigation function available in the Northstar 941X: determining your position.

Position coordinates may be determined from the GPS satellite system, or you may display loran coordinates if you have connected a loran receiver.

For those who no longer have a loran receiver, but wish to view their position in loran TDs, the 941X can convert GPS coordinates into Phantom Loran coordinates.

Displaying Position, Heading & Speed

TO DISPLAY the coordinates of your current position, simply press the button marked **POSITION**. A screen is displayed showing your position coordinates at the top, and your Course-Over-Ground (COG) and Speed-Over-Ground (SOG) at the bottom. (If you see the **PLOT** screen displayed instead of your position coordinates, just press the **POSITION** button again).

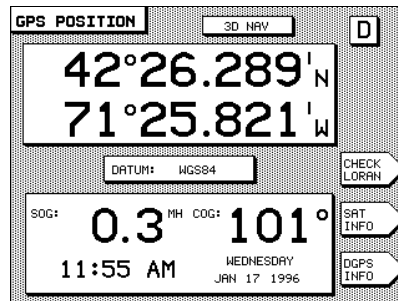

GPS position coordinates are displayed as latitude and longitude. You may choose to display loran coordinates instead, as described below. (Loran coordinates may be obtained from a loran receiver connected to the 941X, or may be calculated by the 941X from the GPS position coordinates.)

Position Plotter

The position plotter screen is a “north-up” display, and provides an overall view of the surrounding area and all nearby waypoints. Press the **POSITION** key to show your position plotted relative to your current route (if any), your track history, and any nearby waypoints and avoidance points.

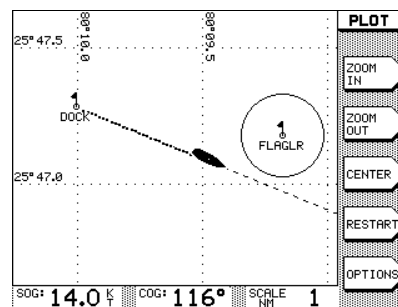

A maximum of 30 local waypoints can be displayed on the plotter screen at one time.

The image of your boat displayed on the screen points in the direction of your Course-Over-Ground. Remember, this direction may be different from your heading. The boat image shows your actual direction of travel over the bottom, not the direction your boat is headed. If your boat is not moving, the Course-Over-Ground cannot be determined by the 941X, and the direction of the boat on the screen has no meaning.

Avoidance areas (waypoints for which a warning radius has been specified) are shown as a circle surrounding the waypoint.

Your present Speed-Over-Ground (SOG) and Course-Over-Ground (COG) are displayed at the bottom of the screen, along with the chart scale. The chart scale is the distance from the top edge to the bottom edge of the plot.

NOTE:

The plotter screen can be used to steer by when the objective is simply to get to the waypoint without needing to remain precisely on the designated course line.

zooming Press the **ZOOM IN** menu key to zoom in for a closer look at the area in the center of the screen. Press the **ZOOM OUT** menu key to zoom out to see more area. Each press of the **IN** or **OUT** key approximately halves or doubles the chart scale, respectively.

The maximum zoom-in screen displays an area that is approximately $\frac{1}{4}$ -mile from the top edge to the bottom, while maximum zoom-out shows you an area that is up to 128 miles, top to bottom.

centering the plot Press the **CENTER** menu key at any time to move the plotted area so that your boat is at the center of the screen.

course restart If you wander off your intended course line, and you want to navigate directly to the waypoint rather than returning to the original course line, press the **RESTART** menu key, then **ENTER**. A new course line will be computed and displayed, running from your present position to the next waypoint.

plotter options To set up the parameters for the display of data on the plotter screen, press the **OPTIONS** menu key. The following screen is displayed:

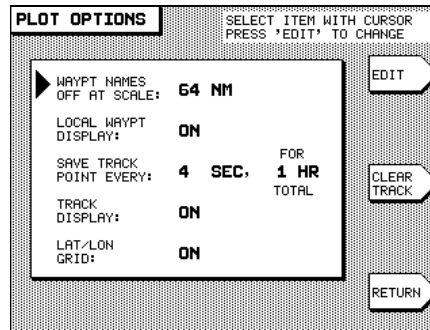

The plotter control menu allows you to change the following items:

- The plotter scale at and above which waypoint names will not be displayed on the plotter screen
- Whether local waypoints are displayed on the screen
- How often your position is recorded on the screen
- Whether your track history is displayed on the screen
- Whether a lat/lon grid is displayed on the screen



To change any one of these, use the up and down cursor keys to move the arrow to the item you want to change, and press the **EDIT** menu key. This will cause a large cursor to flash on the field, indicating you should use the up and down cursor keys to select the option you want. Press **ENTER** when done, or **CLEAR** to restore the field to its original value.

The 941X can store up to 900 points in its track, so the maximum length of the track depends on how often points are stored.

You may choose to store track points every second, with a maximum length of 15 minutes, or every two minutes for a maximum length of 30 hours, or a number of settings in between.

You may also choose to freeze the track, so that no more points will be stored and the track will remain unchanged.

Pressing the **CLEAR TRACK** menu key clears the track history displayed on the screen.

Press the **RETURN** menu key to go back to the plotter screen.

Using GPS

Your 941X contains an internal GPS receiver which is used as the primary source of position data.

GPS data is displayed directly on the **GPS POSITION** screen.

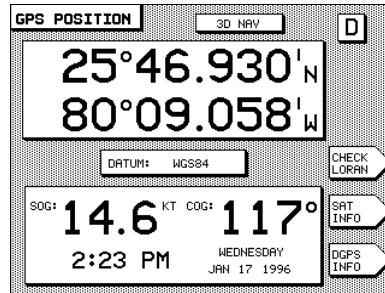

lat/lon coordinates The GPS position screen displays your latitude and longitude in large digits near the top of the screen. If GPS data is not available, dashes are displayed in place of the numbers.

You can display lat/lon as either degrees, minutes and seconds, or as degrees, minutes and thousandths of minutes. See "Display Options," on page 78, to select one or the other.

time of day The time of day and today's day and date (obtained from the GPS satellites) are displayed at the bottom of the screen.

speed and course Near the bottom of the screen, your Speed-Over-Ground and Course-Over-Ground are displayed in large digits.

NOTE

The 941X's speed and course readings are the result of instantaneous measurements derived from satellite signals. GPS speed is updated every second. However, you may average these readings by changing the "GPS speed averaging" value (see page 87).

datum In the center of the screen, the name of the datum currently in use is displayed. The datum describes the reference of the chart you are currently using (the reference datum used is indicated on each chart). Applying the datum corrects for any position differences between your chart and the GPS coordinate system. See "Geodetic Datum," on page 94, for more information on selecting the datum for your area.

NOTE

When using differential GPS (DGPS) as your navigation source, your position, as displayed by the 941X, may actually exceed the accuracy of some charts.

status summary At the top center of the position screen is a brief status summary of the GPS receiver. The following table shows the various status messages the 941X may display, along with their meanings.

Message	Meaning
ACQUIRE	trying to acquire satellites
SKY SEARCH	searching for satellites with no previous information
TRACKING	satellites have been acquired; almost ready to navigate
2D NAV	navigating with 3 satellites in 2-D mode
3D NAV	navigating with 4 or more satellites in 3-D mode
POOR FIX	tracking satellites with poor geometry/accuracy
COMM FAIL	communication link to GPS sensor has failed—unit needs repair

Using DGPS

In the upper right corner of the GPS POSITION screen is an indicator that shows whether Differential GPS (DGPS) corrections are in use. If your installation includes an optional Northstar internal differential GPS receiver, or other external source of differential corrections, navigational accuracy will be significantly improved when this indicator is present.

For further information on operating in DGPS mode, refer to “Internal Differential Beacon Receiver,” on page 74.

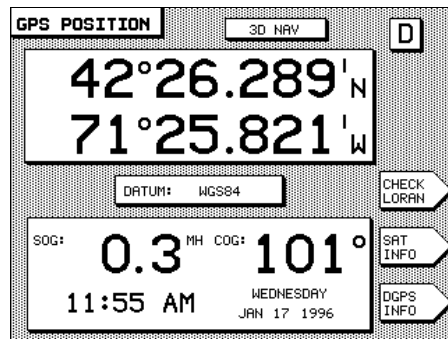

With DGPS active, you will often see position measurements accurate to about 2-5 meters, speed measurements accurate to about 0.1 knot, and Course-Over-Ground measurements accurate to about 0.5 degree. DGPS corrections remove the errors caused by Selective Availability (SA) and the atmosphere, and provide an accuracy exceeding that obtained by military users of the GPS system. If the DGPS indicator is displayed, you have this higher level of accuracy. For the **POSITION** and **STEERING** screens, the DGPS indicator is a large letter “D.” For the plotter screen, the DGPS indicator is the symbol **DGPS**.

satellite status

To display more information about signals received from the GPS satellites, press the **SATS** menu key on the GPS position screen. A screen is displayed showing the received Signal-to-Noise Ratio for each satellite, and a map indicating where the satellites are currently located in the sky (the 12-channel **GPS SATS** screen is shown on the next page). Satellites are identified by their *PRN* number, a two-digit number assigned by the U.S. government.

The center of the satellite map represents the center of the sky, and the outer (or last) ring is the horizon. The view is looking down from above, with East to your right and West to your left.

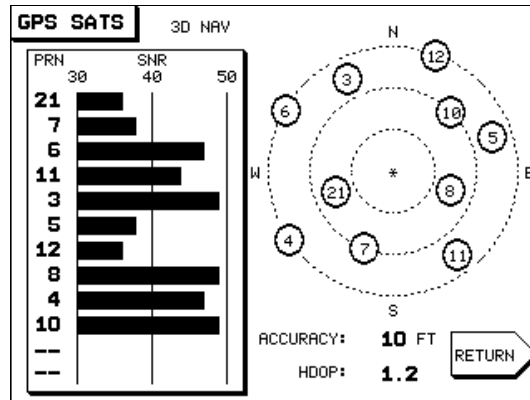

NOTE
 On five-channel 941Xs, the last bar at the bottom of the screen will sometimes "jump" around once per second as the 941X receiver sequences among other satellites.

The following GPS data is also displayed:

ACCURACY: The estimated accuracy of the GPS system to be expected at the current time. Your position readings should be more accurate than this estimate 95% of the time.

HDOP: This is a technical measure of the "quality" of your fix. HDOP (Horizontal Dilution of Precision) can range from an ideal value of 1, up to 10 or more. Any value less than 2 indicates excellent performance. HDOP is calculated from the satellites' current positions, and is not based on actual received signals. You will usually see an HDOP value displayed immediately after the unit is turned on, and before it is ready to navigate.

Press the RETURN menu key to return to the previous screen.

DGPS status To display more information about DGPS corrections that are being received, press the DGPS menu key on the GPS position screen. A screen is displayed showing the DGPS beacon transmitter currently in use. The upper part of the screen shows the beacon's name and position, the frequency of the transmitter, and the baud rate of the transmitted data.

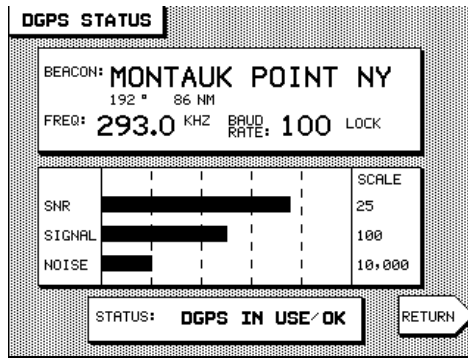

The lower part of the screen shows three bar graphs:

1. **SNR** The Signal to Noise Ratio (SNR) is a good overall measure of overall signal quality, and should be as high as possible. Values of 15 and higher are preferred, while anything below 10 could indicate poor reception.
2. **SIGNAL** The actual strength of the received signal—should be as high as possible. Varies with distance from beacon transmitter.
3. **NOISE** Noise level measures the “static” caused by lightning and other atmospheric effects, and should be low for best results. See “DGPS antenna mounting” on page 112, for further details.

NOISE LEVEL VALUE	MEANING
200 or less	excellent
1,000 – 3,000	typical at night
5,000 – 10,000	thunderstorm

At the bottom of the screen a summary of DGPS operation is displayed. You may see one of the following messages:

MESSAGE	MEANING
OLD CORRECTIONS	No DGPS corrections have been received within the DGPS DATA TIMEOUT limit set in RECEIVER OPTIONS (default is 1 minute), and the navigator has returned to non-differential operation. See "GPS data timeout" on page 89 for details.
NOT INSTALLED	A beacon receiver is not installed.
UNHEALTHY BEACON	The beacon transmitter reports it has problems.
UNHEALTHY SATS	Data received from satellites cannot be relied upon.
ACQUIRING SATS	1) The GPS receiver cannot operate in DGPS mode until it has received ephemeris data from the satellites; or 2) the receiver does not have a GPS fix yet.
DGPS IN USE/ OK	DGPS corrections are being received and used.

DGPS signal quality information for the 941X is available from the optional internal beacon receiver, or from an optional external Northstar beacon receiver. Other brands of beacon receivers may supply DGPS corrections but omit the additional signal information shown on the 941X's screen.

Press the RETURN menu key to return to the previous screen.

Using Loran

If you have a loran receiver connected to your 941X, you can navigate using loran coordinates as well as GPS. Just select loran as the source of navigation data, as described below, and you're on your way.

selecting loran

To display loran TD coordinates from a loran receiver interfaced to the 941X, first select loran as the navigation source, as described below.



1. Press the STAR key until the USER CUSTOMIZATION screen is displayed.
2. Press the NAVIGATION OPTIONS menu key. The NAVIGATION SOURCE line will be designated by the cursor arrow.
3. Press the EDIT menu key. The cursor will begin flashing.

- Press the up and down cursor arrow keys to display **EXTERNAL LRN** as the position source. If you change your mind, press **CLEAR** to restore the original setting; otherwise, press **ENTER**, then the **RETURN** menu key.

loran TDs The loran display screen looks like this:

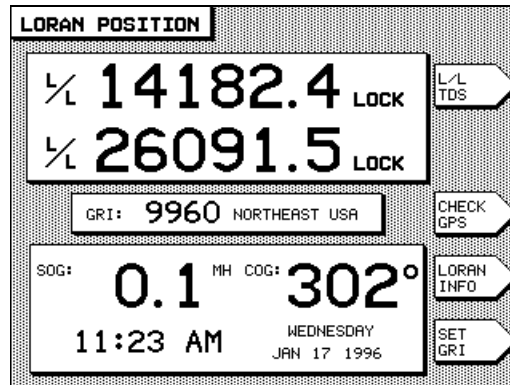

Press the L/L TDS menu key several times to select either the particular pair of TDs you wish to use, or the loran-derived latitude/longitude.

NOTE

In order to display loran position coordinates on the 941X from an externally-connected loran receiver, the loran must support the standard NMEA 0183 "RMA" output data sentence structure. Without this output capability, the 941X will not receive position data from the loran. For best results, connect a Northstar 800 series loran to the 941X, using the 800's "PRINTER 3" output format. See "connecting to a Northstar 800 series loran" on page 123.

loran GRI The four-digit loran Group Repetition Interval (GRI) is changed using the **SET GRI** menu key on the **LORAN POSITION** screen. You must set this to correctly match the GRI being used by your loran receiver for the 941X to accurately convert the loran's TDs to latitude/longitude position fixes.

loran warnings Loran warning indicators obtained from any Northstar 800 series loran receiver are displayed to the right of each TD. These are:

INDICATOR	MEANING
SNR	Signal-to-Noise Ratio is low—use caution
BLNK	Coast Guard is transmitting a blink signal indicating a probable transmitter problem
CYC	the receiver has detected a possible cycle slip
LOCK	the receiver has locked onto the loran track point. This is not a warning indicator but an indication of normal performance.

Note: These indicators are available only from Northstar 800 lorans.

The “L/L” indicator to the left of a TD designates it as one of the two TDs that the loran receiver has chosen to use to calculate latitude and longitude.

The “F/L” indicator to the left of a TD indicates that it has been forced by the user to be used to calculate lat/lon.

loran info

To check the quality of signals being received by your loran, press the **LORAN INFO** menu key from the **LORAN POSITION** screen. The Signal-to-Noise Ratio for each loran transmitting station is displayed graphically. Press **RETURN** to go back to the loran position screen.

checking GPS status

To temporarily display GPS coordinates and signal status, press the **CHECK GPS** menu key. The unit continues to navigate using loran, and will display loran data the next time you return to the position screen.

returning to GPS navigation

To return to GPS signals for navigation, repeat the steps shown above for selecting loran, except specify GPS instead of loran.

Using Phantom Loran

The 941X’s Phantom Loran feature is designed for those users who have compiled lists of fishing spots or other locations as loran TDs, and are now using the 941X as a GPS-only navigator. The 941X will mathematically convert GPS lat/lon coordinates to loran TDs, enabling you to display your position as TDs.

Phantom Loran operation

The 941X may be used to simulate full operation of a loran receiver. Position coordinates may be displayed as TDs, and all navigation functions may be used as if the unit were actually receiving loran signals. Remem

ber, however, that these calculated TDs will not match exactly the positions of previously recorded TD coordinates obtained directly from actual loran signals. In most areas, errors should not exceed 0.2 microsecond. However, larger errors are possible in areas for which the 941X does not contain accurate, factory-programmed ASF correction points.

selecting Phantom Loran





To display Phantom Loran TDs as position coordinates, first select Phantom Loran as the position source, as described below.

1. Press the **STAR** key until the **USER CUSTOMIZATION** screen is displayed.
2. Press the **NAVIGATION OPTIONS** menu key. **THE NAVIGATION SOURCE** line will be designated.
3. Press the **EDIT** menu key.
4. Press the up or down arrow keys to display **PHANTOM LRN** as the position source.
5. Press **ENTER**, then the **RETURN** menu key.
6. To view your position in Phantom Loran coordinates, press **POSITION**.

Phantom Loran TDs

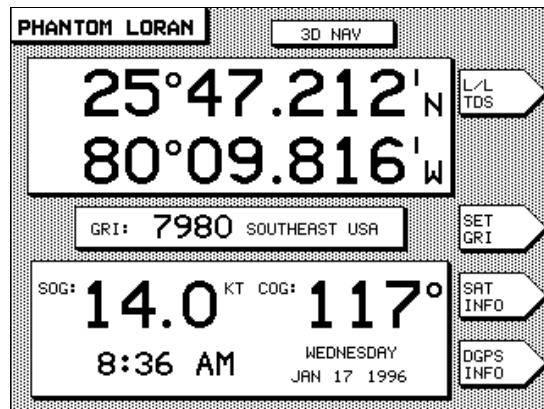
The Phantom Loran display screen looks like this:



- choosing L/L or TDs** Press the **L/L TDS** menu key several times to select the particular pair of TDs you wish to use or to display GPS latitude/longitude.
- Phantom Loran GRI** Press the **SET GRI** menu key to change the GRI to be used in calculating the displayed TDs. Press the up and down cursor keys to display the available GRIs one at a time. When the GRI is correct, press **ENTER**.
- checking GPS status** Press the **SAT INFO** menu key to check on the received GPS satellite status, as described on page 27.
- checking DGPS status** Press the **DGPS INFO** menu button to display the current status of the beacon receiver, including SNR, SIGNAL and NOISE values (as previously described on page 29). Press **RETURN** when you wish to go back to the **PHANTOM LORAN** position screen.
- DGPS corrections** The large letter  displayed in the upper right corner of the display indicates differential GPS corrections are being received and used to improve the accuracy of the received data.
- returning to GPS navigation** To return to GPS signals for navigation, repeat the steps shown above for selecting loran, except specify **GPS** instead of Phantom Loran.
- See “Navigating to Waypoints,” beginning on page 55, to learn how to navigate to loran, Phantom loran, or GPS coordinates.

4

Creating Waypoints and Routes

Entering Data	36
Creating Waypoints	37
Avoidance Areas	39
Waypoint Lists	41
Coordinate Options	42
Updating Waypoint Coordinates	42
Editing Waypoints	43
Transferring Waypoints to a PC	44
Creating Routes	44
Saving a Route	47
Changing a Route	50

In this section, we'll learn how to create waypoints, use them to form routes, and change them as necessary.

Entering Data

Before we move on to the sections describing how to enter waypoints and routes into the 941X's memory, let's take a break and review the methods for entering data into the unit.

Some screens, such as coordinate entry screens, allow entry of numbers only. Others, such as waypoint names, allow entry of letters, digits and punctuation characters.



A typical entry screen will have several items of data displayed. First, choose the item you wish to change by pressing the up or down cursor arrow key to move the flashing cursor to that item.

The flashing cursor indicates which character position will be written into. Use the left and right cursor arrows to move the flashing cursor to the next character you want to enter.

Use the up and down arrows to move to the next line you want to enter.

When the entire screen is correct, press the **ENTER** key. The 941X will accept the full screen of data and store it in memory.

entering numbers

To enter numbers, simply press the digits of the keypad. The flashing cursor automatically moves to the next character.

You can use the arrow keys to "back up" and correct any mistakes you might have made.

entering letters

Many items, such as waypoint names, accept letters as well as numbers. Each key of the keypad is labeled with up to four characters. Find the key with the desired character, and press that key one or more times to display the character. When the character has been selected, use the right arrow cursor key to move the cursor to the next character position. Press **ENTER** when all the characters are correct.

Here are some of the things you can do with waypoints using your 941X:

1. Navigate to a point in one step (a "quick start" waypoint)
2. Enter waypoints into the 941X's memory for later use
3. Navigate to these waypoints

4. String these waypoints together to form routes
5. Follow these routes
6. Edit or erase waypoints or routes
7. Plot waypoints or routes
8. Transfer waypoints and routes from the 941X to a personal computer, and back again.

Creating Waypoints

To enter waypoints, press the WAYPTS/ROUTES key. Press the WAYPT LIST menu key and then the ADD menu key. A screen similar to the following is displayed:

To store a waypoint permanently in the 941X's memory, first assign it a name. The name can be from 1 to 6 characters long, and it must differ by at least one character from any other waypoint name in the unit's memory.

Enter the desired waypoint name. If you wish, you may also enter up to 16 characters of descriptive information for the waypoint on the line below the name (the description is optional).

If the name you chose is already in use in the unit's memory, a message is displayed, indicating you cannot use that name. You can either erase the old waypoint, if it is no longer needed, or choose a different name for the new waypoint. The name of the new waypoint need only be different from the existing waypoint by one character in order to be accepted as a valid name.

waypoint coordinates

Waypoint coordinates can be entered as lat/lon coordinates, loran TDs, or as distance and bearing from your present location or from any waypoint in the 941X's memory.



To change the coordinate type from what is currently displayed, press the **COORD TYPE** menu key until you see the option you want.

Enter the waypoint coordinates as previously described on page 36. If you make a mistake, press **CLR** to erase any characters from the line and start over; otherwise, press **ENTER** when the screen is correct.

If you are entering coordinates as distance and bearing, the 941X normally asks for these coordinates relative to your current position, known as “-HERE-.”

The screenshot shows a screen titled "NEW WAYPT" with the following fields and controls:

- NAME: SAILF
- DESC: BEST SAILFISH
- FROM: -HERE-
- BEARING: 122°
- DISTANCE: --57.50 N
- WARN RADIUS: -. N
- Navigation buttons: COORD TYPE, FROM, CANCEL

To select an entirely different location from which distance and bearing are to be measured, such as an existing waypoint, press the **FROM** menu key. A waypoint list is displayed. You can press the **NEXT LIST** or **COORD OPTION** menu keys to help select the waypoint.

Use the up and down cursor arrow keys to point to the desired waypoint. Press the **ENTER** key to designate this waypoint and return to the previous screen. If you wish instead to use your present position as the reference point, press the **FROM 'HERE'** menu key on the **'FROM' POSITION** screen.

'FROM' POSITION		PRESS 'ENTER' TO SELECT WAYPT	ALPHA
WRECK1 SCHOONER	S	25°46.438' N 79°32.642' W	CANCEL
WRECK2 SUBMARINE	S	26°03.340' N 79°23.557' W	FROM 'HERE'
WRECK3	S	25°20.437' N 80°12.050' W	COORD OPTION
-S001- 10:37:36 -TODAY-	S	25°46.950' N 80°09.114' W	NEXT LIST

avoidance area If this new waypoint is to be used as the center of an *avoidance area*, enter the warning radius at the bottom of the screen in the **WARN RADIUS** box. If no radius is entered, the point will be treated as a regular waypoint, and not as an avoidance area.

Avoidance Areas

You may designate new or existing waypoints as avoidance areas. Avoidance areas are depicted on the **PLOT** screen as waypoints with circles around them. In addition, an alarm will be given both as an audio beep and a flashing exclamation point on the screen, if you should enter and avoidance area.

The 941X will display each avoidance area as a circle the size of the warning radius you entered. For new waypoints, enter a distance in the **WARN RADIUS** box at the bottom of the **NEW WAYPT** screen. For existing waypoints, use the **EDIT WAYPOINT** function to access the waypoint coordinate screen, then enter the warning radius. Be sure to include a little extra distance around the hazard so that you will have time to respond by turning or stopping after you hear the alarm.

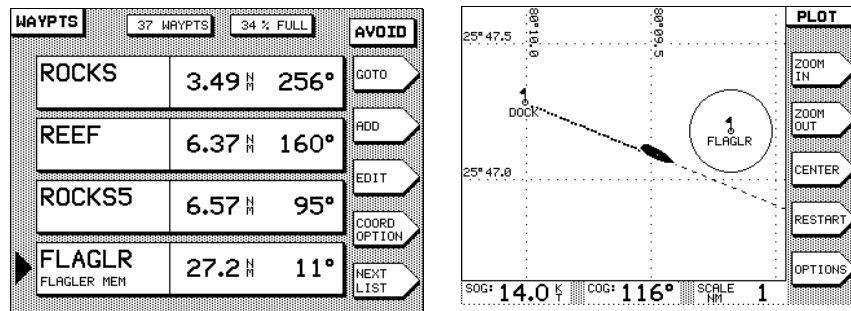

As a precaution, once you have designated a waypoint as an avoidance area, the 941X does not allow you to navigate to it.

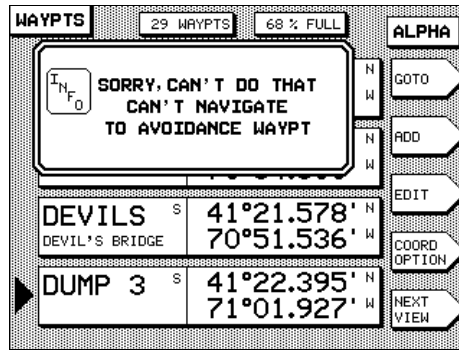

avoidance area alarm

Once you have designated a waypoint as an avoidance area, the 941X will alert you upon penetration of that area.



To set the audible avoidance area alert feature:

1. Press the **STAR** key once to display the **ALARMS & BACKLIGHT** screen.
2. Be sure that the cursor arrow is in front of the **ALARM AUDIO** option.
3. Press the **EDIT ALARM** menu key.
4. Use the up/down cursor keys to toggle the setting ON or OFF.
5. Press **ENTER** to make your selection, or **CLEAR** to leave it unchanged.

(NOTE: If you do not want to be notified of any other navigational alarms, set the **ANCHOR DRAG**, **CROSS TRACK**, **ARRIVE RADIUS**, and **DGPS** alarms to OFF. The audible alert will now only beep when you enter an avoidance area.)

CAUTION:

The 941X's avoidance alarm is intended only as an extra added safety feature to help make you aware of possible hazards. It does not replace local knowledge, proper use of charts, the person on watch, or any other aspects of good seamanship that are required for safe navigation.

Waypoint Lists

Waypoints contained in your 941X can be displayed in any of four ways. Press the **WAYPTS/ROUTES** function key, then the **WAYPT LIST** menu key to display waypoint lists. Use the **NEXT LIST** menu key to select the list that is best for your current situation. Each press of the **NEXT LIST** menu key displays a waypoint list in the following order: **ALPHA**, **SAVED**, **AVOID** and **LOCAL**, then starting again at **ALPHA**.

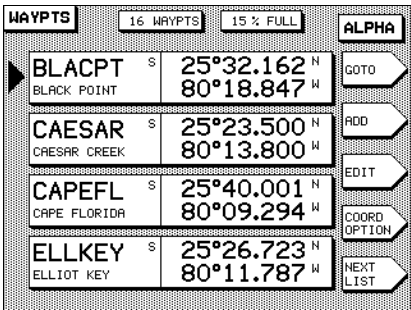

ALPHA list: all waypoints in alphabetical order

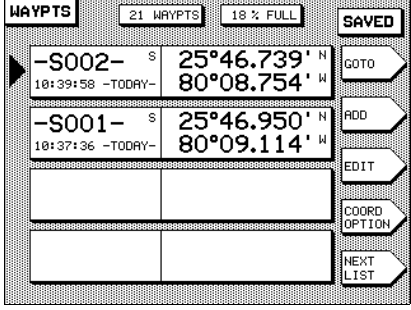

SAVED list: all waypoints created via **SAVE/MOB** key, with most recent first.

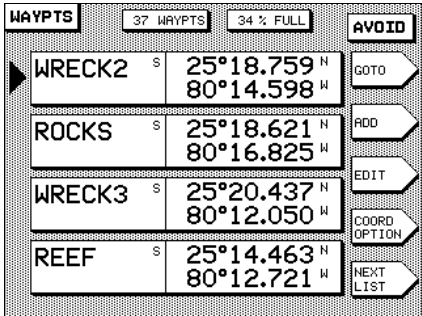

AVOID list: Avoidance waypoints within 100 nm, nearest first

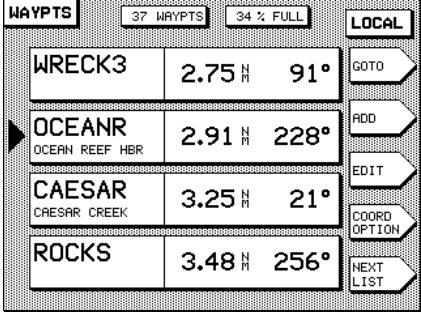

LOCAL list: 30 closest waypoints within 100 nm, nearest first

alpha list Waypoints listed under the **ALPHA** screen in the 941X's memory are displayed in alphabetical order. Waypoints with a digit as the first character appear near the beginning of the list. "Saved" waypoints appear near the end.

saved list All saved waypoints (stored by pressing the **SAVE/MOB** button, and having a name such as –S001–) are listed in order of the time at which they were saved, with the most recent first.

avoid list Up to 30 avoidance points within 100 nautical miles are listed in order of their distance from your position.

local list In the **LOCAL** list, up to 30 of the closest waypoints within 100 nautical miles are listed in order of distance from your position. This list is particularly useful when you wish to deal with only the waypoints in your area. Even though you may have hundreds of waypoints stored, the local waypoints are very often the only ones you are interested in. You may find yourself using this list most of the time.

Coordinate Options

Whenever a waypoint list is displayed, you may display the waypoint's coordinates on the right side of the screen in any of the following ways, by pressing the **COORD OPTION** menu key:

1. latitude/longitude coordinates
2. coordinates originally used to save the waypoint (TDs, lat/lon)
3. distance and bearing from your position (this is often the most useful way, since it may be easier to visualize “3 miles north” than the digits of lat/lon coordinates).

The letter “S” to the right of the waypoint name indicates that the displayed coordinates were the ones used to store the waypoint (TDs vs. lat/lon).

Updating Waypoint Coordinates

Often a waypoint is taken from a chart by measuring the approximate coordinates with whatever accuracy is allowed by the chart. When you sail to the waypoint, you may find its position is slightly different than expected. The 941X has a special feature that allows you to easily recalibrate the waypoint by setting its coordinates to your precise position. You can also use this feature to convert approximate loran TD coordinates to precise GPS coordinates.



To update a waypoint's coordinates, first sail to the spot where the waypoint will be located. Press **WAYPTS/ROUTES**, then the **WAYPT LIST** menu key, to display a list of waypoints on the screen. Press the **NEXT LIST** menu key, if necessary, to show the local waypoints (in order of distance from your position). Your waypoint should be at or near the top of this list. Use the up and down arrow keys to point to the desired waypoint. Press the **EDIT** menu key, and then the **UPDATE COORD** menu key, and finally the **ENTER** key.

The new coordinates are recorded at the instant you press the **UPDATE COORD** menu key.

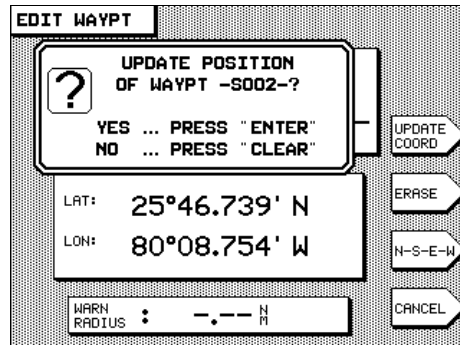

Editing Waypoints



To change any information about a waypoint you have already stored (except the type of coordinates used to save it), use the **EDIT WAYPOINT** function.

Press the **WAYPTS/ROUTES** key, then the **WAYPT LIST** menu key to display a list of waypoints. Use the up and down arrow keys to point to the desired waypoint. Press the **EDIT** menu key. You may change the name, description, coordinates and/or warning radius of the waypoint.

Set the warning radius to zero if you want to remove the avoidance feature from this waypoint. In addition, you can press the **UPDATE COORD** menu key to correct the waypoint's coordinates, as described in the previous section. Press the **ERASE** menu key to permanently erase the waypoint from the 941X's memory. (Note: You can't erase it if it is used in a route—you must first erase it from the route. See "Changing a Route" on page 50 for more route editing information.)

Transferring Waypoints to a PC

If you store a large number of waypoints or routes in the 941X, or if your waypoints are the only records you have of important locations, you should consider making a copy of them by transferring them into a personal computer using special transfer software (provided by a third party vendor) and a Northstar loader cable (part #1100-LC). With this system, waypoints and routes can be copied, edited or plotted, and, most importantly, can be reloaded into your 941X in the event they are accidentally erased or lost due to equipment failure. Consult your authorized Northstar dealer for software and cable ordering information.

Creating Routes

A route is a sequence of waypoints stored in the 941X. You can store up to a maximum of 500 routes in the 941X's memory. There are two methods by which you can create a route: 1) constructing a route from waypoints already stored in the 941X's memory, and 2) saving a route as you travel it.



You may create a route from the waypoints stored in the 941X's memory by first pressing the **WAYPTS/ROUTES** key, and then pressing the **ROUTE LIST** menu key. The names of any routes already stored are displayed.

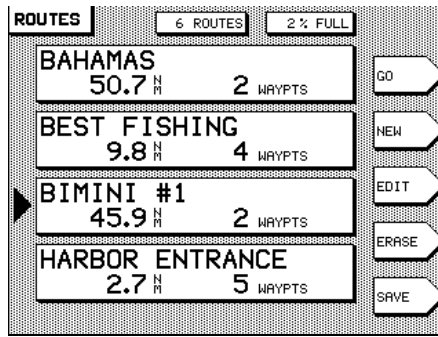

Press the **NEW** menu key. A screen is displayed asking you to enter the name of the new route.

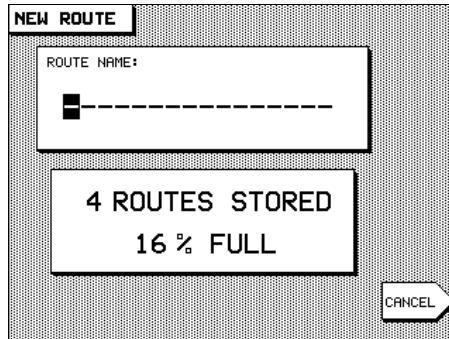

route name Enter the name of the new route using the keypad and cursor arrow keys, as described on page 36, and press **ENTER**. The **NEW ROUTE** waypoints screen will be displayed, ready for you to begin selecting waypoints to add to the route.

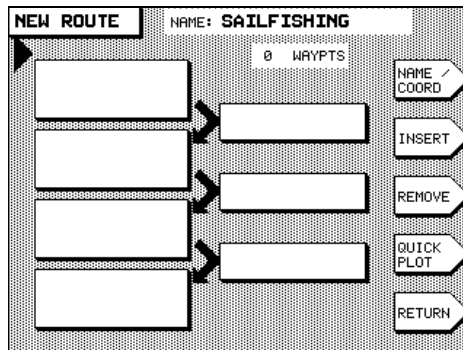

inserting waypoints

To add waypoints to the route, press the **INSERT** menu key. A list of stored waypoints is displayed.

SELECT WAYPT		PRESS *ENTER* TO SELECT WAYPT		ALPHA
BRIDGE	S 25°46.500' N	MACARTHUR CSHY	80°08.660' W	CANCEL
BROWNS	S 9960 14335.0	BROWN'S LEDGE	43912.0	NEW
DEVILB	S 9960 14235.0	DEVIL'S BRIDGE	43900.0	COORD OPTION
DOCK	S 25°47.285' N	SAN MARCO ISLAND	80°10.005' W	NEXT LIST

Scroll the waypoint list up or down using the cursor keys to designate the desired waypoint, and press **ENTER**. The selected waypoint is now in the route.

*Press the **NEXT LIST** menu key, if you wish, to select different waypoints from the **alpha**, **local** or **saved** lists. (Avoidance points cannot be used as waypoints in a route.)*

Repeat for each waypoint you wish to enter.

You can insert a waypoint in any part of a route. Waypoints are always inserted into the route at the point indicated by the arrow at the left of the screen. Move the arrow so that it is halfway between the two existing waypoints of the route where you want the new waypoint to be located. Follow the “inserting waypoints” procedure above for inserting this new waypoint into the route.

creating new waypoints during route entry

You can also create a new waypoint as you enter it into the route. After pressing **INSERT** from the **NEW ROUTE** waypoints screen, press **NEW** from the **SELECT WAYPT** screen. Enter the name (with description, if you wish) and coordinates of your new waypoint. Press **ENTER**. The new waypoint is now part of the new route and stored among the waypoint lists in the 941X's memory.

verifying entry

As waypoints are entered, the distance and bearing of each leg of your route are displayed on the **NEW ROUTE** screen. To see an overhead plot of the entire route, press the **QUICK PLOT** menu key. It is good practice to use these two features to check that the route matches your expectations, ensuring that no errors were made in selecting waypoints.

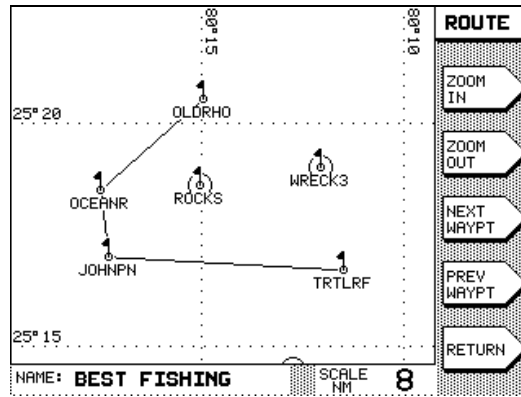

The entire route is displayed, with the plotter scale automatically adjusted to show all of the waypoints.

To see more detail about a portion of the route, use the **NEXT WAYPT** and **PREV WAYPT** menu keys to advance along the route or move back towards the beginning. Use **ZOOM IN** and **ZOOM OUT** to display a smaller or larger area. Press **RETURN** when finished viewing, to go back to the previous screen.

Saving a Route

A second way to create a route is to travel the length of the desired route, pressing the **SAVE/MOB** button at each location you wish to store in the route. The 941X's **SAVE ROUTE** function makes this a very simple process. In summary, you first tell the 941X that you wish to save a route as you travel, then press the **SAVE/MOB** button as you pass each waypoint, and then tell the 941X to stop saving the route when you come to the end of the route.

First, press the **WAYPTS/ROUTES** key, and then press the **ROUTE LIST** menu key to access route functions. The names of any routes already stored are displayed:

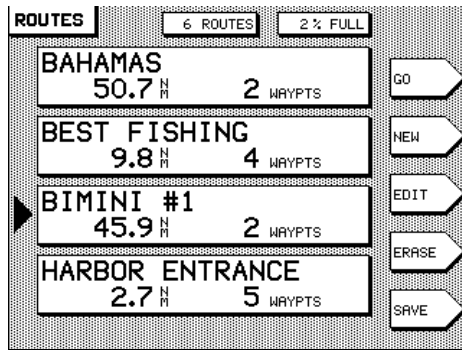

Press the **SAVE** menu key on the lower right of the display to instruct the 941X to begin saving a route automatically. A screen is displayed asking you to enter the name of the new route to be saved.

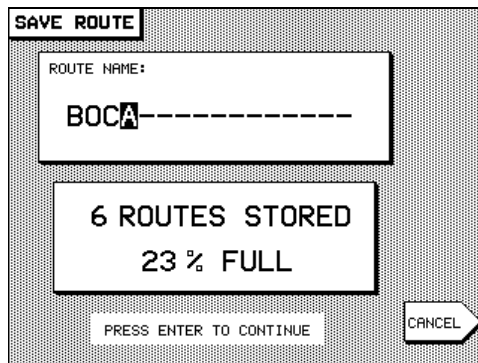

route name Enter the name of the new route to be saved, using the keypad and cursor arrow keys, and press **ENTER**. The 941X displays the message “SAVING TO: [route name]” at the bottom of the **ROUTES** screen confirming that your route is now being saved.

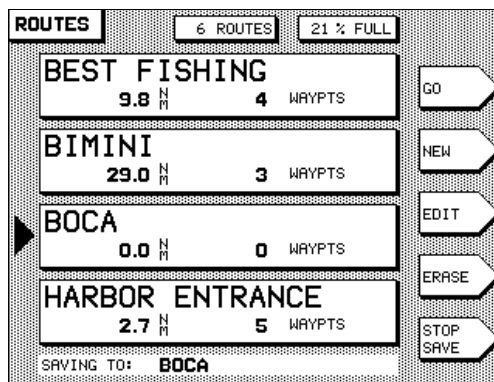

storing waypoints

As you pass the location of each new waypoint, press the **SAVE/MOB** key to the left of the display (not the **SAVE** menu key in the lower right of the screen). The boat's location will be saved as a waypoint in the unit's memory, and the waypoint will automatically be added to the route being saved. The waypoint will be stored with a name similar to (0001). The parentheses () indicate that the waypoint is part of a saved route, and the four-digit number is used to uniquely identify each waypoint. Each waypoint is automatically given a description consisting of the time and date when the waypoint was stored.

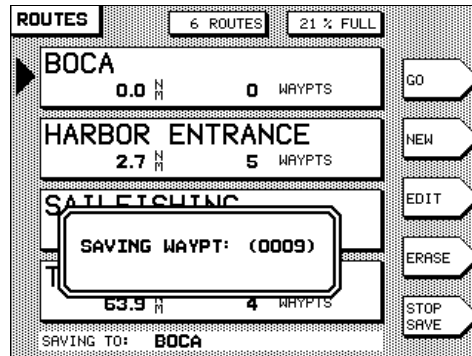

You can access any of the 941X's navigating functions while you are saving a route automatically, with the exception of editing the route you are presently saving. If, at any time, you are unsure as to whether you are still saving a route or not, press the **WAYPTS/ROUTES** key, then the **ROUTE LIST** menu key to display the **ROUTES** screen. If you are presently saving a route, the message "SAVING TO: " will be at the bottom of the screen.

ending the route

When you have reached the end of your new route, or if you wish to stop automatically saving the route at any time, go to the **ROUTES** screen (if you are not presently displaying it), as described above. Press the **STOP SAVE** menu key. The 941X will prompt you with a question window, asking if you want to "STOP SAVING TO ROUTE XXX?". Press **ENTER** for "YES." The "SAVING TO: " message at the bottom of the screen is extinguished.

Changing a Route

To make a change to a route stored in the 941X's memory, use the EDIT ROUTE function. Press WAYPTS/ROUTES and then the ROUTE LIST menu key to display the ROUTES screen.

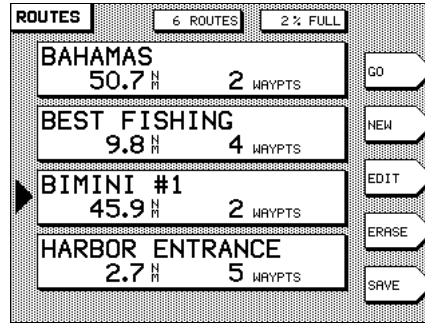

Use the up or down cursor keys to point to the route you wish to change. Press the EDIT key. The route name is displayed.

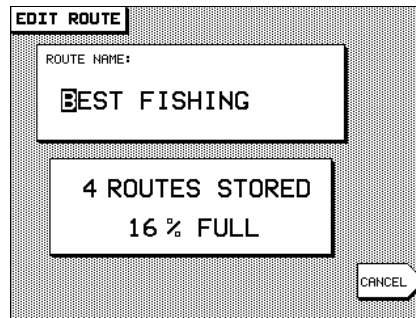

If you wish to change the route's name, do so now, then press ENTER. If not, press ENTER to continue.

A screen appears which displays the waypoints in the route and allows you to insert or remove waypoints from the route.

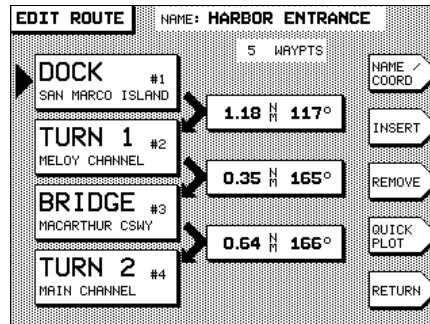

inserting waypoints

To insert a new waypoint, use the up and down cursor keys to move the pointer to the spot between the two existing waypoints where you want to make the insertion, and press the **INSERT** menu key. A screen listing waypoints is displayed.

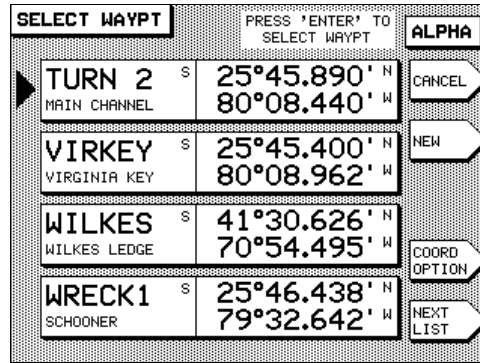

Move the cursor to select the waypoint from the displayed list, and press **ENTER**. You will see the selected waypoint now in your route.

removing waypoints

To remove a waypoint from the route, use the up and down arrow keys to move the pointer to the waypoint, and press the **REMOVE** menu key, and then **ENTER**.

editing a route you are following

If you make changes to a route you are currently navigating along, remember that the modified route is stored back in the 941X's memory, but these changes do not appear in the copy of the route the 941X is following.



To make these changes take effect, you must start following the route again (see page 59).

other waypoint functions

To display each waypoint's coordinates instead of its name and description—while editing or creating a route—press the **NAME/COORD** menu key.

GO ALONG ROUTE		NAME: HARBOR ENTRANCE	
DOCK #1	SAN MARCO ISLAND	ETA: 9:43 AM TODAY	GO
TURN 1 #2	MELOY CHANNEL	1.18 N M 117°	QUICK PLOT
BRIDGE #3	MACARTHUR CSWY	0.35 N M 165°	REVERSE
TURN 2 #4	MAIN CHANNEL	0.64 N M 166°	NAME COORD
		USUAL SOG: 10 K T	USUAL SOG

To plot an overhead view of the route, press the **QUICK PLOT** menu key.

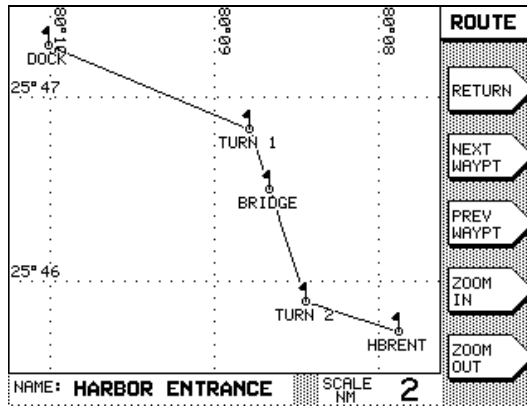

5

Waypoint and Route Navigation

Quick-Start Waypoint	54
Navigating to Waypoints	55
Navigating Along Routes	59
Restarting the Course Line	61

In this section, we'll begin navigating to specific waypoints and along routes, and show you how to get back on course, or follow a new course line to your destination.

Quick Start Waypoint

The 941X's "Quick Waypoint" feature allows you to enter coordinates and start navigating in one quick and easy sequence.

Press the **WAYPTS/ROUTES** key, and then press the **QUICK WAYPT** menu key. A screen for entering waypoints appears.

QUICK WAYPT

NAME: -QUIK-
DESC: QUICK WAYPOINT

LAT: 25°46.786' N
LON: 80°08.773' W

COORD TYPE
N-S-E-W
CANCEL

Key-in the coordinates of the waypoint (just as you would normally store a waypoint) and press **ENTER** twice.

The 941X stores the waypoint as a "-QUIK-" waypoint, and will immediately begin navigating to it.

coordinates

To change the type of coordinates you want to enter—from lat/lon, to distance and bearing, or to loran TDs—press the **COORD TYPE** menu key to show the type you wish to use.

Coordinates may be entered as:

1. latitude/longitude of any point in the world
2. distance and bearing from "here" (your present position), or from any waypoint in the 941X's memory
3. loran TDs (make sure the GRI displayed is correct; change it if necessary).

The coordinates you enter will be stored in the 941X's memory as a waypoint named "-QUIK-." This waypoint's coordinates will be overwritten the next time a QUICK waypoint is entered.

WAYPOINT TIP

You can specify a waypoint to navigate to, and store it permanently in the 941X's database in one operation, if you like. While in the QUICK WAYPT entry screen, just move the cursor arrow up to the waypoint's name and change it from -QUICK- to its permanent name before pressing ENTER. To make a previously-entered QUICK waypoint become a permanent waypoint, just go to a waypoint list screen and edit the name (and description, if you wish).

Navigating to Waypoints

To navigate to a waypoint already stored in the 941X, first display it using one of the four waypoint list screens: press WAYPTS/ROUTES, then the WAYPT LIST menu key. Use the up and down cursor arrow keys to move the large arrow on the left of the screen so that it points to the waypoint you want to navigate to. Then press the GO TO menu key, and then ENTER.

WAYPOINT TIP

Since the waypoints you navigate to are usually nearby, the LOCAL waypoint list is often the best list to use for finding the waypoint in the database.

WAYPTS	37 WAYPTS	34 % FULL	LOCAL
▶ OLDRHO S	25°20.563 N		GOTO
OLD RHODES BANK	80°14.972 W		
WRECK2 S	25°18.759 N		ADD
	80°14.598 W		EDIT
ROCKS S	25°18.621 N		COORD OPTION
	80°16.825 W		
OCEANR S	25°18.505 N		NEXT LIST
OCEAN REEF HBR	80°17.480 W		

The 941X will automatically switch to the STEER display to show information for navigating to the waypoint. You can also press the STEER key to display this information at any time. Two versions of the screen are available to choose from.

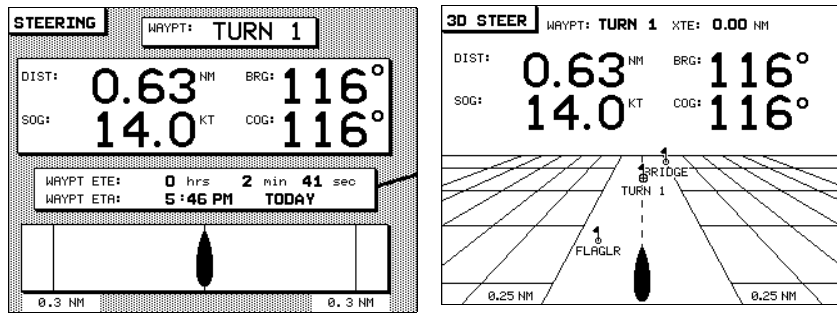

choosing a steering screen

The first **STEERING** screen is a traditional display showing cross-track distance at the bottom of the screen (how far off your intended course line you may be) combined with numeric information depicting the distance to your destination waypoint, your present bearing to that waypoint, your present SOG, and your present COG.

The “3-D” steering screen is a waypoint “heading-up” display showing the waypoints between you and the destination waypoint, and your position relative to the course line for precision steering. Both steering screens are intended to guide you precisely along a course line which might follow a harbor channel, or a line between shoals and sandbars.

distance and bearing

The first **STEERING** screen displays your distance and bearing to the waypoint, along with your Speed-Over-Ground and Course-Over-Ground on the upper part of the readout. The digits are large and can be read from a distance. An arrow between the SOG and COG displays points upwards when the trend of your speed is increasing, and down when it is decreasing.

other information

The center of the screen has a user-selectable area which can be set to display any of the information listed below. Press the middle menu key to change the type of data displayed:

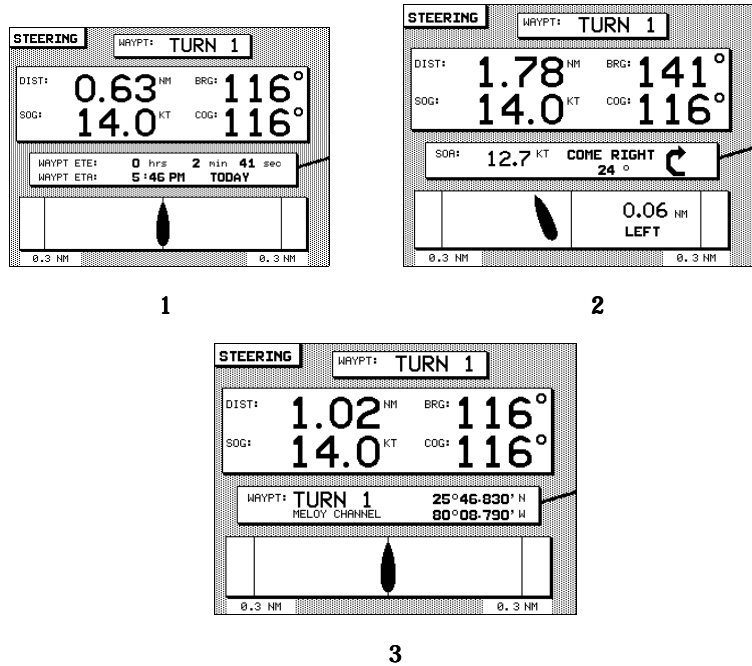

1

2

3

In the first steering screen above, a line extends from the data box in the center of the screen to a menu key. Each press of the menu key changes the data displayed in the box among three choices, as follows:

1. Estimated Time En Route (ETE) to the waypoint, and Estimated Time and Date of Arrival (ETA)
2. Speed of Advance (SOA) and Heading Correction
3. Waypoint's name and description, and its coordinates

off-course distance

The lower part of the screen displays your off-course distance, using a picture of your boat to show your distance from the course line. In addition, the direction of the boat on the screen indicates the direction your boat is actually traveling. (Note: this may not be the same as your heading if any current or wind is present.) When the picture of your boat points towards the course line, you are moving closer to the line. When it points parallel to the course line, you are keeping a constant distance from the line. When it points away from the course line, you are moving further from the line.

Your distance from the course line is also displayed in numbers at the bottom of the screen. See page 85 for customizing the cross-track display format.

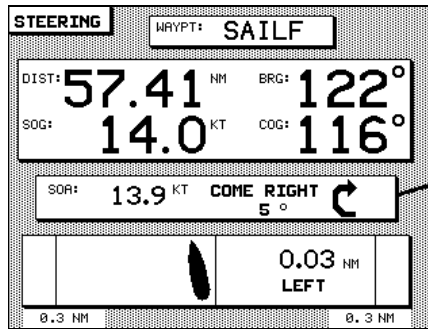

Two vertical lines near the edge of the screen indicate the limits of off-course distance. An alert message will be given if these limits are exceeded, and the image of your boat will flash on and off. Press the **STAR** button to display the alert message, then the **CLEAR ALARM** menu key to acknowledge and clear it.

NOTE

As you pass a waypoint while following a route, the image of the boat may swing around vigorously as it points to the waypoint you are passing. When the 941X switches to the next waypoint, the boat image will snap back to pointing straight ahead.

The 3-D STEER display features a three-dimensional view of your boat, the current waypoint, the course line to the waypoint, and the locations of any other nearby waypoints. It is intended to provide a comprehensive picture of your progress toward the waypoint.

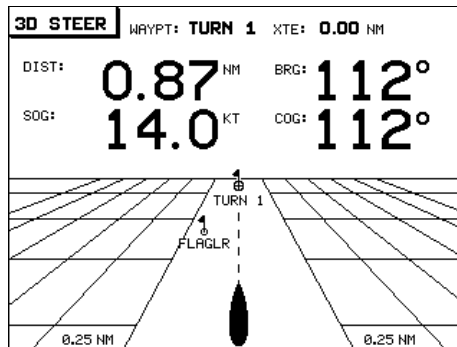

Navigating Along Routes

To follow a route that has been stored in the 941X's memory, press the WAYPTS/ROUTES key, then the ROUTE LIST menu key. Use the cursor keys to select the route you wish to follow, and then press the GO menu key. The first four waypoints of the route are displayed.

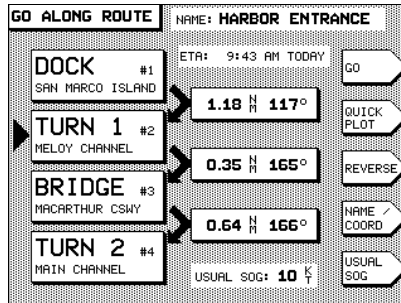

starting the route

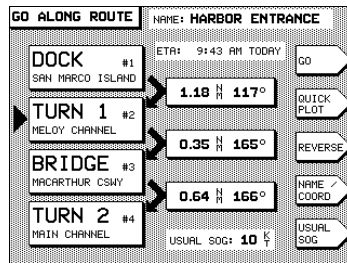

1

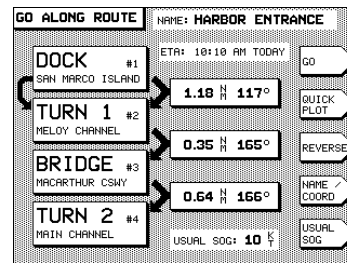

2

Notice that the arrow shape alternates as you move the cursor up and down. The first arrow shape designates a single waypoint of the route. The second designates a leg connecting two waypoints. The two shapes allow you to start following a route in either of two ways:



1. **DIRECT TO WAYPOINT:** You may navigate directly from your present position to a designated waypoint. To start on a waypoint other than the first, use the cursor keys to move the pointer to the desired waypoint, as in screen #1 above. Press the GO menu key, then ENTER.
2. **ALONG A LEG:** You may tell the 941X that you want to navigate along a designated leg of the route. Move the cursor down until it

changes to a connecting arrow between the two waypoints, as in screen #2 above. Press the **GO** menu key, then **ENTER**.

To start following the route, select the waypoint or leg you want to start on, press the **GO** menu key, then **ENTER**.

planning ETA to any waypoint

Before you actually start the route, you can display planning information about the route in the **GO ALONG ROUTE** screen. An estimate of the time required to travel to the selected waypoint is displayed near the top. As you scroll the pointer up or down, the ETA will change for each waypoint. This estimate is based on the Speed-Over-Ground figure displayed at the bottom of the screen.

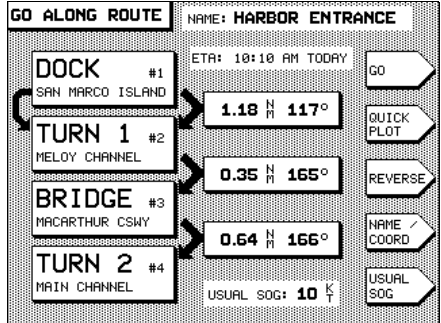

To change this figure, press the **USUAL SOG** menu key and enter the new value to be used in calculating the time. Use the cursor arrow keys again to scroll through the Estimated Times of Arrival for different waypoints of the route.

To access the **USUAL SOG** and waypoint **ETA** features from any screen, proceed as though you were going to follow a route by pressing the **WAYPTS/ROUTES** key, then **ROUTE LIST**, then select the route you wish to view. Press **GO** to display the **ETA** of each waypoint in the route and the **USUAL SOG** window at the bottom of the screen. To exit without actually following the route, press any function key.

distance & bearing

The distance and bearing of each leg are displayed near the center of the screen.

waypoint coordinates

To display the coordinates of each waypoint in place of the name and description, press the **NAME/COORD** menu key.

quick plot

To plot an overhead view of the route, press the **QUICK PLOT** menu key. When displaying the plot, you may use the **NEXT WAYPT** and **PREV WAYPT** menu keys to advance along the route or move back towards the beginning.

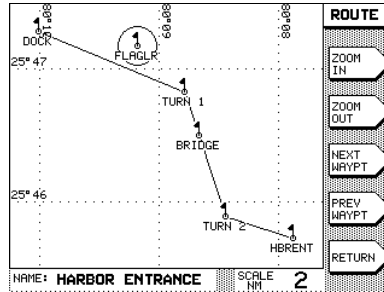

Use **ZOOM IN** and **ZOOM OUT** to display a smaller or larger area. When you have finished looking at the plot, press **RETURN** to go back to the previous screen.

Restarting the Course Line

When navigating from one waypoint to another, you may find you have wandered off the intended course line. Perhaps you may have avoided an obstacle, or simply drifted slightly off-course. Whenever you are off-course for any reason, you may choose either of two methods for getting back on course.

After passing the obstacle, you may steer the boat back to the original course line using the Cross-Track error display (Course 1 below), and continue to the waypoint.

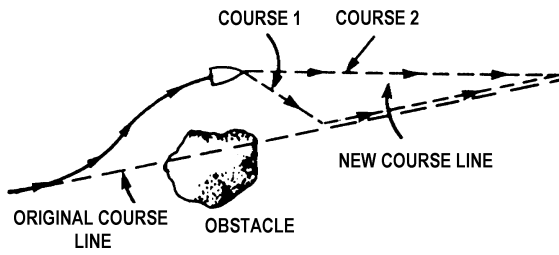

If you do not need to return to the original course line, you can continue directly to the waypoint (Course 2) using the restart function described below.



To restart your course line from your present position, display the NAV LOG screen or the POSITION PLOTTER screen. Press the RESTART menu key, then the ENTER key. The 941X will recompute the course line to extend from your present position directly to the next waypoint, re-setting your cross-track error to zero.

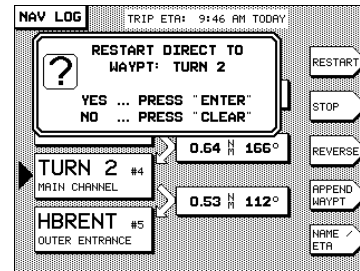
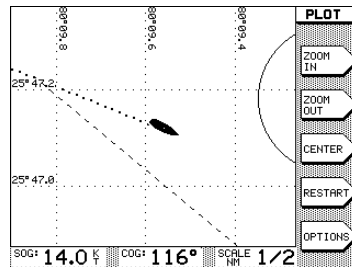

6

The NAV LOG Function

What NAVLOG Does	64
Logging Your Trip	65
Changing Your Trip	65
Adding Waypoints to the Trip	66

The Northstar 941X's NAV LOG function provides a quick and easy way to check on your progress along a trip, and to make changes to it while you travel.

What NAV LOG Does

THE Northstar 941X's NAV LOG feature helps you plan and log your trip. It contains the actual series of waypoints that you follow along your route. When you navigate to a waypoint or along a route from the 941X's memory, the string of waypoints are copied into the NAV LOG, which acts as a kind of "scratchpad" for monitoring your progress. You can modify NAV LOG's route in any way you want without affecting the original route, which remains safely stored in the unit's memory.

NAV LOG provides two main functions: It shows your progress along your trip, and it lets you easily change the remainder of your trip.

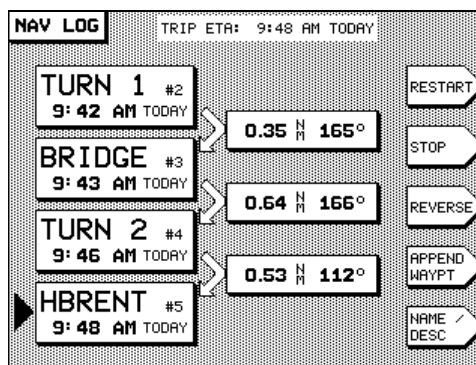

ETA and ETE Information for safe and efficient planning of your trip is updated as you travel. Your Estimated Time of Arrival (ETA) at the last waypoint in the route is shown at the top of the screen, and the Estimated Time Enroute (ETE) to each waypoint is shown below each waypoint name.

pass status A darkened arrow connecting the right ends of two waypoint boxes indicates you have completed that leg of the trip.

restart You may restart at any leg or to any waypoint of the route by moving the cursor arrow to the waypoint or leg and pressing the **RESTART** menu key.

reversing the trip

You can reverse the trip at any time (navigating to route waypoints in reverse order) by pressing the **REVERSE** menu key.

appending waypoints

Waypoints may be added to the trip by pressing the **APPEND WAYPT** menu key. Any waypoints added to the trip in NAV LOG are not permanently appended to the route in the 941X's memory. To make permanent changes to the route, you must use the EDIT ROUTE functions, as described on page 50.

Waypoints are automatically entered and organized in NAV LOG when you first navigate (**GO**) to a waypoint or along a route.

Logging Your Trip

Press the **NAV LOG** key at any time to display the list of waypoints you are currently navigating along. Use the up and down cursor arrow keys to scan through the entire list to show any waypoint you wish. The distance and bearing of each leg is displayed. For each waypoint, you can display either the waypoint's description, or the time of arrival at the waypoint. Press the **NAME/ETA** menu key to select one or the other.

The time of arrival displayed is the Estimated Time of Arrival (based on your current speed) for waypoints you have not yet passed. Actual Times of Arrival are shown for waypoints you *have* passed.

Remember, estimated times are just that—estimates—and may be inaccurate. This is because your Speed-Over-Ground will be affected by any changes in direction, even slight changes brought about as you pass through varying currents.

Changing Your Trip

Press the **NAV LOG** key, as above, to display the waypoints of your current trip. You may modify the remainder of your trip by:

- adding a waypoint to the end of the trip
- skipping to any waypoint within the trip
- reverse the trip from present position to follow it back to the beginning

Under NAV LOG, the distance and bearing of each leg are displayed. You can easily read the direction of the next leg of your trip from this display.

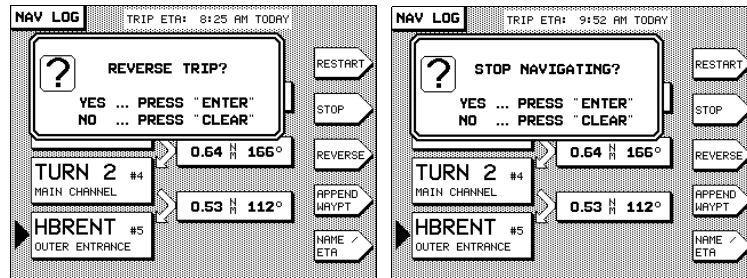

Adding Waypoints to the Trip

Press the NAV LOG key to display the waypoints of your current trip. To add a waypoint to the end of the trip, press APPEND WAYPOINT. A list of the waypoints stored in memory is displayed. Use the up and down cursor arrow keys to select the desired waypoint. (Press NEXT LIST, if you wish, to display the waypoints list in a different order.) Press ENTER to add the waypoint to the NAV LOG. Repeat for any other waypoints you want to add.

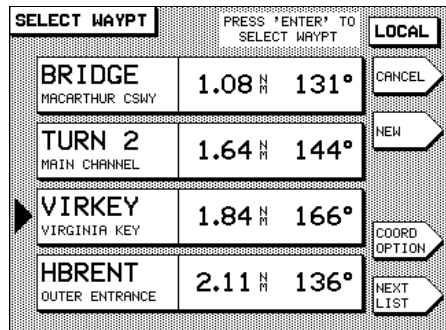

7

Other Special Functions

Alarms	68
Screen Backlighting	71
TideTrack™	71
Internal Differential Beacon Receiver	74

This section covers several special functions that enable you to: change the 941X's audible alarms and screen appearance; navigate using the unique TideTrack™ feature; get the most out of the high-precision positioning capabilities of your internal or external Differential GPS (DGPS) receiver.



Several special 941X functions are controlled by the **STAR** function key (★). These include alerts and alarms, TideTrack™ functions, and setup functions.

Alarms



The Northstar 941X has a number of automatic alarms that can alert you of special situations. For example, when you are approaching a waypoint, the 941X signals you with a distinctive “beep” and a flashing exclamation point symbol on the screen.

At any time, you can press the **STAR** button (★) to access the **ALARMS & BACKLIGHT** screen which displays the cause of the most recent alarm.

The 941X’s alarm types and descriptions are:

TYPE	DESCRIPTION	AUTO CLEAR?
CLOSE	you have come within 900’ of the arrival circle of the current waypoint (arrival circle radius set from ALARMS & BACKLIGHT screen)	YES, after 5 seconds
ARRIVE	you have entered the arrival circle of the current waypoint	YES, after 5 seconds
PASS	while navigating to waypoint, perpendicular to track passed, but arrival circle was not entered	YES, after 5 seconds
CHANGING	switching to next leg of route (“NOW NAVIGATING TO . . .”)	YES, after 5 seconds
AVOIDANCE AREA	avoidance area circle has been entered	NO: potential hazard ahead
ANCHOR DRAG	anchor is dragging beyond limit set from ALARMS & BACKLIGHT screen	NO: requires immediate attention
NO LORAN FIX	no position fix received from external loran	YES, when condition clears
DGPS LOST	DGPS data timeout exceeded	“
NO GPS FIX	no position fix from GPS	“
NO LORAN DATA	communication failure with external loran	“
NO GPS DATA	communication failure with GPS	“
POOR LORAN FIX	BLINK, CYCLE or LOW SNR detected at loran	“
CROSS-TRACK LIMITS EXCEEDED	off-course in excess of limits set in CROSS TRACK ALARM	only when within limits

Though most alarm conditions are “auto clearing” after approximately five seconds, and do not require any user action, two alarms—**AVOIDANCE AREA** and **ANCHOR WATCH**—must be acknowledged before the exclamation point can be cleared from the screen.

The most recent instance of an alarm type (waypoint, communications, avoidance area, anchor and cross-track alarms) is retained in the 941X’s memory. This is helpful for viewing those “auto-clear” alarms that you may have been unable to acknowledge before the flashing exclamation symbol was automatically cleared. Each successive press of the **CLEAR ALARM** menu key displays the most recent message for each type of alarm.



Four of the alarm controls are adjustable, as described below. To change any of these, use the up and down cursor keys to move the arrow on the screen to the control you want to edit. Press the **EDIT ALARM** menu key. Use the up or down arrow keys to select the status you want, and finally press **ENTER**.

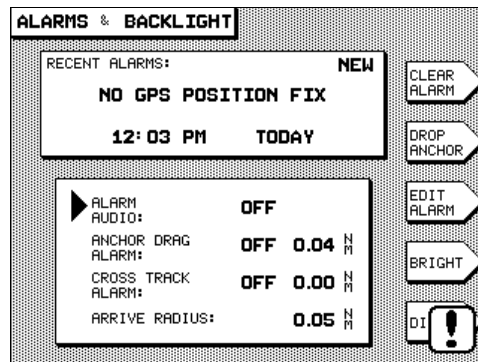

alarm audio The audio beep that alerts you to alarm conditions can be turned on or off.



1. Select **ALARM AUDIO**, using the up/down cursor arrow keys.
2. Press the **EDIT ALARM** menu key.
3. Use the up/down cursor arrow keys to display **OFF** or **ON**.
4. Press **ENTER** to make your selection, or **OFF** to leave it unchanged.

When **ALARM AUDIO** is set to ON, the 941X will audibly alert you to any of the alarm conditions turned ON at the **ALARMS & BACKLIGHT** screen.

anchor watch

The anchor watch feature of the 941X will sound an alarm if the unit detects that the boat has moved a specified distance away from an initial position.



1. Press the **DROP ANCHOR** menu key at the spot where the anchor is dropped.
2. Press **ENTER** in response to the question window prompt.
3. Move the cursor arrow to **ANCHOR ALARM** and press the **EDIT ALARM** menu key.
4. Use the up/down cursor keys to turn the alarm ON.
5. Move the cursor to the right and use the keypad to specify the distance the boat can be expected to move on its anchor chain (plus a safety factor to allow for GPS or loran inaccuracy).
6. Press **ENTER**.

Remember to turn the **ANCHOR WATCH** alarm off before intentionally moving away from the anchor drop point.

cross track alarm

The cross track alarm allows you to specify the maximum distance the boat will be permitted to move from the track line without sounding an alarm. You can turn the cross track alarm on or off, and specify the alarm distance from the track line.



1. Move the cursor arrow to **CROSS TRACK**.
2. Press the **EDIT ALARM** menu key.
3. Choose whether you want the cross-track alarm **ON** or **OFF** with the up/down cursor keys.
4. If you want to change the limit at which the cross-track alarm will alert you, use the right arrow cursor key to move to the digits field.
5. Using the keypad, specify the distance at which you want to be alerted, and press **ENTER**.

arrive radius

The **ARRIVE RADIUS** alarm signals you when you come within a specified distance of the next waypoint. You can specify the distance of the radius around waypoints down to 0.01 nm.



1. If you want to change the limit at which the arrive radius alarm will alert you, move the cursor arrow to **ARRIVE RADIUS**.
2. Press the **EDIT ALARM** menu key.
3. Using the keypad, specify the distance at which you want to be alerted, and press **ENTER**.

NOTE: Keep this distance very small because the 941X will automatically begin to sequence to the next waypoint when you come within the arrival distance you have set for the current waypoint.

dgps alarm

The **DGPS ALARM** signals when the 941X has operated without differential corrections beyond the DGPS data timeout limit. (See “DGPS data timeout,” beginning on page 89, for details.)



1. If you want to activate the audible DGPS timeout alarm, move the cursor arrow to **DGPS ALARM**.
2. Press the **EDIT ALARM** menu key.
3. Use the up/down cursor keys to turn the alarm on or off, and press **ENTER**.

Screen Backlighting

To change the level of backlighting of the unit’s screen and keys:

1. Press the **STAR** key to display the **ALARMS & BACKLIGHT** screen.
2. Press the **BRIGHT** menu key to make the lighting brighter.
3. Press the **DIM** menu key to dim the lighting.

TideTrack

The 941X calculates tide information for any of over 3,000 NOS/NOAA tide stations. The entire U.S. coastline—including Alaska and Hawaii—is covered, plus many Caribbean islands and western Canada. Tides may be

displayed for any date from 1994 to 2010. Data is from the official tide table predictions and should be as accurate as the printed tables. (Please refer to *Tide Tables*, published by the NOS/NOAA, Rockville, Maryland 20852, for more information on tides.)



To use TideTrack, press the STAR key until the TideTrack graphic is displayed.

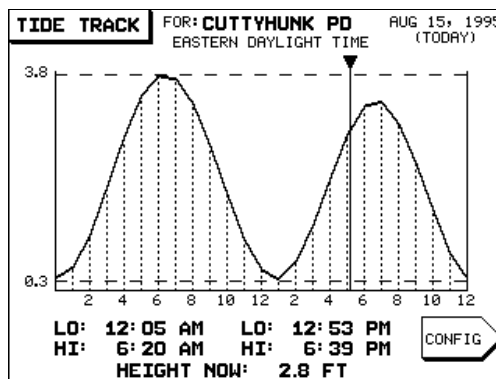

The water height for any 24-hour period is displayed for the selected NOAA tide station.

At the top of the screen the selected tide station and the selected day are displayed.

The center of the screen shows a graphic representation of the tide height for the entire day. Maximum and minimum heights are shown as dashed horizontal lines labeled with the height in feet. Mean Lower Low Water (MLLW) is shown as a solid line near the bottom of the picture. A vertical line and arrow are positioned to show the tide level for the current time.

At the bottom of the screen, the times of the day's high and low tides are shown for that location, along with the height at the present time.

choosing a nearby tide station

You may display tide information for any of over 3000 NOAA tide stations stored in the 941X. You can select from any of the nine tide stations closest to your present position, or you may select from any of nine tide stations closest to any waypoint stored in the 941X.



To choose a nearby tide station, press the CONFIG key while viewing the TIDE TRACK screen.

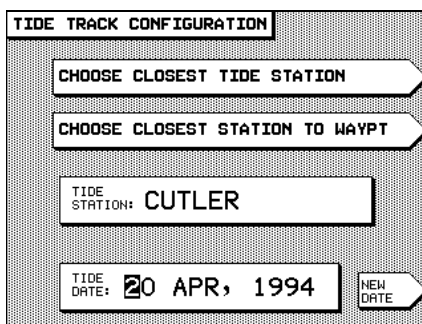

Press the CHOOSE CLOSEST TIDE STATION menu key. The 941X will search for the nine closest stations to your present position and present a list like the following, organized by closest station at the top:

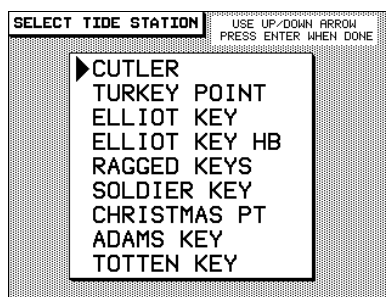

Use the up and down arrow keys to point to the desired station, and press ENTER twice to return to the TIDE TRACK screen and display the tides for that station.

choosing a distant tide station

The 941X will display NOAA tide stations within 100nm of any waypoint stored in its memory. (You can always store a waypoint just for the purpose of locating tide stations in that area, at a later date. Refer to “Creating Waypoints,” on page 37, for more information on storing a waypoint.)



To choose a tide station near a waypoint, press the CONFIG key on the TIDE TRACK screen. Press the CHOOSE CLOSEST STATION TO WAYPOINT menu key. A list of the 941X’s waypoints is displayed.

SEARCH POSITION		PRESS 'ENTER' TO SELECT WAYPT	ALPHA
▶ VIRKEY VIRGINIA KEY	1.89 N M	164°	CANCEL
HBRENT OUTER ENTRANCE	2.18 N M	136°	
KEYBIS KEY BISCAYNE	3.51 N M	175°	COORD OPTION
OLDRHO OLD RHODES BANK	27.0 N M	195°	NEXT LIST

Use the up or down cursor arrow keys to point to the desired waypoint, and press ENTER. The 941X will search for, and present, the nine closest tide stations to this waypoint. Now, use the up and down arrow keys to point to the desired station, and press ENTER twice to return to the TIDE TRACK screen and display the tides for that station.

selecting a day

The TIDE TRACK screen normally displays tide information for today's date.



To enter a different date, press the CONFIG menu key; the TIDE TRACK CONFIGURATION screen is displayed. Press the NEW DATE menu key. The first character of the present tide date flashes. If necessary, press the right cursor arrow to move to the month or digit you wish to change. To change a digit, press that key on the keypad. To change the month, use the up and down cursor arrow keys. When the date is correct, press ENTER twice. Tide information for the new date is now displayed.

Internal Differential Beacon Receiver

As we previously discussed in "Comparing GPS and Loran," beginning on page 5, use of differential corrections significantly enhances the accuracy and performance of your 941X. One source of differential corrections is Northstar's fully automatic beacon receiver, which may be connected externally (part #8800) to the 941X, or contained internally (#8500). Or, you may connect another source of corrections externally (see page 124 for further details on interfacing to external sources of differential corrections).

The Northstar beacon receiver takes corrections broadcast by shore-based marine radio beacons situated along most of the U.S. coastline.

These corrections are used by your 941X to improve its position accuracy to 10 meters—or better—with 2-5 meters accuracy commonly available.

Differential corrections are invaluable when navigating in narrow or congested areas (such as ports and waterways), or whenever extreme accuracy is required for locating a precise area (retrieving lobster pots, returning to a diving spot, etc.).

Northstar beacon receivers require no manual operation. They automatically tune to the appropriate beacon frequency as you move from one beacon coverage area to another, or as weather conditions change. Available radio beacon signals are constantly evaluated for signal quality by the receiver, and only the best station is selected. As you travel, the Northstar beacon receiver is prepared to switch to another frequency automatically, as conditions require.

automatic mode

The 941X, with a Northstar beacon receiver, enters automatic differential mode as soon as SC-104 DGPS corrections are received and requires no further supervision, as far as differential operation is concerned. The beacon receiver maintains automatic operation by using two independent receiver channels. Channel 1 tracks the best available beacon signal (the one with the lowest data error rate) and sends the demodulated DGPS corrections to the 941X GPS receiver. Channel 2 continuously scans the entire beacon frequency band (283.5 to 325kHz), locating and measuring received DGPS beacon signals. The unit then stores this information as a DGPS beacon “directory” in its battery-powered memory.

If the signal being received and monitored by Channel 1 degrades for any reason, the unit tries to select a better frequency from its beacon memory. This allows it to switch to the best beacon signal before your GPS accuracy can be affected.

Automatic mode can normally be used for all but specialized applications.

manual mode

At any time, you can override automatic beacon station selection of the beacon receiver by issuing tuning commands from the keypad. In man

ual mode, the beacon receiver will output DGPS corrections only from the selected station. Though the need for manual operation is rare, it is easily accessed from your 941X keypad.

To manually choose a beacon, you must select the frequency and baud rate (the beacon's data transmission speed) of the desired beacon.



1. To first change the frequency, press the **STAR** key until you display the **USER CUSTOMIZATION** screen.
2. Press the **RECEIVER OPTIONS** menu key. Move the cursor to **BEACON FREQUENCY** and press the **EDIT** menu key.
3. Press the down cursor key once, to change from “**AUTO**” to “**MANUAL**.” A beacon transmitter frequency will appear to the right of the word “**MANUAL**.”
4. Use the right cursor key to highlight the digits you wish to change. Enter the appropriate frequency and press **ENTER** when you are done.

You may also manually set the baud rate for the selected beacon frequency. *However, it is strongly recommended to leave the **BEACON BAUD RATE** setting at **AUTO**.*

NOTE

*A non-Northstar **external** beacon receiver cannot be manually controlled by the 941X, unless it supports the **MX50R** control protocol. Refer to the beacon receiver manufacturer's instructions to determine if this control protocol is supported.*

**DGPS data
timeout**

If the beacon receiver stops receiving differential data, the 941X will continue navigating for a short time using the old DGPS corrections. Reception of the DGPS data can be interrupted by bad weather, severe thunderstorms, extreme distance from the beacon, etc.

You may allow the 941X to navigate for a set period of time using this old data with no DGPS interruptions. To change the data “timeout” period, refer to page 89.

8

Customizing the 941X

Time of Day	78
Display Options	78
Navigation Options	82
Port Setup Options	90
Service Options	91
Geodetic Datum	94

This section explains the various options available to you for customizing the way your 941X displays information to you, computes navigation data, and “talks” to other devices. Each option is changeable at any time, according to your specific needs.

Time of Day

Press the **STAR** key until you display the **TIME OF DAY** screen. The time, date, local time zone, and time of today's sunrise and sunset are shown.

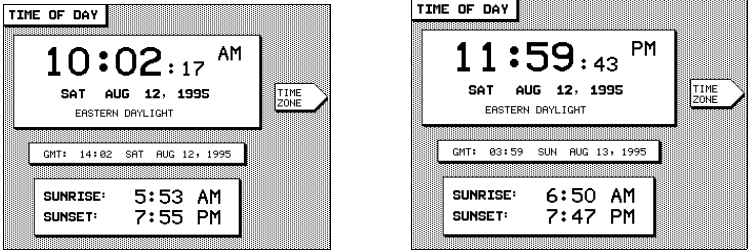

Also displayed is the current time expressed as "GMT" (Greenwich Mean Time). Note that the day of the week in Greenwich, England may be different from the day in your local time zone (right screen, above).



To change the time zone used for the time display (both here and in other time displays), press the **TIME ZONE** menu key, and use the up or down cursor arrow keys to select the desired zone and standard or daylight time. Press **ENTER** to use the new time zone.

Display Options

To access the 941X's display options, press the **STAR** key until you display the **USER CUSTOMIZATION** screen.

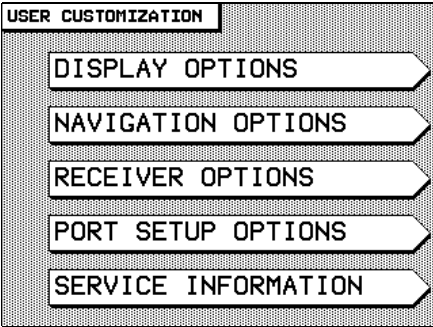

Press the **DISPLAY OPTIONS** menu key. The following choices are shown:

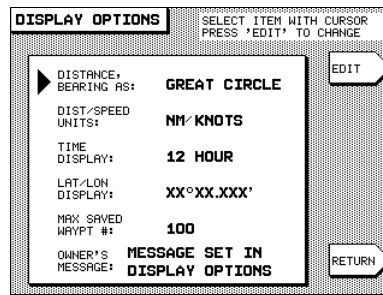

To change any of the options (described below), select it by using the cursor keys to move the arrow at the left of the screen, and then press the **EDIT** menu key. The field will begin to flash, waiting for you to change it using the up/down cursor keys or the keypad.

distance, bearing as

The 941X offers you the choice of calculating the distance and bearing to your intended destination as either a **GREAT CIRCLE** route or a **RHUMB LINE**.

The shortest distance between any two points on the surface of a sphere is called a Great Circle route. It appears as a curved line on a Mercator chart and is the default method of calculating distance and bearing to waypoints by the 941X.

Rhumb line navigation maintains a constant true direction to your destination (seen as a straight line on a Mercator chart), but is a somewhat longer route to travel over great distances than the Great Circle calculation. A Rhumb Line course may be desired if a Great Circle route is likely to take you precipitously close to bad weather or an unavoidable land mass.

dist/speed units

You may choose between nautical miles and knots, kilometers and kilometers per hour, or statute miles and miles per hour, for the 941X's various distance and speed displays, respectively.



To change this option, press **EDIT**, then use the cursor keys to scroll among the available choices. Press **ENTER** to make your selection, or **CLEAR** to leave the option unchanged.

NOTE

*This option determines whether feet or meters will be used in the **STEERING** screen's **CROSS-TRACK** display, and in both steering screens' distance-to-waypoint displays when **HIGH** is selected as the **STEER DIST PRECISION** option (both selected under **NAVIGATION OPTIONS**—see pages 85 and 86, respectively).*

time display (DISPLAY OPTIONS)

Time of day may be displayed in either 12- or 24-hour format. The option you select here affects all of the 941X's time-related displays, including high and low tides, sunrise/sunset, and ETA.



To change this option, press **EDIT**, then use the cursor keys to scroll among the two choices. Press **ENTER** to make your selection, or **CLEAR** to leave the option unchanged.

lat/lon display (DISPLAY OPTIONS)

You may adjust the precision of the 941X's latitude and longitude position displays from degrees, minutes and seconds (two digit places, or **.XX**), to degrees, minutes and thousandths of minutes (three digit places, or **.XXX**).



To change this option, press **EDIT**, then use the cursor keys to scroll among the two choices. Press **ENTER** to make your selection, or **CLEAR** to leave the option unchanged.

max. saved waypoint # (DISPLAY OPTIONS)

The 941X automatically assigns a sequential waypoint number for each point stored using the **SAVE/MOB** button. When this number reaches the designated value set using this function, the unit starts over at 1 (displayed as **-S001-**), and overwrites any old saved waypoint already designated as number 1. You can set the maximum number of saved waypoints which the 941X will store before overwriting old saved points (see below). For many applications, you may wish to set this maximum number to a small value, such as five or ten, provided you promptly rename any saved waypoints you wish to retain, before they are overwritten.



To change the maximum saved waypoint number:

1. Move the cursor to this option and press the **EDIT** menu key. The cursor will begin to flash in the first digit field.
2. Using the numeric keypad, enter the value you want—up to a maximum of 199—and press **ENTER**. For one- or two-digit values, enter a zero as the leading digit(s).

The 941X will now automatically number your saved waypoints up to the value you have set, at which point it will then begin to overwrite previously-saved waypoints with your new ones.

owner's message **(DISPLAY OPTIONS)**

To provide a substantial measure of theft protection for your Northstar 941X, you may enter a personalized owner identification message using an access code mailed to you when you return your product registration card to Northstar. This function asks you to enter this special four-digit code before you can change the owner's message.

You can enter your individual owner ID message once you have received your registered owner access code card:



1. Press the **STAR** key until you display the **USER CUSTOMIZATION** screen.
2. Go to **DISPLAY OPTIONS** and move the cursor arrow down to **OWNER'S MESSAGE:**.
3. Press the **EDIT** menu key. A question window will appear, asking you to enter your password.
4. Enter the "access code" number from your Northstar ID card and press **ENTER**. The first character block of the owner's message will flash.
5. Enter the message (up to two lines) you want displayed each time you power-up your 941X, and press **ENTER**.

Your message remains unchangeable from this point on, without first entering your specific access code number and repeating the above procedure. The 941X will allow three attempts to enter the correct access code; after that, all operations will "freeze," requiring the user to shut power off, then turn it back on again in order to resume functioning.

Press the **RETURN** menu key to return to the **USER CUSTOMIZATION** screen.

Navigation Options

The following options control aspects of navigation and the use of GPS and Differential GPS. Press the **STAR** key until you display the **USER CUSTOMIZATION** screen. Press the **NAVIGATION OPTIONS** menu key to display the following choices:

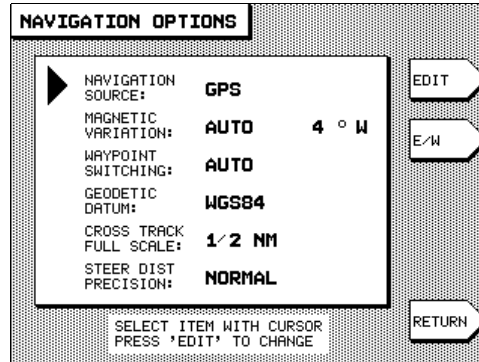

To change any of the displayed options, move the cursor arrow to that item and press the **EDIT** menu key. Use the cursor keys to scroll through available choices, or the keypad to enter specific values.

navigation source (NAVIGATION OPTIONS)

The 941X's position displays and navigation to a waypoint are based on position information obtained from any one of four available navigation sources:

- GPS
- an external loran receiver
- Phantom Loran coordinates calculated from GPS coordinates, or
- "DEMO" mode.



Use the **NAVIGATION SOURCE** option to select which source is to be used. To change it, press the **EDIT** menu key and use the up/down cursor arrow keys to make your selection. Press **ENTER** when you are done, or **CLEAR** to leave the option unchanged.

- **GPS** can be selected as the navigation source at any time.
- **EXTERNAL LORAN** can be used if a loran receiver is interfaced to the 941X (and is operational).
- **PHANTOM LORAN** can be used if no loran receiver is interfaced to the system, but you'd like to see your position displayed in TD coordinates.
- **DEMO** mode is used to simulate a stationary position—namely, the unit's last position fix—if you want to practice using the 941X without being on your boat or connected to an antenna. You may enter a waypoint with the name "DEMO" to establish a new demo position at that waypoint's coordinates.

NOTE

If your 941X is equipped with an internal beacon receiver, differential GPS corrections (if available) will always be used when "GPS" or "Phantom Loran" is selected as the navigation source.

magnetic variation (NAVIGATION OPTIONS)

Compasses naturally point to the *magnetic* north pole, which is several hundred miles from the Earth's actual north pole. The difference between the two angles is known as *magnetic variation*. The 941X offers you the option of choosing from **True** (0°), **Automatic** (the 941X calculates variation automatically, according to your location), and **Manual** (from 0° to 180°, East or West) settings. The factory default is magnetic, to coincide with your compass. Your navigation charts will indicate the approximate magnetic variation for each area.

Under most conditions, you'll want the 941X to calculate the variation *automatically* for your position. (Usually, the automatically-calculated variation is entirely adequate for use.)

True bearings are usually required when using a gyrocompass.

The *manual* setting (1° to 180°) is available for those times when the display must match an older or less accurate chart, or in remote areas (usually above 70° latitude) where magnetic calculations can be off by as much as a degree or more.



Press **EDIT** to change the 941X's magnetic variation setting. Use the up/down cursor keys to choose **AUTO**, **MANUAL** or **TRUE**. When choosing **MANUAL**, move the cursor to the right to enter the value you want. Press **ENTER** when you are done, or **CLEAR** to leave the option unchanged.

waypoint switching (and the arrive radius)

(NAVIGATION OPTIONS)

The 941X can be set to advance automatically to the next waypoint upon arrival at each waypoint, or it can be set to require manual switching.

Manual switching may be desirable when maneuvering around a waypoint to find a lobster trap, or when trying to locate a buoy in dense fog. It allows you to maintain a constant display of distance and bearing information for the particular waypoint you are using, until you instruct the unit otherwise.

When set to automatic switching, the 941X will display new distance and bearing information for the next waypoint upon arrival at the previous one. It will immediately stop navigating when a lone waypoint—or the last waypoint in a route—has been passed.



To change the 941X's mode of waypoint switching, position the arrow to the left of the **WAYPOINT SWITCHING** option and press the **EDIT** menu key. Use the cursor arrow key to select **AUTO** or **MANUAL**. Press **ENTER** when you are done, or **CLEAR** to leave the option unchanged.

You have “arrived” at a waypoint when you enter the circle determined by the waypoint's **ARRIVE RADIUS**, or when you pass the perpendicular of the end point of the current leg you are following. The 941X will signal that you have arrived by flashing the alert symbol (flashing exclamation point) in the lower-right portion of the display. You can either acknowledge the alert by pressing the **STAR** key to display the **ALARMS & BACKLIGHT** screen, then pressing the **CLEAR ALARM** menu key, or you can wait until it automatically clears itself once you have left the arrive circle. (See page 68 for more on the 941X's various alarms.)



The **ARRIVE RADIUS** factory default is 0.02 nautical miles (approx. 120 ft.). To change it:

1. Press the **STAR** key to display the **ALARMS & BACKLIGHT** screen.
2. Move the cursor arrow down to **ARRIVE RADIUS** and press the **EDIT ALARM** menu key.
3. Enter the new value you want, then press **ENTER**, or **CLEAR** to leave the value unchanged.

geodetic datum **(NAVIGATION OPTIONS)**

The geodetic datum option contains all referenced datums according to Defense Mapping Agency publications.



To change the datum reference your 941X is using, press the **EDIT** menu key at this option and use the up/down cursor keys to scroll through the alphabetic listing. When your choice is displayed, press **ENTER**. (The complete listing of 941X datums is found at the end of this chapter, beginning on page 94.)

cross track full scale **(NAVIGATION OPTIONS)**

The **STEERING** screen cross-track display limits may be adjusted to suit your needs, whether you are navigating in open waters or attempting to maneuver through a tight channel.

Adjustments to the display limits (shown at the bottom of the screen) enable you to monitor your progress in increments of feet or meters, if you wish, as opposed to the normal settings of tenths of miles, tenths of nautical miles or kilometers.

The format available to you depends on the selection made in the **DISTANCE/SPEED UNITS** setting under the **DISPLAY OPTIONS** screen. The corresponding choices are:

DISPLAY OPTIONS SETTING	CROSS-TRACK OPTIONS
MI / MPH	1000 FT, 2000 FT, ½ MILE
NM / KNOTS	1000 FT, 2000 FT, ½ N. MILE
KM / KPH	200 Meters, 1KM, 2KM

NOTE
The CROSS-TRACK FULL SCALE display formats apply only to the STEERING screen, and not to the 3-D steer screen.

The options represent the entire distance limit on your screen, from complete left to complete right. Therefore, a cross-track distance setting of 1,000 feet will display 500 feet to either side of your track line, while a choice of ½ mile will display limits of ¼ mile to either side, and so forth.



To change the setting, press the **EDIT** menu key and use the up/down cursor keys to scroll through the available choices. Press **ENTER** when you are done, or **CLEAR** to leave the option unchanged. If necessary, modify the **DISPLAY OPTION** setting to enable your choice of either feet or meters in the cross-track display.

steer dist precision

(NAVIGATION OPTIONS)

The **STEER DIST PRECISION** function offers an extra level of accuracy to the distance-to-waypoint display on the **STEERING** and **3-D STEER** screens. Situated in the upper-left portion of the screens, the distance-to-waypoint is normally displayed in tenths of miles or kilometers.

By changing the **STEER DIST PRECISION** option from **NORMAL** to **HIGH**, the distance-to-waypoint display will increment in feet or meters, once you have come within 1.0 mile or kilometer of the destination waypoint.

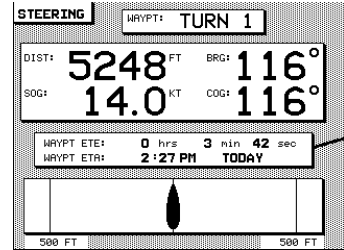
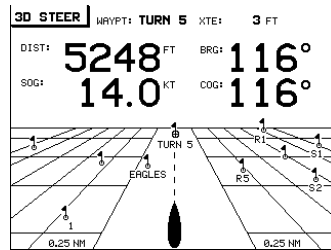



To change the **STEER DIST PRECISION** option, press the **EDIT** menu key and use the up/down cursor keys to scroll among the choices of **HIGH** or **NORMAL**. Press **ENTER** when you are done, or **CLEAR** to leave the option unchanged.

Both steering information screens will now reflect your preference when you are less than one mile or kilometer from your destination.

Receiver Options

The 941X's **RECEIVER OPTIONS** provide you with advanced control capability over several of the unit's GPS and DGPS navigation functions.

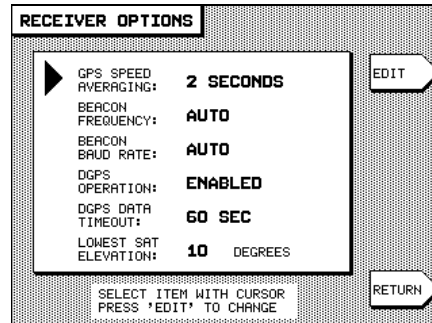

GPS speed averaging When not using Differential GPS, you may notice that Speed-Over-Ground readings obtained from the GPS satellite system are slightly erratic, varying by up to several knots. The 941X's **SPEED AVERAGING** function can often improve the steadiness of these readings, at the expense of a slightly longer display reaction time when the speed changes.

The time over which your speed is averaged by the 941X may be selected with this function, with values between two and ten seconds available. Averaging may also be turned **OFF** completely for the quickest possible reaction time.

A longer averaging time is useful at lower speeds, where the highest accuracy is required, such as when you want to trawl at a certain optimum speed. You will see a slower-changing, more steady display of your speed, with a high degree of accuracy. Shorter averaging times, however, will give you a quicker-changing display of your speed, but with less accuracy.



To change the speed averaging value:

1. Move the cursor arrow in front of the **GPS SPEED AVERAGING** option and press the **EDIT** menu key.
2. Use the up/down cursor keys to select an averaging time of two to 10 seconds—or **OFF**.
3. Press **ENTER** to make the change, or **CLEAR** to leave the value at its previous setting.

You may change the speed averaging value at any time without affecting other 941X navigation functions.

**beacon
frequency/
beacon baud
rate**

(RECEIVER OPTIONS)

If your 941X either contains an internal beacon receiver or is interfaced to an external Northstar beacon receiver, you can set the 941X to control the beacon receiver automatically or control it manually yourself. Under automatic control, the receiver scans for nearby beacon transmitters and uses the one having the best signal for your area. It finds the beacon frequency and data transfer (baud) rate, then receives data fully automatically.

If you prefer, you can set the beacon frequency and baud rate manually to tune in a particular beacon transmitter. (Refer to the “manual mode” operation of the internal beacon receiver on page 75.) For normal operation, it is recommended that these controls be set to AUTO.

The beacon frequency can be set to any value between 283.5kHz and 325kHz. The baud rate should be set to **AUTO**, but can be manually set, if necessary, to any of the four standard rates: 25bps, 50bps, 100 bps or 200 bps.

dgps operation

(RECEIVER OPTIONS)

This option allows you to enable or disable use of differential corrections while navigating in areas where no DGPS signals are available (several hundred miles from the nearest transmitter, for instance). When set to **DISABLED**, the 941X ignores the use of DGPS signals, whether they are from an internal or external source. For normal operation, it is recommended that this setting be left at the factory default of **ENABLED**.

GPS data timeout (RECEIVER OPTIONS)

This setting determines how long the 941X will continue to use existing DGPS corrections if no new corrections are being received (due to bad weather, extreme distance from beacon, etc.). If this time period elapses with no new DGPS data received, the 941X reverts to standard GPS navigation, and displays **OLD CORRECTIONS** as the DGPS status.

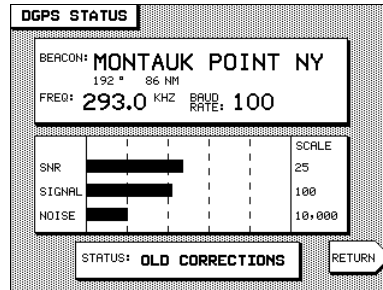

Under normal operating conditions, this “time-out” should be set to one or two minutes to guarantee the highest accuracy. In poor weather conditions, this value can be increased to a maximum of five minutes to ignore occasional outages in the beacon reception (if a minor loss of accuracy can be tolerated). The default setting is 60 seconds.



To change the “age of correction” timeout, use the up/down cursor keys to move the arrow at the left of the screen to **DGPS DATA TIMEOUT**:. Press **EDIT**, then use the cursor keys to choose any value from 30 seconds to five minutes, in 30-second increments.

NOTE

A period of 30 seconds is, in many cases, too short and can lead to intermittent problems. Generally, one minute (the default value set at the factory) provides good navigation accuracy, and is best left unchanged.

Press **ENTER** to make your selection, or **CLEAR** to leave it unchanged.



After this “timeout” period elapses with no DGPS data having been received, the 941X will revert to navigating with normal GPS, the DGPS display indicator (shown at left) will be turned off, and the “DGPS lost” alarm will sound, if enabled (see “Alarms,” beginning on page 68). DGPS navigation will resume automatically as soon as valid corrections are received again.

lowest sat elevation (RECEIVER OPTIONS)

NOTE
It is recommended that this option be left at the factory default of 10°.

The **LOWEST SAT ELEVATION** option is used primarily in technical applications where the 941X is tracking all visible satellites, regardless of how low they are situated relative to the horizon. In those instances where high-precision fixes are necessary, the advanced user can modify this option to “hide” any low satellites, thereby preventing their use as sources of GPS position information, and avoiding potential errors.

If needed, this option is adjustable from 0° to 25°, in 5° increments.

Port Setup Options

The 941X allows you to connect (or “interface”) directly with a variety of external devices, such as autopilots, radars, depth sounders, computers, etc.

Connection is made through any of three data transmission “ports” located on the back side of the 941X: two NMEA ports and one RS-232 port. Each is capable of operating independently, thereby giving you the flexibility of driving (or “talking to”) three separate devices simultaneously. The ports are also independently configurable to meet the specifications of most peripheral navigation equipment. This ensures a customized setup for virtually any NMEA 0183-compatible device. Once configured, the 941X will continuously send a stream of data to the device(s).

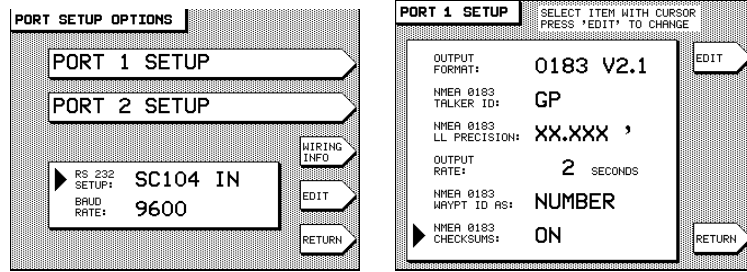

Refer to “Programming the Output Ports,” on page 115, for detailed information on how to interface your 941X with other equipment.

Service Options

To view your 941X’s serial number and hardware specifications, press the STAR key until the USER CUSTOMIZATION screen is displayed. Press the SERVICE INFORMATION menu key to display the following screen:

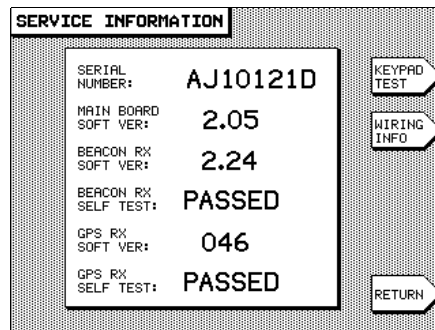

serial number (SERVICE INFORMATION)

In addition to being affixed to the back of the unit, your 941X’s serial number is permanently programmed into memory at the factory. Serial numbers ending with the letter “D” indicate that the unit contains an internal DGPS beacon receiver. Be sure to have your 941X’s serial number and software version available (see below) whenever contacting, or corresponding with, your Northstar dealer or the factory.

**main board
soft ver** (SERVICE INFORMATION)

This number indicates the revision level of your 941X's operating software program.

**beacon rx
soft ver** (SERVICE INFORMATION)

If your 941X has an internal beacon receiver installed, this line will contain a number indicating the software revision of the beacon receiver. If none is installed, the line will be blank.

**beacon rx
self test** (SERVICE INFORMATION)

The 941X automatically self-tests the internal beacon receiver (if installed) each time the unit is powered up. If all test parameters are met, this field will say **PASSED**. If the beacon receiver fails in any of the test criterion, the message **FAILED** will be displayed. In many cases, the cause of the failure is an open or shorted antenna cable, which can be repaired in the field. If this is not the source of the failure, return the 941X to the factory for service.

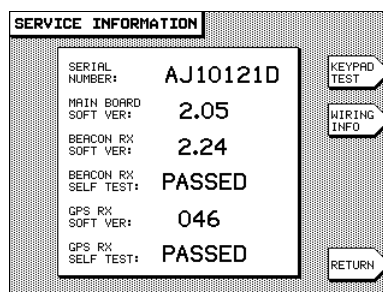

**gps rx soft ver
gps rx self test** (SERVICE INFORMATION)

This displays the software revision being used by your 941X's main GPS receiver. If these lines are blank, the GPS receiver has not been tested recently. Press the **TEST GPS RX** menu key and wait approximately 15 seconds for the test procedure to be completed. Once finished, the receiver's revision number will be displayed, along with the message **PASSED** in the **GPS RX SELF TEST** line at the bottom of the screen. If

the message **FAILED** is displayed, return the 941X to the factory for service.

keypad test (SERVICE INFORMATION)

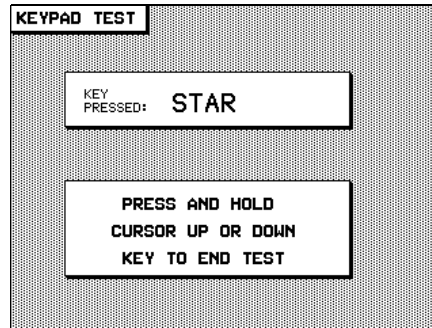

A built-in test feature allows you to verify the integrity of your 941X keypad. Each key you press here will be identified in the **KEY PRESSED** display box. This function works for all but the **POWER**, **CONTRAST** control, and **SAVE/MOB** keys located to the left of the display screen (pressing **SAVE/MOB** during the keypad test will save a waypoint instead of testing the key).

Press and hold the **CURSOR** up or down key until you return to the **SERVICE INFORMATION** screen.

wiring info (SERVICE INFORMATION)

Press this menu key to display a listing of the 941X's interface cable wiring colors and their interface port functions. The wires are also numbered according to their respective positions in the interface connector. A diagram of the connector pins is shown in Figure 11, on page 113. To match the wires with their corresponding pin numbers, refer to Table 2 on page 114.

INTERFACE CABLE WIRING	
BROWN/WHITE	- NMEA 2 IN B
BLUE	- NMEA 1 IN B
WHITE/BROWN	- NMEA 2 IN A
WHITE	- NMEA 2 IN GND
WHITE/BLUE	- NMEA 1 IN GND
BROWN	- NMEA 1 IN A
ORANGE	- NMEA 2 OUT B
BLACK	- NMEA 2 OUT GND
WHITE/ORANGE	- EXT GND, FOIL
BLUE/WHITE	- NMEA 1 OUT GND
GREY	- NMEA 1 OUT B
YELLOW	- NMEA 2 OUT A
PINK	- 200 PPNM OUT
ORANGE/WHITE	- RESERVED
VIOLET	- NMEA 1 OUT A
RED	- RS232 TX
TAN	- RS232 GND
GREEN	- RS232 RX

RETURN

Geodetic Datum

Different regions of the world use various models for lat/lon coordinates on their charts, called “datum.” You should always be sure that your 941X is using the same datum as your charts.



Press the **STAR** key until you display the **USER CUSTOMIZATION** screen, then press the **NAVIGATION OPTIONS** menu key. Move the cursor down to **GEODETIC DATUM** and press **EDIT**. Use the up or down cursor keys to scroll through the list of datums (organized alphabetically, as in the list below). When you come to the datum you desire, press **ENTER**, or press **CLEAR** to leave the datum choice unchanged and exit the edit function.

The following chart lists the datums available in your 941X:

ID	DATUM NAME	ELLIP.S.	delta x	delta y	delta z
ADI_MN	ADINDAN Mean—Africa	CL1880	-166	-15	204
ADI_E	ADINDAN—Ethiopia	CL1880	-165	-11	206
ADI_MA	ADINDAN—Mali	CL1880	-123	-20	220
ADI_SE	ADINDAN—Senegal	CL1880	-128	-18	224
ADI_SU	ADINDAN—Sudan	CL1880	-161	-14	205
AFG	AFGOOYE—Somalia	KRASS	-43	-163	45
AIN	AIN EL ABD 1970—Bahrain Island	INTL	-150	-251	-2
ANA	ANNA 1 ASTRO 1965—Cocos Islands	AUSTR	-491	-22	435
ARC50_MN	ARC 1950 mean value	CL1880	-143	-90	-294
ARC50_B	ARC 1950—Botswana	CL1880	-138	-105	-289
ARC50_L	ARC 1950—Lesotho	CL1880	-125	-108	-295
ARC50_M	ARC 1950—Malawi	CL1880	-161	-73	-317
ARC50_S	ARC 1950—Swaziland	CL1880	-134	-105	-295
ARC50_ZR	ARC 1950—Zaire	CL1880	-169	-19	-278
ARC50_ZM	ARC 1950—Zambia	CL1880	-147	-74	-283
ARC50_ZB	ARC 1950—Zimbabwe	CL1880	-142	-96	-293
ARC60_MN	ARC-1960 mean value	CL1880	-160	-8	-300
ARC60_K	ARC 1960—Kenya	CL1880	-161	-7	-300
ARC60_T	ARC 1960—Tanzania	CL1880	-158	-12	-299
ASC	Ascension Island 1958	INTL	-207	107	52
ABE	Astro Beacon "E" (Pacific Isl.)	INTL	145	75	-272

AB4	Astro B4 Sorol Atoll (Hawaiian Islands)	INTL	114	-116	-333
AD714	Astro Dos 71/4 (Atlantic Isl.)	INTL	-320	550	-494
ASS2	Astronomic Station 1952	INTL	124	-234	-25
AG66	Australian Geodetic 1966	AUSTR	-133	-48	148
AG84	Australian Geodetic 1984	AUSTR	-134	-48	149
BEL	Bellevue (IGN)	INTL	-127	-769	472
BER	Bermuda 1957	CL1866	-73	213	296
BOG	Bogota Observatory (Colombia)	INTL	307	304	-318
CMI	Campo Inchauspe	INTL	-148	136	90
CA66	Canton Astro 1966	INTL	298	-304	-375
CAPE	Cape (South Africa)	CL1880	-136	-108	-292
CC_MN	Cape Canaveral mean value	CL1866	-2	150	181
CARTH	Carthage	CL1880	-263	6	431
CHAT	Chatham 1971 (S.W. Pac. Isl.)	INTL	175	-38	113
CHUA	Chua-Astro	INTL	-134	229	-29
CORR	Corrego-Allegre	INTL	-206	172	-6
DJAK	Djakarta (Batavia)	B1841	-377	681	-50
DOS68	DOS 1968 (S.W. Pac. Isl.)	INTL	230	-199	-752
EI67	Easter Island 1967	INTL	211	147	111
EUR50_MN	European 1950—mean value	INTL	-87	-98	-121
EUR50_WE	European 1950—Western Europe	INTL	-87	-96	-120
EUR50_CY	European 1950—Cyprus	INTL	-104	-101	-140
EUR50_EG	European 1950—Egypt	INTL	-130	-117	-151
EUR50_GB	European 1950—England	INTL	-86	-96	-120
EUR50_GR	European 1950—Greece	INTL	-84	-95	-130
EUR50_IR	European 1950—Iran	INTL	-117	-132	-164
EUR50_SA	European 1950—Sardinia	INTL	-97	-103	-120
EUR50_SI	European 1950—Sicily	INTL	-97	-88	-135
EUR50_NF	European 1950—Norway and Finland	INTL	-87	-95	-120
EUR50_PS	European 1950—Portugal and Spain	INTL	-88	-109	-122
EUR79	European 1979	INTL	-86	-98	-119
GAND	Gandajika Base (Indian Ocean)	INTL	-133	-321	50
GD49	Geodetic Datum 1949	INTL	84	-22	209
GUAM63	Guam 1963	CL1866	-100	-248	259
GUX	Gux 1 Astro	INTL	252	-209	-751
HJOR	Hjorsey 1955—Iceland	INTL	-73	46	-86
HK	Hong Kong 1963	INTL	-156	-271	-189
IND_TV	Indian (Thailand/Vietnam)	EVRST	214	836	303
IND_BIN	Indian (Bangladesh/India/Nepal)	EVRST	289	734	257
IRE65	Ireland 1965	AIRYM	506	-122	611
ISTS	ISTS 073 Astro 1969	INTL	208	-435	-229
JI61	Johnston Island 1961	INTL	191	-77	-204
JAND	Kandawala—Sri Lanka	EVRST	-97	787	86
KERG	Kerguelen Island (Indian Ocean)	INTL	145	-187	103
KERT	Kertau 1948 (Malaysia)	EVRSTM	-11	851	5
KKJ	KKJ (Finnish)	FINN	-78	-231	-97
LC5A	L.C. 5 Astro (Caribbean)	CL1866	42	124	147
LIB64	Liberia 1964	CL1880	-90	40	88
LUZ_P	Luzon—Phillipines	CL1866	-133	-77	-51
LUZ_M	Luzon—Mindanao Island	CL1866	-133	-79	-72
MAHE	Mahe 1971 (Indian Ocean)	CL1880	41	-220	-134
MASI	Marco Astro—Salvage Islands	INTL	-289	-124	60
MASS	Massawa (Africa)	B1841	639	405	60
MERCH	Merchich (Africa)	CL1880	31	146	47
MA61	Midway Astro 1961	INTL	912	-58	1227
MINA	Minna (Africa)	CL1880	-92	-93	122

NAH_O	Nahrwan—Masirah Island (Oman)	CL1880	-247	-148	369
NAH_UA	Nahrwan—United Arab Emirates	CL1880	-249	-156	381
NAH_SA	Nahrwan—Saudi Arabia	CL1880	-231	-196	482
NAP	Naparima BWI (Trinidad and Tobago)	INTL	-2	374	172
NAD27_MN	North American 1927—CONUS mean value	CL1866	-8	160	176
NAD27_WU	North American 1927—Western U.S.	CL1866	-8	159	175
NAD27_EU	North American 1927—Eastern U.S.	CL1866	-9	161	179
NAD27_AK	North American 1927—Alaska	CL1866	-5	135	172
NAD27_BH	North American 1927—Bahamas	CL1866	-4	154	178
NAD27_SS	North American 1927—San Salvador Island	CL1866	1	140	165
NAD27_CN	North American 1927—Canada	CL1866	-10	158	187
NAD27_AB	North American 1927—Alberta and B.C.	CL1866	-7	162	188
NAD27_EC	North American 1927—East Canada	CL1866	-22	160	190
NAD27_MO	North American 1927—Manitoba and Ontario	CL1866	-9	157	184
NAD27_NE	North American 1927—N.W. Terrs. & Sask.	CL1866	4	159	188
NAD27_YK	North American 1927—Yukon	CL1866	-7	139	181
NAD27_CZ	North American 1927—Canal Zone	CL1866	0	125	201
NAD27_CR	North American 1927—Caribbean	CL1866	-7	152	178
NAD27_CA	North American 1927—Central America	CL1866	0	125	194
NAD27_CU	North American 1927—Cuba	CL1866	-9	152	178
NAD27_GR	North American 1927—Greenland	CL1866	11	114	195
NAD27_MX	North American 1927—Mexico	CL1866	-12	130	190
NAD83	North American 1983	GRS80	0	0	0
OBI966	Observatorio 1966 (Atl. Isl.)	INTL	-425	-169	81
OEG	Old Egyptian	HELM	-130	110	-13
OHW_MN	Old Hawaiian—mean value	CL1866	61	-285	-181
OHW_HW	Old Hawaiian—Hawaii	CL1866	89	-279	-183
OHW_KA	Old Hawaiian—Kauai	CL1866	45	-290	-172
OHW_MA	Old Hawaiian—Maui	CL1866	65	-290	-190
OHW_OA	Old Hawaiian—Oahu	CL1866	56	-284	-181
OMAN	Oman	CL1880	-346	-1	224
OSGB_MN	Ordin. Survey of Gr. Britain 1936—mean value	AIRY	375	-111	431
OSGB_E	Ordin. Survey of Great Britain 1936—England	AIRY	371	-112	434
OSGB_IM	Ordin. Survey of G. B. 1936—Isle of Man, Wales	AIRY	371	-111	434
OSGB_SSI	Ord Surv of G.B. 1936—Scot. & Shetlnd Islands	AIRY	384	-111	425
OSGB_WL	Ordinance Survey of Great Britain 1936—Wales	AIRY	370	-108	434
PDLN	Pico De Las Nieves—Canary Islands	INTL	-307	-92	127
PA67	Pitcairn Astrological—1967	INTL	185	165	42
PSC63	Provisional S. Chilean 1963	INTL	16	196	93
PSA56_MN	Provisional S. American 1956—mean value	INTL	-288	175	-376
PSA56_BO	Provisional S. American 1956—Bolivia	INTL	-270	188	-388
PSA56_NC	Provisional S. American 1956—N. Chile	INTL	-270	183	-390
PSA56_SC	Provisional S. American 1956—S. Chile	INTL	-305	243	-442
PSA56_CO	Provisional S. American 1956—Columbia	INTL	-282	169	-371
PSA56_EC	Provisional S. American 1956—Ecuador	INTL	-278	171	-367
PSA56_GY	Provisional S. American 1956—Guyana	INTL	-298	159	-369
PSA56_PR	Provisional S. American 1956—Peru	INTL	-279	175	-379
PSA56_VN	Provisional S. American 1956—Venezuela	INTL	-295	173	-371
PRICO	Puerto Rico	CL1866	11	72	-101
QUAT	Qatar National	INTL	-128	-283	22
QORN	Qornoq (Greenland)	INTL	164	138	-189
REUN	Reunion (Indian Ocean)	INTL	94	-948	-1262
ROME	Rome 1940	INTL	-225	-65	9
SDOS	Santo (DOS) (S.W. Pacific Isl.)	INTL	170	42	84
SBRAZ	Sao Braz (Atl. Isl.)	INTL	-203	141	53
SHILL	Sapper Hill 1943	INTL	-355	16	74
SCHW	Schwarzeck (Namibia)	B1841N	616	97	-251
SA69_MN	South American 1969—mean value	SA1969	-57	1	-41

SA69_AG	South American 1969—Argentina	SA1969	-62	-1	-37
SA69_BO	South American 1969—Bolivia	SA1969	-61	2	-48
SA69_BR	South American 1969—Brazil	SA1969	-60	-2	-41
SA69_CH	South American 1969—Chile	SA1969	-75	-1	-44
SA69_CO	South American 1969—Colombia	SA1969	-44	6	-36
SA69_EC	South American 1969—Ecuador	SA1969	-48	3	-44
SA69_GY	South American 1969—Guyana	SA1969	-53	3	-47
SA69_PA	South American 1969—Paraguay	SA1969	-61	2	-33
SA69_PR	South American 1969—Peru	SA1969	-58	0	-44
SA69_TT	South American 1969—Trinidad and Tobago	SA1969	-45	12	-33
SA69_VZ	South American 1969—Venezuela	SA1969	-45	8	-33
SASIA	South Asia	FS1960M	7	-10	-26
SEBAS	Southeast Base	INTL	-499	-249	314
SWBAS	Southwest Base	INTL	-104	167	-38
TIMB	Timbalai 1948 (Malaysia)	EVRST	-689	691	-46
TOK_MN	Tokyo mean value	B1841	-128	481	664
TOK_JP	Tokyo—Japan	B1841	-123	483	662
TOK_KR	Tokyo—Korea	B1841	-128	481	665
TOK_OK	Tokyo—Okinawa	B1841	-135	478	661
TA68	Tristan Astrological 1968 (S. Atl.)	INTL	-632	438	-609
VL16	Viti Levu 1916 (S.W. Pac. Isl.)	CL1880	51	391	-36
WE60	Wake-Eniwetok 1960	HOUGH	101	52	-39
WGS72	WGS 1972	WGS-72	0	0	4.5
WGS84	WGS 1984	WGS	0	0	0
	Zanderij (S. America)	INTL	-265	120	-358

Table 1—Datum List

9

Installation and Interfacing

Mounting the 941X	100
Wiring the 941X System	102
GPS Antenna Location	104
DGPS Antenna Coupler (ACU)	108
Interfacing the 941X	112
Programming the Output Ports	115
RS-232 Port	126

This section includes all the information needed to install your 941X and interface it to other equipment on your boat.

Mounting the 941X

Proper installation of your Northstar 941X receiver is of utmost importance to accurately receive and effectively use GPS signals under a wide variety of weather conditions. To get the best performance from your Northstar, we strongly recommend that you have an authorized Northstar dealer install it for you. However, if you prefer to perform the installation yourself, please follow these instructions carefully.

The following points should be considered before proceeding with your installation:

- ✓ location of unit
- ✓ electrical power and wiring
- ✓ antenna location and installation
- ✓ grounding the entire system
- ✓ testing and monitoring system performance

It is recommended that the unit be bench tested prior to installation on your boat. This not only insures that the equipment is fully operational, but it allows the GPS receiver to collect its almanac and ephemeris data for the installed location, resulting in less installation time spent on the vessel.

Choose a mounting location for the 941X that allows good visibility of the screen, is within comfortable reach, and provides a reasonably direct path for running the required electrical cabling.

The majority of installation problems are caused by shortcuts taken with system cables. Assemble connectors carefully; don't make sharp bends; leave service and drip loops; tie-wrap the coaxial antenna cable to keep it secure.

941X system components

Your Northstar 941X is shipped complete and ready to install. You will need special tools for assembling the coaxial cable connectors, as indicated on page 105.

The shipping carton contains the following components:

- the 941X
- GPS antenna
- 25' coaxial antenna cable (for passive-patch antennas; 50' supplied with optional active-patch antenna)
- beacon receiver Antenna Coupling Unit (ACU) (for units with internal differential GPS receiver only)
- 10' interface cable
- 10' power cable
- flush-mount drilling template
- sunshield
- this Reference Manual
- connectors and parts kit

Save all packing material in the event it is necessary to return the unit to the factory for repair or evaluation. Your 941X should only be shipped in a properly designed carton with packing material.

placement of the 941X

The 941X houses the GPS receiver, optional beacon receiver, computer, power supply, lights, controls and the specially-coated display screen. The mounting location should be chosen carefully before any drilling or cutting takes place. Be sure you have easy access to the control panel's keys and can clearly see the display from your normal vantage point when navigating your boat. Even though the display screen contains an effective anti-reflective coating, choose a location where glare from windows or other bright objects will be minimized. Refer to the dimensions in Figure 13 for planning your installation.

Whether you're flush-mounting or yoke-mounting the unit, allow at least 2½" clearance at the rear for cables and connectors. For yoke-mounts, leave ample room (usually 2") all around the sides and top to avoid crowding the unit. (See Figure 2 for yoke-mount drilling requirements.)

Though the unit itself is waterproof, the connectors at the back of the unit are not impervious to corrosion from saltwater spray. Protect your Northstar investment from prolonged exposure to the elements by mounting it in a relatively dry area, if possible. At the end of the day,

wipe the unit dry, especially the rear connectors. When not in use, cover the 941X with the sunshield to protect it from excessive heat.

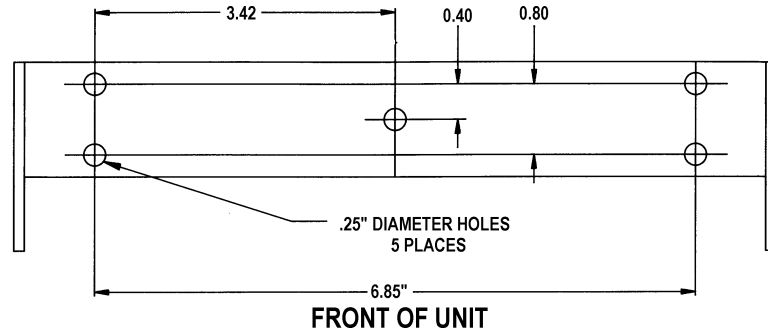

Figure 2—Yoke Mount Drilling Dimensions

Wiring the 941X System

Your Northstar is designed with an internal fusible link to protect against faulty power wiring. The link consists of a short length of 30 AWG wire located on the I/O board. If this link becomes open-circuited, carefully check all power wiring, especially the white and black wires on the power cable.

Replacement of the fusible link should be performed only by a qualified electronics technician. Access to the link is gained by removing the 10 outer case screws to open the 941X, then removing the 4 computer board screws and lifting the computer board out to expose the I/O board below. The link should be replaced with another short length of 30-gauge wire.

electrical power requirements

The 941X is a negative-ground system that is reverse-polarity protected: an internal fuse prevents damage to sensitive components.

The 10-foot power cable wires must be connected as follows:

- Red → Positive (+) 10–40VDC
- Black → Negative (–)
- White → Ground
- negative ground only
- 14-gauge connecting wire (recommended for runs of 15 feet or more)
- 16-gauge minimum allowed for runs up to 15 feet

We strongly recommend (as a good safety practice) that your 941X be connected to an external circuit breaker or fuse located near the battery or breaker box. The internal fuse is designed to protect the 941X itself; the external fuse or breaker is intended to protect the vessel wiring and prevent electrical fires. The power wiring should be connected directly to the battery when possible for optimum noise immunity.

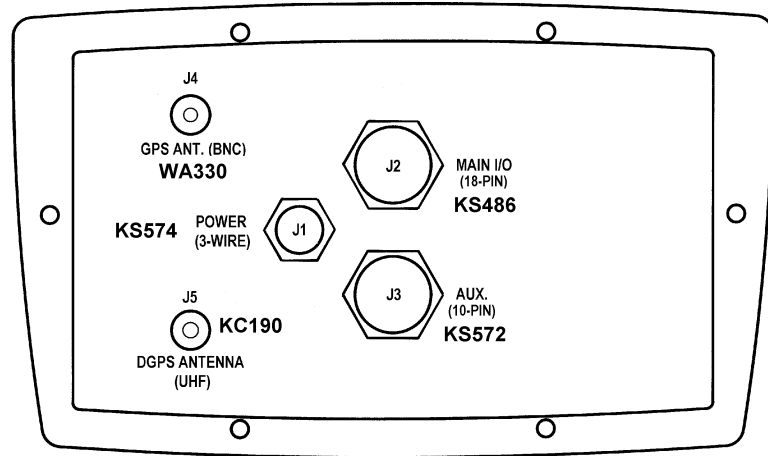

- J1 Power Connector (3 wire)
- J2 Main I/O Interface Connector (18-wire)
- J3 Auxiliary (future expansion—10 wire)
- J4 GPS Antenna Connector (BNC)
- J5 DGPS Antenna Connector (UHF)

Figure 3—Rear Connectors

power wiring The 941X should be connected to a source of 10- to 40-volt electrical power, using at least 16-gauge wire. A 10-foot power cable is supplied with your unit, and should be sufficiently long for most installations. If it is necessary, however, to lengthen the power cable, you may extend it to a maximum of 25 feet without adversely affecting the operation of the unit.

Antenna Location

Three antennas choices are available for your 941X: two for reception of GPS-only signals (standard #AN145 and “active” #AN150), and one to receive both GPS and DGPS signals (#AN190 combo antenna).

The antenna is a vital link between the 941X receiver and the outside world. Aesthetics and easy access should be secondary to providing strong and reliable GPS signals to the 941X receiver. You should select a location for the antenna which meets the following requirements:

- ✓ The antenna should have a reasonably clear view of the horizon, but be no higher than necessary (side-to-side motion of the antenna caused by rolling of the vessel may degrade your SOG and COG readings);
- ✓ The antenna must be out of the radiation plane of any on-board radar sets;
- ✓ The antenna must be lower than any INMARSAT communications antenna;
- ✓ The antenna should be as far as possible from other high-power transmitting antennas;
- ✓ Watch out for electromagnetic “shading” of antennas from rigging, other vessels, shoreline buildings, etc. Secure the cable well (the center conductor is solid wire).

gps-only antenna location

Whereas a loran antenna should be mounted high on the vessel for best performance, the GPS-only antenna should be mounted as low as possible and out in the open to avoid “shading” (placement of the antenna where it is partially obscured by another object from the signals it must receive). Don’t mount the antenna on top of a tower or mast. Often the bow or stern will provide a location where shading is minimized, while serving to keep the antenna low. Be sure that any directional L-band transmitting antennas (such as radar or satellite communication antennas) can never point at the GPS antenna—its preamplifier is quickly destroyed by such radiation.

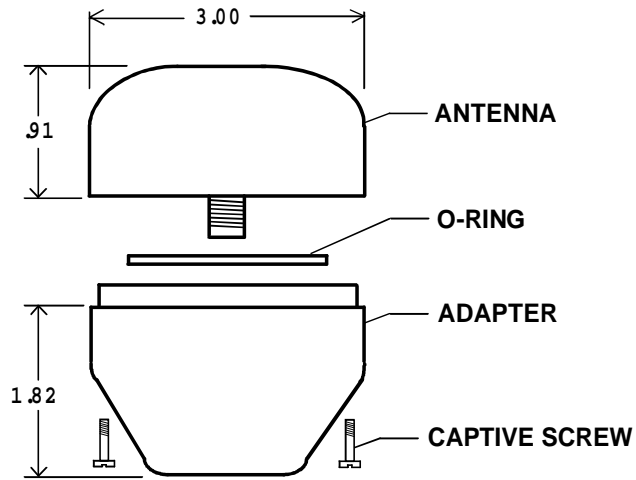

Figure 4—941X GPS-Only Antenna (AN145 & AN150)

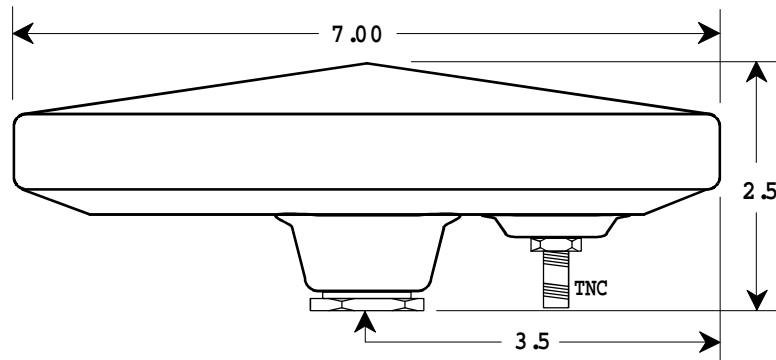

Figure 5—941X Combo GPS/DGPS Antenna (AN190)

**mounting the
GPS-only
antenna**

- Tools needed:
- 1) flat-bladed screwdriver
 - 2) knife blade
 - 3) Amphenol crimp tools.

The RG-59 cable supplied with your 941X has one TNC connector attached to the antenna-end of the coax. Connection to the antenna itself involves the following steps:

1. Remove the antenna base by loosening the four captive screws in the base.
2. Screw the base onto the top of the antenna mount (standard 1"-14 marine thread).
3. Feed the open end of the supplied coax cable down through the antenna base and through the hollow core of the antenna mount.
4. Affix the TNC connector-end of the coax to the mating connector inside the upper half of the GPS antenna.
5. Align the upper half of the antenna with the bottom half and tighten the four screws. Be careful not to over-tighten the screws, as this may deform the watertight seal between the two antenna halves.

antenna wiring

Supplied with your antenna is a length of RG-59 coaxial cable (25 feet with #AN145 passive antenna, and 50 feet with the optional #AN150 active and #AN190 combo antennas).

Cable length for the GPS-only passive antenna must not exceed 25 feet. If a longer cable run is necessary, use either the Northstar “active” or “combo” antenna for minimum lengths of 50 feet, up to a maximum of 100 feet. (Runs between 25 and 50 feet require either the active or combo antenna and the minimum 50-foot length of cable. The extra footage may be coiled up, but not removed.)

combo GPS/DGPS antenna

For applications with grounding problems, or where optimum portability is required, or when only a single antenna is desired, a combination GPS/DGPS antenna is available, part #AN190 (see Figure 5 on page 105). This “combo” antenna provides for an easier and better-looking installation. In many cases, the loop antenna design improves the noise rejection of signals interfering with differential signals. However, like the “active” GPS antenna, the combo antenna must be used with a minimum of 50, and no more than 100, feet. Any unused length must be coiled up; do not cut it to less than 50 feet!

The cable “splitter” box supplied with the AN190 combo antenna should be located near the 941X for convenience, but may be situated virtually anywhere along the length of the maximum 100 feet of RG-59 GPS cable,

without appreciable signal loss. However, the splitter is not weatherproof and should be placed in a protected area where it will not be subjected to direct water splash or spray.

combo antenna location

The combo antenna should be located where it has a clear view of the horizon, but is not the highest point on the vessel. Keep the antenna at least six feet away from objects that can “shade” GPS or differential signals.

GPS antenna cables

Avoid tight bends when installing any antenna cable. Be sure to fasten the cable along its length to avoid chafing or whipping of any kind.

After the antenna has been mounted and the cable has been cut to length, install the supplied BNC connector at the other end (refer to Figures 6, 7 and 8 on pages 107 and 108). A satisfactory crimp for this connector may be made with a commonly available, high-quality crimping tool designed for use with BNC connectors.

Be sure the BNC connector is properly installed—most system failures, whether continuous or intermittent, can be traced to poor connector installation.

- 1) Strip cable jacket to the following dimensions (in inches), as illustrated in Figure 6: $a=0.57$, $b=0.34$, $c=0.14$, $d=0.43$. Do not nick the center conductor.

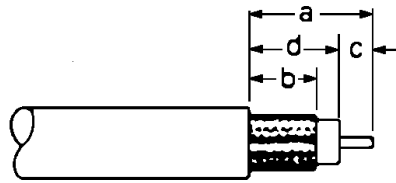

Figure 6—Stripping the Coax Cable Jacket

- 2) **Figure 7:** Slide outer ferrule on as shown. Slightly flare the end of cable braid, as shown, to facilitate insertion into inner ferrule.



Figure 7—Flared Cable Braid

3) Place center contact onto center conductor so that it butts against the cable dielectric. Crimp the contact in place using Amphenol tool handle #227-944 and Cavity B of Die Set 227-980-3.

4) **Figure 8:** Install cable assembly into body assembly so inner ferrule slides over dielectric and under braid. Push cable assembly forward until contact seats in insulator. Slide outer ferrule over braid and up against connector body. Crimp outer ferrule using Cavity A of tools specified above.

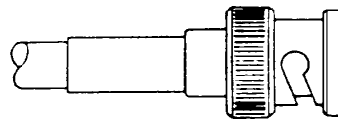

Figure 8—Completed BNC Connector

If poor GPS SNR readings are obtained after the 941X has been running for several minutes, check that you have the proper length of cable matched to the type of antenna (active, passive, or combo), verify the quality of the antenna location, and the quality of the connectors.

DGPS Antenna Coupler (ACU)

The Northstar 8410 Antenna Coupling Unit (ACU) supplied with the Differential GPS-equipped 941X must be used in all differential GPS antenna installations, except in cases where the AN190 Combo GPS/DGPS antenna is used. Though similar in appearance to other Northstar ACUs, only the one labeled “8410” will work with your internal DGPS beacon receiver. The ACU also serves as a sturdy mounting base for the DGPS whip antenna.

The ACU consists of two pieces. The circuitry is sealed in a rugged, waterproof, fiberglass polycarbonate body, the upper end of which is threaded to accept a standard 4-foot whip antenna. A large female thread

is molded into the lower portion, or base, of the ACU body into which the upper half is secured (see Figure 9 on page 110). The bottom of the base is threaded (1"-14) to mount onto the antenna mast or onto a standard deck mount. A gasket and rubber O-ring provide weathertight sealing at the ACU base.

The ACU connects to the receiver by a single 25-foot length of RG-58U coaxial cable which carries signals to the beacon receiver and DC power to the ACU amplifier. The cable passes up through the hollow ACU base and connects to the PL-259 (UHF) connector at the bottom of the ACU (see Figure 10 on page 111 for UHF connector preparation). Note: This connection must be made before the ACU is screwed into its base.

grounding

The grounding system is an equal partner with the antenna in producing quality signals for the 941X DGPS beacon receiver. Essentially, the ground system provides a secure connection to a large electrical mass; ideally, the earth itself. On a vessel, this means establishing electrical contact with the sea. On a steel vessel, a good connection to the hull or steel pilothouse is sufficient. Wood or fiberglass vessels require a metal ground plate. If the metal ground plate is impractical, the engine block or the negative (-) battery terminal can sometimes be used, but only as a second choice.

Lack of proper grounding can adversely affect beacon signal strength, as well as SNRs, and is the most common source of problems with beacon antenna installations. The 8410 ACU has a separate black ground wire inside the coupler base. This wire is the AC signal ground connection from the antenna input circuit. The purpose of bringing it out is to make available a separate signal ground path.

Other electrical equipment onboard can cause large amounts of electrical noise, even at points that appear well-grounded. Try several ground points (ground plate, vessel ground, engine block, etc.) to determine which works best under different conditions.

Assembling the ACU

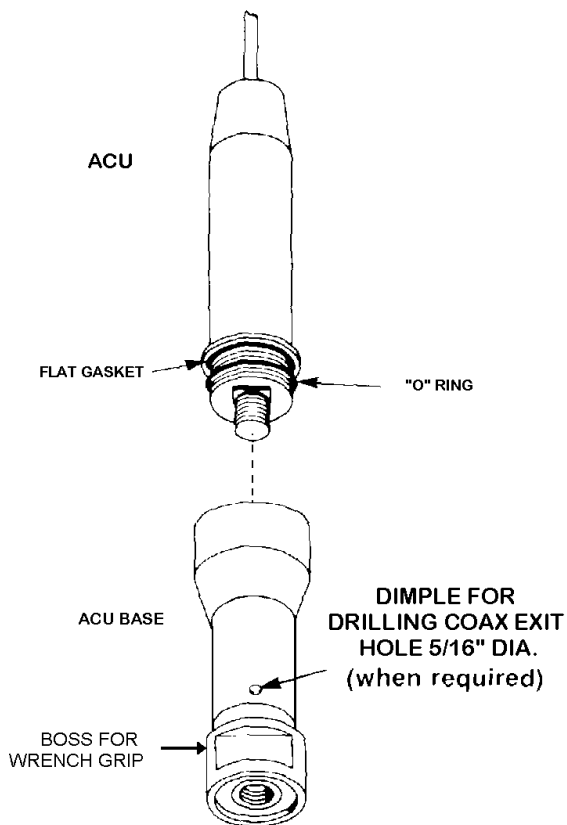

ANTENNA COUPLING UNIT (ACU)

Figure 9—ACU Assembly

WARNING

WHENEVER ANY ANTENNA IS DISCONNECTED FROM ON-BOARD EQUIPMENT, BE SURE TO GROUND THE ANTENNA SHIELD IN ORDER TO DISCHARGE EXTREMELY LARGE STATIC VOLTAGES THAT CAN QUICKLY BUILD UP ON AN UNGROUNDED ANTENNA SYSTEM. THESE VOLTAGES ARE HAZARDOUS TO PERSONNEL AND EQUIPMENT!

**differential GPS
antenna cable
connectors**

Both ends of the differential beacon receiver antenna cable terminate in UHF connectors. Follow the assembly instructions in Figure 10 for preparing UHF connectors. For best results, coat these connectors with silicone gel to retard corrosion.

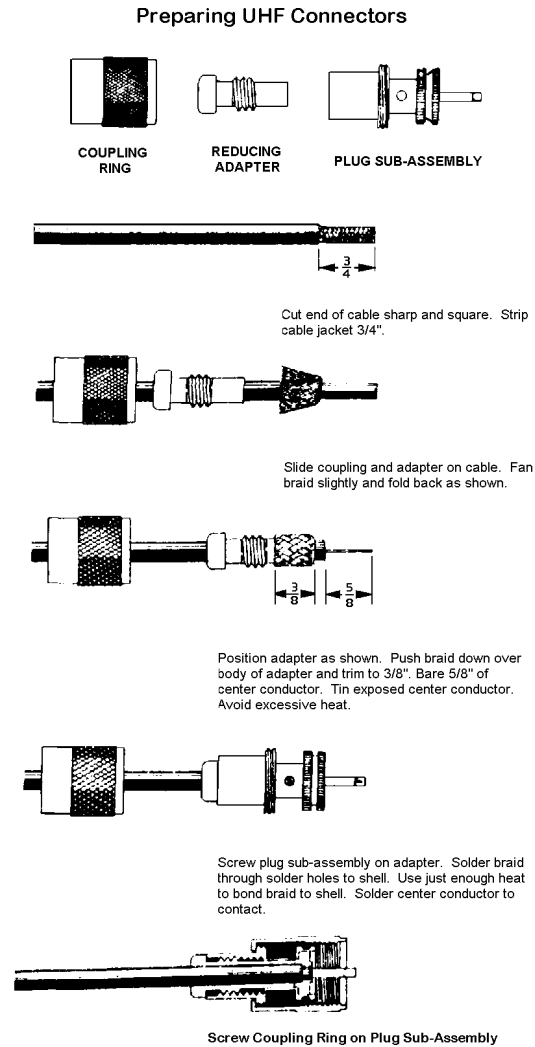

Figure 10—PL 259 (UHF) Connector

DGPS antenna mounting

The Northstar 8410 differential beacon receiver antenna should be mounted as high as conveniently possible (but not at the highest point) and as far away as possible from other antennas. If you have several possible antenna locations, you may evaluate each by operating the 941X with the DGPS antenna temporarily mounted in each location. The best location is one providing the lowest “NOISE” count (atmospheric impulse noise generated by thunderstorms and other conditions) and highest Signal-to-Noise Ratio (SNR). Both values may be viewed using the **DGPS STATUS** information screen accessed from the main **GPS POSITION** screen, as seen on page 26.)

Another major concern, precipitation static (called “P-static”), must be addressed when installing the antenna. P-static generally appears only during rain or snow; consequently, it can be easily overlooked during installation.

Much like a loran antenna, the effects of P-static are minimized if the beacon antenna is mounted so that it is not the highest metallic object on the vessel. The highest metal object acts much like a lightning rod, attracting tiny static discharges in the atmosphere. If the beacon receiver antenna is the highest object, these discharges can totally override the beacon signals and cause poor operation in bad weather. The optimum antenna location is high and clear for fair-weather operation, but below the top of a metal mast or other antenna for best foul-weather operation. On sailing vessels, the ACU might be mounted on top of a low mast, or on the stern rail if no other suitable location is available.

The 8410 beacon ACU can be mounted on a standard marine antenna mount (one inch diameter, 14 threads per inch).

Interfacing the 941X

The 941X is easily interfaced to other equipment as described below. NMEA 0183 is the most common interface data format used with 941X installations. It is a widely-accepted standard of data transfer between most all types of marine electronics today, enabling completely different instruments to “speak” a common language.

The 941X has two programmable NMEA input/output ports and one RS-232 input/output port that you can customize for outputting data to other instruments, and two ports for inputting data from other devices.

connector pin wiring (PORT SETUP OPTIONS)

A list of wire connections for the interface connector is built-into the 941X's PORT SETUP OPTIONS screen, accessed from the USER CUSTOMIZATION menu. Press the WIRING INFO menu key to display the following screen:

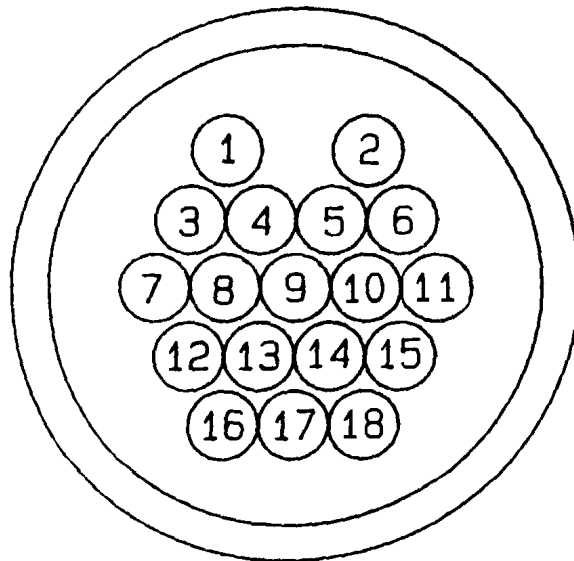
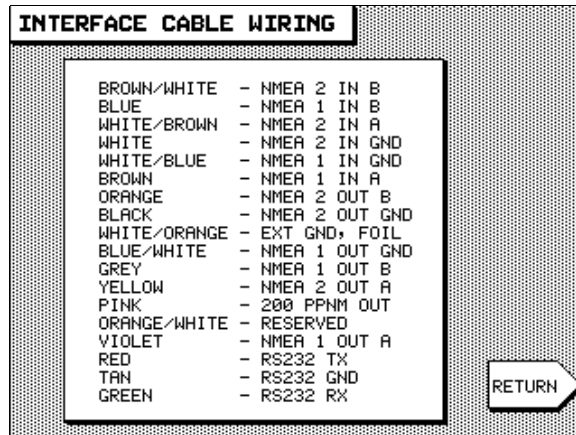

Figure 11—Interface Connector (mating side)

Description	Wire Color	Pin
NMEA PORT 1 INPUT A	BROWN	3
NMEA PORT 1 INPUT B	BLUE	1
NMEA PORT 1 INPUT GROUND	WHITE w/BLUE STRIPE	4
NMEA PORT 1 OUTPUT A	VIOLET	12
NMEA PORT 1 OUTPUT B	GRAY	7
NMEA PORT 1 OUTPUT GND	BLUE w/WHITE STRIPE	8
NMEA PORT 2 INPUT A	WHITE w/BROWN STRIPE	6
NMEA PORT 2 INPUT B	BROWN w/WHITE STRIPE	2
NMEA PORT 2 INPUT GROUND	WHITE	5
NMEA PORT 2 OUTPUT A	YELLOW	15
NMEA PORT 2 OUTPUT B	ORANGE	11
NMEA PORT 2 OUTPUT GND	BLACK	10
RS-232 GROUND	TAN	17
RS-232 INPUT	GREEN	16
RS-232 OUTPUT	RED	18
EXT. GND / FOIL DRAIN	WHITE/ORANGE & SHIELD	9
EXTERNAL SAVE IN	ORANGE w/WHITE STRIPE	13
200 PPNM OUT (Pulses Per Nautical Mile)	PINK	14

Table 2—Interface Connector Pins

200 ppm output

The Northstar 941X provides an open-collector transistor output (on pin 14) which is programmed to produce 200 pulses per nautical mile for those devices requiring this output.

The emitter of the NPN transistor is connected to ground, and the collector connects to the output pin side (see block diagram in Figure 12 on page 115). The output can sink 100mA and can withstand a maximum positive voltage of 50 volts.

If the output connects to a highly inductive device, such as a relay, a spike suppression diode should be connected across the load. Cathode connects to the power side of the device and anode connects to the output pin side.

The output produces a negative pulse 80ms wide and supports speeds from zero to 100 knots (clamps at 100kt).

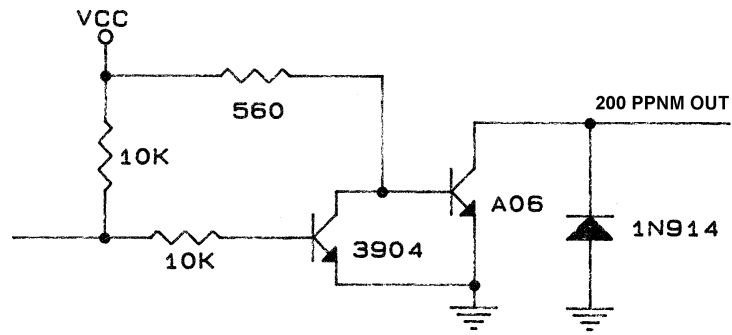
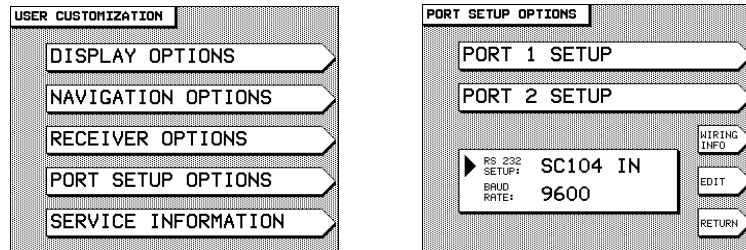

Figure 12—200 PPNM Output Block Diagram

Programming the Output Ports

Each output port can be programmed to meet most any special requirements of devices that conform to the NMEA 0183 data format specification. The **SETUP** function described below allows the selection of the specific 0183 sentences that will be transmitted by the 941X.

Press the **STAR** key until you see the **USER CUSTOMIZATION** menu. Press the menu key marked **PORT SETUP OPTIONS**, then press the **PORT 1 SETUP** or **PORT 2 SETUP** key.



A list of data format control options is displayed:

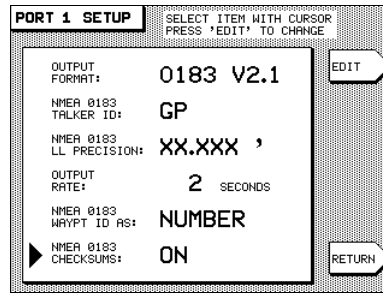

Check the installation instructions for the equipment to which you are interfacing for any special requirements. The Northstar factory settings will be adequate for most peripheral equipment, but the following options are available, if needed:

PARAMETER	OPTIONS
OUTPUT FORMAT: (see below)	choose NMEA 0180, NMEA 0183, DATAM CDX, RAY 0183 or NONE
NMEA 0183 Talker ID: (see page 120)	choose GP, LC, or I I, to make the 941X look like a GPS receiver, Loran-C receiver, or an "integrated instrument"
NMEA 0183 lat/lon precision: (see page 121)	choose hundredths of minutes, thousandths of minutes, or ten-thousandths of minutes
OUTPUT RATE: (see page 122)	choose 2 to 999 seconds for the interval at which data is sent to the external device
NMEA 0183 waypoint ID as: (see page 122)	choose NAME or NUMBER for the identifier of waypoints sent to the external device
NMEA 0183 checksums: (see page 122)	choose ON or OFF for compatibility with some older devices

Table 3—Port Setup Options

output format (PORT 1 / PORT 2 SETUP)

The 941X will output navigation data in any of several standard formats (or one user-customizable sequence), as required by the receiving, or "listener" device. Upon pressing the EDIT menu key at this option, then the up/down cursor arrows, you'll find the following choices available to you: NMEA 0180, 0183 V2.1, DATAMARINE CDX, 0183 RAY, and NONE. Designate the required format and press ENTER.

(NMEA) **0180** is an infrequently-used format, developed in the late 1970's and is required by many older autopilots.

0183 V2.1 is the most popular interfacing format and is used by most autopilots, radars, plotters and other equipment.

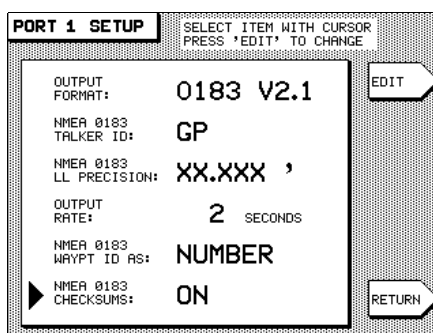

After pressing **ENTER** to select 0183 as the output format, you will be presented with a list of all 0183 sentences which may be individually turned on or off.

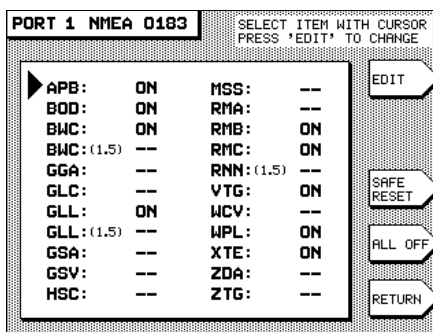

The 1.5 sentences (BWC, GLL, and RNN) enable the 941X to be backward-compatible with marine equipment previously designed for this earlier version of 0183. Details for using the 0183 format are given in the following section, "NMEA 0183 and RAY 0183 sentences," on page 118

DATAMARINE CDX is required by Datamarine's cross-track error indicators, the latest of which display distance and bearing to your waypoint.

0183 RAY is used when transmitting/receiving position information to/from Raytheon equipment. It uses Raytheon's non-standard NMEA 0183 checksum, where, on output, the checksum is not included, and on

input to the 941X, the checksum is ignored. (It should be noted that, with the checksum ignored on input, there is a possibility of the 941X receiving contaminated NMEA data when it is connected to an external Raytheon Ioran.) Format is supported on **PORT 1** and **PORT 2**.

The setting **NONE** is used when the 941X is not connected to an external device.

NMEA 0183 and RAY 0183 sentences

(PORT 1 / PORT 2 SETUP)

NMEA 0183 is perhaps the most widely-accepted standard of data transfer used in marine electronics devices today. It enables GPS and Ioran navigators, for instance, to “talk” to plotters, radars, charting instruments and other electronics by means of a common “language.”



When either NMEA 0183 or RAY 0183 is selected as the output format (after pressing the **EDIT** menu key) and **ENTER** is pressed, a screen is displayed showing all of the available NMEA 0183 sentences that will be output by the 941X.

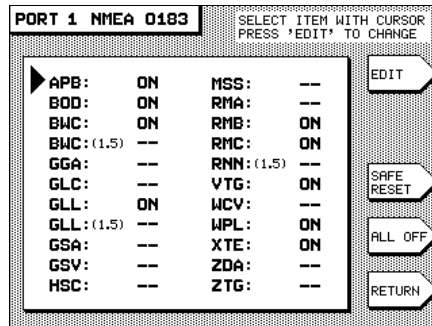

Some devices cannot handle all of these sentences, so you may use this screen to customize the output by turning individual sentences ON or OFF. In general, you might want to turn ON only those sentences used by the particular equipment to which you are interfacing the 941X. (See Table 4 on the next page for a listing of NMEA 0183 sentence identifier meanings.)



To modify the 941X’s NMEA 0183 sentence output format, follow the above steps to display the 0183 sentences. Three-letter abbreviations identify each sentence and are listed alphabetically. The sentences that

will be output are followed by the word ON. Those that will not be output are followed by two dashes, signifying that they are turned OFF.

1. Move the cursor arrow to the sentence you wish to change and press the **EDIT** menu key.
2. Use the up/down cursor keys to toggle the sentence ON or off (dashes) and press **ENTER** to make your selection, or **CLEAR** to leave it unchanged.
3. Repeat for each sentence requiring modification. Press the **RETURN** menu key to go back to the **PORT SETUP** screen when you are done.

If you wish to set all sentences to the factory defaults for recommended output, press the **SAFE RESET** menu key.

The **ALL OFF** menu key enables you to conveniently turn off all sentences in the event you wish to then turn on only a select few for output.

The meaning of the NMEA 0183 three-letter identifiers are:

0183 IDENTIFIER	MEANING
APB	Autopilot Sentence "B"
BOD	Bearing to Destination
BWC	Bearing & Distance to Wpt. (Great Circle)
GGA	GPS Fix Data
GLC	Geographic Position, Loran-C
GLL	Latitude/Longitude
GSA	GPS DOP and Active Satellites
GSV	GPS Satellites In View
HSC	Heading Steering Command
RMA	Recommended Min. Sentence A
RMB	Recommended Min. Sentence B
RMC	Recom. Min. Specific GPS/Transit Data
RNN	Navigation Route
VTG	SOG/COG
WCV	Waypoint Closure Velocity (SOA)
WPL	Waypoint Location
XTE	Cross-track Error
ZDA	Estimated Time of Arrival
ZTG	Time-To-Go

Table 4—NMEA 0183 Sentence Identifiers

NMEA 0183 (PORT 1 / PORT 2 SETUP) talker ID

Part of the NMEA 0183 standard requires that the equipment you are interfaced to—the “listener”—know what type of device is transmitting the data. The talker ID tells the listener that it is receiving information from a navigation source (the 941X) and not a communications or sensor device, which transmit completely different—and therefore unusable—forms of data.

The “talker ID” enables you to configure the 941X’s output data to tell the listener it is receiving data from a loran (LC) or GPS (GP) navigator, or Integrated Instrumentation (II). The choice you make depends on what

the listener device is expecting. Check the listener device's instruction manual to determine which "talker ID" codes it will respond to.

Use the EDIT menu key, then scroll through the three choices using the up/down cursor arrow keys to make your choice. Press ENTER when done.

The interfaced equipment will then receive the 0183 data in the correct nav-source format.

NMEA 0183 (PORT 1 / PORT 2 SETUP) lat/lon precision

For added versatility in communicating with a variety of other devices, you can control the level of precision of the 0183 position information as it's output by the 941X.

Using the EDIT menu key and the up/down cursor keys, you'll see the display change from:

- XX.XX ' (lat/lon precision to two decimal places / hundredths of minutes / or 60 feet) to
- XX.XXX ' (three decimal places / thousandths of minutes / or 6 feet), to
- XX.XXXX ' (four decimal places / ten-thousands of minutes / or roughly ½ foot).

The factory default is .XXX (thousandths of minutes).

NOTE

Precision output to three or four decimal places does not mean that your 941X navigates with such accuracy, unless it is using DGPS. Position information can be output and displayed to four decimal places, but your actual ability to navigate to such a precise point is limited by the accuracy of the Loran and GPS systems (see "Comparing GPS and Loran," on page 5). Therefore, specifying more decimal places in the data output does not result in greater navigating accuracy.

The choice you make is dependent upon the equipment to which you are outputting NMEA data. The 941X conforms to the NMEA version 2.10 standard, but is also compatible with version 1.50. Equipment typically benefiting the most from three and four decimal places of precision are electronic and pen plotting devices. However, most all older devices designed to operate with the original 0183, and other formats, can only

function with two-place precision. Refer to the manufacturer's instructions for how many digits of precision are required for that particular device.

output rate (PORT 1 / PORT 2 SETUP)

The 941X defaults to a two-second update interval for data transmission. There are some applications where a longer update period is required, and the 941X allows you to increase that span to 999 seconds.

NMEA 0183 waypoint ID as (PORT 1 / PORT 2 SETUP)

Many new marine electronic devices (such as radars and electronic plotters) can display your waypoint names, if they are output by the 941X.

If your peripheral equipment has this capability, change the **WAYPOINT ID AS** field from **NUMBER** to **NAME**, using the **EDIT** menu key, then the up/down cursor arrow keys. Press **ENTER**. The listening device will now display your six-character waypoint names.

NOTE

*Be sure to verify this capability in the listening device **before** changing the **WAYPOINT ID AS** field. Most older equipment won't understand this identifier, and using it may cause problems with the display of your waypoint information.*

nmea 0183 checksums

Certain older devices may not accept sentences containing the NMEA 0183 checksum that is output by the 941X. In such cases, the device may not operate properly, if at all.

If you encounter difficulty when interfacing to older equipment, the 941X offers you the flexibility of turning off the NMEA 0183 checksum. Move the cursor to **NMEA 0183 CHECKSUMS**, press the **EDIT** menu key, and use the up or down cursor key to change the setting from **ON** to **OFF**. Press **ENTER**, then **RETURN** when you are done.

**connecting to a
Northstar 800
series loran**

If you presently own a Northstar 800 series loran, you may connect it to your 941X to serve as an ideal source of Loran-C TDs and previously-stored waypoint locations. Use the appropriate pin/wire connections and the 800's setup sequence, each listed below, to initialize the data output to be received by the 941X. Port 1 or Port 2 of the 941X, or A or B of the 800, may be used. Wire colors refer to the 941X's interface cable.

800 OUTPUT		⇨ CONNECT TO EITHER ⇩
PORT A	941X PORT 1	941X PORT 2
Pin 12	brown (#3)	white w/brown stripe (#6)
Pin N	blue (#1)	brown w/white stripe (#2)

Table 5—Connection to Northstar 800 Port A

800 OUTPUT		⇨ CONNECT TO EITHER ⇩
PORT B	941X PORT 1	941X PORT 2
Pin 7	brown (#3)	white w/brown stripe (#6)
Pin H	blue (#1)	brown w/white stripe (#2)

Table 6—Connection to Northstar 800 Port B



To configure the 800 for correct output format, execute COMMAND 83 for output port A, or COMMAND 84 for output port B. Press the lower SELECT button until PRINTER 3 appears in the lower display, and press ENT. Then enter the following sequence to program the output parameters:

AT THIS PROMPT	PRESS	TO OUTPUT THIS DATA TO 941X
SET UP	149 (ENT)	0183 output format (8 bits, no parity, 4800 baud)
INTERVAL	1 (ENT)	1 second output rate
ITEM 1	13 (ENT)	include GTD sentence in output (Loran-C TDs)
ITEM 2	26 (ENT)	waypoint location*
ITEM 3	31 (ENT)	include SRS sentence in output (status of received signals)
ITEM 4	40 (ENT)	include RMA sentence in output
ITEM 5	0 (ENT)	end of sequence

Table 7—Northstar 800 Series Output Port Setup

* Only used if you want the waypoint to which you are navigating to be automatically transferred to the 941X's waypoint database.

connecting to other devices

Interfacing to other devices requires slightly different pin/wire connections. For example, use the following table to enable the 941X to communicate with a Yeoman electronic chart plotter.

↗ **CONNECT TO EITHER** ↘

YEOMAN WIRES	941X PORT 1	941X PORT 2
NMEA OUT (white) (DATA A+)	NMEA IN (brown #3)	white w/brown stripe (#6)
Data Return (green) (GROUND)	white w/blue stripe (#4)	white (#5)
NMEA IN (red) (DATA +)	NMEA OUT (violet#12)	yellow (#15)
RETURN (black) (GROUND)	blue w/white stripe (#8)	black (#10)

Table 8—Yeoman Electronic Plotter Setup with 941X

connecting to an external source of differential corrections

If your 941X is not equipped with an internal beacon receiver, you can interface it with an external Northstar model 8800, 8401 or 8400 beacon receiver, or other source of differential corrections. As described on page 74, differential corrections greatly enhance the accuracy of GPS by improving your position fixes to accuracy of 2-5 meters in most cases.

To take advantage of this extra level of precision, connect the Northstar beacon receiver to the 941X's **RS-232** port as follows:

8800 DGPS Sensor	941X Interface Connector
Pin 21 (receive)	red (RS-232 output) #18
Pin 20 (transmit)	green (RS-232 input) #16
Pin 17 (ground)	tan (RS-232 ground) #17
8400 beacon receiver	941X Interface Connector
black (receive)	red (RS-232 output) #18
white (transmit)	green (RS-232 input) #16
orange (ground)	tan (RS-232 ground) #17
8401 beacon receiver	941X Interface Connector
yellow (receive)	red (RS-232 output) #18
blue (transmit)	green (RS-232 input) #16
orange (ground)	tan (RS-232 ground) #17

Table 9—Connecting to External NS Beacon Receiver

(For connection to other sources of differential corrections, refer to the manufacturer's instructions for wiring information.)



Now you're ready to set up the 941X to receive the data from the external source, using the RS-232 interface port. Press the **STAR** key until you display the **USER CUSTOMIZATION SCREEN**. Press the **PORT SETUP OPTIONS** menu key. The following screen will be displayed (information displayed by your 941X in the **RS-232 SETUP** box at this time may be different):

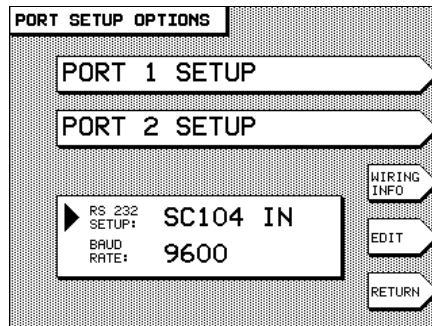

In order to receive SC-104 corrections through the 941X's RS-232 interface port, the port information box in the lower center of the screen must read: **SC-104 IN**. If the port is presently set up for anything other than **SC-104 IN**, press **EDIT** to change this setting. Use the up or down cursor arrow keys to display **SC-104 IN** and press **ENTER**.

Use this same **EDIT** procedure to set the baud rate to match that of the external device, if necessary. (Refer to the external device's instructions for correct baud rate setting.) The 941X is now configured to accept differential corrections from an outside source.

RS-232 Port

The RS-232 port is used for interfacing to an external DGPS beacon receiver, an external device that accepts SC-104 differential corrections, or a personal computer.

When connected to a beacon receiver, you can receive differential corrections through the RS-232 port. This is useful if your 941X is not equipped with an internal beacon receiver, but you want to navigate using differential corrections.

If your 941X features an internal Northstar beacon receiver, you can use the RS-232 port to transmit its differential corrections to another device that accepts them.

If you wish to download your waypoints to a personal computer, or to have the unit upgraded by your dealer or the factory with new operating software, you can connect to a PC using the RS-232 port.

Following are descriptions of the RS-232 port's various settings:

- SC-104 out** SC-104 OUT outputs differential corrections from your 941X's internal beacon receiver to an external device that accepts the standard SC-104 data stream. When using SC-104 OUT, be sure that the **BAUD RATE** setting also matches the baud rate requirements of the receiving device.
- SC-104 in** SC-104 IN accepts differential corrections from any external source transmitting the standard SC-104 data stream. Use this setting if your 941X is not equipped with an internal DGPS beacon receiver and you wish to receive differential corrections from an external source. When using SC-104 IN, be sure that the **BAUD RATE** setting also matches the baud rate of the transmitting device.

NOTE
*Switching to **SC-104 IN** enables the 941X to receive DGPS corrections from an external source and **disables** the internal DGPS beacon receiver (if installed).*

copy port 1
copy port 2

The COPY PORT function enables you to interface the 941X to many Personal Computers without the need for an RS-422-to-RS-232 converter. Many PC application programs for waypoint/route loading, chart programs, data logging, etc. can be used. The function “copies” the output of the specified port 1 or port 2 data format (NMEA 0180, NMEA 0183, DATAMARINE CDX, or RAYTHEON 0183) to the RS-232 port’s output for direct connection to your computer.

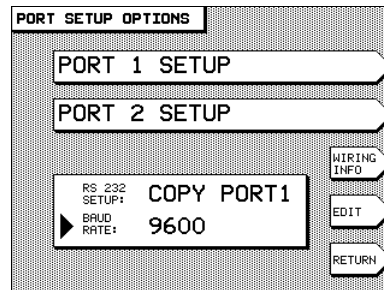

1. At the PORT SETUP OPTIONS screen, confirm that the port you wish to copy is presently set up to output the data format you wish to use by pressing the PORT 1 SETUP or PORT 2 SETUP menu key. If necessary, make changes now, using the EDIT menu key, and press ENTER, then RETURN when you are done to return to the PORT SETUP OPTIONS screen.
2. Change the RS-232 SETUP option (if necessary) to display the appropriate COPY PORT 1 or COPY PORT 2 selection by pressing the EDIT menu key and using the up/down cursor arrow keys to change the selection. Press ENTER when you are finished, or CLEAR to leave the RS-232 port setup unchanged.

The 941X will now copy and output the specified port’s data format through the RS-232 port to an external device.

diagnostic

The RS-232 port’s DIAGNOSTIC option is for future factory service diagnosis of 941X operating parameters.

port off

Use this setting when the RS-232 port’s input or output functions are not needed.

Northstar 941X Specifications

System Features

Position Data

- Latitude/longitude (158 datums) from GPS with 1-second updates
- Phantom Loran-C TDs (calculated from GPS) Loran-C TDs (from your existing loran: 1 second from Northstar 800 series, 2 seconds from other lorans)
- Real-time receiver status screens

Steering Screens

- Large, easy-to-read graphical presentation
- Waypoint name, position
- Bearing and distance to waypoint
- Cross-track error (numeric and two graphic screens: traditional and 3-dimensional)
- Heading correction
- Speed Over Ground
- Course Over Ground
- Time-to-go
- Estimated Time of arrival
- Estimated Time Enroute
- Speed of advance
- Automatic magnetic variation

NavLog

- Arrival time for waypoints passed
- ETA for all waypoints not yet passed in trip
- ETA for total trip
- Reverse the trip
- Add waypoints to end of trip
- Distance and bearing for all legs
- Skip forward and back in trip

Waypoint & Route Management

- Avoidance Waypoints
- Enter wpts as lat/lon, distance and bearing, or loran TDs
- Displays 30 closest waypoints
- Store 1,000 waypoints
- Store up to 500 routes
- Stores waypoints/route
- Update waypoint coordinates to ship's position
- Edit/erase waypoints or routes
- Plan Route function
- Plot any route with automatic chart scale selection
- Time-To-Go

Waypoint Navigation

- Navigate to coordinates, waypoints and along routes
- Save current position
- Steer to new point function (go to any waypoint or coordinates at any time)
- Waypoint queuing
- Follow stored routes forward or backward
- Plot current route with other local data

Plotter Functions

- Plotter shows track history, nearby wpts, avoidance areas
- Speed Over Ground
- Course Over Ground

Miscellaneous Functions:

- Anchor watch
- Avoidance Area Alarm
- GPS clock
- TideTrack
- Tide data by Marisystems, Inc.

GPS Receiver

- **Type:** LI Frequency, C/A code (SPS), 12-channel, continuous tracking
- **Sensitivity:** C/N₀ >34 dB-Hz
- **Navigation Accuracy:**
- 3m 2DRMS with Differential
- 100m 2DRMS without Differential (S/A on)
- Navigation update rate: 1 per second

- Time To First Fix: 30 seconds (typical)
- Dynamics: Velocity: 1800 km/h
- Acceleration: 4m/sec; Jerk: 2m/sec²
- **Operating Modes:** 2D Nav, 3 or more satellites; 3D Nav, 4 or more satellites visible
- SC-104: Processes all USCG SC-104 message types, including 1 and 9
- EMI: FCC Part 15 subpart J

Interfaces

- Two bi-directional NMEA I/O ports
- One bi-directional RS-232 port
- Waypoint upload/download capability
- Operating software upload
- NMEA output sentences: APB, BOD, BWC, BWC (1.5), GGA, GLC, GLL, GLL (1.5), GSA, GSV, HSC, RMA, RMB, RMC, RNN (1.5), VTG, WCV, WPL, XTE, ZDA, ZTG (conforms to NMEA v. 2.1)
- NMEA input sentences: WPL and others
- Accepts external differential corrections
- Accepts external loran receiver

Physical Features

- Dimensions: 10.8" W x 6.5" H x 3.3" D
- Slim "mount anywhere" waterproof unit
- 320 x 240 pixel high-temperature, backlit, transfective graphics LCD
- Large (5.75") easy-to-read screen
- High-contrast screen with anti-reflection coating to minimize glare
- Audio beeper for alarms and confirmation of actions
- Large, easy-to-use backlit controls
- Easy removal for secure storage
- Internal Beacon Receiver for differential corrections (optional)
- Power: 10–40 VDC; 12 watts with internal Beacon Receiver
- Operating temperature: 0°C–55°C max.; 95% relative humidity, non-condensing

Dimensions

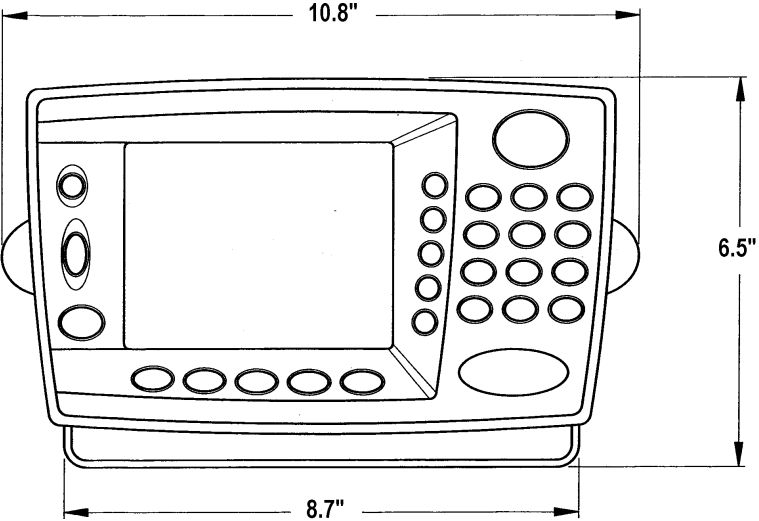
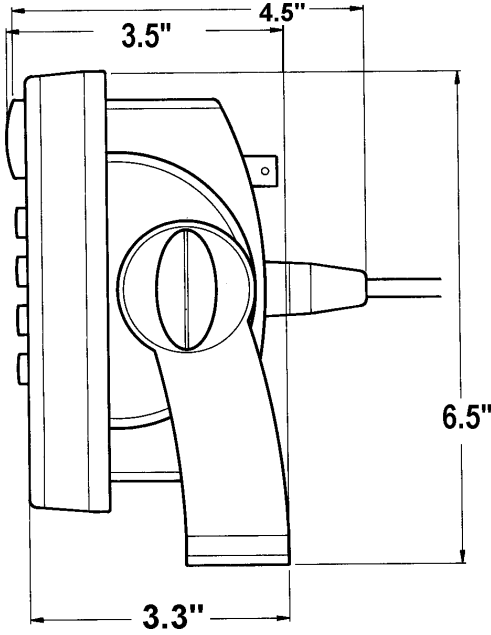

Figure 13—941X Dimensions

Internal Beacon Receiver (optional)

Signal Processing

- Number of Channels: 2
- Frequency Range: 283.5–325.0 kHz
- Tuning Resolution: < 2 Hz
- Minimum Signal Strength: 1 μ V/m @ 100bps
- Dynamic Range > 100 dB
- Adjacent Channel Rejection: > 50 dB at 1 kHz
- Acquisition Time: 5 seconds, manual command
- 15 seconds, automatic warm start
- 15 minutes, automatic cold start *
- Noise Blanker: Predictive variable length
- Signal Detection: Acquisition via FLL (frequency-locked loop); tracking via PLL (phase-locked loop)

Data Processing

Demodulation: MSK (Minimum Shift Keying)
Data Decoding: Parallel-matched digital filters
MSK Bit Rates: 25, 50, 100, 200 (automatically selected)

Power Requirements

Power Consumption: 2 Watts

Data Ports

DGPS Correction Output Port:
RTCM SC-104 Version 2.0–6 of 8
RS-232-C
9600 or 4800 baud

Environmental

Whip Antenna:
ACU: Height: 11 inches
Diameter: 2.6 inches
Weight: 1.5 pounds
Antenna: 48-inch fiberglass whip (not supplied)
(Shakespeare 4' #173 loaded, or Radio Shack #21-934)

**Combo GPS /
DGPS Antenna**

- Frequency: 1575 MHz ±2 MHz
- Finish: Outdoor Weatherable Polymer
- Polarization: Right-Hand Circular
- Weight: 22 Ounces
- Axial Ration 3 dB Max.
- Altitude: 12,000 Feet
- Noise Figure: 2.5 dB Max.
- Temperature: -40° C to +70° C
- Impedance: 50 Ohm
- VSWR: <2.0 : 1
- Band Rejection 35dB @ 1625 MHz
- Power Handling: 1 Watt

IEC Compliance

Immunity to electromagnetic environment (1988/92 amend.):

Evaluation	Standard
Radiated emissions	IEC 945 (1995) per 17.3, 17.4
Low temperature	IEC945 (1995) per 4.5.4.2.4
Dry heat	IEC 945 (1995) per 4.5.2
Damp heat	IEC 945 (1995) per 4.5.3
Corrosion	IEC 945 (1995) per 4.5.10
Vibration	IEC 945 (1995) per 4.5.7
Rain test	IEC 529-IPX 5

GLOSSARY

accuracy: *absolute accuracy*—the accuracy of displayed lat/long coordinates of your present position as compared to lat/long determined from a chart or other reference source.

repeatable accuracy—the ability to return to the same location using a receiver's previously-obtained coordinates.

acquisition: The procedure during which a GPS receiver attempts to track satellites before a position fix can be computed.

almanac: Data describing the precise orbits of GPS satellites, obtained automatically from satellite signals and stored in a GPS receiver. The receiver requires about 15 minutes to collect almanac data the first time it is turned on. Thereafter, it can usually use the almanac data collected previously.

chain: A group of loran transmitters comprised of a master station and at least two secondaries.

coverage: The extent to which a geographical area is encompassed by usable GPS or loran signals.

cursor: The display panel indicator that shows which character or character field is ready to be changed, acknowledged, or entered by the user. It is activated and positioned by the user when required. The 941X's cursor will appear as an arrow or a flashing block, depending on whether you are choosing or entering data.

ephemeris: Data used to calculate exact satellite positions, continually updated and derived from information relayed to the 941X in each satellite's data stream.

ETA: Estimated Time of Arrival at the next waypoint, as calculated by the 941X according to your present speed of advance (SOA) and distance to the waypoint.

ETE: Estimated Time Enroute to the next waypoint, as calculated by the 941X according to your present speed of advance (SOA) and distance to the waypoint.

GPS: Global Positioning System. A navigation system using signals from earth-orbiting satellites. The system is capable of providing high accuracy under all weather conditions.

great circle: Shortest possible path between two points on the surface of a sphere.

GRI: Group Repetition Interval. The characteristic identifying period of signals emitted by each loran transmitting chain. The identifier 9960 (Northeast US) indicates that the gap between the start of any two adjacent master signals is 99,600 microseconds long.

interference: The electromagnetic interruption of a radio signal causing poor signal reception. Interference may originate from external sources (such as other radio transmitters) or from the vessel itself (such as alternator noise or precipitation static).

latitude: Imaginary lines on the earth's surface running East/West and expressed in degrees (0-90) north or south of the Equator. Used in conjunction with the North/South lines of longitude to determine position.

leg: The path between adjacent waypoints of a route.

longitude: Imaginary lines on the Earth's surface running North/South and expressed in degrees (0-180) east or west of the Prime Meridian (a line running from the North to South Pole, passing through Greenwich, England).

Loran-C: Acronym for LOnG RAnge Navigation. System of land-based radio transmitters emitting precisely-timed pulses which are received and translated into position "fixes."

magnetic variation: The difference between magnetic North and true North. Since the difference varies according to geographic location, the Northstar 941X automatically calculates magnetic varia

tion and uses it to display bearings as magnetic north. The variation at any location changes slowly over a period of years, and the 941X compensates, according to the current calendar year.

master: The one loran transmitter in a “chain” of at least three stations which initiates the series of coded pulses emulated by the secondaries.

precipitation static: Also known as “P-Static.” Precipitation-induced electrical charge which can build up on antenna surfaces, resulting in poor radio reception.

readout: The panel of graphic images and alphanumeric characters used by the 941X to display navigation data.

SNR: Signal to Noise Ratio. Guide number for determining the relative quality of GPS, DGPS, or loran signals as compared to background radio “noise.”

TD: Time Difference. The measured amount of time—in millionths of a second—between loran signals received from the master and the secondary stations.

track: A desired line of travel.

waypoint: A particular location (defined for navigation purposes by its lat/lon, distance and bearing, or TDs), used as an intermediate or final destination.

INDEX

A

absolute accuracy.....	See accuracy, absolute
ACCURACY	
repeatable.....	135
ACCURACY	
absolute	5, 135
absolute, GPS.....	6, 8, 9
absolute, loran	8
Coast Guard requirement.....	6
DGPS	2, 4, 7, 9, 26, 27, 34, 74, 75
from waypoints entered as TDs.....	9
GPS.....	2, 5, 9, 28, 75
GPS speed	87
repeatable.....	6
repeatable, loran	7, 8, 9
updating waypoints	42
ACQUIRE indicator.....	2
ACU.....	101, 108, 109, 110, 112, 133
ALARMS	
anchor drag.....	40, 70
arrive radius	40, 71, 85
avoidance areas.....	40
cross track	40, 70
listing of types.....	68
AN145 antenna.....	106
AN150 antenna.....	106
AN190 combo antenna	106
ANTENNA	
DGPS	103, 108, 111, 112
GPS.....	9, 101, 103, 104, 106, 107
arrive radius.....	40, 71, 84
asterisk.....	49
avoidance areas	4, 5, 10, 22, 23, 39, 40, 42, 43, 46

B

beacon receiver	9, 30, 83, 88, 101, 108–12, 124
BNC connector	107
brightness.....	5, 10

C

chart	23, 26, 42, 94
checksums	117, 122
CLEAR ALARM menu key.....	3

COG	22, 23, 104
contrast	14
COPY PORT function	127
cross-track display limits	85
cursor (flashing)	17, 30, 36, 135

D

data timeout	30, 68, 71, 76, 89
Datamarine	116, 127
datum	26, 85, 94
DGPS	
antenna	103, 108, 111, 112
checking status	34
data timeout	30, 68, 71, 76, 89
DIAGNOSTIC port function	127
differential corrections	2, 6, 9, 26, 34
DISPLAY OPTIONS	78
distance and bearing	38, 42, 47, 54, 56, 61, 65, 66
distance and speed units	79
drilling	101

E

ephemeris	30, 100
exclamation point (flashing)	2, 18, 39, 68, 69, 84

F

first start-up	2, 3
flashing cursor	17, 30, 36, 135
flashing exclamation point	2, 18, 39, 68, 69, 84
function keys	5, 16

G

GO TO menu key	55
GPS	
absolute accuracy	5, 6, 8, 9
accuracy	2, 28, 75, 121
and DGPS	6, 34, 82, 83, 108, 124
antenna	9, 101, 103, 104, 106, 107

checking status	32, 34
comparing to Loran	5, 7
converting coordinates from Loran TDs	42
converting coordinates to Loran TDs.....	9, 32
converting coordinates to Phantom Loran.....	16, 82
displaying lat/lon	25
interfacing with Loran	9, 10, 22, 30
receiver software revision.....	92
satellite status	27, 34
selecting as navigation source	32, 34, 82
with DGPS	7
with Selective Availability	6, 7, 8
GRI.....	31, 34, 54
grounding	100, 109

H

HDOP	28
------------	----

I

I.D. message	81
INFORMATION windows	19
input ports.....	11, 113, 114, 118, 125, 127
INTERFACING	
compatibility	112, 116, 120, 124
connector pin diagram.....	113
general.....	11, 112
port setup.....	90, 124
rear connectors layout.....	103
to external beacon receiver	88, 124
to loran.....	5, 9, 16, 22, 30, 31, 83
to Northstar 800 loran	31, 123
wiring info.....	93, 113

K

keypad.....	17, 18, 36, 74, 75
keypad test.....	93

L

latitude and longitude display adjust	80
---	----

LORAN	
absolute accuracy	8
comparing to GPS.....	5
converting TDs to lat/lon	42
displaying TDs	5, 9, 10, 16, 22, 30, 31
interfacing with GPS	30, 31
Phantom operation.....	32, 33
repeatable accuracy.....	7
selecting as navigation source	30
lowest sat elevation function	90

M

magnetic variation	83
man overboard	5, 15
manual waypoint switching	84
maximum saved waypoint number.....	80, 81
MOB	See man overboard

N

NAV LOG key.....	17, 65, 66
NAVIGATION OPTIONS	82
NMEA 0183	9, 31, 90, 112, 115–22
noise.....	103, 109, 112
Northstar 800.....	31, 32, 123

O

output ports	11, 90, 93, 113, 115, 133
owner identification message.....	81

P

parts list.....	101
personal computer.....	37, 44
Phantom Loran.....	5, 16, 32, 33, 34, 82
plotter	4, 8, 10, 16, 22, 24, 25, 47
PORT SETUP OPTIONS	
wiring info screen.....	113
PORT SETUP OPTIONS	
connecting to Northstar 800.....	123

overview.....	90
programming the ports.....	115, 125
RS-232 port	126
POSITION key.....	16, 22
P-static	112

Q

QUESTION windows	18, 19, 49, 81
QUICK PLOT.....	47, 52
QUICK waypoint	54

R

RECEIVER OPTIONS	87
recent alarms.....	3
repeatable accuracy	See accuracy, repeatable
ROUTES	
changing	46, 50, 51
creating.....	44-49
following.....	51
plotting.....	4, 22, 47, 52
saving as you travel	47, 48, 49
RS-232	11, 115, 125, 126, 133

S

SA	See Selective Availability
SATELLITE	
acquiring	3
comprising GPS system.....	6-8
LOWEST SAT ELEVATION option	90
status.....	27, 30, 34
SAVE/MOB.....	5, 15, 41, 42
SC-104 DGPS corrections.....	2, 11, 125, 126, 133
Selective Availability	6, 7, 27
serial number.....	91
SERVICE INFORMATION.....	91
SKY SEARCH indicator.....	2
SNR.....	29, 32, 112
SOFTWARE VERSION	
941X main board.....	92
beacon receiver	92
GPS receiver	92

SOG	22, 23
STAR key	5, 16, 30, 33, 68, 76, 82
STEER key	16, 55
steering distance precision	86
STOP SAVE function.....	49

T

TDs.....	5, 9, 16, 31, 32, 33, 34, 38, 54, 123
tide	4, 5, 10, 16, 71, 72, 73, 74
TideTrack	10, 68, 71
TIME	
changing time zone	78
DGPS acquisition.....	133
DGPS data timeout.....	76
DGPS data timeout.....	68, 71, 89
of arrival (ETA).....	5, 57, 60, 64, 65
of day.....	5, 16, 25, 78, 80
of sunrise and sunset.....	16, 78
of tide levels.....	72
speed averaging	87
to waypoint (ETE)	5, 57, 60, 64
TNC connector	105, 106
track history	5, 16, 22, 25

U

user customization screen	78
---------------------------------	----

W

warning radius	39, 43
WAYPOINTS	
arrive radius	84
as avoidance areas	23, 39
changing	39, 42, 43, 54
converting GPS coordinates to TDs	9
creating.....	16, 37, 44, 46
displaying.....	4, 17, 24, 50
displaying as TDs.....	9
entering coordinates.....	37–39, 54
entering name and description	37
inserting in a route	44–46, 50, 51
lists	41, 46
plotting.....	5, 10, 16, 22, 39
Quick Start.....	54

removing from a route	51
saved as you travel	42, 49
saving as part of a route.....	44, 49
switching to next (auto)	84
switching to next (manually)	84
transferring to a personal computer.....	44
updating coordinates.....	42, 43
verifying entry.....	47
WAYPTS/ROUTES key.....	5, 16, 37, 43, 44, 54, 59
wiring (installation).....	102
wiring information screen	93

Z

zoom	10, 23, 47, 61
------------	----------------