

EURO-PRO

DOUBLE BASKET DEEP FRYER

OWNER'S MANUAL

Model K4320

120V., 60Hz., 1700 Watts



EURO-PRO Operating LLC

Boston, MA, 02465

1 (800) 798-7398

www.euro-pro.com

IMPORTANT SAFETY INSTRUCTIONS

When using electrical appliances, basic safety precautions should always be followed, including the following:

1. Read all instructions for use carefully and look at the illustrations before you start using the appliance.
2. Do not touch hot surfaces, always use handles or knobs.
3. To protect against electrical shock, do not immerse cord and plug of this appliance in water or other liquids.
4. Close supervision is necessary when any appliance is used by or near children.
5. **Unplug from outlet (not from receptacle on appliance)** when not in use and before cleaning. Allow to cool before putting on or taking off parts and before cleaning the appliance.
6. Do not operate any appliance with a damaged cord or plug, or after the appliance malfunctions, has been dropped or damaged in any manner. Return the appliance to **EURO-PRO Operating LLC** for examination, repair or adjustment. See warranty.
7. Never plug in before the control panel is installed in the body of the fryer and the heating element is placed in the oil reservoir.
8. Never overfill the fryer with oil. Fill only between the minimum and maximum levels, as indicated inside the oil reservoir.
9. Be sure handle is properly assembled to the basket and locked in place. See detailed assembly instructions.
10. The use of accessory attachments not recommended by the appliance manufacturer may cause injuries.
11. Always insert heating element in the appliance first, then plug into the wall outlet. To disconnect, remove plug from wall outlet then wait for the unit to cool completely before removing the heating element.
12. Extreme caution must be used when moving any appliance containing hot oil or other hot liquids.
13. Do not leave appliance unattended while in use.
14. Do not use outdoors.
15. Do not let cord hang over the edge of the table, counter or touch hot surfaces.
16. Do not place on or near a hot gas or electric burner, or in a heated oven.
17. Do not use appliance for other than intended household use.
18. Ensure that basket handle is correctly assembled and locked in place. (See assembly instructions.)

SPECIAL SAFETY INSTRUCTIONS

- A short power supply cord is provided to reduce the risk resulting from becoming entangled in or tripping over a longer cord. An extension cord (or longer detachable cord) is not recommended for use with deep fryers.
- Never plug in the control panel before it is installed in the body of the fryer with the heating element inside the oil container.
- Do not immerse the control panel and heating element in water.
- When opening the lid after frying, first release the lid by pushing the latch with your finger, then wait a moment to allow the steam inside to escape before opening fully.
- To avoid a circuit overload, do not operate another high wattage appliance on the same circuit.

This appliance has a polarized plug (one blade is wider than the other). To reduce the risk of electric shock, this plug is intended to fit into a polarized outlet only one way. If the plug does not fit fully into the outlet, reverse the plug. If it still does not fit, contact a qualified electrician. Do not attempt to modify the plug in any way.

**SAVE THESE INSTRUCTIONS
FOR HOUSEHOLD USE ONLY**

GETTING TO KNOW YOUR DEEP FRYER

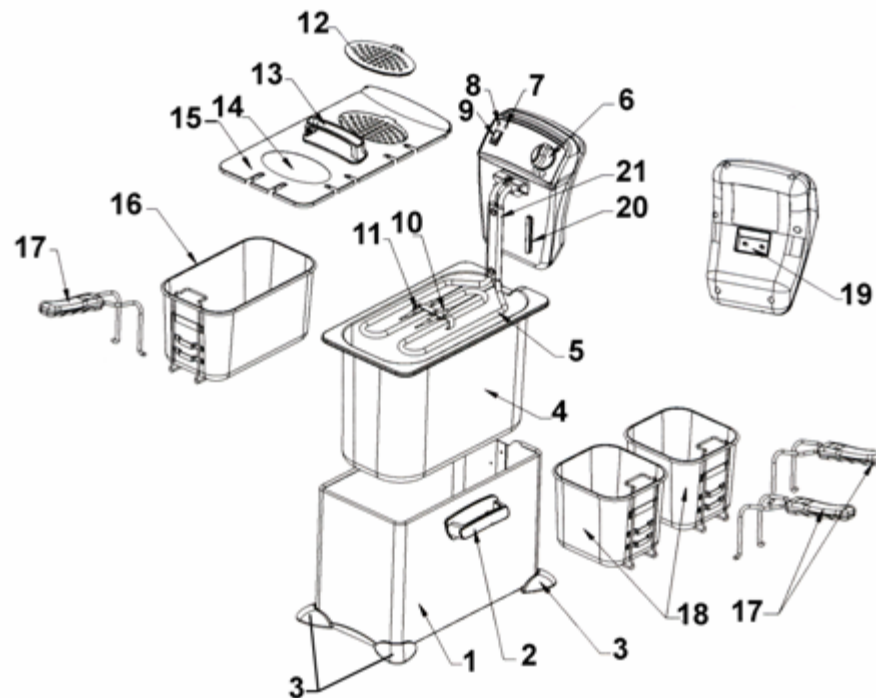

1. Body
2. Body Handle
3. Bracket
4. Oil Container
5. Heating Element
6. Adjustable Temperature Control
7. Temperature Indicator Light
8. Power "ON" Indicator Light
9. On/Off Switch
10. Thermostat
11. Limitation Thermostat
12. Detachable Filter
13. Lid Handle
14. Window
15. Fryer Lid
16. Large Frying Basket
17. Fryer Handles (x3)
18. Small Frying Basket (x2)
19. Magnetic Power Cord Socket
20. Control Panel With Heating Element
21. Heater Clip

Technical Specifications

Voltage: 120V., 60Hz.
Power: 1700 Watts
Oil Capacity: 5.5 Liters

OPERATING INSTRUCTIONS

Read all the sections of this booklet and follow all the instructions carefully.

Using for the First Time

Warning: Never plug in the control panel when it is not installed in the fryer body with heating element in the oil container. Do not immerse the control panel, cord or plug in water.

Warning: This unit should not be used to boil water.

Prior To First Use, Clean The Unit Thoroughly

Warning: Always let the fryer cool completely for 2 hours before taking it apart for cleaning. Never carry or move the Deep Fryer with hot oil inside. Before cleaning, always make sure the magnetic power plug is not in the wall socket.

- All components with the exception of the electrical parts, can be washed in warm soapy water. Dry thoroughly before use.
- Use basket handles to remove the frying baskets. Always make sure the basket handles are securely attached to the basket. To attach the handles to the frying baskets, insert the metal part of the handle inside the metal bracket on the frying basket. Lift the handle up over the basket to secure in place. (Fig. 1)
- Lift the control panel with heating element out of its slots by pushing it up from the bottom with one hand while holding the body of the deep fryer with your other hand.
- Remove the oil container.
- Clean the oil container and the frying baskets with hot water, dishwashing liquid or other non-poisonous detergent and non-abrasive sponge.

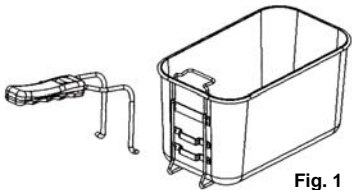

Warning: Never immerse the control panel in water or any other liquids.

Warning: All components must be completely dried before filling with oil or using. Special care must be taken to ensure the washable oil filter in the lid is completely dry, otherwise the filter will not function properly and may lead to steam being trapped within the fryer during use.

Warning: Never exceed "MAX" line when filling the basket with food.

Filling the Stainless Steel Container With Oil

Warning: Never plug in the Deep Fryer before filling with oil to specified level. Always make sure control panel is securely in place in the body and the heating element is inside the oil in the container before plugging in.

- Use blended vegetable oil, pure corn oil or canola (rapeseed) oil. Do not use olive oil, margarine, lard or drippings.
- The oil level must always be maintained between the minimum marked inside the oil container. Maximum oil capacity is 21 cups (5 liters). Check the oil level before each use. For best results, keep the oil close to the maximum level (21 cups/5 liters). Fig. 2
- Never mix different oils and fats together. Do not mix old and new oil.

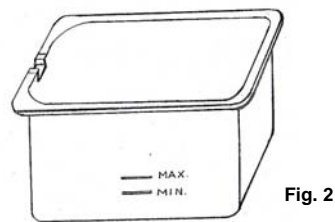

OPERATING INSTRUCTIONS cont.

Using Solid Fat

Warning: Do not put solid shortening in the oil container or the frying basket.

- If using solid vegetable shortening, melt it first in a separate pan and then very carefully pour the melted fat into the oil container.
- Previously used solid vegetable shortening which has curdled and hardened in the oil container should be removed from the oil container and melted in a separate pan before reusing.

Warning: If you try to melt the solidified fat in the oil container, there is a risk of warm melted fat suddenly sputtering from below through the still solid top layer of fat. Therefore use only the following procedure:

- Make sure the fat is at room temperature. If the fat is very cold, there is a greater risk of splashing.
- Using a fork, carefully make some holes in the fat. Make sure the lid is securely closed while fat is melting. Set temperature dial to 320° F (160° C).

Installing the "Control Panel With the Heating Element" Into its Place

- Lift up the Control Panel with Heating Element.
- Insert the "Guide Edges" on the Control Panel (Fig. 4) into the "Guide Rails" mounted on the metal body. (Fig. 3)
- Slide the "Guide Edges" down till the end.

Important Notice: The Automatic Safety Interlock Switch ensures that the unit will not operate unless the Control Panel has been inserted into the "Guide Rails" on the metal body correctly.

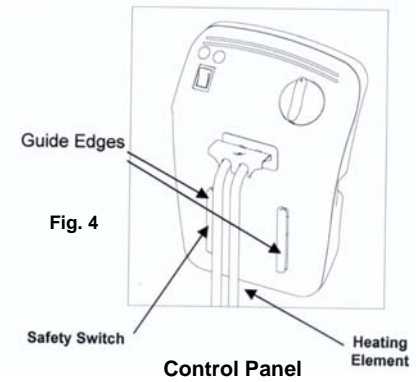
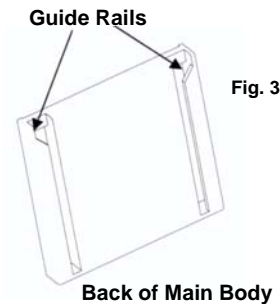

Using the Deep Fryer

Warning: Never plug in the Deep Fryer before filling with oil to specified level. Always make sure control panel is securely in place in the body and the heating element is inside the oil in the container before plugging in.

Important: Ensure the control panel is fitted correctly to the main unit otherwise the unit will not function. This is not a defect. This product is fitted with a safety interlock switch to prevent the unit from turning on accidentally.

Pre-Heating

Warning: Never plug in the Deep Fryer before filling with oil. (See "Filling" instructions on page 3.) Always unplug the appliance when not in use.

- Make sure the oil level in the oil container is between the "minimum" and "maximum" lines inside the oil container. Do **NOT** exceed the "MAX" line on the oil container when filling with oil.
- The frying basket should **not** be immersed in the oil during the pre-heating.
- Replace the lid cover.
- Plug the appliance into a 120-volt outlet.
- Turn the On/Off switch to the "ON" position.
- Select the desired temperature on the temperature setting dial. (Fig. 5)

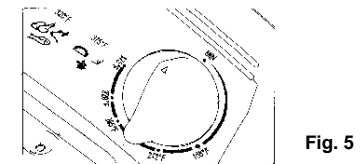

Pre-Heating (cont.)

Warning: In order to avoid injury or burns, never touch any metal parts on the deep fryer because they may be hot.

- Pre-heating the oil will take up to 15 minutes depending on the temperature selected.
- The temperature indicator light will come on when the temperature is set and the deep fryer is "on" showing that the heating element is in operation. This light goes off when the set temperature is reached. (Fig. 6) The temperature light may go on and off several times during frying. This indicates that the temperature is being thermostatically maintained.

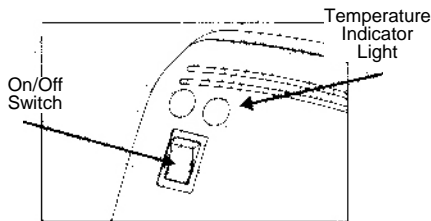

Fig. 6

Filling the Frying Basket

- Do not fill the frying basket when it is immersed in oil.
- Place the food in the frying basket. Do not overfill it and never exceed the maximum quantities. For optimum results and shorter frying time, basket should be only 1/2 full.
- The large basket has approximately 1.5 lb. food capacity. It will hold 3-4 average size pieces of chicken. The small baskets should be filled ONLY till the MAX line on the fryer basket.
- Do not fill the baskets higher than the **MAX** line on the baskets with frozen food.

Warning: When frying foods, **always** remove the frying baskets from the deep fryer before filling with food because oil will spatter and cause burns. Be especially cautious when frying frozen foods.

Caution: When frying frozen foods such as French Fries, you should not exceed 1.25 Lb. (564 gr.) in the large basket. For best crispy results limit quantity to 1 Lb. (454 gr.). Clean off any ice from frozen food prior to frying. Failure to do so may cause fryer to overflow when food is placed in oil.

Frying Food

- Always use the frying baskets to fry food.
- Always close the lid cover during frying.
- When the oil is pre-heated, ready indicator light will come on it indicating that the desired temperature is reached.
- Slowly lower the frying basket into the hot oil. Lowering the frying basket too quickly can result in the oil overflowing and splashing.
- Replace the lid carefully.
- It is normal for steam to escape through the sides of the lid while frying.
- Avoid standing too close to the deep fryer while it is working.

Warning: When opening the lid cover after frying, lift up the lid slightly, then wait to allow steam to escape before opening the lid completely. Keep face away from unit to avoid burns caused by escaping steam.

At the End of Cooking

Warning: When you have finished frying, always turn the temperature setting dial to lowest position, turn off power switch and unplug the deep fryer from wall outlet. To avoid injury or burns, do not touch any metal surfaces as they are hot.

- Set the temperature setting dial to the lowest position, (turn fully counter clockwise.)
- Turn On/Off switch to the "OFF" position.
- Unplug the main cord from the wall socket.
- Lift up the lid cover slowly and wait to allow steam to escape before opening the lid cover completely.
- Lift up the frying baskets by the handle. Place it (them) on the oil container and allow the food to drain for a minute.
- Once the oil has drained from the frying basket, the basket may be lifted off and the food served.

Warning: Always let the deep fryer cool completely (approximately 2 hours) before cleaning or storing. Never carry or move the deep fryer with hot oil inside.

Frying Tips

- Do not mix different oils or new and old oil together.
- Replace oil regularly. In general, oil will be tainted fast when frying food containing a lot of protein, (such as poultry, meat and fish). When oil is used mainly to fry potatoes and is filtered after each use, it can be used up to 8 to 10 times, but do not use the same oil for more than 6 months.
- Always replace all oil as soon as it starts foaming when heated or when color becomes dark or when it has a rancid smell or taste or becomes syrupy.
- Make sure that the food to be fried is dry.
- Remove loose ice from frozen food before frying. Rinse and pat dry.
- To cook evenly, pieces should be the same size and thickness.
- Thicker pieces will take longer to cook.

Important: When frying frozen food such as French Fries in the large frying basket, you should not exceed 1.25 lb. (568 gr.). For best results, limit quantity to 1 Lb. (454 gr.) or less.

Temperature Settings

The following cooking times reflect only the approximate time needed to fry one basket 1/2 full. The exact time may be different depending on actual quantity, personal cooking preferences, size and thickness of pieces, etc...

In general, use lower settings for delicate foods (vegetables, fish) and higher settings for frozen foods, French Fries and Chicken.

Food	Cooking Time	Temperature
French Fries	6-9 minutes	375°F
Fish Fillets	3-5 minutes	320°F
Chicken Fingers	6-8 minutes	350°F
Chicken Pieces	13-20 minutes	350°F
Fried Zucchini	3 minutes	320°F
Fried Mushrooms	3 minutes	320°F
Onion Rings	3 minutes	320°F
Donuts	3-5 minutes	350°F
Apple Beignets	4 minutes	350°F
Shrimp	4-6 minutes	320°F

Filtering & Changing The Oil

- Make sure the deep fryer is unplugged and the oil has cooled before cleaning or storing the deep fryer.
- The oil does not need to be changed after each use. In general, the oil will be tainted rather quickly when frying food containing a lot of protein (such as poultry, meat or fish). When oil is mainly used to fry potatoes and is filtered after each use, it can be used 8 to 10 times. However, do not use the same oil for longer than 6 months.
- To filter the oil first make sure the oil has cooled and then empty the oil from the oil container into another container or bottle. Fig. 7
Wash and dry the oil container and basket. Refill the oil container with the oil, pouring the oil through a wire strainer or paper filter. Fig. 8

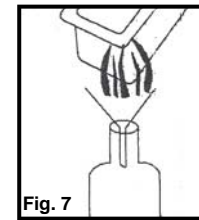

Fig. 7

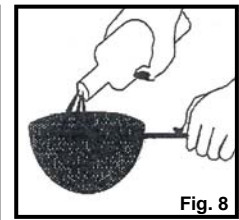

Fig. 8

Cleaning Instructions

Warning: Always remove the plug from the wall socket before cleaning. Allow the deep fryer and the oil to cool completely (approximately 2 hours) before cleaning. Never immerse the control panel, cord or plug in water or any other liquid.

- Follow the cleaning instructions on page 3. (Before using for the First Time)
- Never immerse the control panel, cord or plug in water or any other liquid.
- Do not place the control panel, cord or plug in the dishwasher.
- Clean the control panel only with a damp cloth.
- The oil container, frying basket, lid cover and filter can be washed in the dishwasher.
- The body of the deep fryer can be washed in warm soapy water. **Do not** put the body of the deep fryer in the dishwasher.
- Any other servicing should be performed by **EURO-PRO Operating LLC**.

Detachable Magnetic Power Cord

Your **EURO-PRO X** Deep Fryer has been specifically designed with your safety in mind. **EURO-PRO X** has incorporated a unique detachable power supply cord. This power supply cord is designed to “Break Away” from the fryer body in the event that the supply cord is inadvertently pulled. This is intended to prevent the tipping of the appliance and hazardous spillage of hot oil.

The female receptacle portion of the power supply cord is permanently attached to the rear of the the control panel.

To connect the male power cord plug to the female receptacle on the appliance, orient the male plug so that it mates with the female receptacle. The male plug can only be inserted one way. If the male plug will not go into the receptacle on the appliance, rotate the male plug 180°

IMPORTANT: Should the male plug become detached from the appliance during use, it is important to:

1. Unplug the power cord from the wall outlet.
2. Turn off the appliance at the control panel.
3. Re-attach the power cord to the appliance.
4. Re-connect to power outlet.
5. Turn the appliance back on.

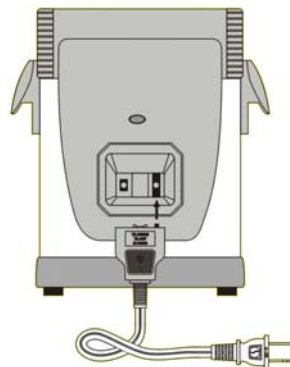

ONE (1) YEAR LIMITED WARRANTY

EURO-PRO Operating LLC warrants this product to be free from defects in material and workmanship for a period of one (1) year from the date of the original purchase, when utilized for normal household use, subject to the following conditions, exclusions and exceptions. If your appliance fails to operate properly while in use under normal household conditions within the warranty period, return the complete appliance and accessories, freight prepaid. For Customer Service support, call 1 (800) 798-7398 or visit our website www.euro-pro.com.

If the appliance is found to be defective in material or workmanship, **EURO-PRO Operating LLC** will repair or replace it free of charge. Proof of purchase date and \$ 14.95 to cover the cost of return shipping and handling must be included. *

The liability of **EURO-PRO Operating LLC** is limited solely to the cost of the repair or replacement of the unit at our option. This warranty does not cover normal wear of parts and does not apply to any unit that has been tampered with or used for commercial purposes. This limited warranty does not cover damage caused by misuse, abuse, negligent handling or damage due to faulty packaging or mishandling in transit. This warranty does not cover damage or defects caused by or resulting from damages from shipping or repairs, service or alterations to the product or any of its parts, which have been performed by a repair person not authorized by **EURO-PRO Operating LLC**.

This warranty is extended to the original purchaser of the unit and excludes all other legal and/or conventional warranties. The responsibility of **EURO-PRO Operating LLC** if any, is limited to the specific obligations expressly assumed by it under the terms of the limited warranty. **In no event is EURO-PRO Operating LLC** liable for incidental or consequential damages of any nature whatsoever. Some states/provinces do not permit the exclusion or limitation of incidental or consequential damages, so the above may not apply to you.

This warranty gives you specific legal rights, and you may also have other rights which vary from state to state or province to province.

***Important: Carefully pack item to avoid damage in shipping. Be sure to include proof of purchase date and to attach tag to item before packing with your name, complete address and phone number with a note giving purchase information, model number and what you believe is the problem with item. We recommend you insure the package (as damage in shipping is not covered by your warranty). Mark the outside of your package “ATTENTION CUSTOMER SERVICE”. We are constantly striving to improve our products, therefore the specifications contained herein are subject to change without notice.**



OWNERSHIP REGISTRATION CARD FOR CANADIAN CONSUMERS ONLY

Please fill out and mail the product registration card within ten (10) days of purchase in order to validate the foregoing Limited Warranty. The registration will enable us to contact you in the unlikely event of a product safety notification. By returning this card you acknowledge to have read and understood the instructions for use, and warnings set forth in the accompanying instructions.

RETURN TO **EURO-PRO Operating LLC**, 4400 Bois Franc, St. Laurent, Qc, H4S 1A7

K4320

Appliance model

Date purchased

Name of store

Owner's name

Address

City

Prov.

Postal code