

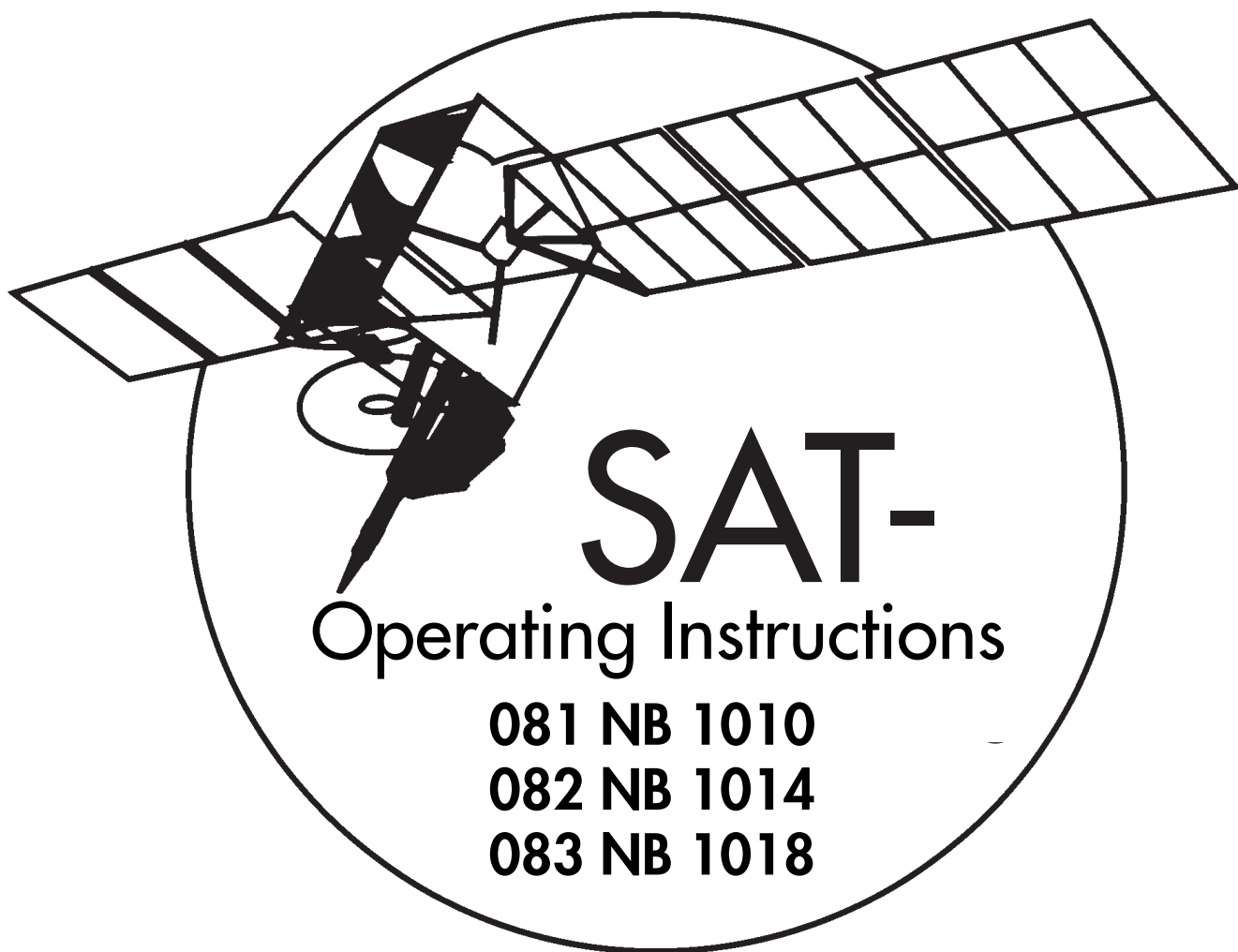

TV • VIDEO • CAMCORDER • MECABLITZ



SAT-

Operating Instructions

081 NB 1010

082 NB 1014

083 NB 1018

Preface

Dear Customer,

we congratulate you on the purchase of the SAT Upgrade Kit which enables you to receive the programs transmitted via TV satellites without the need for a separate SAT receiver and an additional remote control.

These operating instructions explain the operation of your TV set for the reception of satellite programs.

The settings for the best-known TV and radio satellite programs transmitted via the satellites ASTRA, HOTBIRD and EUTELSAT (see satellite transmitter table) have been programmed in the factory, ready for use.

Chapter „1. SAT Programming“ describes how to quickly assign the desired programs.

Your METZ-WERKE

Contents

Preface	2
Contents	2
Index	2
Differences in the permanent Display	2
1. SAT programming	3
LNC frequency (100 Hz)	3
LNC frequency (50 Hz)	5
Transferring programs (50 Hz)	6
2. LNC power supply	7
Setting the LNC voltages	7
3. Polarizer	9
4. Aerial control	10
Assigning LNC or polarizer values	10
SAT frequency input / station search	12
Switch off AFC (Automatic Frequency Control)	13
5. SAT sound settings	14
Sound mode	14
Muting (for SAT radio programs)	14
Bandwidth, deemphasis	15
6. Picture adjustment	16
Video level	16
7. Decoder operation	17
Video signal	17
8. Recording SAT programs	18
9. Timer-controlled recording of SAT programs	20
10. SAT radio operation	21
11. SAT-ADR radio operation	23
12. Technical data	25
13. Accessories	25
14. Program position management for SAT	26

Index

22 kHz switching,	3, 6
AFC switch off,	13
Bandwidth,	15
Deemphasis,	15
Multi-switch system,	3
Muting,	14
Picture signal,	17
Decoder operation,	17
Radio reception,	21
Recording SAT programs,	18, 19
Relay,	11
Station search,	12

Differences in the permanent display

In TV sets with more than 200 program positions, the TV and radio program positions are managed in two separate station tables. This difference is indicated as follows in the permanent display:

P01 stands for SAT-TV program position 01

R01 stands for SAT-radio program position 01



The SAT-radio station table is identified by a blue header line, while the SAT-TV station table has a red header line.

1. SAT Programming

LNC frequency
for 100 Hz sets

The most popular SAT stations are already stored in this TV set (see the station table). These stations are divided into the following groups: ASTRA TV stations, HOTBIRD TV stations and EUTELSAT TV stations. Each of these groups can be assigned only in its entirety and is stored starting at the programme position you specify. In the case of the ASTRA satellite, the group is subdivided into TV and radio stations.

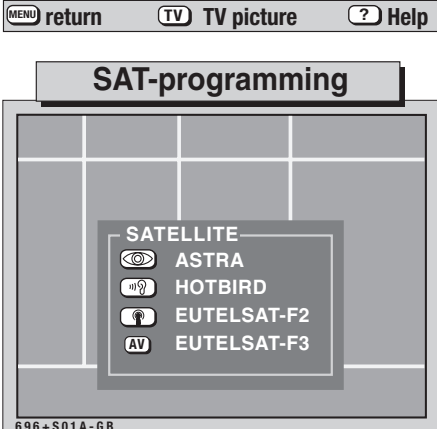
Example: You want to store all of the ASTRA TV stations, in the order in which they are listed in the station table, starting at programme position 01.

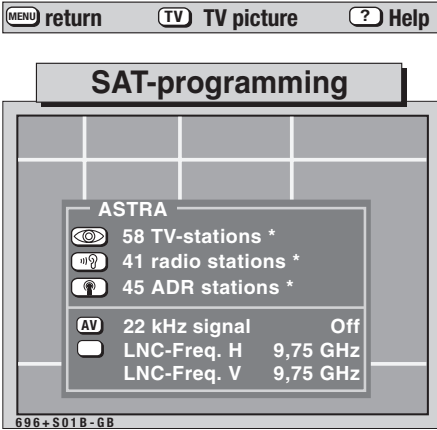
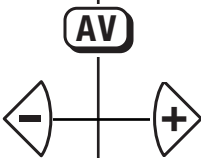
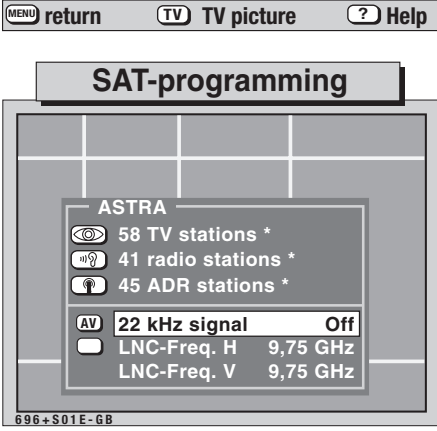
Press this key on the remote control	The screen displays	Explanation
<p>1. Call the menu „SAT programming“</p> 		<p>In this menu, you can select the various satellites. The available stations will change depending on which satellite is selected.</p>
<p>2. Select the desired satellite (in this example, ASTRA)</p> 		<p>Depending on the satellite you have selected, various TV and radio stations are presented for selection. The number of stations of each type is shown in figures.</p> <p>! In TV sets which can manage more than 200 program positions, a separate station table is generated for SAT radio stations. This table contains only radio stations.</p> <p>* Number of stations as in January 1997</p> <p>! ADR stations can be selected only if the ADR-SAT upgrade kit is installed!</p>
<p>3. Set the 22 kHz switching signal</p> 		<p>This setting is required only for multi-switch systems with a 22 kHz switching signal. If you select On, the subsequently stored programme table will be stored with this setting (= 22 kHz signal on).</p> <p>The 22 kHz switching signal can be switched on or off, depending on the frequency.</p> <p>* Number of stations as in January 1997</p>

1. SAT Programming

LNC frequency
for 100 Hz sets

Press this key on the remote control

The screen displays

Explanation

4. Set the LNC frequencies

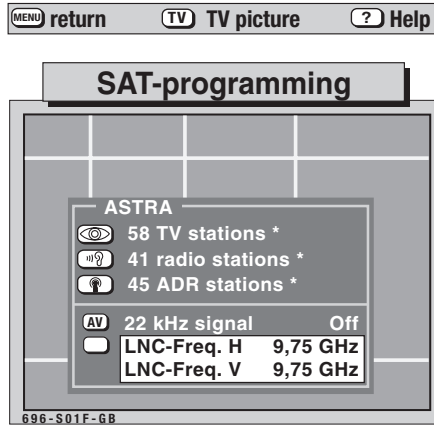
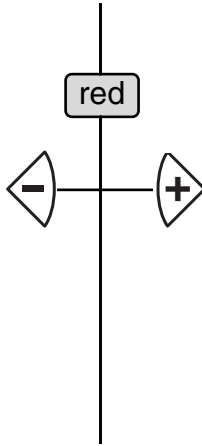

Before your transfer the desired group of SAT stations, you must always set and store the required LNC frequencies.

If these LNC frequencies are not set, the stations will not be stored with the correct channel number or the TV set will be tuned incorrectly if you enter a station frequency. In such cases, no picture will be displayed when you select the related programme position or a station which is stored in another programme position will appear.

If you press the red key once, you can adjust the LNC frequencies for vertical and horizontal polarisation together with the \leftarrow \rightarrow keys.

If you press the red key twice, only the LNC frequency for vertical polarisation is selected for adjustment with the \leftarrow \rightarrow keys. The LNC frequencies are stored together with the stations.

5. Select the desired stations (in this example: ASTRA)

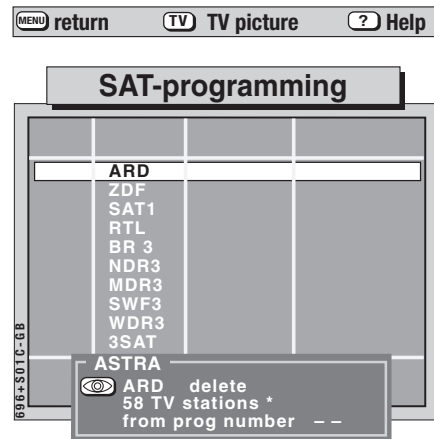
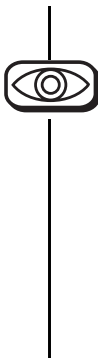

The first 10 program positions of the selected group of stations are displayed in the station table.

You can now select individual stations with the \uparrow and \downarrow keys and delete them by pressing the eye key.

This can be done, for example, to remove encoded stations for which you have no decoder.

* Number of stations as in January 1997

6. Select the first programme position

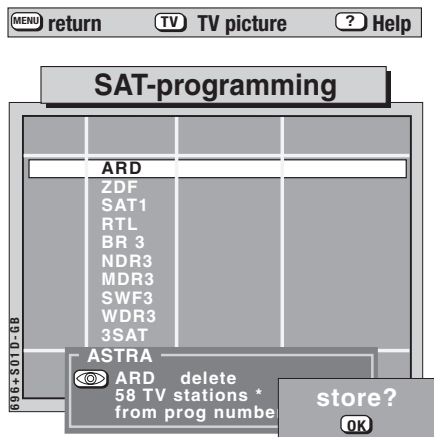
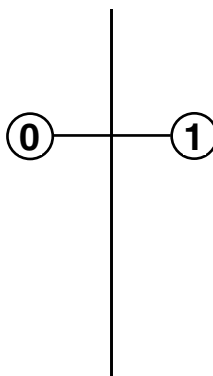

The TV set now asks for the first program position, i.e. the programme position at which storage of the stations is to start. Enter the desired program position with the numerical keys. The selected stations will then be stored continuously, starting at this program position.



In TV sets which can manage more than 200 program positions, a separate station table (with blue header line) is generated for SAT radio stations. This table contains only radio stations. The function can be cancelled at this point by pressing the TV key; the stored settings are not changed.

7. Store the stations and return to the TV picture



The selected stations are copied from the station table to the programme storage.

After the transfer, you can sort the stations as described in Section 3.1 of the Operating Instructions for the TV set.

1. SAT Programming

LNC frequency
for 50 Hz sets

The most popular SAT stations are already stored in this TV set (see the station table). These stations are divided into the following groups: ASTRA TV stations, ASTRA radio stations and EUTELSAT TV stations. Each of these groups can be assigned only in its entirety and is stored starting at the program position you specify.

Example: You have programmed your TV set to receive terrestrial stations (stations you receive via the normal aerial) on program positions 1 to 3. You now want to store all of the ASTRA TV stations, in the order in which they are listed in the station table, starting at program position 4.

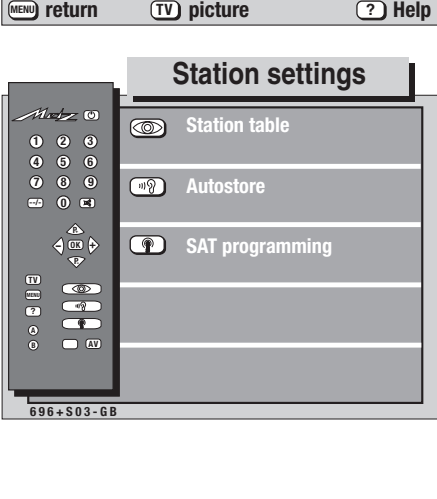
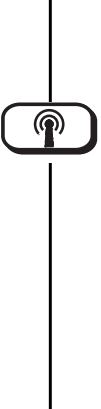
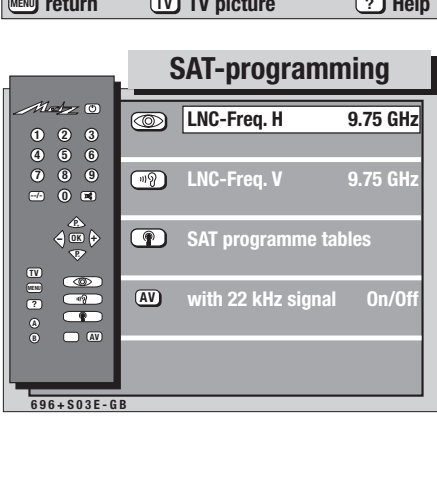
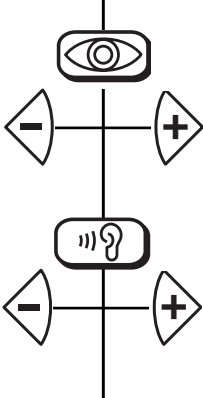
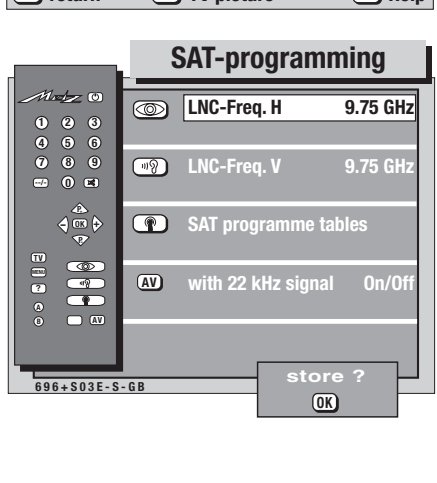
Press this key on the remote control	The screen displays	Explanation
<p>1. Call the menu „Station settings“</p> 		<p>The Autostore function can be selected only if a terrestrial tuner (for reception via a normal aerial) is fitted in your TV set.</p>
<p>2. Call the menu „SAT programming“</p> 		
<p>3. Set the LNC frequencies</p> 		<p>Before your transfer the desired group of SAT stations, you must always set and store the required LNC frequencies.</p> <p>The values to which the LNC frequencies V and H are set depending on the LNCs used in your SAT aerial. They may be set to frequencies in the range of 9.50 GHz to 12.00 GHz. Please consult the technical data of your SAT aerial for the correct values.</p> <div style="border: 1px solid black; padding: 5px;"> <p>If these LNC frequencies are not set, the stations will not be stored with the correct channel number or the TV set will be tuned incorrectly if you enter a station frequency. In such cases, no picture will be displayed when you select the related program position or a station which is stored in another program position will appear.</p> </div>

1. SAT Programming

Transferring programs
for 50 Hz sets

Press this key on the remote control

The screen displays

Explanation

4. Select the LNC (necessary only for multi-switch systems)

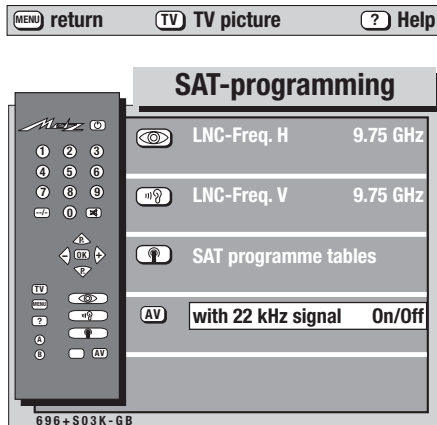
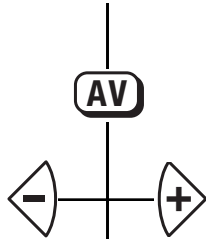

This setting is required only for multi-switch systems with a 22 kHz switching signal.

If you select **On**, the subsequently stored program table will be stored with this setting (= 22 kHz signal on).

5. Select the menu „SAT program tables“

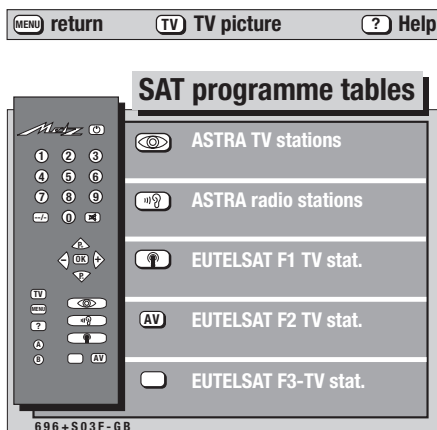

This menu shows the various groups of SAT programs. With the aid of the colored keys, you can select the desired group and then transfer this entire group.

The number of stations indicates how many stations are stored.

The number of stations depends on the previously selected V and H LNC frequencies.

6. Select „ASTRA TV stations“ and enter the program position (in this example: 04)

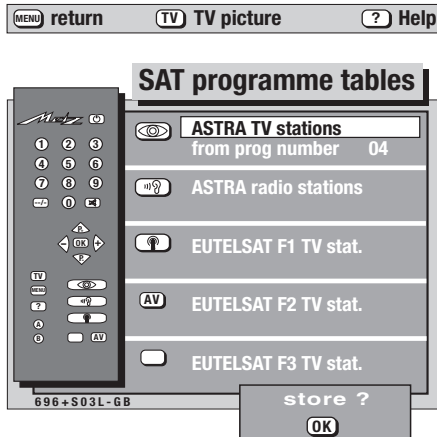
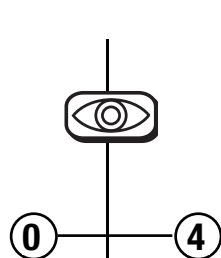

When you select a group, the text „from prog. number - - “ is displayed on the next line.

Enter the number of the program position at which the first station of the group is to be stored (the remaining stations of the group will be stored in the following program positions).

The precise assignments and the order of the stations can be found in the enclosed station table.

You can terminate the function with the TV key at this point without losing the previously stored settings.

7. Transfer the stations to the program positions and return to the TV picture



Back to the example:

All ASTRA TV stations are copied from the station table to the program storage, starting at program position 04.

Any program settings already stored in these positions will be overwritten and are thus lost.

If you wish to change the program assignments, you can sort, copy or delete the settings of the program positions as described in Section 3.1 of the Operating Instructions for the TV set.

2. LNC Power Supply

Setting the LNC voltages

TV satellites such as ASTRA 1A - D transmit the various programs with vertical (V) or horizontal (H) polarization.

If the polarization of your satellite aerial is switched by means of the LNC voltage, you must set the appropriate voltage for each station.

The two voltages which are required for selection of the polarization can be set in the menu „LNC power supply“.

For each station listed in the station table, one of these two voltages must then be assigned in the submenu „Aerial control“.

! If you are connected to a community aerial, the LNC voltages must always be set to „Off“.

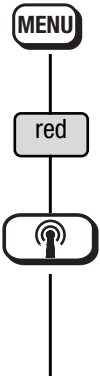
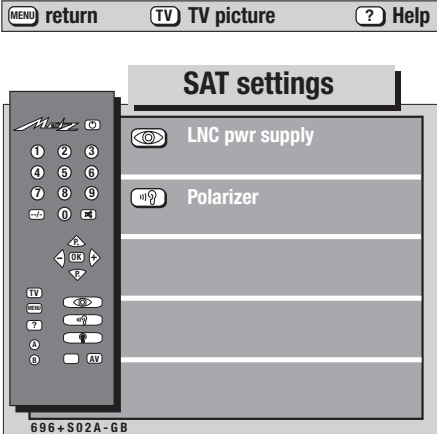
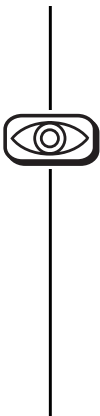
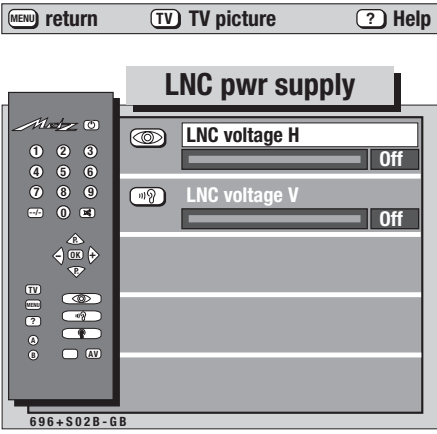
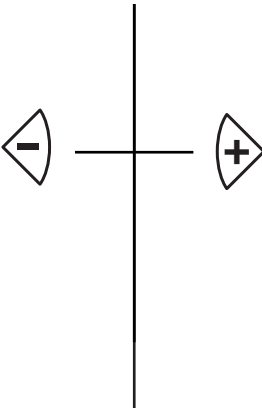
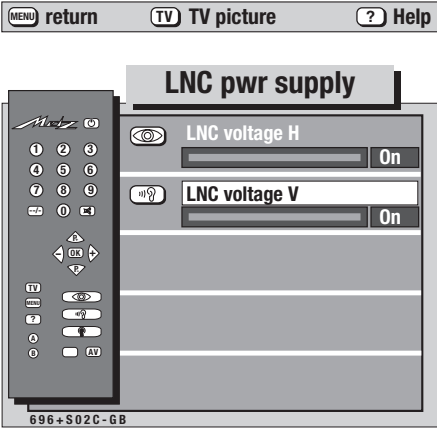
Press this key on the remote control	The screen displays	Explanation
<p>1. Call the menu „SAT settings“</p> 		<p>These settings can be made only for SAT program positions.</p> <p>The supply voltages and the control of the satellite aerial can be set in this menu.</p> <p>The LNC voltages are necessary to permit selection of either horizontal (H) or vertical (V) polarization.</p>
<p>2. Call the menu „LNC power supply“</p> 		<p>The supply voltages required for setting the LNC to horizontal and vertical polarization are set here.</p> <p>If your TV set is connected to a community aerial, LNC voltage H and LNC voltage V <u>must</u> both be set to OFF in order to prevent damage to the community aerial.</p> <p>To do this, press the ◀ key several times until Off is displayed.</p> <p>Store the selected values by pressing the OK key.</p>
<p>3. Set „LNC voltage H“</p> 		<p>The supply voltage for the SAT aerial can be set to Off or to a voltage in the range of 12 V to 19 V. When the correct voltage is set, the picture from the SAT station being received on this program position appears behind the menu display.</p> <p>Whenever the voltage setting is changed, a red box appears at the bottom right of the screen. When you have set the correct voltage, press the OK key to store it.</p>

2. LNC Power Supply

Setting the LNC voltages

Press this key on the remote control

The screen displays

Explanation

4. Set „LNC voltage V“

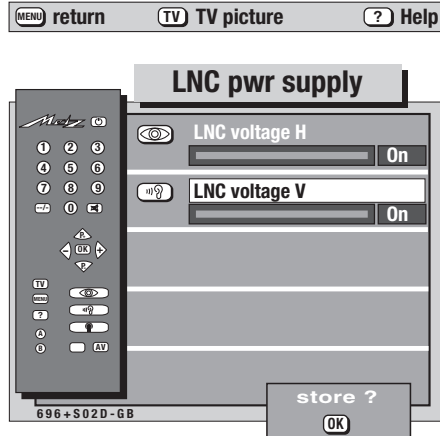
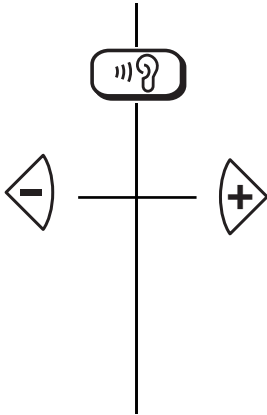

The supply voltage for the SAT aerial can be set to **Off** or to a voltage in the range of 12 V to 19 V. When the correct voltage is set, the picture from the SAT station being received on this program position appears behind the menu display.

Whenever the voltage setting is changed, a red box appears at the bottom right of the screen. When you have set the correct voltage, press the **OK** key to store it.

One of these two voltages can subsequently be assigned to each SAT program position. To do this, call the station table, open the menu „**Channel**“ with the **Help** key and then, in the submenu „**Aerial control**“, select the LNC supply voltage **H** or **V** with the **Left/Right** keys . See section 4 of these instructions.

5. Store the settings

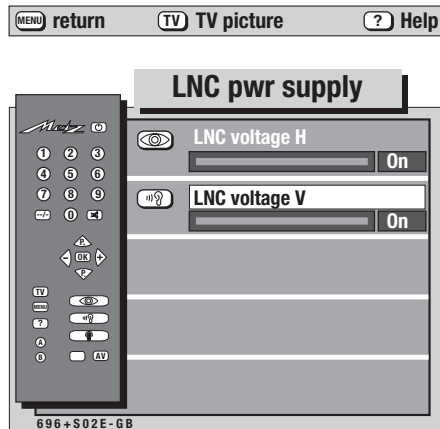
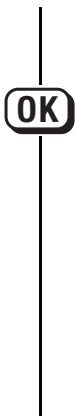

Pressing the **OK** key stores the values you have set.

6. Return to the TV picture





3. Polarizer

Setting the polarizer values

In some satellite aerials, horizontal (H) and vertical (V) polarization of the LNC is selected by means of a magnetic polarizer.

With this type of aerial, up to 5 current values (polarizer 1..5) are sent via the polarizer socket (on the back of the TV set) to the magnetic polarizer, which then sets the appropriate polarization.

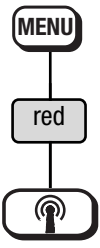
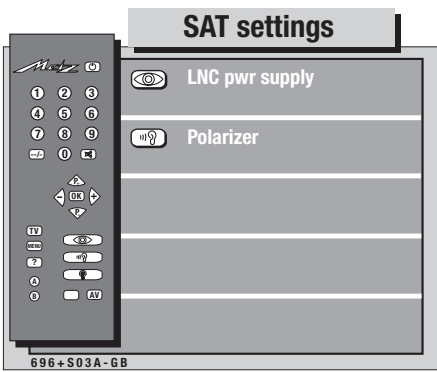
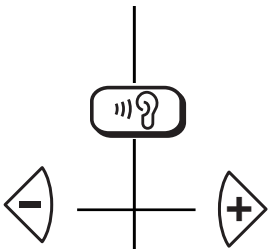
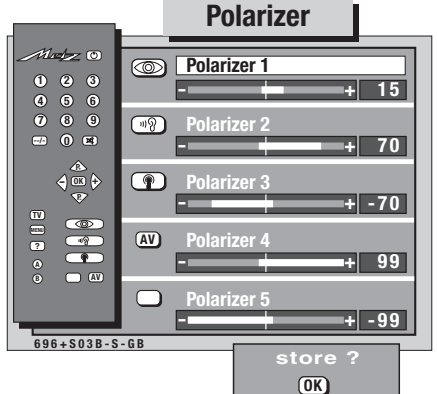
You can set 5 global polarizer values, which can then be assigned individually to the various program positions in the submenu „Aerial control“.

Press this key on the remote control	The screen displays	Explanation
<p>1. Call the menu „SAT settings“</p> 		
<p>2. Call the menu „Polarizer“ and set polarizer 1</p> 		<p>These settings can be carried out only on SAT program positions and should be made only if your SAT aerial has a magnetic polarizer.</p> <p>The polarizer settings can be used to select H or V polarization.</p> <p>The polarization angle can be adjusted to match the satellite with the \leftarrow \rightarrow keys.</p> <p>The polarization angle can be adjusted in individual steps in the ranges 0 to +99 and 0 to -99. The received TV picture is visible behind the menu display.</p> <p>Adjust the polarizer setting until the received picture is free of interferences.</p> <p>Polarizers 2 to 5 can be selected with the colored keys and adjusted as described above with the \leftarrow \rightarrow keys.</p>
<p>3. Store the polarizer setting and return to the TV picture</p> 		<p>When the TV picture is free of interference, the polarizer setting can be stored by pressing the OK key.</p> <p>One of the five polarizer settings set in this menu can be selected for each SAT program position. This is done in the submenu „Aerial control“ of the SAT program positions in the station table - see section 4 of these instructions.</p>

4. Aerial Control Assigning LNC or polarizer values

Depending on the type of satellite aerial you use, there are three methods of aerial control for selection of **H** and **V** polarization:

- control by means of the LNC voltage (the most common method),
- control with the aid of a magnetic polarizer,
- control with a relay.

The appropriate control method for polarization must be selected in the station table. **H** for horizontal polarization or **V** for vertical polarization is displayed in the submenu „Aerial control“ of this table.

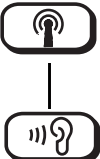
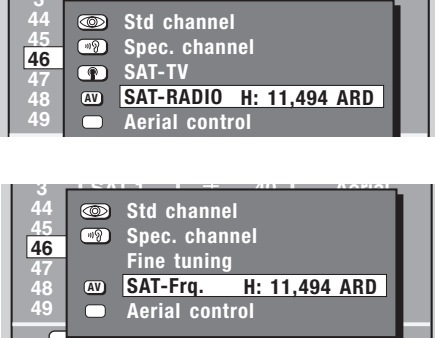
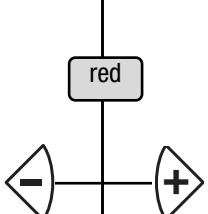
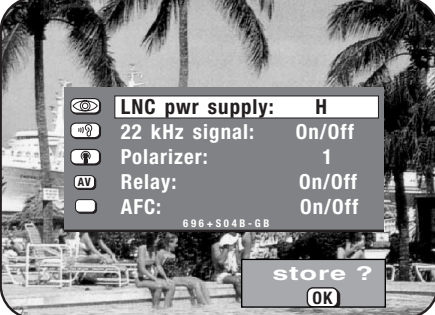
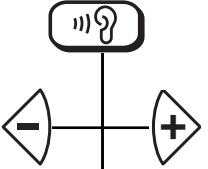
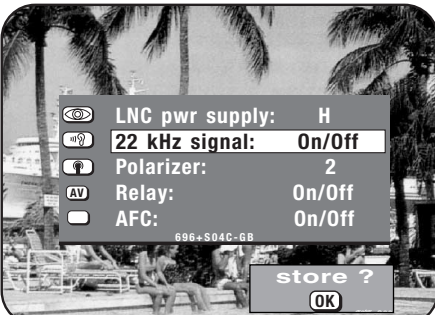
Press this key on the remote control	The screen displays	Explanation
<p>1. Call the station table and select the submenu „Channel“</p> 		<p>The frequency setting may differ from model to model, as shown in the picture.</p>
<p>2. Call the submenu „Aerial control“ and set the LNC voltage</p> 		<p>In this submenu, one of the previously set values (see sections 1 and 2 of these operating instructions) can be selected and assigned to the current SAT program position. This is done with the aid of the colored keys.</p> <p>When you press the blue key, the text „LNC power supply“ is displayed on a blue background to indicate that it is active.</p> <p>You can select the control voltage for either H or V polarization with the \leftarrow \rightarrow keys.</p> <p>The setting of the control voltages is described in section 2 of these operating instructions.</p>
<p>3. Make the LNC selection (required only for multi-switch systems)</p> 		<p>Here you can superimpose a 22 kHz switching signal upon the LNC voltage for horizontal or vertical polarization.</p> <p>This is used to select the desired input of a multi-switch system.</p>

4. Aerial Control Assigning LNC or polarizer values

Press this key on the remote control

The screen displays

Explanation

4. Set the polarizer

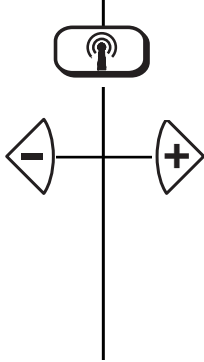

Pressing the white key causes the text **Polarizer** to be displayed on a white background to indicate that it is active.

One of the five polarizer settings (see section 3 of these operating instructions) can now be selected with the \leftarrow \rightarrow keys.

5. Set the relay control voltage

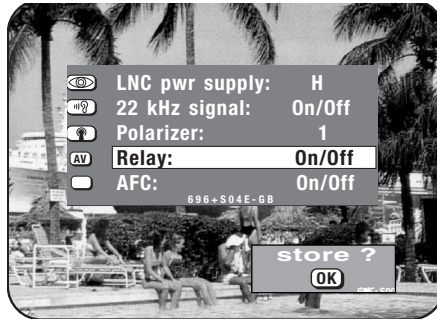
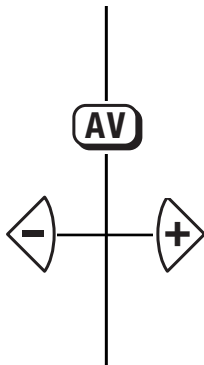

The relay can be used to send a control voltage of approximately 12 V („On“) or not („Off“).

This setting can be made individually for each program position.

6. Store the settings and return to the TV picture



4. Aerial Control SAT frequency input / station search

A station table is enclosed with the SAT upgrade kit. This station table can, as described in section 1 „SAT programming/Tansferring programs“, be transferred to sequential program positions, starting at a specified position. If the channel assignments of the SAT stations are modified, or if new SAT stations are transmitted, these can be found and stored with the station search function.

If the transponder frequency is known, this can be entered directly with the numeric keys.

Press this key on the remote control	The screen displays	Explanation
--------------------------------------	---------------------	-------------

1. Select a SAT program position and call the station table



The frequency setting may differ from model to model, as shown in the picture.

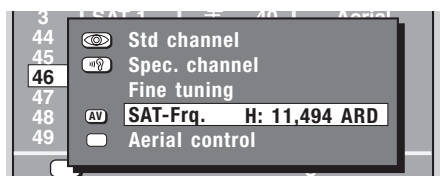

2. Enter the frequency with the numeric keys

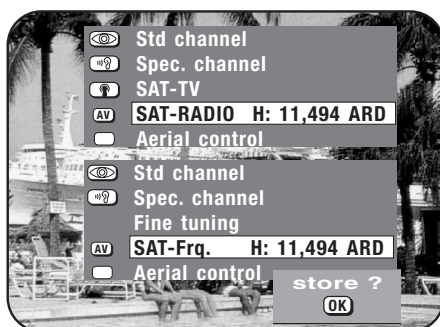
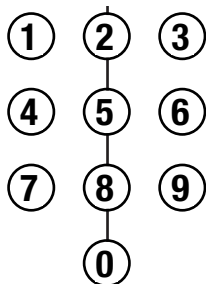

If you enter the **frequency directly**, the station table is temporarily removed to display the selected station.



The frequency input functions correctly only if the LNC frequency has been set correctly in the „SAT programming“ menu (see Section 1, „ SAT programming“, LNC frequency“).

The frequency setting may differ from model to model, as shown in the picture.

3. Start the station search

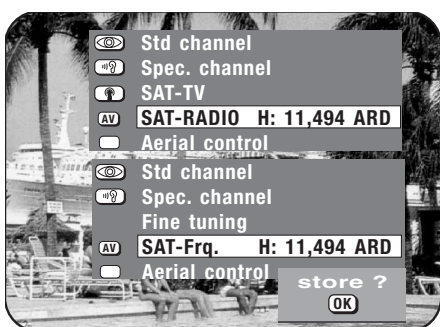
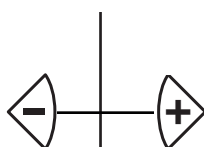

The **station search** starts at the currently displayed channel number or frequency. Pressing the key starts a search in ascending order, pressing the key, a search in descending order. When a station is found, the search stops.

If you do not wish to store this station, press the or key to resume the search.

The frequency setting may differ from model to model, as shown in the picture.

4. Store the settings and return to the TV picture

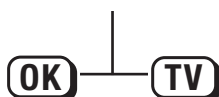

TV picture







4. Aerial Control

Switch off AFC

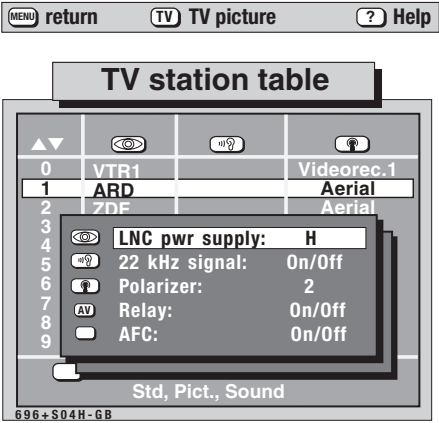
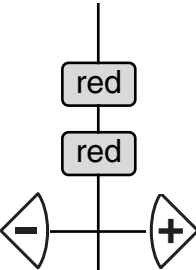
When stations are assigned to the various programme positions, they are automatically tuned to the centre frequency. This is normally satisfactory.

If the results of this automatic tuning are unsatisfactory, you can turn off the AFC (Automatic Frequency Control) function for specific programme positions and adjust the tuning manually.

Select the programme position which is to be tuned manually.

Press this key on the remote control	The screen displays	Explanation
<p>1. Call the menu „Aerial control“.</p> 		<p>The function „AFC“ is set to „On“ in the factory.</p> <p>This setting causes all programme positions to be tuned to the centre frequency.</p>
<p>2. Switch off the AFC and adjust the frequency.</p> 		<p>Call the submenu „AFC“ by pressing the red key.</p> <p>Press the red key again to switch off the AFC function.</p> <p>The frequency can then be adjusted with the  keys.</p> <p>When this is done, the station table is removed from the screen to permit better assessment of the picture quality.</p>
<p>3. Store the modified frequency and return to the TV picture.</p> 		<p>Once you are satisfied with the picture, store the settings for this programme position by pressing the  key.</p>

5. SAT Sound Settings

Muting and sound mode

All parameters for the sound adjustment for a satellite station can be programmed in the submenu „Adj. SAT sound“.

These adjustments need to be made only if new stations, whose settings are not stored in the SAT program assignments, are to be received.

Press this key on the remote control

The screen displays

Explanation

1. Call the station table and select „Further settings“

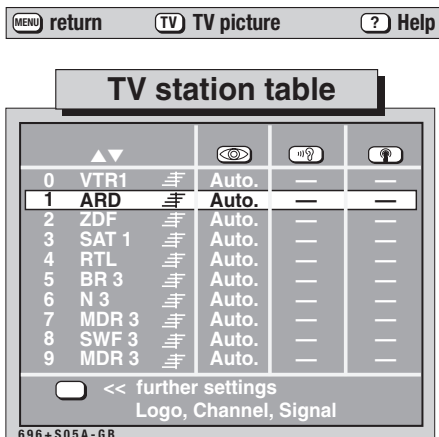
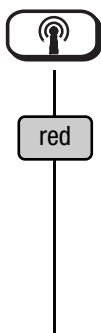

! If the TV station table is now displayed instead of the combined station table, see the instructions in Step 2.

2. Call the submenu „Sound“ and set the muting function TV set with station table

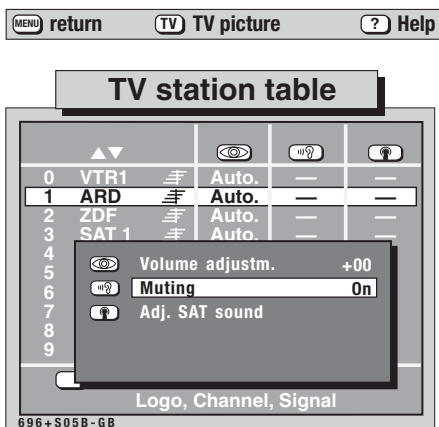
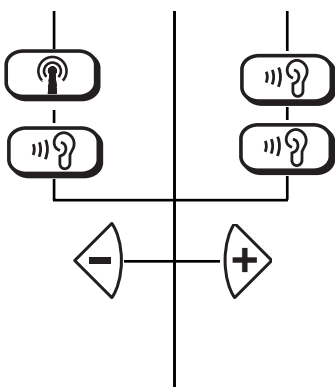

Many SAT TV stations also transmit radio programs on sound subcarriers, e.g. RTL Radio on RTL 4 (see also section 10, "SAT radio operation"). In the case of encoded SAT stations, the TV set switches the sound off because no TV station can be detected.

The muting function must be set to **Off** for the reception of such encoded SAT stations.

The muting function permits you to receive radio programs from encoded stations.

If the sound from encoded SAT stations is switched off, reception of the sound is possible only by setting the muting function to **Off**.

3. Call the submenu „Adj. SAT sound“ and set the sound mode

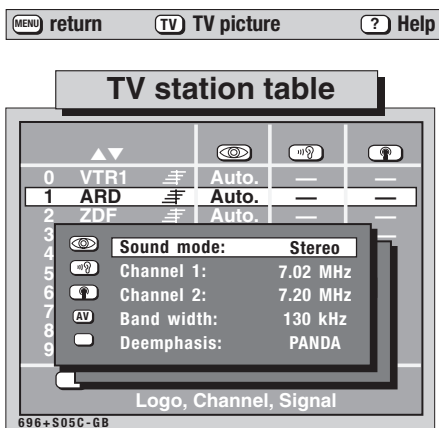
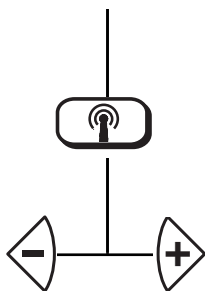

All parameters required for a SAT station can be adjusted in the submenu **Adj. SAT sound**.

These settings must be made individually for each program position.

In this menu, you can select the sound mode: **MONO**, **STEREO** or **DUAL** (for dual-channel programs).

5. SAT Sound Settings

Bandwidth, deemphasis

Press this key on the remote control

The screen displays

Explanation

4. Set „Channel 1“ and/or „Channel 2“

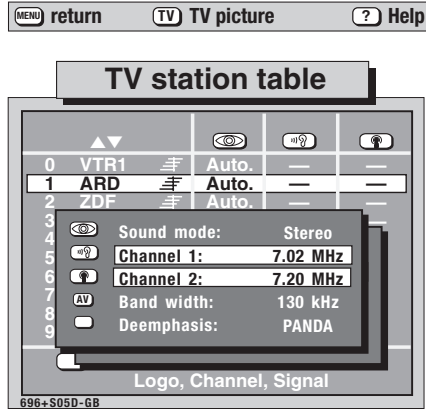
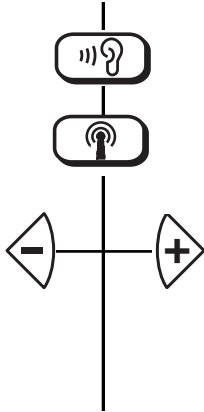

The most common sound carrier frequencies can be selected with the aid of the numeric keys of the remote control. These keys have the following assignments:

- ① 6,20 MHz ② 6,50 MHz ③ 6,65 MHz
- ④ 7,02 MHz ⑤ 7,20 MHz ⑥ 7,38 MHz
- ⑦ 7,56 MHz ⑧ 7,74 MHz ⑨ 7,92 MHz
- ⑩ 8,10 MHz

The frequency value can also be adjusted in steps of 10 kHz in the range of 5.00 MHz to 9.99 MHz with the \leftarrow \rightarrow keys.

In the case of stations which transmit stereo sound, the frequency for Channel 2 is also changed whenever that for Channel 1 is changed, since these frequencies are always 180 kHz apart. You can subsequently adjust the frequency for Channel 2 independently of that for Channel 1.

5. Set „Bandwidth“

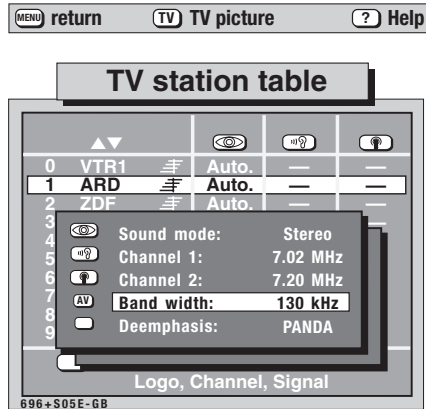
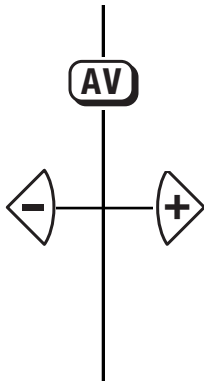

The sound carrier frequencies of some SAT stations, particularly those which use sound subcarriers, are close together and may interfere with each other. The bandwidth can be adjusted to prevent such interference. As a rule, the smallest bandwidth should be set.

Note: always select 130 kHz for ASTRA subcarriers.

A default value of 280 kHz is preset for MONO stations and a default value of 130 kHz for STEREO and DUAL stations.

6. Set „Deemphasis“

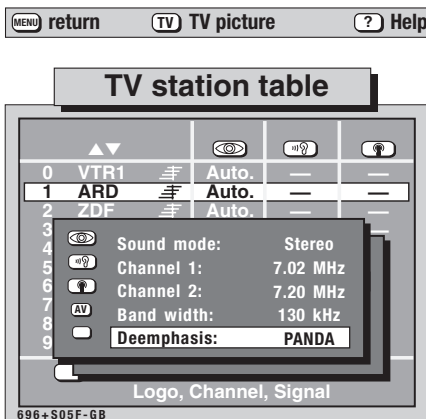
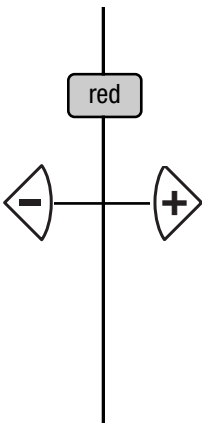

The deemphasis (a method of reducing noise on the sound channel) improves the sound quality of a SAT station.

One of the following settings may be selected:

- Off • 50µs • 75 µs • J17 • PANDA

Note: for ASTRA subcarriers, always select PANDA

The bandwidth and deemphasis are set automatically to default values when you switch between **MONO**, **STEREO** and **DUAL** sound modes. Other settings can be found in the appropriate tables in technical publications.

7. Store the settings and return to the TV picture







Pressing the **OK** causes the current settings to be stored.

6. Picture Adjustment

Video level/Bandwidth

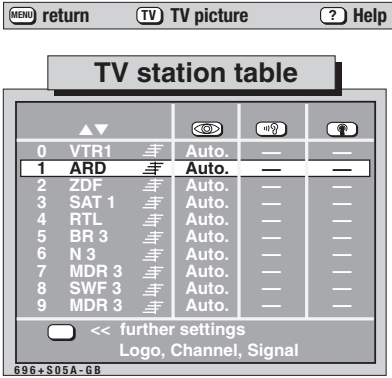
The Video level adjustment can be used to compensate for the differing modulation levels of various satellite stations and thus to maintain a constant contrast.

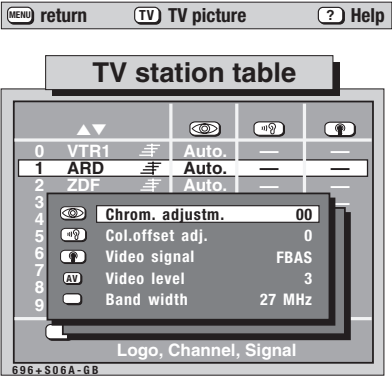

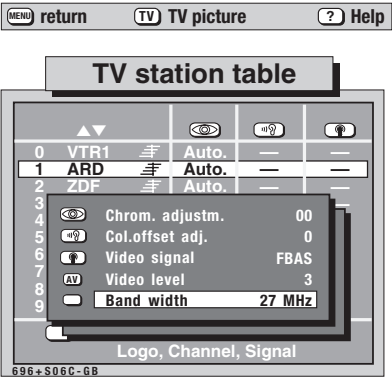

Under certain circumstances, you may be able to get rid of interference with the Bandwidth adjustment.

Press this key on the remote control	The screen displays	Explanation																																																		
1. Call the second station table	 <p>TV station table</p> <table border="1"> <tr><td>0</td><td>VTR1</td><td>Auto.</td><td>—</td><td>—</td></tr> <tr><td>1</td><td>ARD</td><td>Auto.</td><td>—</td><td>—</td></tr> <tr><td>2</td><td>ZDF</td><td>Auto.</td><td>—</td><td>—</td></tr> <tr><td>3</td><td>SAT 1</td><td>Auto.</td><td>—</td><td>—</td></tr> <tr><td>4</td><td>RTL</td><td>Auto.</td><td>—</td><td>—</td></tr> <tr><td>5</td><td>BR 3</td><td>Auto.</td><td>—</td><td>—</td></tr> <tr><td>6</td><td>N 3</td><td>Auto.</td><td>—</td><td>—</td></tr> <tr><td>7</td><td>MDR 3</td><td>Auto.</td><td>—</td><td>—</td></tr> <tr><td>8</td><td>SWF 3</td><td>Auto.</td><td>—</td><td>—</td></tr> <tr><td>9</td><td>MDR 3</td><td>Auto.</td><td>—</td><td>—</td></tr> </table> <p><< further settings Logo, Channel, Signal</p>	0	VTR1	Auto.	—	—	1	ARD	Auto.	—	—	2	ZDF	Auto.	—	—	3	SAT 1	Auto.	—	—	4	RTL	Auto.	—	—	5	BR 3	Auto.	—	—	6	N 3	Auto.	—	—	7	MDR 3	Auto.	—	—	8	SWF 3	Auto.	—	—	9	MDR 3	Auto.	—	—	 <p>If the TV station table is now displayed instead of the combined station table, see the instructions in Step 2.</p>
0	VTR1	Auto.	—	—																																																
1	ARD	Auto.	—	—																																																
2	ZDF	Auto.	—	—																																																
3	SAT 1	Auto.	—	—																																																
4	RTL	Auto.	—	—																																																
5	BR 3	Auto.	—	—																																																
6	N 3	Auto.	—	—																																																
7	MDR 3	Auto.	—	—																																																
8	SWF 3	Auto.	—	—																																																
9	MDR 3	Auto.	—	—																																																
2. Call the submenu „Picture“ TV set with station table	 <p>TV station table</p> <table border="1"> <tr><td>0</td><td>VTR1</td><td>Auto.</td><td>—</td><td>—</td></tr> <tr><td>1</td><td>ARD</td><td>Auto.</td><td>—</td><td>—</td></tr> <tr><td>2</td><td>ZDF</td><td>Auto.</td><td>—</td><td>—</td></tr> <tr><td>3</td><td>Chrom. adjustm.</td><td>00</td><td>—</td><td>—</td></tr> <tr><td>4</td><td>Col.offset adj.</td><td>0</td><td>—</td><td>—</td></tr> <tr><td>5</td><td>Video signal</td><td>FBAS</td><td>—</td><td>—</td></tr> <tr><td>6</td><td>Video level</td><td>3</td><td>—</td><td>—</td></tr> <tr><td>7</td><td>Band width</td><td>27 MHz</td><td>—</td><td>—</td></tr> </table> <p>Logo, Channel, Signal</p>	0	VTR1	Auto.	—	—	1	ARD	Auto.	—	—	2	ZDF	Auto.	—	—	3	Chrom. adjustm.	00	—	—	4	Col.offset adj.	0	—	—	5	Video signal	FBAS	—	—	6	Video level	3	—	—	7	Band width	27 MHz	—	—	<p>In SAT mode, this submenu includes the facilities for adjusting the video level and the video signal. For adjustment of chrominance and colour offset please refer to the operating instructions for the TV set.</p>										
0	VTR1	Auto.	—	—																																																
1	ARD	Auto.	—	—																																																
2	ZDF	Auto.	—	—																																																
3	Chrom. adjustm.	00	—	—																																																
4	Col.offset adj.	0	—	—																																																
5	Video signal	FBAS	—	—																																																
6	Video level	3	—	—																																																
7	Band width	27 MHz	—	—																																																
3. Adjust the video level	 <p>Chrom. adjustm. 00 Col.offset adj. 0 Video signal FBAS Video level 3 Band width 27 MHz</p> <p>store ? OK</p>	<p>The video level can be adjusted with the $\leftarrow \rightarrow$ keys to a value between 1 and 4. Use the $\leftarrow \rightarrow$ keys to adjust the video level for the best picture.</p>																																																		
4. Adjust the video bandwidth	 <p>TV station table</p> <table border="1"> <tr><td>0</td><td>VTR1</td><td>Auto.</td><td>—</td><td>—</td></tr> <tr><td>1</td><td>ARD</td><td>Auto.</td><td>—</td><td>—</td></tr> <tr><td>2</td><td>ZDF</td><td>Auto.</td><td>—</td><td>—</td></tr> <tr><td>3</td><td>Chrom. adjustm.</td><td>00</td><td>—</td><td>—</td></tr> <tr><td>4</td><td>Col.offset adj.</td><td>0</td><td>—</td><td>—</td></tr> <tr><td>5</td><td>Video signal</td><td>FBAS</td><td>—</td><td>—</td></tr> <tr><td>6</td><td>Video level</td><td>3</td><td>—</td><td>—</td></tr> <tr><td>7</td><td>Band width</td><td>27 MHz</td><td>—</td><td>—</td></tr> </table> <p>Logo, Channel, Signal</p>	0	VTR1	Auto.	—	—	1	ARD	Auto.	—	—	2	ZDF	Auto.	—	—	3	Chrom. adjustm.	00	—	—	4	Col.offset adj.	0	—	—	5	Video signal	FBAS	—	—	6	Video level	3	—	—	7	Band width	27 MHz	—	—	<p>The video bandwidth is set in the factory to 27 MHz. Reducing this to 18 MHz may result in a better picture if the aerial signal is weak or if neighbouring stations are causing interference. The bandwidth can be changed with the $\leftarrow \rightarrow$ keys.</p>										
0	VTR1	Auto.	—	—																																																
1	ARD	Auto.	—	—																																																
2	ZDF	Auto.	—	—																																																
3	Chrom. adjustm.	00	—	—																																																
4	Col.offset adj.	0	—	—																																																
5	Video signal	FBAS	—	—																																																
6	Video level	3	—	—																																																
7	Band width	27 MHz	—	—																																																
5. Store the settings and return to the TV picture	<p>TV picture</p>																																																			

7. Decoder Operation

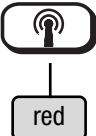
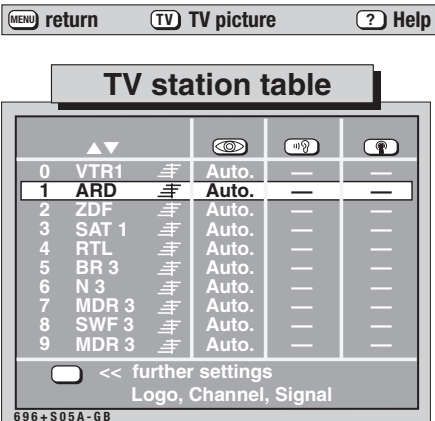
Setting the video signal

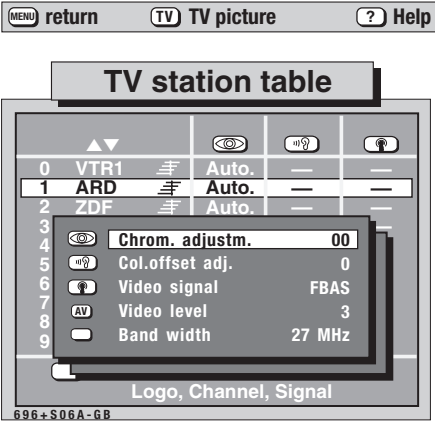
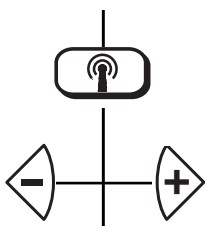
In general, the **video signal** is always set to „FBAS“ (composite color signal). If you use a decoder which requires a baseband signal (see operating instructions for your decoder), the video signal must be set to „BB“ (baseband).

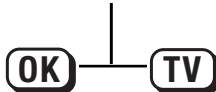



Press this key on the remote control	The screen displays	Explanation
<p>1. Call the second station table</p> 		<p>! If the TV station table is now displayed instead of the combined station table, see the instructions in Step 2.</p>
<p>2. Call the submenu „Picture“ TV set with station table</p> 		
<p>3. Set the video signal</p> 		<p>The video signal is set in the factory to FBAS. If you want to receive an encoded station, you need a decoder. Most decoders require the setting FBAS. However, some decoders require the setting BB for correct operation. You can select either FBAS or BB with the \leftarrow \rightarrow keys.</p>
<p>4. Store the setting and return to the TV picture</p> 	<p>TV picture</p>	

8. Recording SAT Programs

On TV sets with 1 EURO socket

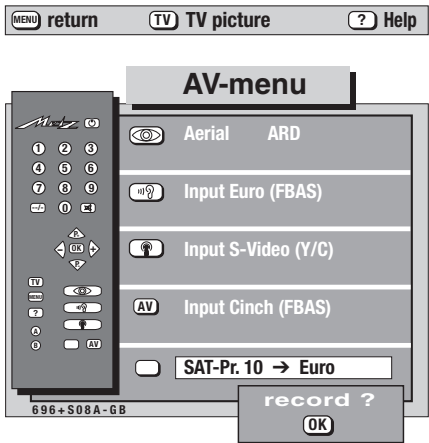
In the **AV menu**, you can define which of the connected AV devices is to supply the picture for the TV screen. Once the settings have been defined, you can switch to standby mode with the **TV** key and the defined function is executed in standby mode. **AV device** is a generic term for all external audio/video devices, such as video cassette recorders, camcorders, video disk players, photo CD players, etc., which can be connected to a TV set.

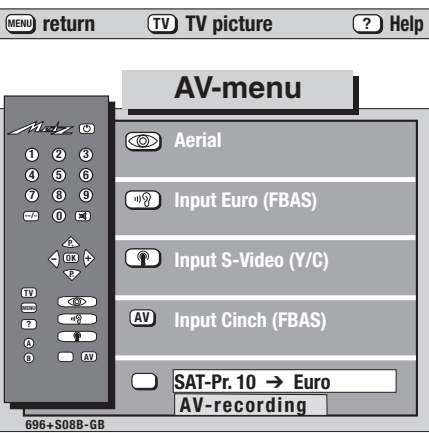
Example: You want to record the satellite program on program position 10 on your video cassette recorder (VCR), which is connected to the EURO socket. **Tune to the SAT station from which you want to record.**

Press this key on the remote control	The screen displays	Explanation
<p>1. Call the AV menu and define the signal path</p> 		<p>If program position 10 is a SAT program position, pressing the AV key causes the program position number to be displayed automatically in the line with the red background (in this example: SAT Pr 10 → Euro).</p> <p>The AV menu can also be called from any other program position and the number of the SAT program position then entered with the numeric keys. The TV set then switches to the selected SAT program position.</p>
<p>2. Confirm the setting and clear the menu</p> 		<p>The setting is confirmed with the OK key.</p> <p>You can now switch to SAT recording mode (picture and sound off) with the TV key.</p> <p>If you call the menu „Timer/childlock“ and program a switch-off time in the submenu „Time settings“, the TV set will switch from SAT recording mode to standby mode at the preset time.</p> <p>You can now switch to any other desired terrestrial program position. You cannot switch to another SAT program position; to remind you of this, a warning box is displayed if you attempt to do so.</p>
<p>3. Terminating a SAT AV recording operation</p> 		<p>Call the AV menu with the AV key and cancel the SAT recording by pressing the OK key.</p> <p>The menu can be cleared by pressing the TV key.</p> <p>Indication of SAT AV recording in standby mode: - green LED lights.</p>







On TV sets equipped with two SAT upgrade kits, you can record from one SAT station and watch another SAT station at the same time.

8. Recording SAT Programs

On TV sets with 3 EURO sockets

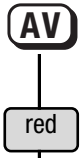
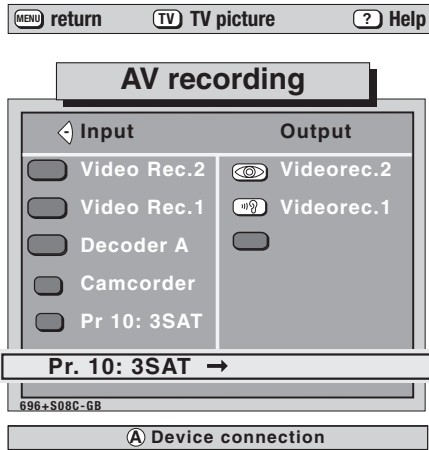
In the menu „AV recording“, you can define which of the connected video recorders is to record the SAT program. The connected video recorders do not need to have their own SAT receivers.

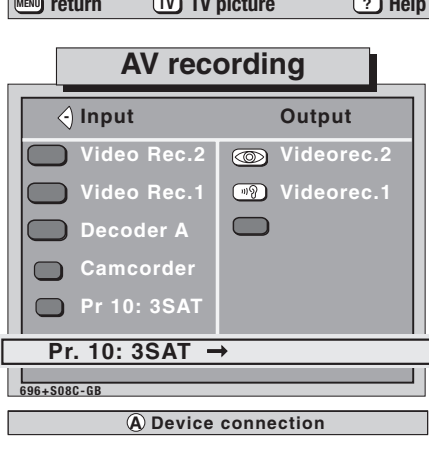
Example: You want to record a satellite program from the station on program position 10 on video recorder 1, which is connected to the EURO-2 socket. **Tune to the SAT station from which you want to record.**

Press this key on the remote control	The screen displays	Explanation
<p>1. Call the AV recording menu and define the signal path</p> 		<p>The TV set must be tuned to the station from which the program is to be recorded!</p> <p>Back to the example: The SAT program position 10 appears automatically in the footer line with the yellow border when you press the red key.</p> <p>The selected program is now available for recording on a video recorder which is selected in the next step.</p>
<p>2. Select the desired video recorder (in this example: Video rec. 1) and store the setting</p> 		<p>When you have selected the desired recorder (Videorec. 1 in this example) the recording path is shown in the footer line with the yellow frame.</p> <p>Confirm the setting by pressing the OK key.</p> <p>The text in the red box changes from „Record?“ to „Stop?“.</p> <p>If you want, you can now switch to SAT-AV recording mode (picture and sound switched off) by pressing the TV key.</p> <p>If you call the menu Timer/Childlock and set a power-off time in the submenu Time settings, the TV set will switch from SAT recording mode to standby mode at the programmed time.</p> <p>Start a direct recording on the videorecorder.</p>
<p>3. Terminating a SAT AV recording operation</p> 		<p>Call the AV menu with the AV key, press the red key and cancel the SAT recording by pressing the OK key.</p> <p>The menu can be cleared by pressing the TV key.</p> <p>Indication of SAT AV recording in standby mode:</p> <ul style="list-style-type: none"> - the program position number, e.g. PS 10, is displayed in the permanent display. <p>! On TV sets equipped with two SAT upgrade kits, you can record from one SAT station and watch another SAT station at the same time.</p>





9. Timer-controlled Recording of SAT Programs

On TV sets with 1 EURO socket

The menu **SAT timer recording** should be used only if you want to record a SAT program on a video recorder which does not have its own SAT receiver. With this menu, a SAT signal from the TV set can be made available to a simple video recorder without its own SAT receiver. **Eight SAT timers can be preset up to two months in advance.**

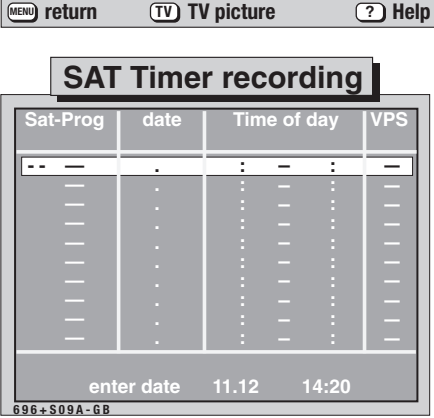
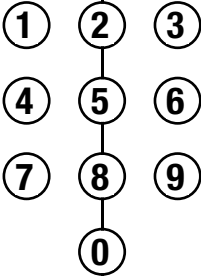
⚠ The settings for a TV set with 3 sockets is described in Section 7.1 or 8.2, „Timer recording“ of the Operating Instructions for the TV set. ⚠

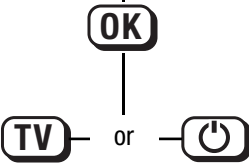
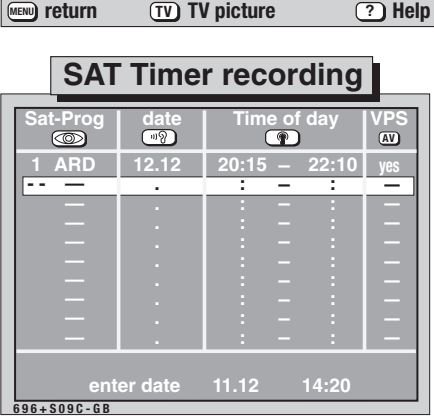
Example: On 12.12.95, you want to record a film being transmitted from 20:15 to 22:10 by the SAT station on program position 1.

Press this key on the remote control	The screen displays	Explanation
<p>1. Call the menu „SAT timer recording“</p> 		<p>If no timer recordings have been programmed previously, this table is empty. Any previously programmed settings will be displayed.</p> <p>The timer menu requires the time of day and the date. The time of day is taken from Megatext and the date from the VPS signal. Note that some stations do not transmit Megatext and/or VPS signals.</p> <p>⚠ If there is no station with VPS and/or Megatext stored in program position 01, the time and/or date cannot be set automatically and must be entered manually.</p>
<p>2. Enter the data for the program to be recorded (see example)</p> 		<p>Two digits must be entered for each position of the time and date, e.g. 01.09 for September 1st and 09:00 for 9 AM.</p> <p>If you make a mistake while entering the data, the entry in the current column or the entire line can be cleared with the  key. The entire line can be cleared only if the key symbols in the top line are displayed in color.</p> <p>⚠ If the childlock is active, you cannot execute a SAT timer recording.</p>
<p>3. Store the programmed data and return to the TV picture or to standby mode</p> 		<p>If the TV set is not receiving a VPS signal when you are programming it, a VPS signal can be set manually with the  key. If you have programmed a timer with VPS and switched the TV set to standby mode, a TV set with 7-segment display will display „SCAN“ about one hour before the programmed start time to indicate that it is scanning for the VPS start signal.</p> <p>If desired, the timer recording can be terminated at any time as described in section 8, step 3.</p> <p>The same data for the time of day and date must be programmed into the video recorder on the AV program position or on a program position on which the video recorder does not receive a TV station. An MVS system (optional extra) does this automatically.</p>

10. SAT Radio Operation Programming radio stations

Many SAT stations use so-called „sound subcarriers“ to transmit additional radio programmes. One SAT station can transmit several additional radio programmes. Some radio stations are already programmed in the factory (see the SAT station table, „ASTRA radio stations“). These can be assigned to programme positions with the aid of the menu „SAT programming“ (see Section 1).

Proceed as follows if you wish to programme a new station that is not listed in the SAT station table.

Example: You want to programme the SAT radio station „NDR 2“ (frequency 11.582 MHz, polarisation horizontal, sound subcarriers 7.38/7.56 MHz).

(For station parameters please also refer to the teletext information).

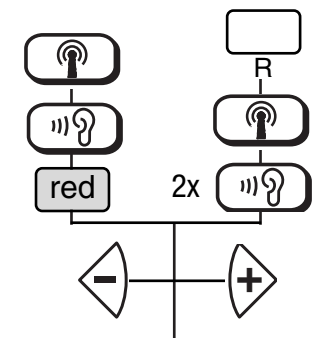
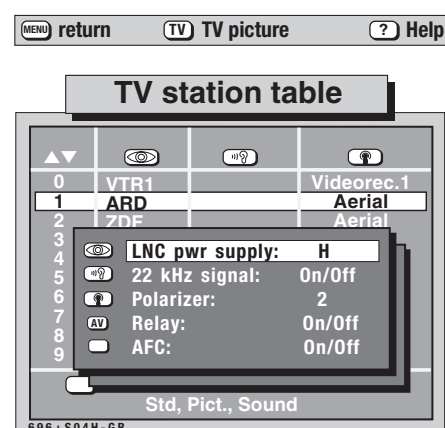
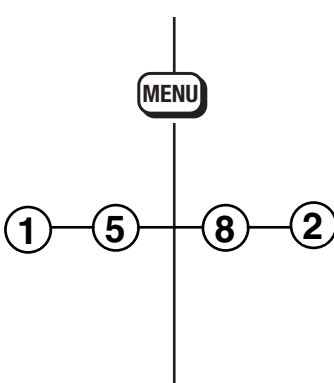
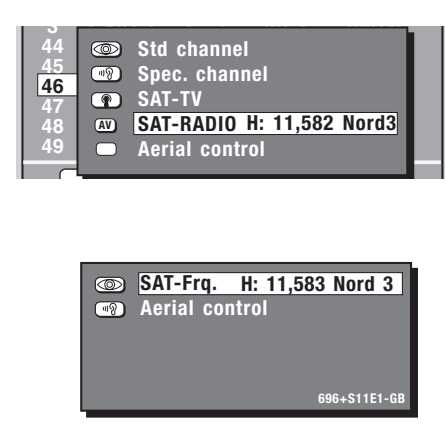
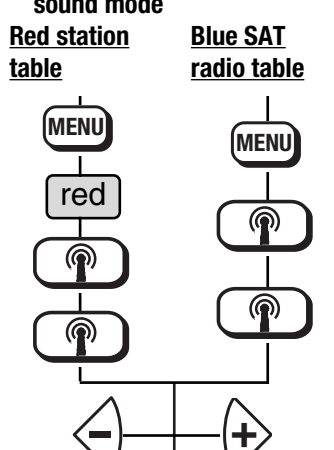
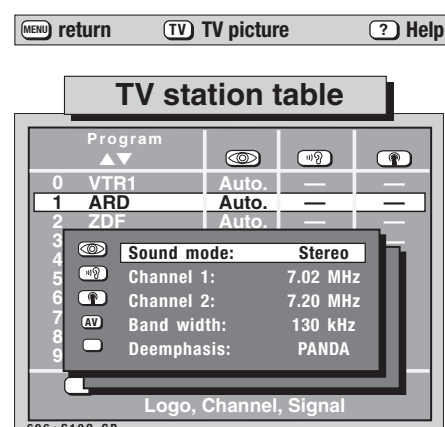
Press this key on the remote control	The screen displays	Explanation
<p>1. Select a SAT radio program position and set the LNC supply</p> <p>Red station table Blue SAT radio table</p> 		<p>In this menu, you must first set the polarisation for the desired station.</p> <p>In our example, the station NDR 2 uses horizontal polarisation.</p> <p>The polarisation can be selected with the $\leftarrow \rightarrow$ keys.</p> <p>The 22 kHz signal must be set to match the satellite being used, as described in step 3 on page 10.</p> <p>! If the station table with the blue header line now appears, see the instructions for Step 3.</p>
<p>2. Enter the station frequency</p> 		<p>The SAT radio station „NDR 2“ is a sound subcarrier of the TV station „Nord 3“ and is transmitted by the ASTRA satellite on the frequency 11.582 GHz.</p> <p>Back to the example: Enter 1 5 8 2 on the numerical keys.</p> <p>After you have entered the frequency, the TV program from the station „N3“ appears behind the menu on the screen.</p> <p>The menu for frequency input may differ, depending on the model, as shown in the picture.</p>
<p>3. Call the submenu „SAT sound settings“ and set the sound mode</p> <p>Red station table Blue SAT radio table</p> 		<p>In the submenu SAT sound settings, you can set all sound parameters required for a SAT radio station.</p> <p>These settings apply only to the currently selected program position.</p> <p>You can also select the sound mode in this menu. The possible settings are MONO, STEREO and DUAL (for dual-channel transmissions).</p>

10. SAT Radio Operation Programming radio stations

Press this key on the remote control

The screen displays

Explanation

4. Set the sound subcarrier frequency for radio

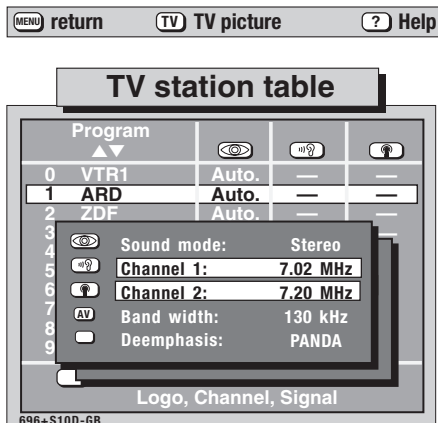
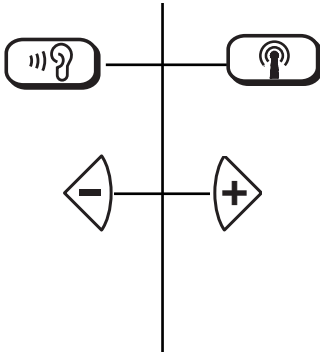

NDR 2 uses the sound subcarrier frequencies 7.38 MHz and 7.56 MHz. The most commonly used sound subcarrier frequencies can be selected by pressing the numerical keys, to which the following frequencies are assigned:

- | | | |
|------------|------------|------------|
| ① 6,20 MHz | ② 6,50 MHz | ③ 6,65 MHz |
| ④ 7,02 MHz | ⑤ 7,20 MHz | ⑥ 7,38 MHz |
| ⑦ 7,56 MHz | ⑧ 7,74 MHz | ⑨ 7,92 MHz |
| | ⑩ 8,10 MHz | |

You can also adjust the frequency in steps of 10 kHz in the range 5.00 MHz to 9.99 MHz with the aid of the \leftarrow \rightarrow keys. In the case of stereo stations, the frequency for sound channel 2 changes automatically as the frequency for sound channel 1 is adjusted, since these frequencies are always 180 kHz apart. After adjusting sound channel 1, you can then adjust sound channel 2 if necessary.

5. Set the „Bandwidth“

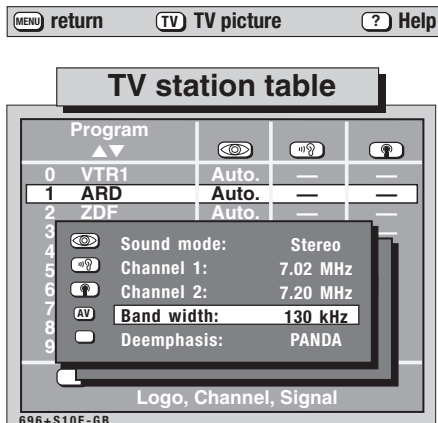
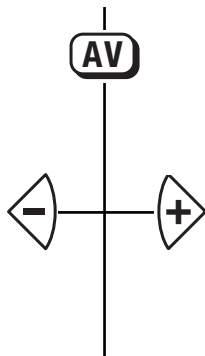

The preset default bandwidth for MONO stations is 280 kHz, while the default for STEREO and DUAL stations is 130 kHz.

These bandwidths are normally sufficient.

Note: always select 130 kHz for ASTRA subcarriers.

If the sound is distorted, try adjusting the bandwidth to obtain better reception.

6. Set the „Deemphasis“

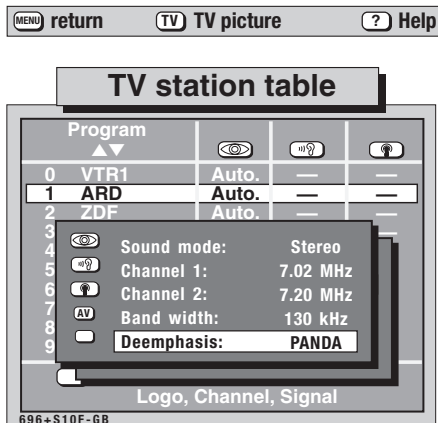
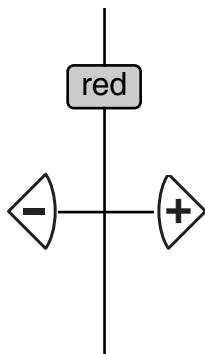

The deemphasis (a method used to reduce noise in the sound channel) improves the quality of the sound received from a SAT station.

You can select one of the following settings:

- Off
- 50µs
- 75 µs
- J17
- PANDA

Note: for ASTRA subcarriers, always select PANDA.

When you switch between **MONO**, **STEREO** and **DUAL**, the bandwidth and de-emphasise are automatically switched to the appropriate default values. Values for other settings can be found in the related tables in trade magazines.

7. Store the settings and close the menu



Once the settings have been stored and the menu cleared, the picture tube is switched off.









11. SAT-ADR Radio Operation

Programming ADR radio stations

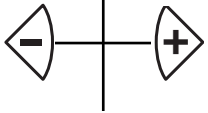
The ASTRA satellites also transmit ADR (ASTRA Digital Radio) programmes. The digital transmission of speech and music permits high-quality reception because the signals are not subject to interference. Some ADR stations are already programmed in the factory (see the SAT station table „ASTRA ADR radio stations“). These stations can be programmed in the menu „SAT programme assignments“ (see Section 1) if your TV set **is equipped with the ADR upgrade kit**.

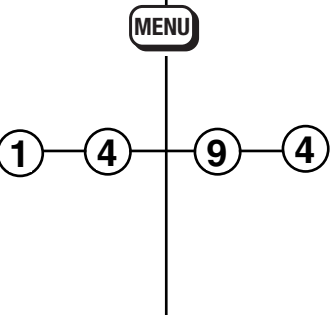
Proceed as follows if you wish to programme a new station that is not listed in the SAT station table.

Example: You want to programme the SAT ADR station „hr 3“ (frequency 11.494 MHz, horizontal polarisation, sound subcarrier 7.92 MHz). (See teletext).

Press this key on the remote control	The screen displays	Explanation																				
<p>1. Select a SAT-ADR radio program position and set the LNC supply</p> <p>Red station table</p>  <p>Blue SAT radio table</p>  	<p>MENU return TV TV picture ? Help</p> <p>TV station table</p> <table border="1"> <thead> <tr> <th>Program</th> <th>Std.</th> <th>Pict.</th> <th>Sound</th> </tr> </thead> <tbody> <tr> <td>0 VTR1</td> <td>00</td> <td></td> <td>Videorec.1</td> </tr> <tr> <td>1 ARD</td> <td>06</td> <td></td> <td>Aerial</td> </tr> <tr> <td>2 7DF</td> <td>34</td> <td></td> <td>Aerial</td> </tr> </tbody> </table> <p>LNC pwr supply: H 22 kHz signal: On/Off Polarizer: 2 Relay: On/Off AFC: On/Off</p> <p>Std, Pict., Sound</p> <p>696+S04H1-GB</p>	Program	Std.	Pict.	Sound	0 VTR1	00		Videorec.1	1 ARD	06		Aerial	2 7DF	34		Aerial	<p>In this menu, you must first set the polarisation for the desired station.</p> <p>In our example, the station „hr 3“ uses horizontal polarisation.</p> <p>The polarisation can be selected with the  keys.</p> <p>The 22 kHz signal must be set to match the satellite being used, as described in step 3 on page 10.</p> <p>! If the station table with the blue header line now appears, see the instructions for Step 3.</p>				
Program	Std.	Pict.	Sound																			
0 VTR1	00		Videorec.1																			
1 ARD	06		Aerial																			
2 7DF	34		Aerial																			
<p>2. Enter the station frequency</p> 	<p>Std channel Spec. channel Fine tuning SAT-Frq. H: 11,494 ARD Aerial control</p> <p>SAT-Frq. H: 11,494 ARD Aerial control</p> <p>696+S11E2-GB</p>	<p>The SAT radio station „hr 3“ is a sound subcarrier of the TV station „ARD“ and is transmitted by the ASTRA satellite on the frequency 11.494 GHz.</p> <p>Back to the example: Enter 1 4 9 4 on the numerical keys.</p> <p>After you have entered the frequency, the TV program from the station „ARD“ appears behind the menu on the screen.</p> <p>The menu for frequency input may differ, depending on the model, as shown in the picture.</p>																				
<p>3. Call the sub-menu „SAT sound settings“ and set the sound transmission method</p> <p>Red station table</p>  <p>Blue SAT radio table</p>  	<p>MENU return TV TV picture ? Help</p> <p>Radio station table</p> <table border="1"> <thead> <tr> <th>Program</th> <th>Std.</th> <th>Pict.</th> <th>Sound</th> </tr> </thead> <tbody> <tr> <td>40 BREM2</td> <td>Auto.</td> <td>—</td> <td>ADR</td> </tr> <tr> <td>41 SR1</td> <td>Auto.</td> <td>—</td> <td>ADR</td> </tr> <tr> <td>42 NDR 2</td> <td>Auto.</td> <td>—</td> <td>ADR</td> </tr> <tr> <td>43 NDR 4</td> <td>Auto.</td> <td>—</td> <td>ADR</td> </tr> </tbody> </table> <p>Volume adjustm. +00 Muting Off Adj. SAT sound ADR / FM ADR</p> <p>Std, Pict., Sound</p> <p>696+S11B-GB</p>	Program	Std.	Pict.	Sound	40 BREM2	Auto.	—	ADR	41 SR1	Auto.	—	ADR	42 NDR 2	Auto.	—	ADR	43 NDR 4	Auto.	—	ADR	<p>If your TV set is equipped with an ADR upgrade kit, it will ask you to select either ADR or FM as the sound transmission method.</p> <p>ADR/FM is displayed only if an ADR program position was selected in Step 1.</p> <p>ADR must be selected for digital sound transmission (possible only with the ADR upgrade kit).</p> <p>FM is selected for analogue sound transmission (normal radio).</p> <p>When this menu line is active, you can switch between ADR and FM with the  keys.</p> <p>ADR must be selected for an ADR station.</p>
Program	Std.	Pict.	Sound																			
40 BREM2	Auto.	—	ADR																			
41 SR1	Auto.	—	ADR																			
42 NDR 2	Auto.	—	ADR																			
43 NDR 4	Auto.	—	ADR																			

11. SAT-ADR Radio Operation

Programming ADR radio stations

Press this key on the remote control

The screen displays

Explanation

4. Call sub-menu „SAT sound settings“ and set the sound mode



[MENU] return [TV] picture [?] Help

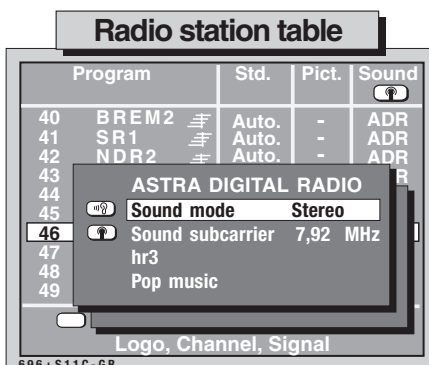

In this menu, you can set all parameters which are needed for a SAT-ADR station.

These settings apply only to the currently selected programme position.

You can select either **STEREO, MONO A** or **MONO B** mode.

MONO A/B: you can select one of two MONO stations transmitted on the selected subcarrier.

5. Set the sound subcarrier frequency for radio



[MENU] return [TV] picture [?] Help

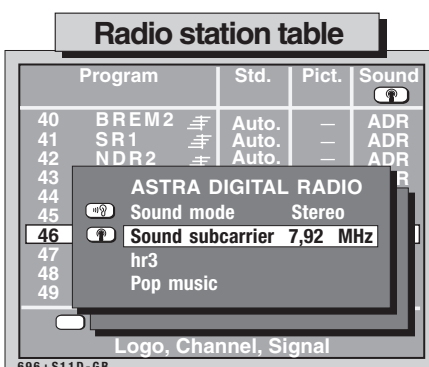

As shown in the station table, „hr 3“ uses the sound subcarrier frequency 7.92 MHz.

The most commonly used sound subcarrier frequencies can be selected by pressing the numerical keys, to which the following frequencies are assigned:

- ① 6,12 MHz ② 6,30 MHz ③ 6,48 MHz
- ④ 6,66 MHz ⑤ 6,84 MHz ⑥ 7,74 MHz
- ⑦ 7,92 MHz ⑧ 8,10 MHz ⑨ 8,28 MHz
- ⑩ 8,46 MHz

You can also adjust the frequency in steps of 10 kHz in the range 5.00 MHz to 9.99 MHz with the aid of the \leftarrow \rightarrow keys.

6. Store the settings and close the menu

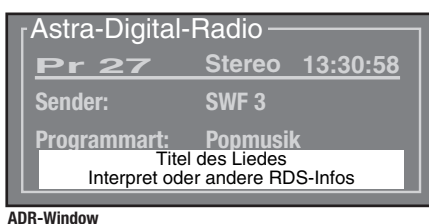

ADR-Window

Once the settings have been stored and the menu cleared, the picture tube is switched off.

It can be switched on again to display the station logo by pressing the [TV] key.

The info-box which is then displayed shows the programme position, the sound mode, the time, the station name and the type of programme.

This info-box can be displayed and cleared with the [TV] key, which also switches the picture tube on and off.

The white box displays the radio text.

This is transmitted by some stations and provides additional information such as the title being played and name of the artist.

14. Program position management for SAT stations

If a TV set with 225 program positions is fitted with a SAT upgrade kit 081 NB 1010 or 083 NB 1018, a separate operating level for SAT radio stations is added to the menus.

The number of TV stations which can be stored in the TV station table then depends on the number of SAT radio stations stored in the radio station table and vice versa.

Basically, the TV set offers:

- 225 program positions exclusively for TV stations and no program positions for radio stations
or
- 33 program positions for TV stations and 256 program positions for radio stations
or
- a variable combination of the two, as shown in the table below.

TV station table

SAT radio station table

Press the „R“ key to switch between the two station tables.

Red header

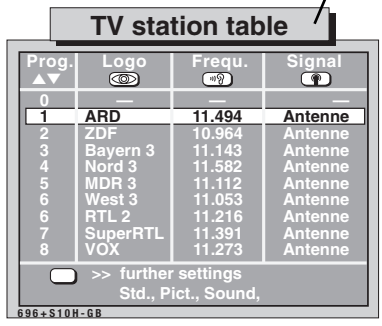

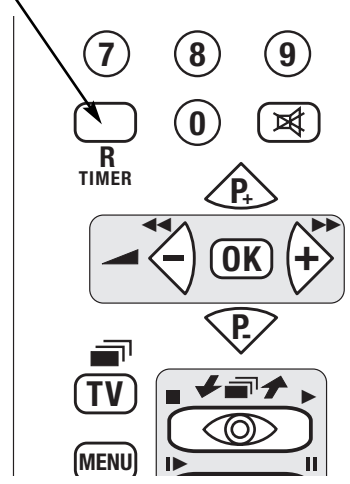

Blue header

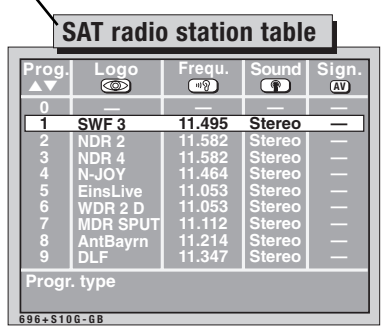

Number of TV program positions:

Number of program positions for SAT radio stations

225	0
200	33
175	66
150	100
125	133
100	166
75	200
50	233
33	256

Intermediate values not shown in the table can be calculated with the following formula:

$$\frac{3600 - (n_{TV} \times 16)}{12} = n_{Radio}$$

(n = number of stations)



Televisions sets

Quality – A matter of principle.

With the trend-setting Metz technology you will always make the correct choice. See your Metz dealer. He will be happy to demonstrate the



Video recorders



mecablitz electronic flashguns



Camcorders



Metz-Werke GmbH & Co KG
Postfach 2035, D-90710 Fürth

Availability and technical
details subject to change
without notice

Printed in Germany



Always first class!

© 696 47 2037