



KONICA MINOLTA

DYNAX MAXXUM 5 *D*



 INSTRUCTION MANUAL

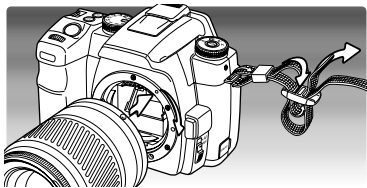

QUICK START CHECK LIST

The following sections will get you started in enjoying your camera.

Attach a lens (p. 18) and the camera strap (p. 19).
Adjust the viewfinder diopter if necessary (p. 19).

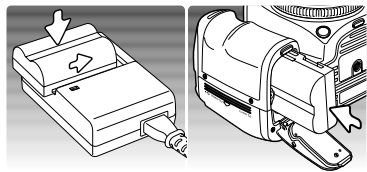

Charge the battery (p. 20) and insert it into the camera (p. 21).

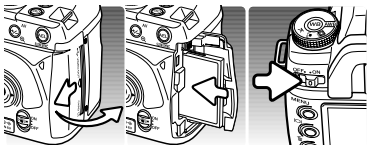

Insert a memory card into the camera (p. 24). Turn on the camera and set the date and time (p 26).



To take a picture, see the basic recording operation section on page 28. To use the flash, see page 31.



To playback recorded images, see page 34.



To delete an image, see page 36.



To connect the camera to a computer to download images, see page 115. CAUTION: when using a Windows 98 or 98SE operating system, the supplied driver software must be installed, see page 116. To install Kodak EasyShare software, see page 132. To install DiIMAGE Master Lite, see page 134.



For basic problems, see the troubleshooting section on page 136.

BEFORE YOU BEGIN

Thank you for purchasing this Konica Minolta digital camera. Please take the time to read through this instruction manual so you can enjoy all the features of your new camera.

Check the packing list before using this product. If any items are missing, immediately contact your camera dealer.

Maxxum/Dynax digital camera
Lithium-ion battery NP-400
Lithium-ion battery charger BC-400
Wide Strap WS-5
Video Cable VC-500

USB Cable USB-3
Digital Camera Software CD-ROM
Camera instruction manual
Warranty card

This product is designed to work with accessories manufactured and distributed by Konica Minolta. Using accessories or equipment not endorsed by Konica Minolta may result in unsatisfactory performance or damage to the product and its accessories.

Only use the battery specified in this manual that are manufactured and distributed by Konica Minolta. Beware of counterfeit batteries; the use of these batteries will damage the product and may cause fire.

This manual contains information on products and accessories available at the time of printing. To obtain compatibility information on products not contained in this manual, contact a Konica Minolta service facility.

Konica Minolta is a trademark of Konica Minolta Holdings, Inc. Maxxum, Dynax, and DiMAGE are trademarks of Konica Minolta Photo Imaging, Inc. Apple, Macintosh, and Mac OS are registered trademarks of Apple Computer Inc. Microsoft and Windows are registered trademarks of the Microsoft Corporation. The official name of Windows is Microsoft Windows Operating System. Microdrive is a trademark of Hitachi Global Storage Technologies. Adobe is a registered trademark of Adobe Systems Incorporated. EasyShare is a registered trademark or trademark of the Eastman Kodak Company in the United States and other countries. All other brand and product names are trademarks or registered trademarks of their respective owners.

FOR PROPER AND SAFE USE

NP-400 LITHIUM-ION BATTERIES

This camera operates on a powerful lithium-ion battery. Misuse or abuse of the lithium-ion battery can cause damage or injury through fire, electric shock, or chemical leakage. Read and understand all warnings before using the battery.

DANGER

- Do not short, disassemble, damage, or modify the battery.
- Do not expose the battery to fire or high temperatures over 60°C (140°F).
- Do not expose the battery to water, or moisture. Water can corrode or damage the internal battery safety devices and cause the battery to overheat, ignite, rupture, or leak.
- Do not drop or subject the battery to strong impacts. Impacts can damage the internal battery safety devices and cause the battery to overheat, ignite, rupture, or leak.
- Do not store the battery near or in metallic products.
- Do not use the battery with any other products.
- Only use the specified charger. An inappropriate charger may cause damage or injury through fire or electric shock.
- Do not use a leaking battery. If fluid from the battery enters your eye, immediately rinse the eye with plenty of fresh water and contact a doctor. If fluid from the battery makes contact with your skin or clothing, wash the area thoroughly with water.
- Only use or charge the battery in an environment with ambient temperatures between 0° and 40°C (32° and 104°F). Only store the battery in an environment with ambient temperatures between -20° and 30°C (-4° and 86°F) and a humidity of 45% to 85% RH.

WARNING

- Tape over the lithium-ion battery contacts to avoid short-circuiting during disposal; always follow local regulations for battery disposal.
- If charging is not completed after the specified period elapses, unplug the charger and discontinue charging immediately.

GENERAL PRODUCT WARNINGS AND CAUTIONS

Read and understand the following warnings and cautions for safe use of the digital camera and its accessories.

WARNING

- Only use the battery specified in this manual.
- Only use the specified charger or AC adapter within the voltage range indicated on the unit. An inappropriate adapter or current may cause damage or injury through fire or electric shock.
- Only use the charger power cord in the sales region for which it was designed. An inappropriate current may cause damage or injury through fire or electric shock.
- Do not disassemble the camera or charger. Electric shock may cause injury if a high voltage circuit inside the product is touched.
- Immediately remove the battery or unplug the AC adapter and discontinue use if the camera is dropped or subjected to an impact in which the interior, especially the flash unit, is exposed. The flash has a high voltage circuit which may cause an electric shock resulting in injury. The continued use of a damaged product or part may cause injuries or fire.
- Keep the battery, memory card, or small parts that could be swallowed away from infants. Contact a doctor immediately if an object is swallowed.
- Store this product out of reach of children. Be careful when around children not to harm them with the product or parts.
- Do not fire the flash directly into the eyes. It may damage eyesight.
- Do not fire the flash at vehicle operators. It may cause a distraction or temporary blindness which may lead to an accident.
- Do not use the monitor while operating a vehicle or walking. It may result in injury or an accident.
- Do not look at the sun or strong light sources through the viewfinder or lens. It may damage your eyesight or cause blindness.

- Do not use these products in a humid environment, or operate them with wet hands. If liquid enters these products, immediately remove the battery or unplug the product, and discontinue use. The continued use of a product exposed to liquids may cause damage or injury through fire or electric shock.
- Do not use these products near inflammable gases or liquids such as gasoline, benzine, or paint thinner. Do not use inflammable products such as alcohol, benzine, or paint thinner to clean these products. The use of inflammable cleaners and solvents may cause an explosion or fire.
- When unplugging the AC adapter or charger, do not pull on the power cord. Hold the plug when removing it from an outlet.
- Do not damage, twist, modify, heat, or place heavy objects on the AC adapter or charger cord. A damaged cord may cause damage or injury through fire or electric shock.
- If these products emits a strange odor, heat, or smoke, discontinue use. Immediately remove the battery taking care not to burn yourself as the battery may become hot with use. The continued use of a damaged product or part may cause injuries or fire.
- Take the product to a Konica Minolta service facility when repairs are required.
- Handling the cord on this product may expose you to lead, a chemical known to the State of California to cause cancer, and birth defects or other reproductive harm. Wash hands after handling.

CAUTION

- Do not point a photographic lens directly at the sun. If sunlight is focused on an inflammable surface, a fire may result. Replace the lens cap when the lens is not in use.
- Do not use or store these products in a hot or humid environment such as the glove compartment or trunk of a car. It may damage the camera, charger, and battery which may result in burns or injuries caused by heat, fire, explosion, or leaking battery fluid.
- If the battery is leaking, discontinue use of the product.
- The camera, charger, and battery temperature rises with extended periods of use. Care should be taken to avoid burns.
- Burns may result if the memory card or battery is removed immediately after extended periods of use. Turn the camera off and wait for it to cool.
- Do not fire the flash while it is in contact with people or objects. The flash unit discharges a large amount of energy which may cause burns.
- Do not apply pressure to the LCD monitor. A damaged monitor may cause injury, and the liquid from the monitor may cause inflammation. If liquid from the monitor makes contact with skin, wash the area with fresh water. If liquid from the monitor comes in contact with the eyes, immediately rinse the eyes with plenty of water and contact a doctor.
- When using the AC adapter and charger, insert the plug securely into the electrical outlet.
- Do not use electronic transformers or travel adapters with the charger. The use of these devices may cause a fire or damage the product.
- Do not use if the AC adapter or charger cord is damaged.
- Do not cover the AC adapter or charger. A fire may result.
- Do not obstruct access to the AC adapter or charger; this can hinder the unplugging of the units in emergencies.
- Unplug the AC adapter or charger when cleaning or not in use.

TABLE OF CONTENTS

Quick start check list	2
Before you begin	3
For proper and safe use.....	4
Names of parts	14
Camera body	14
Recording mode display.....	16
Viewfinder.....	17
Getting up and running.....	18
Attaching and removing a lens	18
Attaching the camera strap	19
Diopter adjustment	19
Charging the battery.....	20
Installing and changing the battery	21
Turning on the camera	22
AC Adapter AC-11 (sold separately)	22
Battery condition indicator	23
Auto power save.....	23
Inserting and changing a memory card.....	24
Setting the date and time	26
Basic recording.....	27
Setting the camera to record images automatically	27
Handling the camera	27
Basic recording display	27
Basic recording operation.....	28
Focus signals	29
Special focusing situations	29
Focus lock	30
Camera-shake warning	30
Using the built-in flash.....	31
Anti-Shake system	32
Display button.....	33
Basic playback	34
Viewing images	34
Rotating images	34

Histogram display	35
Deleting single images	36
Changing the playback display	37
Enlarged playback	38
Advanced recording	39
Exposure-mode dial	39
Digital Subject Programs.....	40
Auto Recording.....	41
Program - P	41
Aperture priority - A	42
Shutter priority - S	42
Exposure control range warnings.....	43
Manual exposure - M	44
Bulb exposures.....	45
Exposure lock - AEL button	46
Slow sync.	47
Spot AF button.....	47
Exposure compensation	48
Depth-of-field preview	49
AF / MF switch	49
Drive modes	50
Continuous-advance notes.....	51
Self-timer notes	51
Exposure bracketing notes.....	52
White-balance bracketing notes.....	53
Camera sensitivity (ISO) and Zone Matching	54
Camera sensitivity and flash range	55
Function button.....	56
AF area.....	57
AF modes	58
Metering modes.....	59
Flash compensation	60
Color mode.....	61
Digital Effects Control (DEC).....	63

White balance.....	64
Auto white balance.....	64
Preset white balance.....	65
Custom white balance.....	66
Color temperature.....	67
A short guide to photography.....	68
Light sources and color.....	69
What is an Ev?.....	69
Recording menu.....	70
Navigating the recording menu.....	70
Image size and image quality.....	72
Instant playback.....	74
Noise reduction.....	74
Flash modes.....	75
Wireless/Remote flash.....	76
Wireless/Remote camera and flash ranges.....	78
Flash control.....	79
Bracketing order.....	80
Recording mode reset.....	80
About DiMAGE Master.....	81
Playback menu.....	82
Navigating the playback menu.....	82
Frame-selection screen.....	83
Delete.....	84
Format.....	85
View folder.....	85
Lock.....	86
Index playback format.....	87
Slide Show.....	88
About DPOF.....	88
DPOF setup.....	89
Date imprint.....	90
Index print.....	90
Cancel print.....	90
Opening the custom & setup menus.....	91

Custom menu	92
AF / Shutter release priority setup	93
Focus-hold button setup	94
AEL button setup	94
Control-dial setup	95
Exposure-compensation setup	95
AF illuminator	96
Card shutter lock	96
Lens shutter lock	96
AF area setup	97
Monitor display setup	97
Recording display setup	97
Playback display setup	97
Setup menu	98
LCD brightness	100
Transfer mode	100
Video output	101
Viewing images on a television	101
Audio signals	102
Language	102
Date and time setup	103
File number (#) memory	103
Folder name	104
Select folder	104
New folder	105
LCD backlight	105
Auto power save	105
Menu section memory	106
Delete confirmation	106
Clean CCD	106
Reset default	108
Accessory notes	110
Lens compatibility	110
Lens shadowing	110
Focal-length conversion	110

CCD plane	110
Attaching the eyepiece cap.....	111
Viewfinder accessories	111
Attaching a remote cord.....	111
Attaching an accessory flash.....	112
Flash compatibility	112
High-Speed Sync. (HSS).....	112
PD Flash Adapter PCT-100	113
About the battery charger cord.....	113
Data-transfer mode.....	114
System requirements.....	114
Connecting the camera to a computer	115
Connecting to Windows 98 / 98 second edition	116
Automatic installation.....	116
Manual installation.....	117
Auto power save (Data-transfer mode)	119
Memory card folder organization.....	120
Disconnecting the camera from the computer	122
Windows 98 / 98 second edition	122
Windows Me, 2000 Professional, and XP.....	122
Macintosh	123
Changing the memory card (data-transfer mode).....	124
Windows 98 / 98 second edition	124
Windows Me, 2000 Professional, and XP.....	124
Macintosh	124
Removing the driver software - Windows	125
PictBridge	126
Notes on printing errors.....	127
Navigating the PictBridge menu.....	128
Batch print	129
Index print.....	129
Paper size	130
Layout.....	130
Print quality.....	131
Data print.....	131
DPOF print	131

Kodak EasyShare software	132
DiMAGE Master Lite.....	134
Troubleshooting.....	136
Care and storage.....	139
Camera care.....	139
Cleaning	139
Storage.....	139
Operating temperatures and conditions.....	140
Memory card care and handling.....	140
Batteries	140
LCD monitor care	141
Copyright	141
Before important events or journeys	141
Questions and service.....	141
Technical specifications.....	144
Index	146

NAMES OF PARTS

CAMERA BODY

* This camera is a sophisticated optical instrument. Care should be taken to keep these surfaces clean. Please read the care and storage instructions in the back of this manual (p. 139).

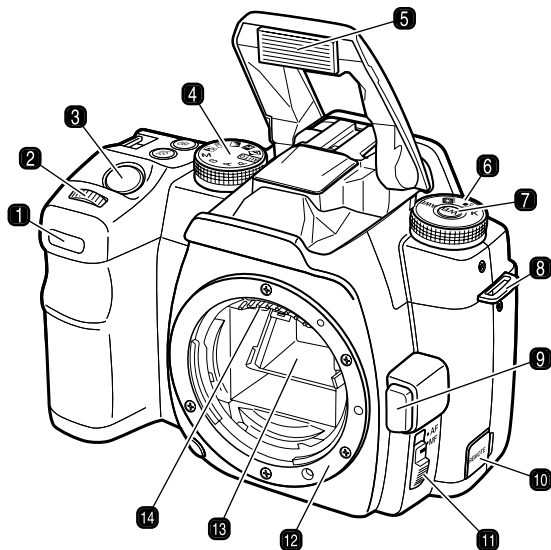
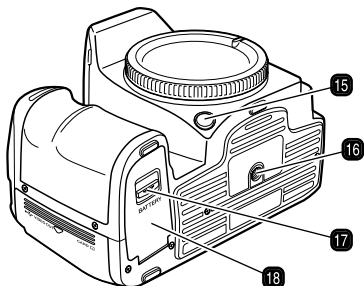

1. Self-timer lamp (p. 51)
2. Control dial
3. Shutter-release button
4. Exposure-mode dial (p. 39)
5. Flash* (p. 31)
6. White-balance dial (p. 64)
7. White-balance button (p. 64)
8. Strap eyelet (p. 19)
9. Lens release (p. 18)
10. Remote-control terminal (p. 111)
11. AF/MF switch (p. 49)
12. Lens mount
13. Mirror*
14. Lens contacts*
15. Depth-of-field preview button (p. 49)
16. Tripod socket
17. Battery-chamber release (p. 21)
18. Battery-chamber door (p. 21)

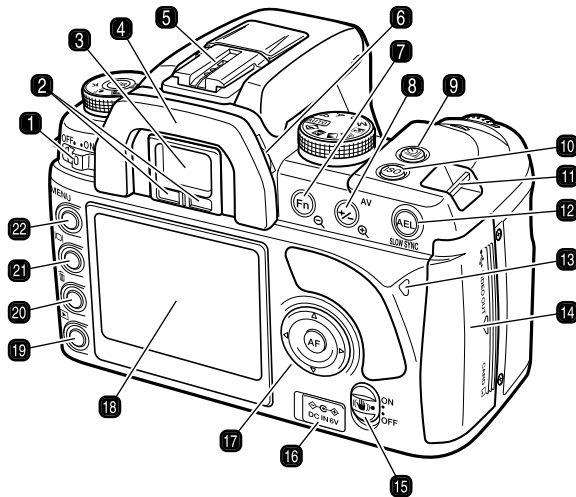

- | | |
|---|--|
| 1. Main switch | 13. Access lamp |
| 2. Eyepiece sensors* | 14. Card-slot / USB port / Video-out terminal door (p. 24, 115, 101) |
| 3. Viewfinder* (p. 17) | 15. Anti-Shake switch (p. 32) |
| 4. Eyepiece cup (p. 111) | 16. DC terminal (p. 22) |
| 5. Accessory shoe | 17. Controller & Spot-AF button (p. 47) |
| 6. Diopter-adjustment dial (p. 19) | 18. LCD monitor* (p. 16) |
| 7. Function button (p. 56) | 19. Playback button (p. 34) |
| 8. Exposure-compensation button (p. 48) | 20. Delete button (p. 36) |
| 9. Drive-mode button (p. 50) | 21. Display button (p. 33, 37) |
| 10. Camera-sensitivity (ISO) button (p. 54) | 22. Menu button |
| 11. Strap eyelet (p. 19) | |
| 12. AE lock button (p. 46) | |

RECORDING MODE DISPLAY

The recording display shows information on camera operation in panels. The information displayed varies with the functions set.

As the camera is rotated to a vertical position, the display automatically rotates to compensate for the camera position.

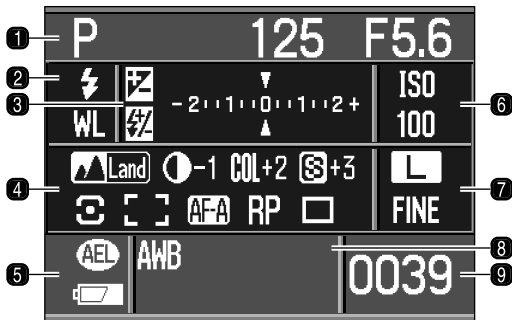

1. Exposure mode / exposure panel
2. Flash panel
3. Ev scale
4. Color mode / Digital Effects Control / Metering / AF area / AF mode / Release priority / Drive mode panel
5. AE lock / battery condition panel
6. Camera-sensitivity / Zone Matching panel
7. Image size / quality panel
8. White-balance panel
9. Frame counter



Camera Notes

The monitor-display setup and recording-display setup custom functions in section 2 of the custom menu control the monitor display (p. 97).

VIEWFINDER

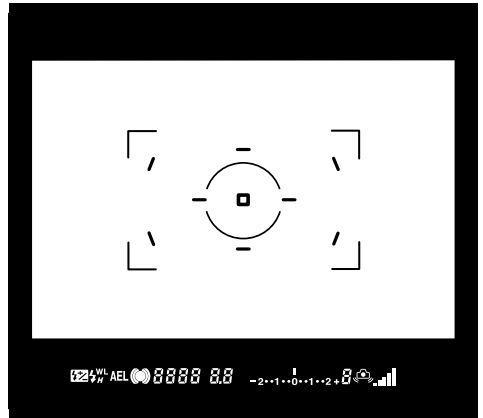
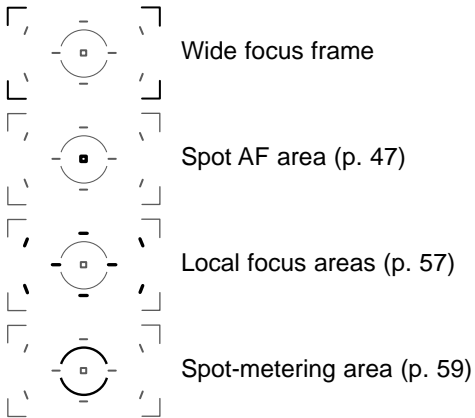

The spot AF area and local focus areas are illuminated briefly to indicate the point of focus when the focus is locked.



1. Flash-compensation indicator (p. 60)
2. Flash signal (p. 31)
3. High-speed sync. indicator (p. 112)
4. Wireless/Remote flash indicator (p. 76)
5. AE lock indicator (p. 46)
6. Focus signal (p. 29)
7. Shutter-speed display
8. Aperture display
9. Ev scale
10. Frames-remaining counter
11. Camera-shake warning (p. 30)
12. Anti-Shake scale (p. 32)

The frames-remaining counter indicates the approximate number of frames that can be stored in the camera buffer memory while recording. This number changes as images are captured and saved to the memory card.

GETTING UP AND RUNNING

This section covers the preparation of the camera. This includes the changing of batteries, memory cards, and lenses as well as the use of external power supplies.

ATTACHING AND REMOVING A LENS



This camera uses interchangeable lenses. See page 110 for compatible lenses. Never touch the inside of the camera, especially the lens contacts and mirror. Do not leave the interior of the camera exposed to dust or dirt. Replace the caps on the lens and attach the body cap or another lens to the camera as soon as possible. Check the body cap or lens is free from dust before mounting.

Remove the body cap from the camera and the rear cap from the lens.

Align the red mounting index on the lens and camera body. Carefully insert the lens into the mount, then turn it clockwise until it clicks into the locked position. Do not insert the lens at an angle. If it does not fit, check its orientation with the index marks. Never force the lens.

Press the lens release all the way in and turn the lens counter-clockwise until it stops. Carefully remove the lens.

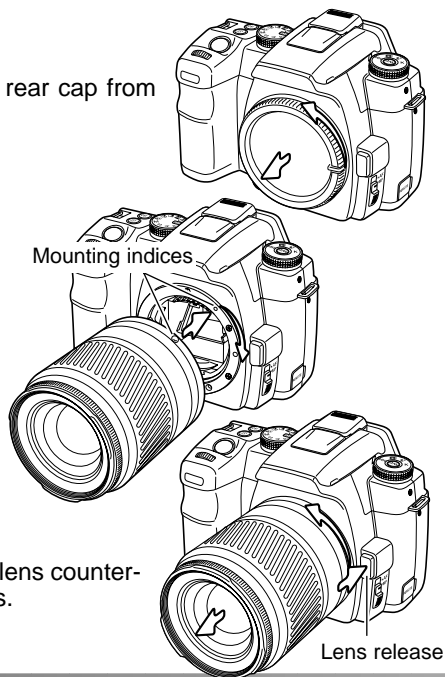

ATTACHING THE CAMERA STRAP

Always keep the camera strap around your neck in the event that you drop the camera.

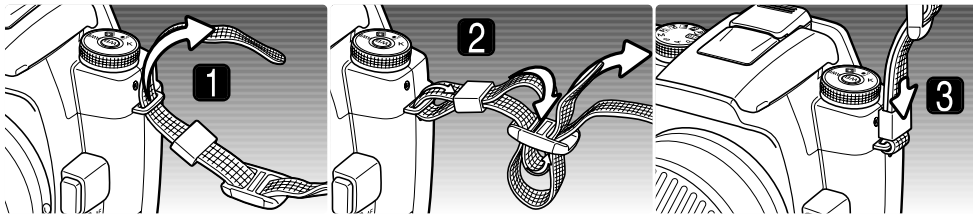

1. Pass the tip of the strap through the camera's strap eyelet from below. Attach the strap so the tip comes between the strap and the camera.
2. Thread the tip of the strap through the holder ring and the inside of the buckle and pull to tighten. Leave some slack in the camera strap so the tip may be threaded through the buckle easily.
3. Push the holder ring toward the strap eyelet to secure the strap to the camera. Repeat with the other end of the camera strap.

DIOPTER ADJUSTMENT

The viewfinder has a built-in diopter that can be adjusted between -2.5 to $+1.0$. While looking through the viewfinder, turn the diopter-adjustment dial until the viewfinder focus frame is sharp.

The optional Eyepiece Corrector 1000 series diopters can be used if the adjustable viewfinder diopter is not sufficient.

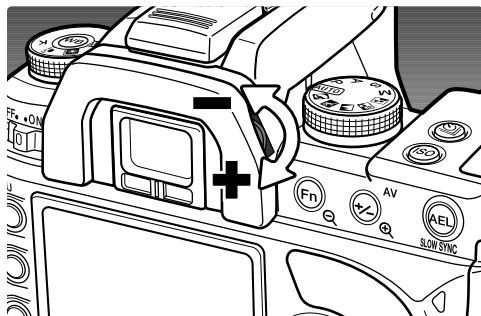

CHARGING THE BATTERY

Before the camera can be used, the lithium-ion battery must be charged. Before charging the battery, read the safety warnings on page 4 of this manual. Only recharge the battery with the supplied battery charger. The battery should be recharged before each shooting session. See page 140 for battery care and storage.

Plug the power cord into the back of the charger unit (1). Plug the other end of the cord into a live household outlet. The included AC cord is designed for the current of the sales region. Only use the cord in the region it was purchased. For more on the AC cable, see page 113.

With the battery contacts toward the charger, align the channels on the bottom of the battery with the tabs on the charger unit. Slide the battery into the unit.

The indicator lamp (2) glows to show the battery is charging. The lamp goes out when the battery is charged. Charging time is approximately 150 minutes.

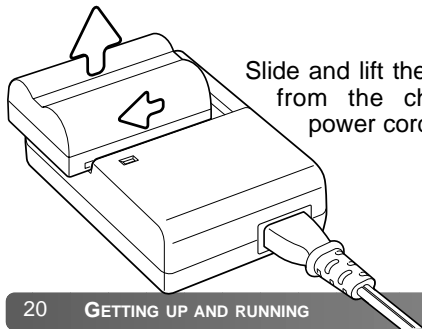
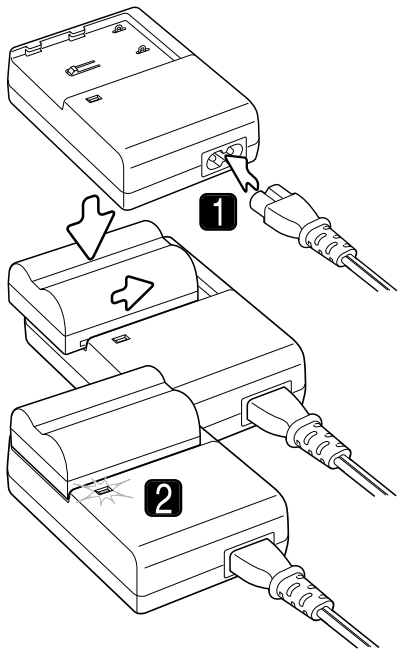

Slide and lift the battery to remove it from the charger. Unplug the power cord from the outlet.

INSTALLING AND CHANGING THE BATTERY

This digital camera uses one NP-400 lithium-ion battery. Before using the battery, read the safety warnings on pages 4 of this manual. When replacing batteries, the camera should be off.

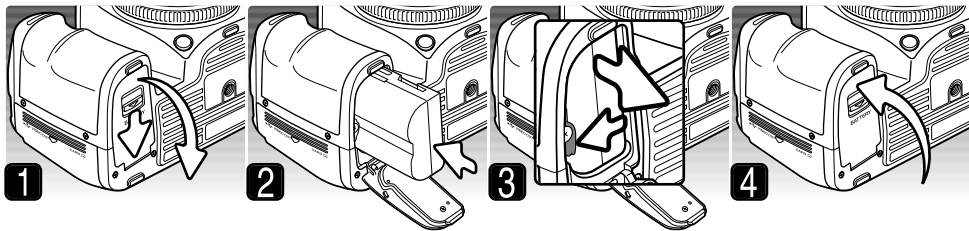

1. Open the battery-chamber door by sliding the battery-chamber release toward the back of the camera.
2. Insert the battery with the battery contacts first. Push the battery into the chamber until the battery latch clicks into place.
3. To remove a battery, slide the battery latch to the side of the battery chamber; the battery springs out.
4. Close the battery-chamber door until it clicks shut.

TURNING ON THE CAMERA

Slide the main switch to the on position to turn on the camera. The access lamp glows briefly to indicate the power is on. When the camera is initially turned on, the date and time should be set, see page 26. When not in use, turn the camera off to conserve power.

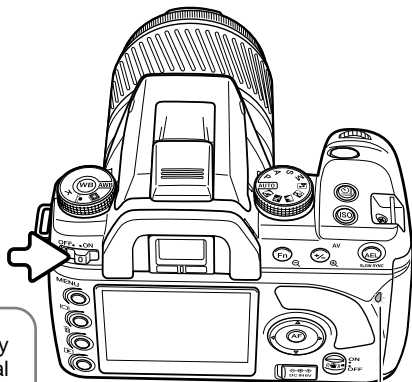

Access lamp

Camera Notes

Each time the camera is turned on, it automatically focuses the lens to the infinity position, even in manual focus. This operation is necessary to ensure proper exposures.

AC ADAPTER AC-11 (SOLD SEPARATELY)

The AC Adapter AC-11 allows the camera to be powered from an electrical household outlet. The AC Adapter is recommended when the camera is interfaced with a computer or during periods of heavy use.



Always turn off the camera and confirm the access lamp is not lit before changing between power supplies.

Open the DC terminal cover from the left. The cover is attached to the body to prevent loss.

Insert the mini plug of the AC adapter into the DC terminal.

Insert the AC adapter plug into an electrical outlet.

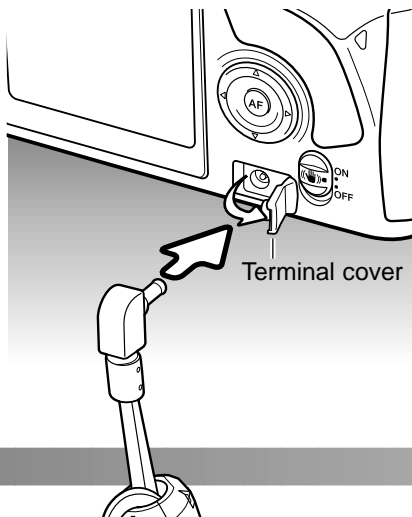

BATTERY CONDITION INDICATOR



This camera is equipped with an automatic battery-condition indicator. When the camera is on, the indicator appears on the monitor. The indicator changes from white to red when battery power is low. Not all camera functions are available if battery power is low. If the monitor is blank, the battery may be exhausted.



Full-battery indicator - the battery is fully charged.



Low-battery indicator - battery power is low. Recharge the battery.



Low-battery warning - battery power is very low. Recharge the battery.

When power falls below the level of the low-battery warning, the battery exhausted message appears just before the camera shuts down. The camera will not function until the battery is recharged.

AUTO POWER SAVE

To conserve battery power, the camera shuts down if an operation is not made within three minutes. To restore power, press the shutter-release button partway down. The length of the auto-power-save period can be changed in section 3 of the setup menu (p. 105).

The LCD monitor backlight turns off after five seconds. Press a camera button to restore the display. The length of this period can be changed in section 3 of the setup menu (p. 105).

INSERTING AND CHANGING A MEMORY CARD



Always turn off the camera and confirm the access lamp is not lit before inserting or removing a memory card, otherwise the card may be damaged, and data lost.

A memory card must be inserted for the camera to operate. If a card has not been inserted, “----” is displayed in the frame counter. Type I and II CompactFlash cards and Microdrives are compatible with this camera.

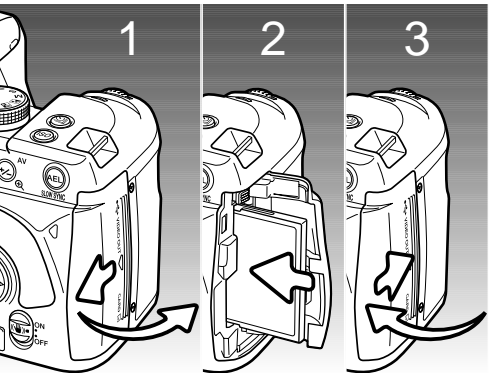

1. Slide the card-slot door toward the back of the camera to release the safety catch and open.
2. Insert a memory card all the way into the card slot. Insert the card so the face is toward the front of the camera. Always push the card in straight. Never force the card. If the card does not fit, check that it is oriented correctly.
3. Close the card-slot door and slide it toward the front of the camera to engage the safety catch.

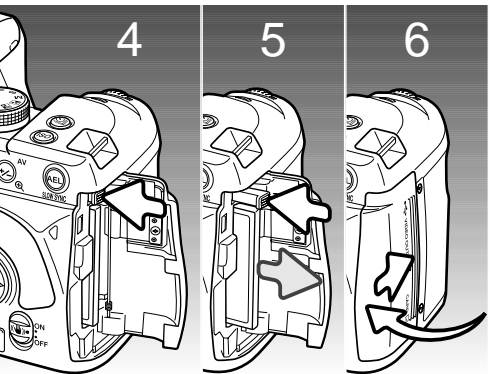

4. To eject a card, open the card-slot door, and press and release the card-eject lever to extend it.
5. Press the extended card-eject lever to eject the card. The card can now be pulled out. Take care when removing the card as it becomes hot with use. The card-eject lever should remain inside the camera body. If it extends, push it into the camera.
6. Insert a new memory card and close the card-slot door.

If the “Unable to use card, Format?” message appears, the card should be formatted with the camera. Use the right/left keys of the controller to highlight the yes button. Press the central button of the controller to format the card; this can take several minutes depending on the card. When a card is formatted, all the data on the card is permanently erased. Selecting “No” cancels the formatting operation; remove the card from the camera. A memory card used in another camera may have to be formatted before being used.



If the card-error message appears, press the central button of the controller to close the window; check the Konica Minolta web site for the latest compatibility information:

North America

<http://www.konicaminolta.us/>

Europe

<http://www.konicaminoltasupport.com>

SETTING THE DATE AND TIME

After initially inserting a memory card and battery, a message opens requesting that camera's clock and calendar be set. Images are recorded with the date and time of capture. Depending on the region, the menu language may also have to be set. To change the language, see the setup menu section on pages 98 and 102.

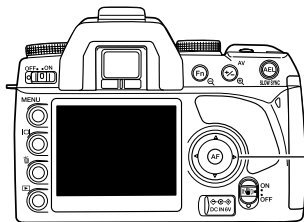

Turn on the camera.

Navigating the screen is simple. The up/down and left/right keys of the controller move the cursor and change settings. The central button of the controller sets adjustments.



Use the left and right controller keys to select "Yes." "No" cancels the operation.

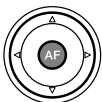

Press the central button of the controller to continue.

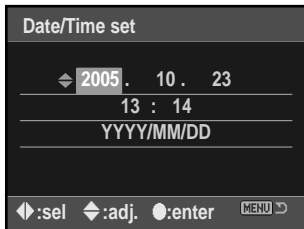

Use the left and right keys to select the item to be changed. The last item is the date format.



Use the up and down keys to adjust the item. The date format can be set among year/month/day, day/month/year, and month/day/year.

Date/Time setup screen

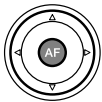

Press the central button to set the clock and calendar.

BASIC RECORDING

SETTING THE CAMERA TO RECORD IMAGES AUTOMATICALLY

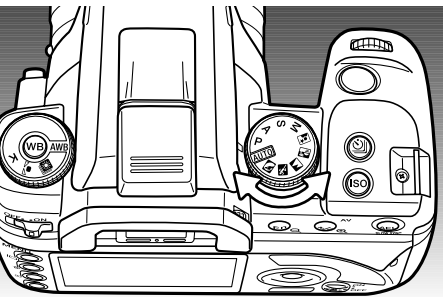

Turn the exposure dial to the auto or program (P) position. The camera controls are automatic.

Auto acts like the program mode, except that many of the recording functions are reset each time it is selected, see page 41 for more information. Not all function are available in auto recording such as the color mode and Digital Effects Control. The default camera sensitivity (p. 54) is auto for auto recording and ISO 100 for program.

HANDLING THE CAMERA

Grip the camera firmly with your right hand while supporting the body with the palm of your left hand. Keep your elbows at your side and your feet shoulder-width apart to hold the camera steadily. The use of a tripod or monopod is recommended when using the camera in low-light situations or when using telephoto lenses.



BASIC RECORDING DISPLAY

The viewfinder and monitor show the same indicators used in the basic recording operations.

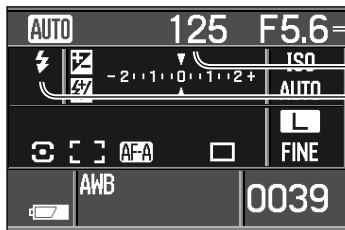

- Aperture
- Shutter-speed
- Flash indicator
- Anti-shake scale
- Focus signal
- Flash signal

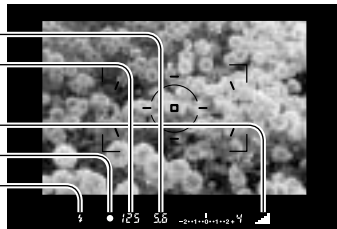

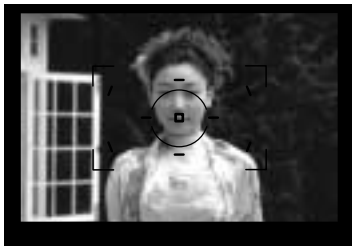

BASIC RECORDING OPERATION

Place the subject within the focus frame. The subject must be within the focus range of the lens. If using a zoom lens, change the focal length to frame the subject.

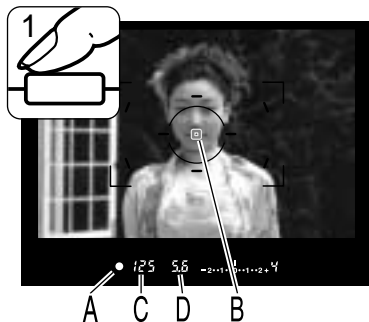

Press the shutter release button partway down to activate the autofocus and autoexposure systems (1). The viewfinder focus signal (A) confirms focus and the spot or local AF area (B) is illuminated briefly to indicate the point of focus. If the focus signal blinks, repeat the procedure.

The shutter speed (C) and aperture (D) used for the exposure are displayed in the viewfinder and on the monitor. For information on shutter speeds and f -numbers, see pages 43 and 55.

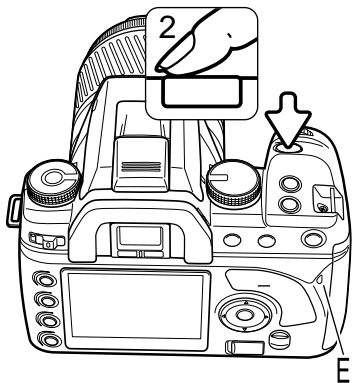

Press the shutter-release button all the way down (2) to take the picture. Press the shutter-release button gently so as not to shake the camera during the exposure.





The recorded image is displayed while the image is being saved. Press the shutter-release button partway down to cancel the playback. For more on instant playback, see page 74.

The access lamp (E) glows indicating the image data is being written to the memory card. Never remove a card while data is being transferred.

FOCUS SIGNALS

The viewfinder focus signal indicates the status of the autofocus system. Focusing time can be longer with macro or telephoto lenses, or in low-light conditions.



-  Focus locked.
-  Focus is confirmed (Continuous AF - p. 58).
-  Indicator blinks - cannot focus. The shutter is locked.
-  Focusing (Continuous AF). The shutter is locked.

When the camera cannot focus, the subject may be too close or a special focusing situation may be preventing the system from focusing. Use focus lock with an object at the same distance as the main subject (p. 30), focus the camera manually (p. 49), or raise the flash to use the AF illuminator (p. 96).

Autofocus priority and shutter-release priority can be specified in section 1 of the custom menu (p. 93).

SPECIAL FOCUSING SITUATIONS

The camera may not be able to focus in certain situations. Use focus lock or manual focus.



The subject is composed of repeating vertical lines.

The subject in the focus frame is low in contrast.

Two subjects at different distances overlap in the focus frame.

The subject is near a very bright object or area.

FOCUS LOCK

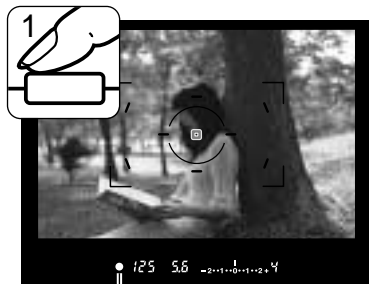

Focus signal

The focus-lock function is used when the subject is off-center and outside the focus frame. Focus lock may also be used when a special focusing situation prevents the camera from focusing on the subject.

Place the subject within the focus frame. Press and hold the shutter-release button partway down (1). The focus signals indicates that the focus is locked. When the focus is set, an AF area is illuminated briefly to indicate the point of focus.

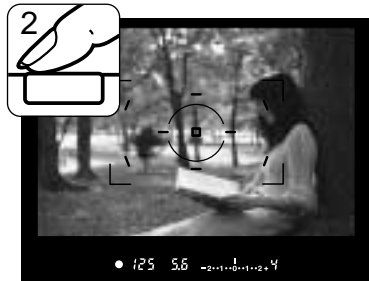

Without lifting your finger from the shutter-release button, recompose the subject within the viewfinder. Press the shutter-release button all the way down to take the picture (2).

CAMERA-SHAKE WARNING

If the shutter speed falls below the point where the camera can be hand held safely, the camera-shake warning indicator blinks in the viewfinder. Camera shake is slight blurring caused by subtle hand motion and is more pronounced with telephoto lenses than wide angle. Although the warning appears, the shutter can still be released. If the warning appears, place the camera on a tripod or use the built-in flash.



Camera-shake warning

USING THE BUILT-IN FLASH

The built-in flash is designed to be used with lenses with focal lengths from 18mm or longer. When using lenses shorter than 18mm, the corners of the image are not fully illuminated. The lens hood and certain lenses can cause shadowing, see page 110. The shutter will not release while the flash is charging.

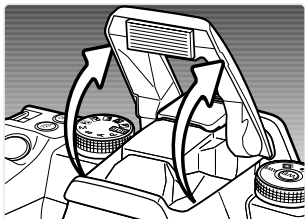

To use the flash, simply pull up the unit by the tabs on each side. The flash position must be set manually, and once up, the flash unit always fires regardless of the amount of ambient light. The flash mode is changed with the recording menu (p. 75).

Push down the built-in flash when the camera is not in use. The flash is also used as an AF illuminator, see page 96.

The viewfinder flash signal indicates the status of the flash.



 Signal steady - flash charged and ready to fire.

 Signal blinking - flash output was sufficient for exposure.

If the flash signal does not blink after taking the picture, the subject was not within the flash range. The flash range depends on the aperture used for the exposure. The follow chart shows the range when camera sensitivity is set to auto (auto recording) or ISO 100 (program). See page 55 for the flash range with other camera sensitivity settings.

Aperture	Auto ISO (Auto recording)	ISO 100 (Program exposure)
f/2.8	1.4 ~ 8.6m / 4.6 ~ 28ft.	1.0 ~ 4.3m / 3.3 ~ 14.ft.
f/3.5	1.1 ~ 6.8m / 3.6 ~ 22ft.	1.0 ~ 3.4m / 3.3 ~ 11.ft.
f/4.0	1.0 ~ 6.0m / 3.3 ~ 20ft.	1.0 ~ 3.0m / 3.3 ~ 9.8ft.
f/5.6	1.0 ~ 4.3m / 3.3 ~ 14ft.	1.0 ~ 2.1m / 3.3 ~ 6.7ft.

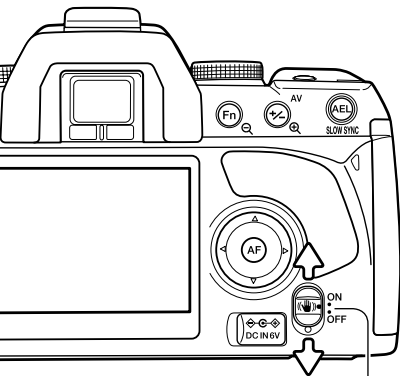

Anti-shake switch

ANTI-SHAKE SYSTEM

The Anti-Shake system minimizes the affect of camera shake, a slight blurring caused by subtle hand motion. Camera shake is more pronounced at long focal lengths than short ones.

Anti-Shake is less effective with moving subjects or when the camera is panned, with shutter speeds of 1/4 second or longer, and short object distances. Anti-shake is disabled with bulb exposures (p. 45).

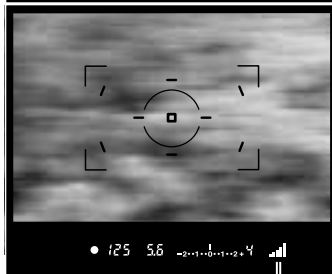
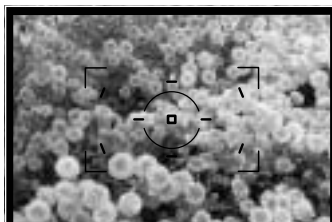

Anti-shake scale

When the system is active, the Anti-Shake scale in the viewfinder glows. Anti-Shake is turned off and on with the Anti-shake switch.

Frame the subject as described in the basic operation section. Press the shutter-release button partway down to focus and set the exposure.

The Anti-Shake scale indicates the degree of stabilization. The greater the scale displayed, the more unstable the image. Confirm the image has stabilized with the scale and press the shutter-release button all the way down to take the picture.

Anti-shake cannot be used with some lenses, see page 110. Turn Anti-Shake off when the camera is mounted on a tripod. The metered exposure may change when turning this function on and off.

DISPLAY BUTTON

Press the display button to switch the monitor display among full, basic, and off. For more on the full display, see page 16.

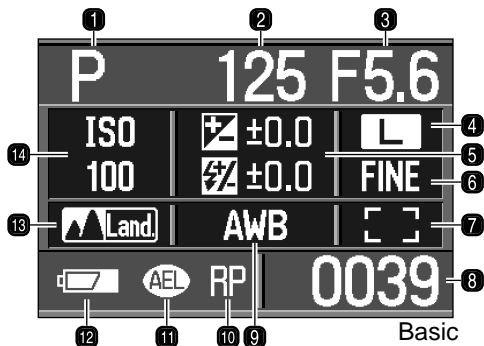

1. Exposure mode (p. 39)
2. Shutter speed display
3. Aperture display
4. Image-size display (p. 72)
5. Exposure/Flash compensation display (p. 48, 60)
6. Image-quality display (p. 72)
7. AF area display (p. 57)
8. Frame counter (p. 73)
9. White-balance display (p. 64)
10. Release priority indicator (p. 93)
11. AE lock indicator (p. 46)
12. Battery condition indicator (p. 23)
13. Color-mode indicator (p. 61)
14. Camera-sensitivity display (p. 55)

The full display uses a scale to show the degree of flash and exposure compensation as well as the metered exposure value in manual exposure. The basic display uses a numerical value.

Turning off the display conserves battery power.

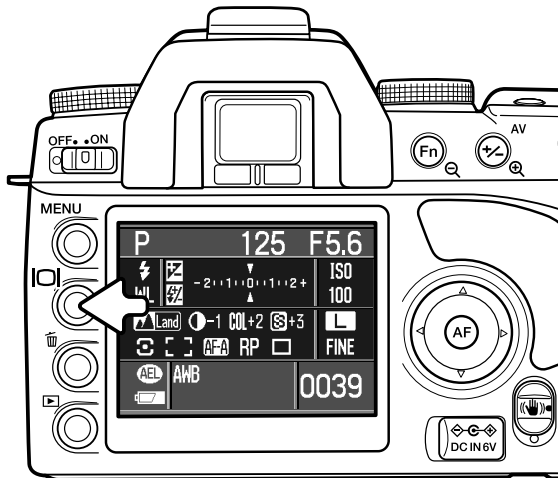

BASIC PLAYBACK

Images can be viewed in the playback mode. This section covers the basic playback functions. The playback mode has additional menu functions, see page 82.

VIEWING IMAGES

Press the playback button to activate the playback mode. To return to the recording mode, press the playback button or the shutter-release button.

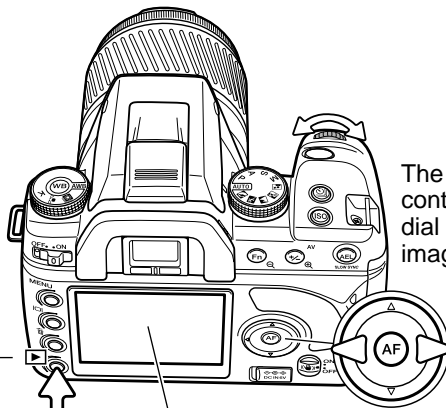

The left/right keys of the controller and the control dial display the recorded images.

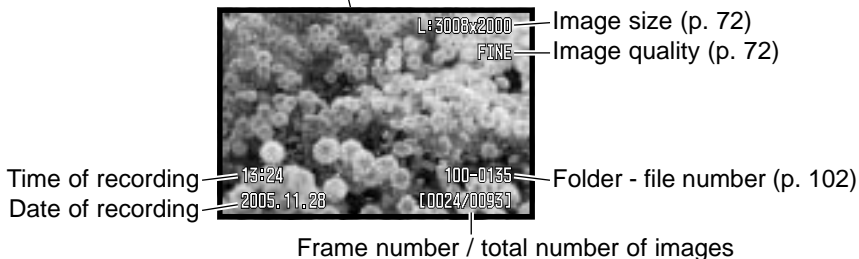

ROTATING IMAGES

Press the down key of the controller to rotate a displayed image 90° left, 90° right, or horizontally.

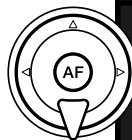

HISTOGRAM DISPLAY

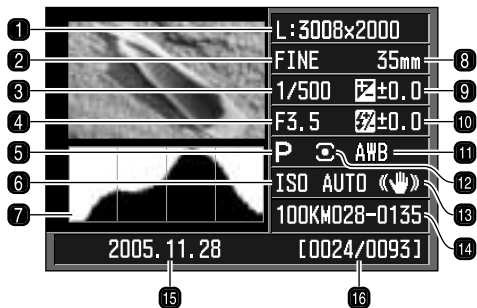

To view the histogram of the displayed image, press the up key. Press the down key to return to single-frame playback.

- | | |
|-------------------------------------|--|
| 1. Image size (p. 72) | 10. Flash compensation (p. 60) |
| 2. Image quality (p. 72) | 11. White-balance mode (p. 64) |
| 3. Shutter speed | 12. Metering mode (p. 59) |
| 4. Aperture | 13. Anti-Shake |
| 5. Exposure mode (p. 39) | 14. Folder name - file number (p. 120) |
| 6. Camera sensitivity (ISO) (p. 54) | 15. Date of recording |
| 7. Histogram | 16. Frame number / |
| 8. Focal length | Total number of images |
| 9. Exposure compensation (p. 48) | |

The dark area of the histogram shows the luminance distribution of the recorded image from black (left) to white (right). Each one of the 256 vertical lines indicates the relative proportion of that light value in the image. The histogram can be used to evaluate exposure and contrast, but displays no color information.



Luminance limit display

Areas of the image approaching the shadow and highlight luminance limit are indicated in the image thumbnail. The portions of the image which levels are close to 0 and 255 flash.

DELETING SINGLE IMAGES

 The displayed image can be deleted. Once deleted, an image cannot be recovered.



To delete a displayed image, press the delete button; a confirmation screen opens.



Use the left/right keys to highlight “Yes.” “No” cancels the operation.

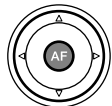

Press the controller to execute the command on the confirmation screen. The camera returns to playback mode.



Camera Notes

The camera can play back images on a television set. See page 101 on how to connect the camera to a TV with the supplied video cable.

CHANGING THE PLAYBACK DISPLAY

The display button controls the display format. Each time the button is pressed, the display cycles through to the next format: full display, image only, index playback. The index display can be changed in section 1 of the playback menu.



Full display



Image only



Index playback

In index playback, the four-way keys of the controller move the yellow border to the adjacent image. When the image is highlighted with the border, the date of recording, the lock and printing status, and the frame number of the image are displayed at the bottom of the screen. The highlighted image can be deleted using the delete button (p. 36).

When the display button is pressed again, the highlighted image is displayed in the single-frame playback mode. A four, nine, and sixteen image index can be displayed as well as a file browser. The index-playback format can be changed in section 1 of the playback menu (p. 82, 87).

ENLARGED PLAYBACK

An image can be enlarged for closer examination. The maximum magnification depends on image size from 2.4X for small images to 4.7X for large images.

Press the enlarge button to activate enlarged playback.

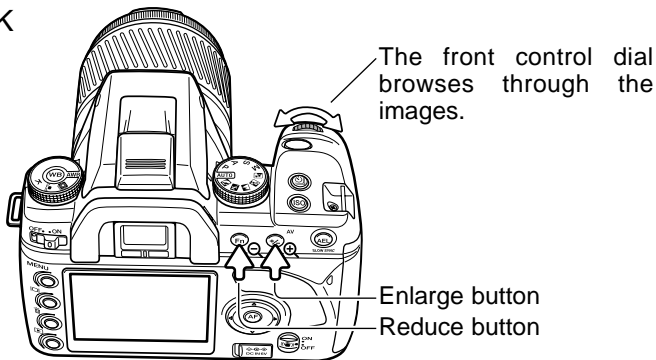

The controller's four-way keys scroll the magnified area.



The controller's four-way keys scrolls the magnified area. The locator (1) indicates the portion of the image displayed. The enlarge and reduce buttons change the magnification.

1
2



Press the central button of the controller to switch between displaying the entire image area and the magnified image.

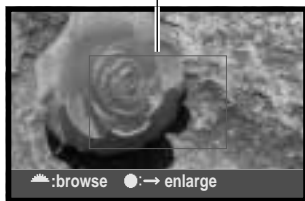

The magnification area (2) shows the portion of the image enlarged. The controller's four-way keys moves the magnification area. The enlarge and reduce buttons change the size of the area. Press the playback button to cancel enlarged playback.

ADVANCED RECORDING

This section contains detailed information on the camera's recording functions and operation. Read the sections pertaining to your interest and need.

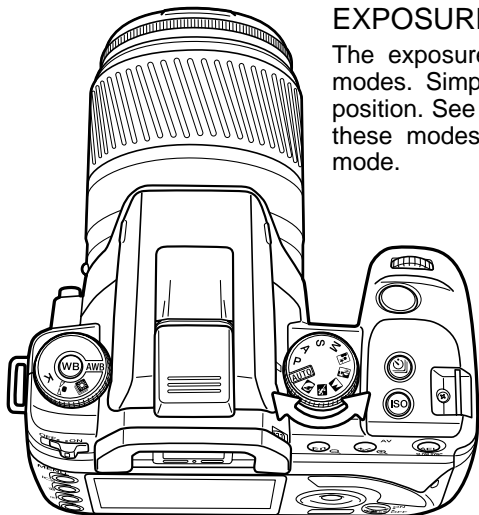

EXPOSURE-MODE DIAL

The exposure-mode dial is used to select the exposure modes. Simply turn the exposure dial to the appropriate position. See the following sections for more information on these modes. The monitor displays the active exposure mode.





Exposure mode



Exposure control

- AUTO** Auto recording (p. 41)
- P** Program exposure (p. 41)
- A** Aperture priority (p. 42)
- S** Shutter priority (p. 42)
- M** Manual exposure (p. 44)

Digital Subject Programs (p. 40)

-  Portrait
-  Sports Action
-  Landscape
-  Sunset
-  Night portrait

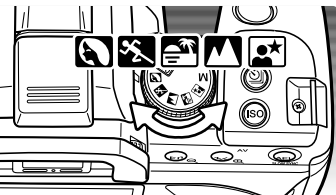

DIGITAL SUBJECT PROGRAMS

Digital subject programs optimize the camera's exposure, white-balance, and image-processing systems for specific conditions and subjects. Simply turn the exposure mode dial to select the appropriate subject program.



Portrait - optimized to reproduce warm, soft skin tones and a slight defocusing of the background. Most portraits look best with telephoto lenses; the longer focal length does not exaggerate facial features and the shallower depth of field softens the background. Use the built-in flash with strong direct sunlight or backlight to reduce harsh shadows.



Sports action - used to capture fast action by maximizing shutter speeds. When using a flash, make sure the subject is within the flash range (p. 55). Continuous autofocus (p. 58) and continuous-advance drive mode (p. 50) are active. A monopod is more flexible and compact than a tripod when shooting events.



Landscape - optimized to produce sharp, colorful landscapes. Used with bright outdoor scenery.



Sunset - optimized to reproduce rich, warm sunsets. Take care not to look directly at the sun when it is above the horizon; your eyesight could be damaged permanently.



Night portrait - for deep, subtle night scenes. When used with flash, the subject and background exposures are balanced. Use a tripod to eliminate blurring from camera shake. The flash can only be used with close subjects such as with a portrait of a person. When using the flash, ask your subjects not to move after the burst; long shutter speeds can be used for the background exposure.



Not all recording functions, such as the color mode and Digital Effects Control can be changed when using Digital Subject Programs. The use of auto white balance (AWB) is recommended when using Digital Subject Programs (p. 64).

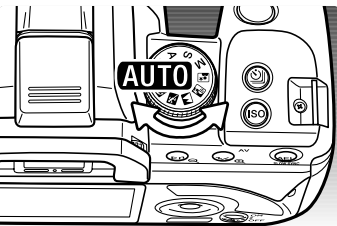

AUTO RECORDING

Auto recording is set with the exposure-mode dial. Use this exposure mode when wanting fully-automatic exposure control. Auto recording operates like the program exposure mode, except that when the exposure mode dial is turned to the auto-recording position, recording functions are reset to their default settings. Not all functions are available in auto recording such as color mode and Digital Effects Control.

Functions are reset to: fill-flash or red-eye reduction flash mode, multi-segment metering, Auto AF focus mode, wide AF area, single-frame advance drive mode, flash and exposure compensation reset, ADI flash control, Auto ISO, large-size images, fine image quality, AF priority, noise reduction.

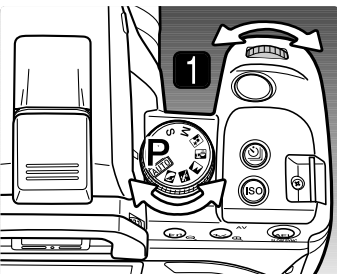

PROGRAM - P

Program exposure is set with the exposure-mode dial (p. 39). Like auto recording, program controls both the shutter speed and aperture required for each exposure. The operation is the same as described in the basic recording operation section on page 28. However, unlike auto recording, functions set in this mode do not reset when the position of the exposure-mode dial is changed. The default camera sensitivity for program is ISO 100.



Program shift

Program shift allows adjustment to the shutter-speed/aperture combination in 1/3 Ev increments without affecting the total exposure. Using the built-in flash cancels program shift.

Press the shutter-release button partway down until the shutter speed and aperture are displayed. Turn the control dial (1) to shift the shutter speed and aperture combination; P_s is displayed for the exposure mode. Program shift can be changed between aperture and shutter priority in section 1 of the custom menu (p. 92, 95).

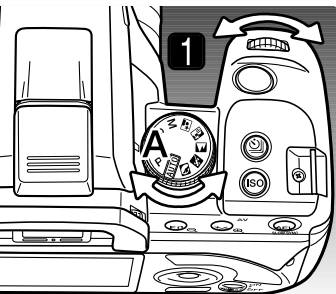

APERTURE PRIORITY - A

Aperture priority is set with the exposure-mode dial (p. 39). The photographer selects the aperture and the camera sets the appropriate shutter speed to ensure correct exposure.

Turn the control dial (1) to adjust the aperture in 1/3 Ev increments. The aperture range depends on the lens. The aperture is displayed on the monitor and in the viewfinder.

Pressing the shutter-release button partway down displays the corresponding shutter speed. With the camera sensitivity (ISO) set to auto, the shutter speed may not change when the aperture is adjusted because the shutter speeds can change in fine steps. Press the shutter-release button all the way down to take the picture. For information on *f*-numbers, see page 55.

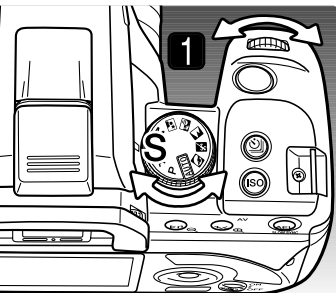

SHUTTER PRIORITY - S

Shutter priority is set with the exposure-mode dial (p. 39). The photographer selects the shutter speed and the camera sets the appropriate aperture to ensure correct exposure.

Turn the control dial (1) to adjust the shutter speed between 30 and 1/4000 second in 1/3 Ev increments. The shutter speed is displayed on the monitor and in the viewfinder.

Pressing the shutter-release button partway down displays the corresponding aperture. Press the shutter-release button all the way down to take the picture.

Flash Sync. Speed

There is a limit to the maximum shutter speed when using the built-in flash. When Anti-Shake is on, the maximum shutter speed that can be used is 1/125s. With Anti-Shake off, the flash sync. speed is 1/160s. While a faster shutter speed cannot be used, there is no limit to the use of slower shutter speeds. Flash range is dependent on the aperture, see page 55.

EXPOSURE CONTROL RANGE WARNINGS

Auto recording, Program, Digital Subject Programs



If the required exposure is beyond the shutter speed and aperture range, the shutter speed and aperture displays blink. In bright conditions, use a neutral density filter on the lens, set a lower camera sensitivity (ISO), or, if using artificial lights, reduce the intensity of the illumination. In dark conditions, use the built-in flash or increase the camera sensitivity (ISO).

Aperture priority



If the required exposure is beyond the shutter speed range, the shutter-speed display blinks. Adjust the aperture until the display is steady.

Shutter priority



If the required exposure is beyond the aperture range, the aperture display blinks. Adjust the shutter speed until the display is steady.

About Shutter Speeds

The shutter speed used for each exposure is displayed on the monitor and in the viewfinder. The following notation is used:

125 The reciprocal is used for shutter speeds from 1/4000 second to 1/3 second. 125 is 1/125 second.

1'5 15'' For shutter speeds of a half a second or longer, a quote mark is used to denote whole seconds. 1'5 is one and a half seconds and 15'' is fifteen seconds.

MANUAL EXPOSURE - M

Manual exposure mode allows individual selection of shutter speeds and apertures. This mode overrides the exposure system giving the photographer control over the final exposure. Bulb exposures can be made, see below. Manual exposure is set with the exposure-mode dial (p. 39).

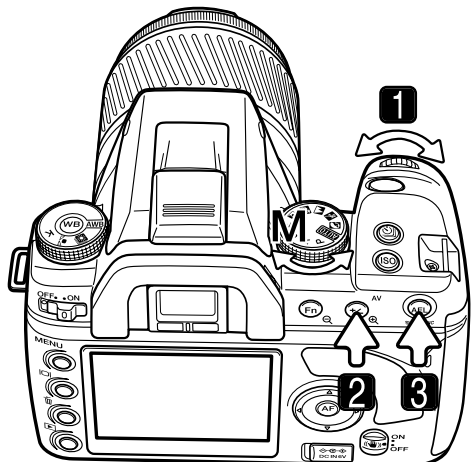

1. Turn the control dial to change the shutter speed.
2. Press and hold the exposure-compensation button and turn the control dial to change the aperture.

The operation to change the aperture and shutter speed can be reversed in section 1 of the custom menu (p. 95).

3. Press and hold the AEL button and turn the control dial to shift the shutter speed and aperture without affecting the exposure.

The Ev scale on the monitor and in the viewfinder indicates the difference between the set exposure and the exposure determined by the camera meter. Press the shutter-release button partway down to activate the meter. The manual metering (M.M.) indicator is displayed on the monitor Ev scale.



The set exposure is 1.0Ev less (-) than the exposure determined by the meter.



The arrow indicates the set exposure is 2.3Ev more (+) or less (-) than the exposure determined by the meter.



The blinking arrow indicates the set exposure is ± 2.7 Ev or greater than the exposure determined by the meter.

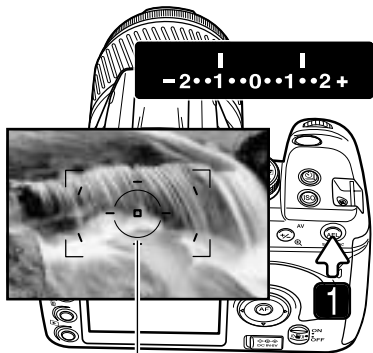

Spot metering area

By pressing and holding the AEL button (1), continuous meter readings are displayed on the Ev scales. Two indices can be displayed. The fixed index shows the meter reading made when the AEL button is pressed. The other index shows any changes in the metered area.

The fixed index is in reference to the selected metering mode (p. 59). The other index uses the spot metering area to determine the reading.

When using flash with manual exposure, the shutter speed cannot exceed the flash-sync speed (p. 42). Flash range is dependent on the aperture (p. 55).

BULB EXPOSURES

Bulb photographs can be taken in the manual-exposure mode (M). The use of a tripod, remote cord, and eyepiece cap (p. 111) is recommended. The camera's exposure system cannot be used to calculate bulb exposures. The use of a separate light meter is recommended. Anti-Shake is disabled.



1. Set the appropriate aperture required for the exposure.
2. Decrease the shutter-speed until "BULB" is displayed.
3. To take the picture, press and hold the shutter-release button for the duration of the exposure. Releasing the shutter button ends the exposure.

The monitor is blank during the exposure and remains blank after the exposure for up to 30 seconds while noise-reduction processing is applied to the image.

EXPOSURE LOCK - AEL BUTTON

The AE lock button locks the automatic exposure system without activating the AF system. This function allows the exposure to be set by a gray card or reference target outside the scene. When using flash in the auto recording, P, A, or digital subject program exposure modes, slow-shutter sync is active (p. 47). The operation of the AE lock button can be changed in section 1 of the custom menu (p. 94).



Frame the exposure target in the viewfinder depending on the metering mode in use (p. 59). Press and hold the AE lock button (1) to lock the exposure; the shutter speed and aperture are displayed and the AEL indicator is displayed in the viewfinder and on the monitor. Release the button to cancel the lock.

Spot metering area

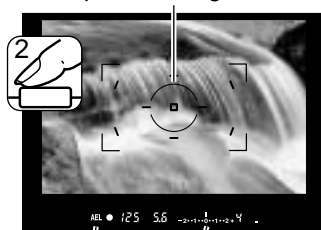

While holding the AEL button, place the subject in the focus frame and press the shutter-release button partway down to focus (2). Press the shutter-release button down all the way to take the picture.

The exposure remains locked after the picture is taken if the AEL button is not released.

AEL indicator
Ev scale



While the exposure is locked, the camera meter is still active. The viewfinder and monitor Ev scale shows the difference between the locked exposure and the current light level measured with the meter. Spot metering is used.

When the monitor and viewfinder Ev scale indicates 0, the locked exposure shown in the shutter-speed and aperture displays is the same as the exposure determined by the spot-metering area.



The metered area is 1.0Ev less (-) than the locked exposure.



The arrow indicates the metered exposure is 2.3Ev more (+) or less (-) than the locked exposure.



The blinking arrow indicates the metered exposure is ± 2.7 Ev or greater than the locked exposure.

SLOW SYNC.

When using flash, pressing the AEL button activates the slow-sync. function; slow sync. is not available in S and M exposure modes. Slow sync. balances the ambient light exposure with the flash exposure so the background is recorded with the subject.

When the AEL button is pressed and held, the ambient light exposure is determined and the flash exposure is based on the locked aperture setting. The use of a tripod is recommended with slow-sync. exposures.



SPOT-AF BUTTON

Spot AF can be used at any time. With the spot AF area placed on the subject, press and hold the central button of the controller to focus (1). The viewfinder focus signal confirms focus and the spot AF indicator (2) is displayed on the monitor. Pressing and holding the four-way controller key activates and locks focus with the wide focus area.

Compose the image in the viewfinder and press the shutter-release button all the way down to take the picture. Focus remains locked after the picture is taken until the central controller button is released.

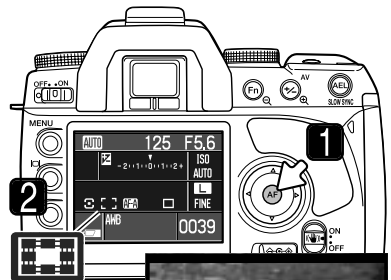

Spot AF area

Focus signal



EXPOSURE COMPENSATION

When using auto recording, P, A, and S exposure modes or a digital subject program, the exposure can be compensated.

To compensate the ambient exposure, press and hold the exposure-compensation button and turn the control dial; the degree of compensation is displayed on the monitor and viewfinder Ev scales.

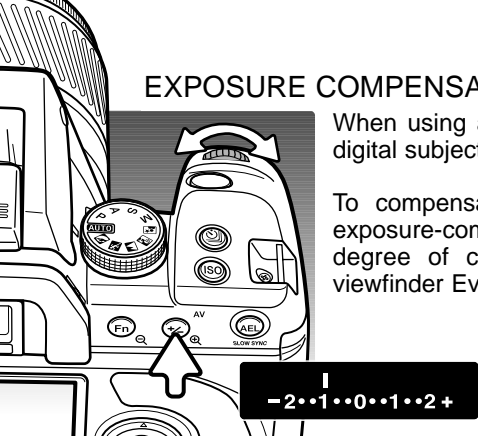

The exposure is compensated by -1.0Ev.

After the setting is made, the shutter-speed and aperture displays indicate the actual exposure. Because exposure compensation uses 0.3Ev increments, lens apertures may not be displayed correctly.

Sometimes the camera's exposure meter is deceived by high key or low key subjects. In the example below, the dark water caused the camera to overexpose the image making it bright and washed-out. By compensating the exposure, detail is brought out in the leaves, and the stones and water appear richer.



Metered camera exposure



-1.0Ev



-2.0Ev

DEPTH-OF-FIELD PREVIEW

The aperture controls depth of field; the area in front of the camera that appears in focus. The smaller the aperture, the greater the depth of field. Depth-of-field preview sets the lens aperture to the setting used in the exposure so the affect of depth of field can be seen in the viewfinder.

Press the shutter-release button partway down to lock the focus and exposure. Press the depth-of-field preview button to stop down the aperture.

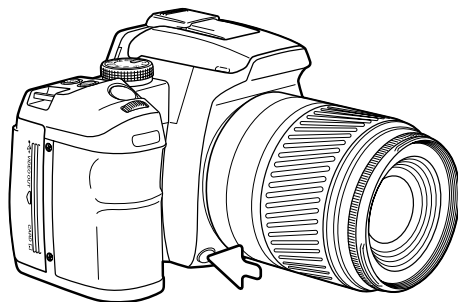

Camera Notes

Some Konica Minolta lenses are equipped with focus-hold buttons. Section 1 in the custom menu allows the focus-hold button to be used for depth-of-field preview (p. 94).

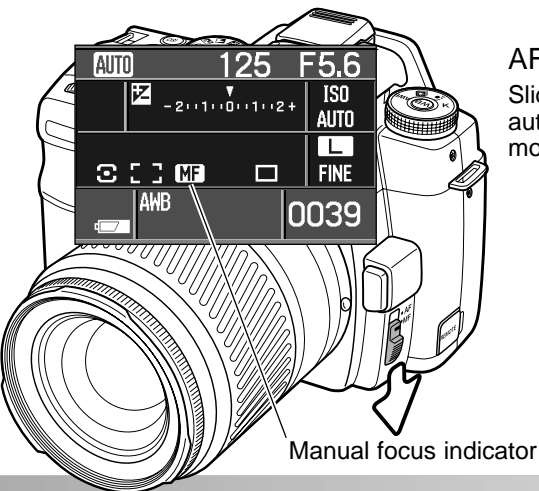

AF / MF SWITCH

Slide the AM/MF switch to change between autofocus and manual focus. An indicator on the monitor shows the active focus mode.

DRIVE MODES

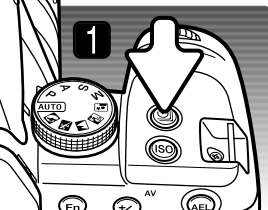

Drive-mode indicator

The drive modes control the rate and method of image capture. Single-frame advance is the default drive mode and is described in the basic recording section on page 28. The drive mode is set with the drive-mode selection screen. Press the drive-mode button (1) to open the screen.

Single-frame and Continuous advance - to take single or multiple images at one time (p. 51).

Self-timer - to delay the release of the shutter by 10 or 2 seconds (p. 51).

Exposure bracketing - to take a series of 3 images with differing exposure (p. 52).

White-balance bracketing - to make 3 images with differing white balance (p. 53) from a single exposure.

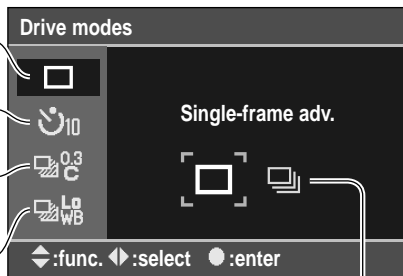

Options



Use the up/down keys of the controller to select the drive-mode group.



Use the left/right keys of the controller to highlight the drive-mode option.



Press the center button of the controller to select the drive mode. An indicator is displayed on the monitor to confirm the selection.

CONTINUOUS-ADVANCE NOTES

Continuous-advance mode allows a series of images to be captured while holding down the shutter-release button. The maximum frame rate is 3fps until the camera buffer memory is full. The frame rate after that depends on the writing speed of the memory card. Five RAW or three RAW + JPEG will fill the camera buffer memory. The number of JPEG images depend on the subject; some subjects can be compressed further than others.

AF Zoom xi and Power Zoom lenses cannot be zoomed when taking pictures with continuous advance. The frame rate is affected by the flash as it must recharge between exposures. Focus and exposure are set between each frame with continuous AF and Auto AF.

SELF-TIMER NOTES

With the camera on a tripod, compose the picture as described in the basic recording section (p. 28). Press the shutter-release button partway down to lock the exposure and focus. Press the shutter-release button all the way down to begin the countdown.

Because focus and exposure are determined when the shutter-release button is pressed, do not stand in front of the camera when taking a self-timer image. Always confirm the focus with the focus signals before beginning the countdown. Attach the eyepiece cap if a bright light source is behind the camera, see page 111.

With the ten-second self-timer, the self-timer lamp on the front of the camera and the audio signals indicate the countdown. The lamp glows steadily just before the shutter fires. To stop the countdown, change the position of the exposure-mode dial or flash (lift it or push it down), or turn the camera off. The audio signal can be turned off in section 1 of the setup menu (p. 98). The mirror raises just before the exposure.

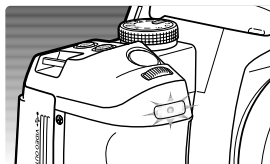

With the two-second self-timer, no indication is given during the countdown. The mirror raises when the countdown starts.

EXPOSURE BRACKETING NOTES

Bracketing is a method of taking a series of images of a static subject in which each image has a slight variation in exposure. Exposure and flash brackets can be made.

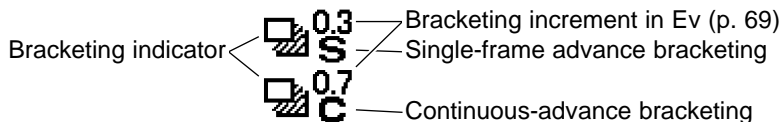

Select continuous-advance bracketing or single-frame advance bracketing and the bracketing increment with the drive-mode selection screen (p. 50). Continuous-advance bracketing creates a successive series of three images automatically when the shutter-release button is pressed and held. The shutter-release button must be pressed for each exposure when using single-frame advance bracketing. The greater the increment, the greater the difference among the images. When selected, the number of frames and the bracketing increment is displayed on the Ev scale. The bracketing order can be set in section 2 of the recording menu (p. 80).



Exposure bracket: 0.3 Ev



Flash bracket: 0.7 Ev

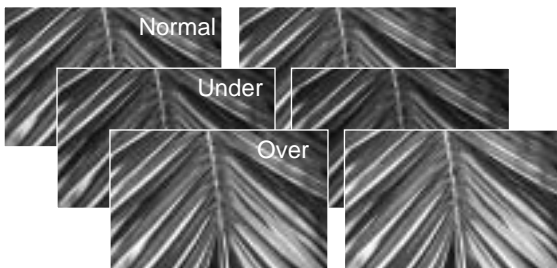

0.3 Ev bracket

0.7 Ev bracket

To make a flash bracket, raise the camera flash; the ambient exposure is not bracketed. Only single-frame advance flash brackets can be made regardless of the specified mode; press the shutter-release button for each exposure. The built-in flash recharges between exposures. Exposure brackets are made when the flash is down.

Compose the picture as described in the basic recording section (p. 28). As the bracket is made, the index marks disappear from the Ev scale to show the remaining frames. When making a continuous-advance bracket, if the shutter button is release before the bracket is completed, the bracket resets. If using continuous AF or Auto AF with moving subjects (p. 58), the camera focuses between each exposure.

When exposure brackets are made in S exposure mode, the aperture controls the bracket. In A and M exposure modes, the shutter speed controls the bracket; in M mode, pressing the AEL button during the bracket changes the exposure control to the aperture. The camera uses both the aperture and shutter speed control the bracket in P and auto recording.

WHITE-BALANCING BRACKETING NOTES

White-balance bracketing creates three images from a single exposure in which each image has a slight variation in color temperature. For more on white balance, see page 64.



Low white-balance bracket



High white-balance bracket

Select the appropriate white-balance bracketing drive mode with the drive-mode selection screen (p. 50). The low white-balance bracket uses an approximate 10 mired shift from the normal balance. The high white-balance bracket uses an approximate 20 mired shift from the normal balance.

Compose and take the picture as described in the basic recording section (p. 28). When the exposure is made, the camera automatically creates two other images with the appropriate shift in white balance.

CAMERA SENSITIVITY (ISO) AND ZONE MATCHING

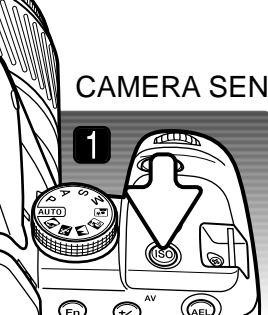

Camera sensitivity display

Camera sensitivity can be changed. Zone Matching for high-key or low-key subjects can be activated. The sensitivity setting is displayed on the monitor. Press the camera-sensitivity button (1) to open the setting screen.

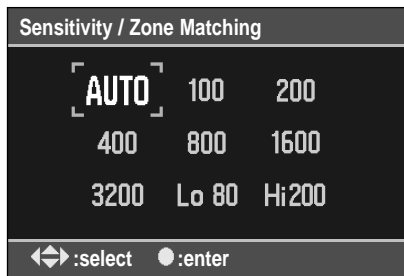

Use the four-way keys of the controller to highlight the sensitivity option. The Hi 200 and Lo 80 options are for Zone Matching, see below.

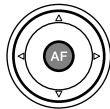

Press the center button of the controller to complete the operation.

The auto setting automatically adjusts the camera sensitivity to the light conditions between ISO 100 and 800, and ISO 100 and 400 when using flash. The fixed numerical settings are based on the film ISO equivalent: the higher the number, the more sensitive. As the ISO value doubles, the camera sensitivity doubles; a change of one Ev. Noise increases with sensitivity; an ISO setting of 100 has the least noise and 3200 has the most. Noise is a grainy texture that can be apparent in the image.

Zone Matching is used for recording high-key (Hi200) or low-key (Low80) scenes. The number refers to the approximate ISO equivalent for reflected-light meter measurements. A high-key scene is made up of predominately light tones and colors. A low-key scene is made up of dark tones and colors. Zone Matching controls exposure and contrast to improve reproduction of these scenes. When selected, the zone indicator is displayed in the camera-sensitivity display on the monitor. Any changes to contrast with the Digital Effects Control are canceled (p. 63).

CAMERA SENSITIVITY AND FLASH RANGE

A change in camera sensitivity (ISO) affects the flash range. The flash range depends on the aperture used:

ISO setting	<i>f</i> /2.8	<i>f</i> /4.0	<i>f</i> /5.6
Low80	1.0 ~ 3.8m / 3.3 ~ 12ft.	1.0 ~ 2.7m / 3.3 ~ 8.9ft.	1.0 ~ 1.9m / 3.3 ~ 6.2ft.
100	1.0 ~ 4.3m / 3.3 ~ 14ft.	1.0 ~ 3.0m / 3.3 ~ 9.8ft.	1.0 ~ 2.1m / 3.3 ~ 6.7ft.
200 / Hi200	1.0 ~ 6.0m / 3.3 ~ 20ft.	1.0 ~ 4.3m / 3.3 ~ 14ft.	1.0 ~ 3.0m / 3.3 ~ 9.8ft.
400 / AUTO	1.4 ~ 8.6m / 4.6 ~ 28ft.	1.0 ~ 6.0m / 3.3 ~ 20ft.	1.0 ~ 4.3m / 3.3 ~ 14ft.
800	2.0 ~ 12m / 6.6 ~ 39ft.	1.4 ~ 8.6m / 4.6 ~ 28ft.	1.0 ~ 6.0m / 3.3 ~ 20ft.
1600	2.8 ~ 17m / 9.2 ~ 56ft.	2.0 ~ 12m / 6.6 ~ 39ft.	1.4 ~ 8.6m / 4.6 ~ 28ft.
3200	4.0 ~ 24m / 13 ~ 79ft.	2.8 ~ 17m / 9.2 ~ 56ft.	2.0 ~ 12m / 6.6 ~ 39ft.

What is an *f*-number?

An *f*-number indicates the relative aperture of the lens and lets us determine how much light it lets through. But why does the number get bigger when the amount of light decreases? The answer is in the way it is written, *f*/2.0, *f*/8.0. etc. That means the focal length of the lens (*f*) divide by 2 or 8. So a 100mm lens at *f*/2 has a 50mm physical aperture (100/2) and at *f*/8, a 12.5mm physical aperture (100/8). So the *f*-number indicates the size of the aperture as a fraction of the focal length of the lens.

The *f*-number series was carefully chosen to make controlling exposures easy. In the chart, the aperture and shutter speed combinations give the exact same exposure. Notice how the shutter speed changes to compensate for the change in aperture.

<i>f</i> /2.8	1/2000s
<i>f</i> /4.0	1/1000s
<i>f</i> /5.6	1/500s
<i>f</i> /8.0	1/250s
<i>f</i> /11	1/125s
<i>f</i> /16	1/60s
<i>f</i> /22	1/30s
<i>f</i> /32	1/15s

FUNCTION BUTTON

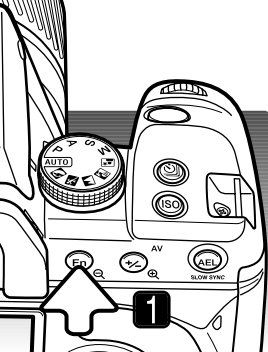

Function indicators

AF area, focus mode, metering mode, flash compensation, color mode, and Digital Effects Control are set with the function button. Monitor indicators show active settings. Press the button (1) to open the setting screen.

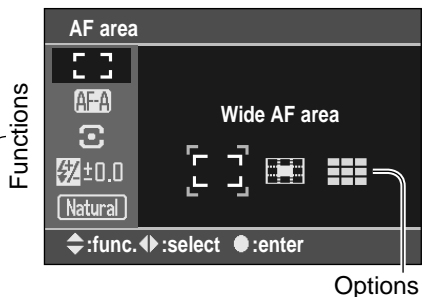

Use the up/down keys of the controller to select the function.



Use the left/right keys of the controller to highlight the option or adjust the setting.



Press the center button of the controller to complete the operation.

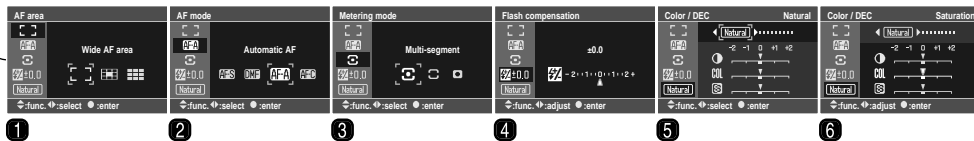

See the following sections for more on each function. The color mode and Digital Effects Control cannot be set when using auto recording or a digital subject program. Flash compensation is only displayed when the flash is raised.

1. AF area (p. 57)
2. AF mode (p. 58)
3. Metering mode (p. 59)
4. Flash compensation (p. 60)
5. Color mode (p. 61)
6. Digital Effects Control (p. 63)



AF AREA

AF-area modes control which AF areas are used for focus. The modes are selected with the function button (p. 56). The active AF area is indicated on the monitor.



Wide AF area - to use the wide focus frames in the viewfinder to focus. See the basic operation section on page 28. Pressing and holding the four-way controller keys also activates and locks focus with the wide focus area. Spot AF can be used, see page 47.



Spot AF area - the spot AF area is used for focus. The shutter release button and all controller keys active spot AF.



Focus area selection - a specific AF area can be selected. Only the spot AF area can be used with the AF Reflex 500mm f/8 and AF Power Zoom 35-80mm f/4.0-5.6 lenses.



Spot AF area



When focus-focus area selection is active, use the controller to select the AF area; autofocus activates and locks each time an area is selected. The central button selects the spot AF area. Focus remains locked after the picture is taken until the controller is released.

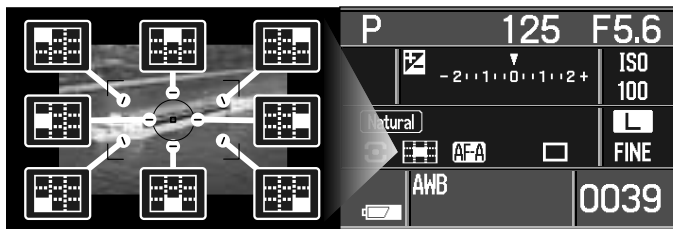

The active area is indicated on the monitor and is briefly illuminated in the viewfinder.

AF MODES

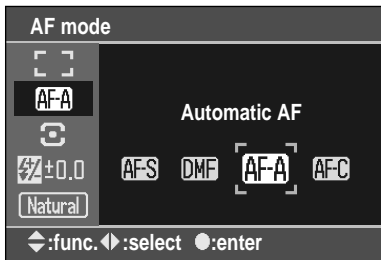

Single-shot AF (Autofocus), continuous AF, automatic AF, and direct manual focus is set with the function button (p. 56).

The AF system activates when the shutter-release button is pressed partway down or with the controller (p. 57). Focus is confirmed with the viewfinder focus signals, see page 29.



Single-shot AF - a general purpose autofocusing mode. Its operation is described in the basic recording section. Focus lock is available (p. 30).



Automatic AF - this AF mode automatically switches between single-shot AF and continuous AF depending on the subject's motion.



Continuous AF - used for photographing moving subjects. The camera continuously focuses on the subject even when the shutter-release button is pressed partway down. Spot and local AF areas illuminate as the subject moves through the wide focus frames to indicate the point of focus when the continuous AF is active. Focus lock is not available.



Direct manual focus - operates like automatic AF, but after the AF system focuses, the focus can be adjusted manually by the photographer. Press the shutter-release button partway down or press the controller to activate the AF system. When the viewfinder focus signal is displayed, manually focus the lens. Do not attempt to focus the lens until the focus signal is displayed.

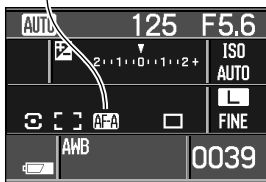

The active mode is displayed on the monitor.

METERING MODES

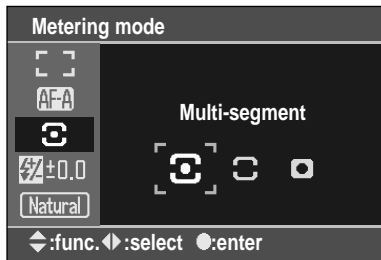

The metering mode specifies the metering pattern. The metering mode is set with the function button (p. 56).

On the function-selection screen, use the up/down keys of the controller to select the metering modes and the left/right keys to select the specific mode. Press the central button of the controller to complete the operation.



Multi-segment metering - the camera's standard metering mode appropriate for most photographic situations. By combining information on the subject's distance and position from the autofocus system, this mode is less influenced by spot lighting or backlighting.



Center weighted - measures light values over the entire image area with emphasis given the central region.



Spot - uses a circular area within the image to calculate the exposure. Spot metering allows precise exposure measurements of a particular object without being influenced by extremely bright or dark areas within the scene.

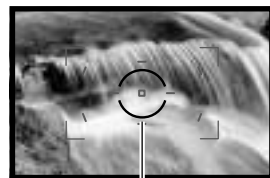

Spot metering area



The active mode is displayed on the monitor.

If the luminance levels of the scene are outside the metering range, both arrows at each end of the Ev scale blink. In dark conditions, use the camera flash. Under bright light, use a neutral density filter on the lens to control the light levels.

FLASH COMPENSATION

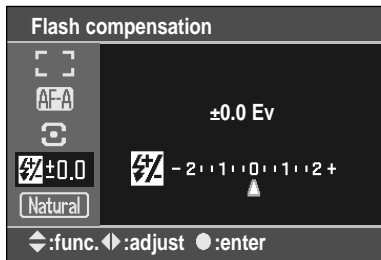

The relative output of the flash can be compensated by ± 2.0 Ev with the function button (p. 56).

On the function-selection screen, use the up/down keys of the controller to select exposure compensation and the left/right keys to adjust the degree of compensation. Press the central button of the controller to complete the operation.

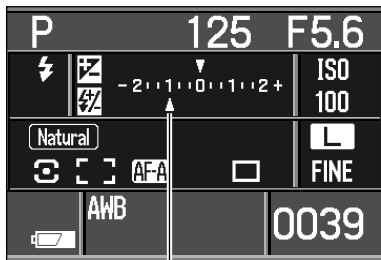

When the camera flash is raised, the degree of flash compensation is indicated by the Ev scale.

When using fill-flash to reduce harsh shadows caused by bright illumination or direct sunlight, flash compensation can change the ratio between the highlights and shadows. Fill flash affect the darkness of the shadows without affecting the area illuminated by the main light source.

-1.0 Ev flash compensation



Positive compensation

No compensation

Negative compensation

No flash

By decreasing the flash output with a negative Ev setting, the shadows receive less light and are darker, but subtle details in the shadows that would not appear without the flash are apparent. Increasing the flash output by using a positive Ev setting softens and nearly eliminate shadows.

COLOR MODE

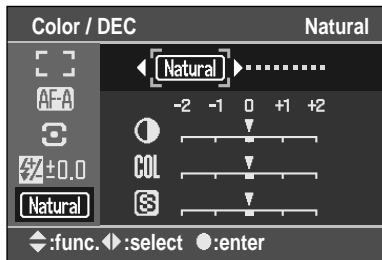

The color mode controls what the image looks like as well as the color space. The color mode is set with the function button (p. 56). The color mode can only be selected in P, A, S, and M exposure modes. Except for the Adobe RGB and embed Adobe RGB, all color modes use sRGB color space. Some color modes use preset Digital Effects Control values (p. 63); the default positions are indicated by a thick index mark on the scale of the setting screen.



Natural Color - reproduces the colors in the scene faithfully.



Natural Plus - increases contrast and acutance.



Portrait - optimize for the reproduction of skin tones.



Landscape - optimize for daytime outdoor scenery.



Sunset - optimize for landscapes at dusk and dawn. The use of auto white balance is recommended.



Night view - optimize for nighttime scenery without flash.



Night portrait - optimize for nighttime portraits with flash.



Black & White - for monochrome images.



Adobe RGB - natural color reproduction using the extended gamut Adobe RGB color space. The color space is not embedded in the image data.



Embedded Adobe RGB - natural color reproduction using the extended gamut Adobe RGB color space. The color space is embedded in the image data.

(Continued on the next page.)

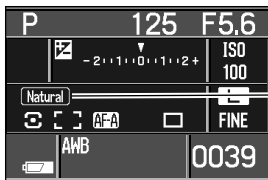

The active mode is displayed on the monitor. When using portrait, landscape, sunset, night view, or night portrait color mode, the use of auto white balance is recommended.

About Adobe RGB

Adobe RGB has a larger color gamut than the more common sRGB. The size of the gamut limits the colors that can be reproduced; the larger the gamut, the more colors. If the image will be printed out with a high-quality printer, the use of the Embedded Adobe RGB and Adobe RGB color modes are recommended over the other sRGB color modes.

Embedded Adobe RGB image files are indicated with a .JPE extension. Adobe RGB images without an embedded profile use a file name beginning with _ICT. See page 120 for more information.

Always use DFC 2.0 optional color space compliant software to open Adobe RGB images without embedded profiles. DiIMAGE Master Lite 1.0.1 or DiIMAGE Master 1.1 or later is DFC 2.0 optional color space compliant. Always use software with color matching or color management functions to open Adobe RGB images with embedded profiles. Software without color management functions, such as Kodak EasyShare, will not reproduce Adobe RGB images correctly.

DiIMAGE Master Lite supplied with the camera is required to open RAW Adobe RGB images taken with this camera. The full version of DiIMAGE Master can also be used. For more on DiIMAGE Master, see page 81 or visit us on the web at:

North America

<http://kmpi.konicaminolta.us/>

Europe

<http://www.konicaminoltasupport.com>

DIGITAL EFFECTS CONTROL (DEC)

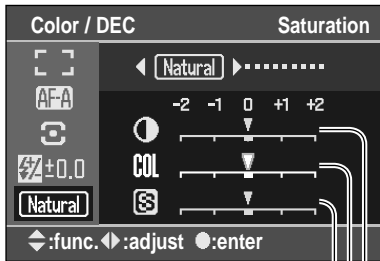

Sharpness
Color saturation
Contrast

The Digital Effects Control can make adjustments to the contrast, color saturation, and sharpness of specific color modes. Some color modes use preset Digital Effects Control values, the default positions are indicated by a thick index mark on the scale. Digital effects are set with the function button (p. 56).

On the function-selection screen, use the up/down keys of the controller to select the contrast, saturation, or sharpness control; the selected control is highlighted. Use the left/right keys to make adjustments. Press the central button of the controller to complete the operation.



When set to any value other than zero, an indicator and value is displayed on the monitor as a warning. The Digital Effects Control can only be used in P, A, S, and M exposure modes.



Changes in sharpness may not be apparent on the camera monitor.





WHITE BALANCE

White balance is the camera's ability to make different types of lighting appear natural. The active white-balance mode is displayed in the white-balance panel on the monitor.



Turn the white-balance dial to the appropriate position.

AWB Auto white balance - white balance is set automatically.



Preset white balance - to set the white balance to a specific light source.



Custom white balance - to calibrate the camera to a specific lighting situation.



Color temperature - to set the white balance to a specific color temperature.

The last changes made are displayed on the monitor. Press the white-balance button in the center of the dial to change settings. See the following sections for more information. If the exposure-mode dial is turned to the auto recording or a digital subject program position, white balances is reset to auto.

AWB - AUTO WHITE BALANCE



Auto white balance automatically detects the type of light and adjust the white balance accordingly. When the built-in flash is used, the white balance is set for the color temperature of the flash. Simply set the white-balance dial to the AWB position.

PRESET WHITE BALANCE

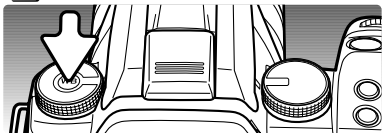

With the white balance dial in the preset white balance position, press the white-balance button to open the setting screen.

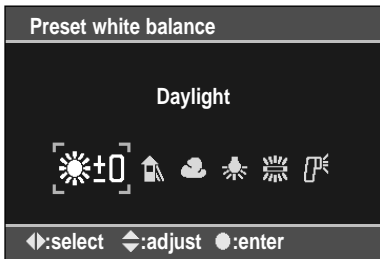

Use the left/right controller keys or control dial to select the white-balance setting.



The up/down controller keys shift the white-balance, see below.



Press the central controller button to complete the operation.

The up/down controller keys adjust the white balance in seven levels: +3 to -3 (+4 to -2 for fluorescent). Except for fluorescent, the change of one unit is approximately equal to a 10 mired shift.



Daylight - for outdoor sunlit subjects.



Shade - for subjects illuminated by skylight: shady conditions on a clear day.



Cloudy - for cloudy or overcast outdoor conditions.



Tungsten - for incandescent lighting: household filament light bulbs.



Fluorescent - for fluorescent lighting: office ceiling lights.



Flash - for electronic flash.

For more information on light sources, see page 69.

CUSTOM WHITE BALANCE

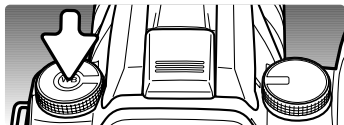

Custom-white-balance function allows the camera to be calibrated to a specific lighting condition. With the white balance dial in the custom position, press the white-balance button to open the setting screen.

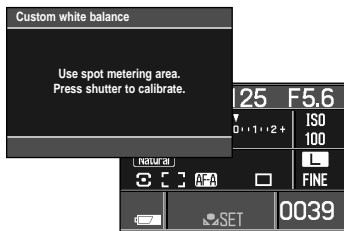

A guidance message appears. If the shutter-release button is pressed partway down, the monitor display returns. The red custom set indicator is displayed in the white-balance panel. Turn the white-balance dial to another position to cancel the routine.

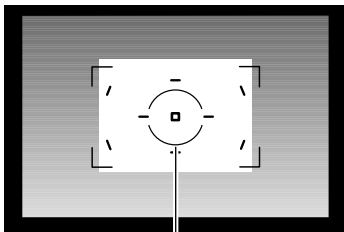

Spot metering area

Fill the spot metering area with a white or neutral object; the object does not need to be in focus. Press the shutter-release button all the way down to calibrate the camera.

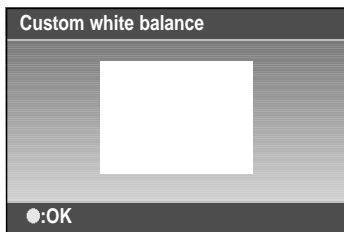

An image of the reference target is displayed. Press the central button of the controller to complete the operation.

A calibration error may occur under extremely bright light sources, especially with flash units. If an error occurs, a message appears on the monitor and the white-balance indicator is yellow. Repeat the procedure by recalibrating using a gray card as a reference target to reduce the intensity of the illumination.

K COLOR TEMPERATURE

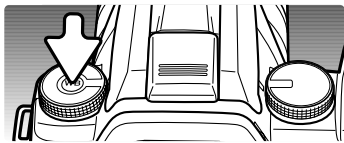

White balance can be set to a known color temperature of a light source or set to the color temperature determined by a color meter. With the white balance dial in the color temperature (K) position, press the white balance button to open the setting screen.

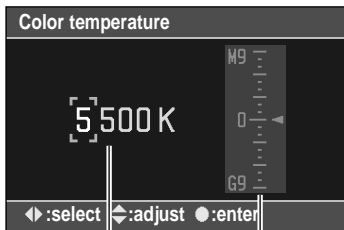

Color temperature
Magenta/Green compensation



Use the left/right controller keys or control dial to select among thousand° K, hundred° K, and magenta/green compensation.



Use the up/down controller keys to adjust the value.



Press the central controller button to complete the operation.

Color temperature refers to the color of the light emitted from a blackbody radiator at a specific temperature given in degrees Kelvin. This is an accurate way of measuring light from continuous-spectrum sources such as the sun and incandescent or tungsten light bulbs.

However, color temperature alone can be inaccurate with discontinuous-spectrum sources such as fluorescent. The magenta/green compensation scale allows adjustments to compensate for this problem. The increment on the scale is equivalent to approximately 5CC; M3 would be 15CC magenta.

For information on light sources, see page 69.

A SHORT GUIDE TO PHOTOGRAPHY

Photography can be a rewarding pursuit. It is a broad and disciplined field that can take years to master. But the pleasure in making photographs and the joy of capturing a magical moment cannot be compared. The guide is an introduction to some basic photographic principles.

The lens aperture controls not only exposure, but also depth of field; the area between the closest object in focus and the furthest object in focus. The larger the aperture value, the greater the depth of field and the longer the shutter speed needed to make the exposure. The smaller the aperture value, the shallower the depth of field and the faster the shutter speed needed to make the exposure. Usually landscape photographs use a large depth of field (large aperture value) to keep the foreground and background in focus, and portraits use a shallow depth of field (small aperture value) to separate the subject from the background.

Depth of field also changes with focal length. The smaller the focal length, the greater the depth of field; the longer the focal length, the shallower the depth of field.

The shutter controls not only exposure, but also the ability to stop motion. Fast shutter speeds are used in sport photography to stop action. Slow shutter speeds can be used to show the flow of motion such as water cascading over a waterfall. The use of a tripod is recommended with slow shutter speeds.

For critical work, take a test photograph and view the result in playback. The image can be deleted if not acceptable

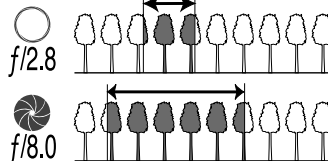

LIGHT SOURCES AND COLOR

The human eye adapts itself extremely well under different conditions. The paper of this manual you are reading looks white regardless of the type of lighting. Photographic systems are much less flexible. As the light source changes, so does the overall color of a scene - fluorescent office ceiling lights create a green cast to pictures, regular household tungsten light bulbs make everything red. Like your eyes, the camera's white-balance controls adjust for different lighting to make natural looking pictures.

The most common source of light, our sun, changes color depending on the time of day and the atmospheric conditions. The sun is of course very warm near the horizon and very blue at noon. The daylight preset white-balance setting is for beautiful sunny days. When the weather is overcast, the color is cooler and the cloudy setting is appropriate. When the main light source is skylight, light from the blue sky rather than the direct light of the sun, the resulting color is very blue. The shade preset white-balance is designed for this condition.

Artificial lighting is more consistent but shows variations. Tungsten lamps become warmer as their wattage decreases. And fluorescent lamps come in classifications that define their color. The preset white balance settings can be adjusted to match the change in these light sources.

Some artificial lighting have a discontinuous spectrum that create very unnatural color in a photograph. White balance cannot correct high-energy vapor lighting: sodium-vapor (yellow highway lights), or mercury vapor. For portraits under these lighting conditions, the flash can be used to overpower the ambient light. With landscapes containing these types of lights, set the white balance to the preset daylight setting.

WHAT IS AN EV?

Ev stands for exposure value. A change of one Ev adjusts the exposure calculated by the camera by a factor of two. An Ev and a "stop" are the same.

+2.0 Ev	4X as much light
+1.0 Ev	2X as much light
±0.0 Ev	Calculated exposure
-1.0 Ev	1/2 as much light
-2.0 Ev	1/4 as much light

RECORDING MENU

In recording mode, press the menu button to open and close the menu. The four-way keys of the controller move the cursor in the menu. Pressing the central button of the controller enters a setting.

NAVIGATING THE RECORDING MENU

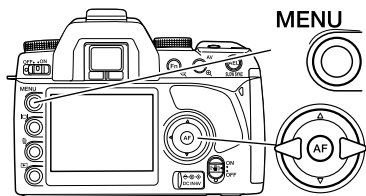

Activate the recording menu with the menu button. Tab 1 at the top of the menu is highlighted.

Use the left/right keys of the controller to highlight the appropriate menu tab; the menus change as the tabs are highlighted.



When the required menu section is displayed, use the up/down key to scroll through the menu options. Highlight the option whose setting needs to be changed.



Press the right controller key to display the settings; the current setting is indicated by an arrow. To return to the menu options, press the left key.



Use the up/down key to highlight the new setting. If "Enter" is displayed, press the central button of the controller to open the next screen.



Press the central button of the controller to select the highlighted setting.

Once a setting has been selected, the cursor returns to the menu options and the new setting is displayed. Changes can continue to be made. To return to the recording mode, press the menu button.

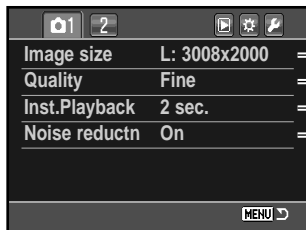

To set image resolution (p. 72).

To set file type and compression (p. 72).

To play back images after they are recorded (p. 74).

To apply noise reduction to long exposures (p. 74).

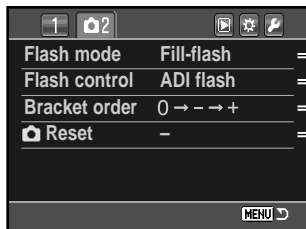

To set the flash mode of the built-in flash (p. 75).

To set ADI or pre-flash flash control (p. 79).

To set the order of the bracketing frames (p. 80).

To reset the recording-mode functions (p. 80).

Camera Notes

The control dial moves the cursor left and right in the menu.

The menu section memory option in section 3 of the setup menu memorizes the last menu section opened and returns to that section when the menu button is pressed (p. 106).

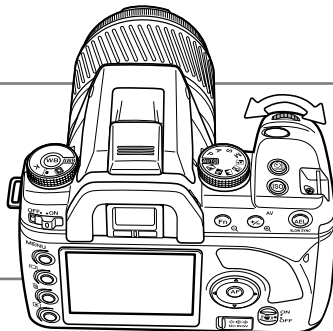

IMAGE SIZE AND IMAGE QUALITY

Image size and quality are set in section 1 of the recording menu (p. 70). Changes are displayed on the monitor.

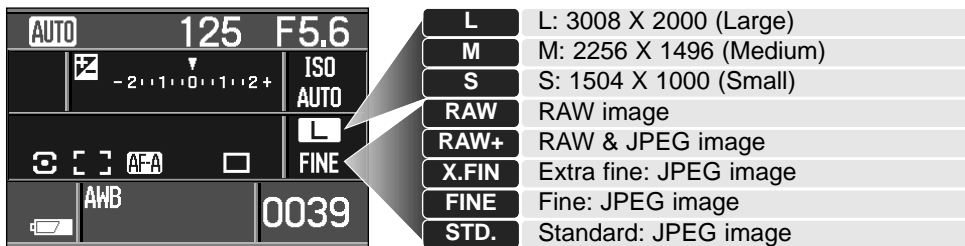

Image size affects the number of pixels in each image. The greater the image size, the larger the file size. Choose image size based on the final use of the image - smaller images are more suitable for web sites whereas larger sizes produce higher quality prints.

Image quality controls the file type and rate of compression. RAW is high-quality image file. The extra fine, fine, and standard settings produce JPEG files at various rates of compression. The higher the image quality, the lower the rate of compression and the larger the file sizes. If economical use of the memory card is important, use the standard mode. The RAW & JPEG option creates two image files at one time, a large RAW file and a fine quality JPEG file with an image size selected with the menu. The image files are saved with the same file name, but with different extensions (p. 120).

In the RAW image-quality mode, the image size is set to large and cannot be changed. The image size is not displayed on the monitors. The enlarged playback and print functions cannot be used.

Unlike the other image-quality modes, RAW image data is unprocessed and requires image processing before it can be used. To process the RAW data, DiIMAGE Master 1.1 or later, or DiIMAGE Master Lite 1.0.1 or later is required. A copy of DiIMAGE Master Lite 1.0.1 is supplied with the camera.

The number of images that can be stored on a memory card is determined by the size of the card and the file size of the images. One memory card can contain images of differing sizes and quality. The actual file size is determined by the scene; some subjects can be compressed further than others.

Approximate file sizes.			
	L: 3008 x 2000	M: 2256 X 1496	S: 1504 X 1000
RAW	8.8MB	–	–
Extra fine	5.9MB	3.3MB	1.6MB
Fine	3.0MB	1.7MB	850KB
Standard	1.8MB	1.0MB	540KB
Approximate number of images that can be stored on a 512MB memory card.			
RAW	53	–	–
Extra fine	82	145	314
Fine	163	282	584
Standard	277	470	926

Camera Notes

The frame counter indicates the approximate number of images that can be stored on the memory card at the camera's image quality and size settings. If the settings are changed, the frame counter adjusts accordingly. Because the counter uses approximate file sizes, the actual image taken may not change the counter or may decrease it by more than one. When the frame counter displays zero, it indicates no more images at the image size and quality settings can be captured. Changing those settings may allow more images to be saved to the card.



Frame counter

INSTANT PLAYBACK

After an image is captured, it can be displayed on the monitors for two, five, or ten seconds before being saved. The last image of a continuous-advance or continuous-advance bracketing series is displayed. Instant playback is activated and the length of the playback period is set with the instant-playback option in section 1 of the recording menu (p. 70).

During the instant playback period, many of the playback functions are available. The displayed images can be deleted using the delete button (p. 36). An images can be magnified with the enlarge button (p. 38). The information display can be turned off and on with the display button, and the histogram can be displayed using the up key of the controller (p. 35). When using continuous advance or continuous-advance bracketing, use the left/right controller keys or turn the control dial to display the frames in the series; playback mode is active and all images on the memory card can be viewed and the playback menu opened.

Press the shutter-release button partway down or press the playback button to return to the recording mode.

NOISE REDUCTION

This function reduces the affect of dark noise with exposures of one second or longer. Processing is applied to each image after it is captured. The monitor remains blank during processing for a maximum of 30 seconds. This can be turned off in section 1 of the recording menu (p. 70). Noise reduction uses dark-frame subtraction. Noise reduction is not applied to a continuous-advance series.

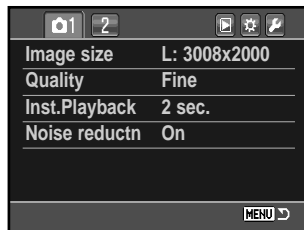

Display button

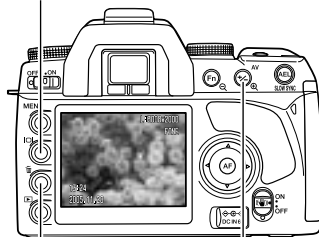

Delete button

Enlarge button

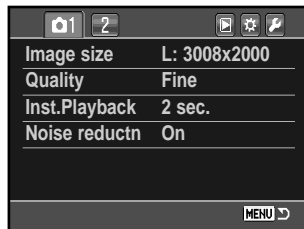



FLASH MODES

The flash mode can be changed in section 2 of the recording menu (p. 70). For the flash to fire, the built-in unit must be manually raised; lower the flash to prevent it from firing. The auto-white-balance setting gives priority to the flash's color temperature. If another type of white balance is used, priority is given to the active setting's color temperature.



Fill-flash - used as the main or supplementary light. In low-light conditions, the flash acts as the main source of illumination and overpowers the ambient light. Under strong sunlight or in backlit situations, the fill-flash can reduce harsh shadows.



Red-eye reduction - used when taking photographs of people or animals in low-light conditions. The red-eye effect is caused by light reflected from the retina of the eye. The camera fires several pre-flashes before the main flash burst to contract the pupils of the subject's eyes.



REAR

Rear flash sync - used with long exposures to make trailing lights or blurring appear to follow rather than precede the subject. The effect is not apparent if the shutter speed is too fast and stops the subject's motion.

When the shutter is released, a pre-flash fires. This pre-flash is not for exposure, but for metering. The flash fires again just before the shutter closes.



WL

Wireless / Remote flash - allows the camera to control an off-camera flash unit without the need of a cable. See page 76.

WIRELESS / REMOTE FLASH



On-camera flash

Wireless/Remote flash allows the camera to control an off-camera Program/Maxxum 5600HS(D) and 3600HS(D) flash unit without the need of a cable. Single or multiple flash units can be placed around the subject to create different lighting effects.

Wireless/
Remote
flash



The camera's built-in flash fires to control the off-camera flash units rather than to illuminate the subject.

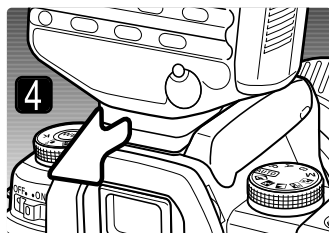
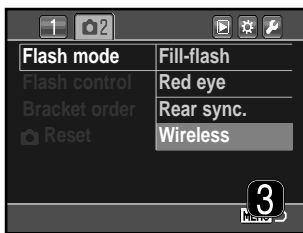
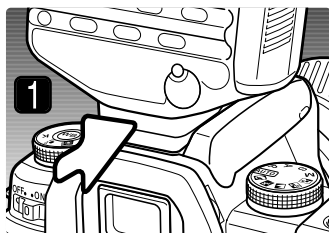

1. Remove the accessory shoe cap (p. 112) and slide a Program/Maxxum 5600HS(D) or 3600HS(D) flash on the accessory shoe until the safety lock engages.
2. Turn on the camera and flash unit.
3. Set the camera to the wireless flash mode in section 2 of the recording menu (p. 70). This simultaneously set a the flash to the wireless mode and sets the camera to the flash's wireless channel.
4. Press and hold the mounting-foot-release button on the flash unit to disengage the safety catch and remove the flash unit from the camera.

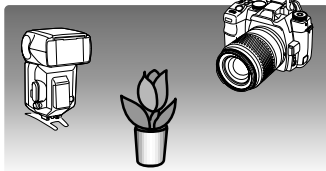

Raise the built-in flash on the camera and position the camera and flash around the subject. See the following page for operating ranges.

Make sure no objects come between the camera and flash unit. The flash units can be test fired by pressing the AEL button on the camera. AEL button setup in section 1 of the custom menu should be set to one of the hold options. If the flash does not fire, change the camera, flash, or subject position. The slow shutter sync is active in auto recording, P, A, and digital subject program exposure modes (p. 47).

When the 5600HS(D) and 3600HS(D) flash is charged, the AF illuminator on the front of the unit blinks. The viewfinder flash signal shows the status of the camera flash (p. 31). Take a picture as described in the basic recording section on page 28.

Wireless/Remote flash performs best under subdued light or interior lighting. Under bright light sources, the flash may not be able to detect the control signals from the camera's built-in flash.

When not using off-camera flash units, always turn off the wireless flash mode in section 2 of the recording menu, or inaccurate flash exposures will result. The 5600HS(D) and 3600HS(D) flash units can be reset simultaneously with the camera. Simply mount the flash unit in the accessory shoe and change the wireless flash mode setting on the menu to another flash mode.

High-speed sync. is available, see page 112. The Wireless/Remote Flash Controller is not compatible with this camera.

WIRELESS/REMOTE CAMERA AND FLASH RANGES

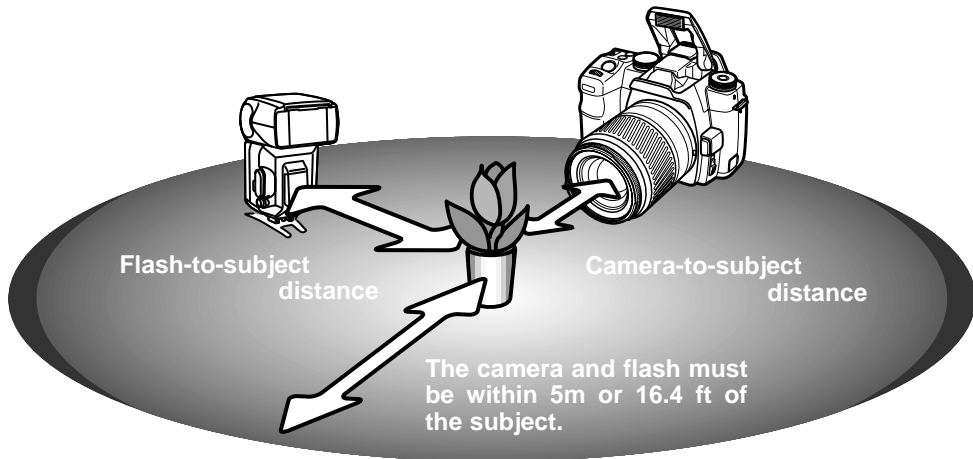

Specifications with Maxxum / Program flash 5600HS(D) at ISO 100

Aperture	Camera-to-subject distance	Flash-to-subject distance ²		
		Up to sync. speed ¹	1/250 second	1/1000 second
<i>f</i> /2.8	1.4 ~ 5m / 4.6 ~ 16.4ft	1 ~ 5m / 3.3 ~ 16.4ft	1 ~ 5m / 3.3 ~ 16.4ft	1 ~ 2.5m / 3.3 ~ 8.2ft
<i>f</i> /4.0	1 ~ 5m / 3.3 ~ 16.4ft	1 ~ 5m / 3.3 ~ 16.4ft	1 ~ 3.5m / 3.3 ~ 11.5ft	1 ~ 1.7m / 3.3 ~ 5.6ft
<i>f</i> /5.6	1 ~ 5m / 3.3 ~ 16.4ft	1 ~ 5m / 3.3 ~ 16.4ft	1 ~ 2.5m / 3.3 ~ 8.2ft	1 ~ 1.2m / 3.3 ~ 3.9ft

Specifications with Maxxum / Program flash 3600HS(D) at ISO 100¹

<i>f</i> /2.8	1.4 ~ 5m / 4.6 ~ 16.4ft	1 ~ 5m / 3.3 ~ 16.4ft	1 ~ 4m / 3.3 ~ 13.1ft	1 ~ 2m / 3.3 ~ 6.6ft
<i>f</i> /4.0	1 ~ 5m / 3.3 ~ 16.4ft	1 ~ 5m / 3.3 ~ 16.4ft	1 ~ 3m / 3.3 ~ 9.8ft	1 ~ 1.5m / 3.3 ~ 4.9ft
<i>f</i> /5.6	1 ~ 5m / 3.3 ~ 16.4ft	1 ~ 5m / 3.3 ~ 16.4ft	1 ~ 2m / 3.3 ~ 6.6ft	—

1. The camera's flash sync. speed is 1/125 sec. with Anti-Shake on and 1/160 sec. with Anti-Shake off. Shutter speeds up to this limit can be used.
2. Double the maximum distance when using the camera sensitivity at ISO 400. The maximum distance cannot exceed 5m or 16.4 ft.

FLASH CONTROL

ADI and pre-flash TTL flash control are available. Flash control is changed in section 2 of the recording menu (p. 70). The flash control used depends on the lens and flash combination.

ADI (Advanced Distance Integration) flash metering - combines distance information from D-series lenses with information from a pre-flash exposure. ADI metering is less influenced by subject reflectance.

The camera automatically switches from ADI metering to pre-flash TTL when the autofocus system is prevented from focusing. When using the Macro Twin Flash 2400 , Marco Ring flash 1200 or a wireless or off-camera flash unit, flash control is set to pre-flash TTL.

When using the Maxxum / Program Flash 2500(D), switch both the flash unit and camera to ADI metering.

Pre-flash TTL - calculates flash exposure with a pre-flash only. This mode must be used with close-up filters or filters that reduce the amount of light entering the camera such as neutral density filters. Pre-flash TTL must be used when a diffuser is attached to the built-in flash, the wide-angle adapter with the Maxxum / Program flash 3600HS(D), bounce flash with the Maxxum / Program Flash 2500(D), or an external flash unit.

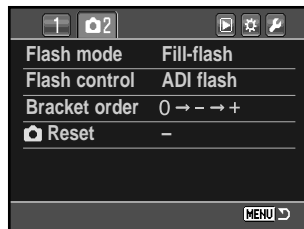

BRACKETING ORDER

The order in which exposure bracketing frames is captured is selected in section 2 of the recording menu (p. 70). For information on exposure bracketing, see page 52.

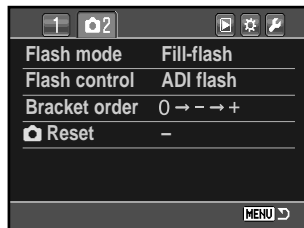

RECORDING MODE RESET

The recording mode functions can be reset in section 2 of the recording menu (p. 70). When selected, a confirmation screen appears; choosing “Yes” resets the following functions and settings, “No” cancels the operation.

Exposure compensation	±0.0	p. 48
Flash compensation	±0.0	p. 60
AF area	Wide AF area	p. 57
Focus area selection	Spot AF area	p. 57
AF mode	AF-A	p. 58
Metering mode	Multi-segment	p. 59
Drive mode	Single-frame advance	p. 50
Preset white balance	Daylight ±0	p. 65
Color temperature	5500K, 0 Green/Magenta shift	p. 67
Color mode	Natural	p. 61
Digital Effects Control (DEC)	All reset with all color modes	p. 63
Flash mode	Fill flash or red-eye reduction ¹	p. 75
Flash control	ADI	p. 79

1. The flash mode is reset to whichever of the two modes was last set.

ABOUT DiIMAGE MASTER

The full version of DiIMAGE Master gives you all the tools to organize, examine, and process your images. The Organizer window allows you to sort images quickly into four user-defined classifications. Outtakes can easily be hidden from view without the need to delete or remove them from the folder.

Is it difficult to decide which image is the best? The Examiner window allows you to compare up to four images for differences between color, exposure, white balance, and focus by sampling areas in each image.

The Photofinisher window has many features to process large numbers of images quickly. Jobs can be created for specific adjustments and applied to other images as well as used for batch processing. Processing can be simply cut and pasted from one picture to another.

A luminance limit can be specified on the histogram and displayed on an image to show the pixels which are approaching the black and white levels. The focus checker enlarges the image so sharpness can be determined. These tools are available in the Organizer, Examiner, and Photofinisher.

For more on the other features in DiIMAGE Master, visit us on the web.

North America

<http://kmpi.konicaminolta.us/>

Europe

<http://www.konicaminoltasupport.com>



Organizer

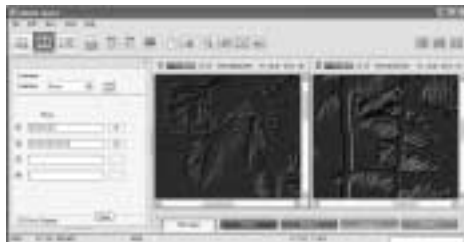

Focus Examiner

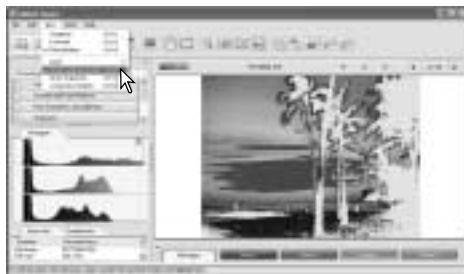

Photofinisher: Luminance Limit Display

PLAYBACK MENU

In playback mode, press the menu button to open and close the menu. The four-way keys of the controller move the cursor in the menu. Pressing the central button of the controller enters a setting.

NAVIGATING THE PLAYBACK MENU

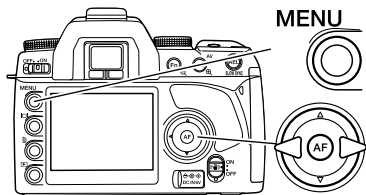

MENU

Activate the recording menu with the menu button. Tab 1 at the top of the menu is highlighted.

Use the left/right keys of the controller to highlight the appropriate menu tab; the menus change as the tabs are highlighted.



When the required menu section is displayed, use the up/down key to scroll through the menu options. Highlight the option whose setting needs to be changed.



Press the right controller key to display the settings; the current setting is indicated by an arrow. To return to the menu options, press the left key.



Use the up/down key to highlight the new setting. If “Enter” is displayed, press the central button of the controller to continue.



Press the central button of the controller to select the highlighted setting.

Once a setting has been selected, the cursor returns to the menu options and the new setting is displayed. Changes can continue to be made. To return to the playback mode, press the menu button.

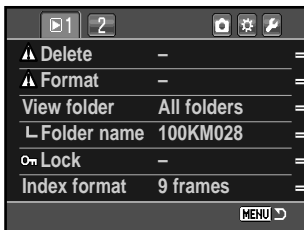

- To delete images on the memory card (p. 84).
- To format the memory card (p. 85).
- To select one or all folders to view in playback (p. 85).
- To select the folder to view in playback (p. 85).
- To protect images from deletion (p. 86).
- To specify the index playback format (p. 87).

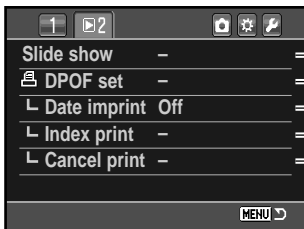

- To play back images automatically (p. 88)
- To select images for DPOF printing (p. 89).
- To print the date of capture with each print (p. 90)
- To create an index print with the DPOF order (p. 90)
- To cancel DPOF print orders on the memory card (p. 90).

FRAME-SELECTION SCREEN

When a marked-frames setting is chosen on a menu, the frame-selection screen appears so multiple files can be selected. The index format of the screen can be changed in section 1 of the playback menu (p. 87).



The left/right keys of the controller move the yellow border to select the image.



The up key selects the frame; when selected, an indicator appears on the thumbnail. The down key deselects the image removing the indicator.



Press the central button of the controller to complete the operation. Pressing the menu button cancels the screen and any operation made.

DELETE



Deleting permanently erases the image. Once deleted, an image cannot be recovered. Care should be taken when using the delete function.

Single, multiple, or all images in a folder can be deleted with the playback menu. Before an image is deleted, a confirmation screen appears; choosing “Yes” executes the operation, “No” cancels it. Only the images in the view-folder option in section 1 of the playback menu (p. 85) can be viewed and deleted with the marked frames and all-in-folder options. Delete has three options:

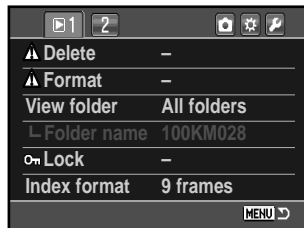

Marked frames - to delete multiple images. When this setting is chosen, the frame-selection screen (p. 83) is displayed. Use the left/right keys of the controller to highlight the first image to be deleted. Pressing the up key marks the thumbnail with the delete indicator. To deselect an image for deletion, highlight it with the yellow border and press the down key; the delete indicator disappears. Continue until all the images to be deleted are marked. Press the controller to continue (the confirmation screen appears), or press the menu button to cancel the operation and return to the playback menu. On the confirmation screen, highlighting and entering “Yes” deletes the marked images.

All in folder - to delete unlocked images in a single folder specified by the view-folder option.

All on card - all unlocked images on the card are deleted.

The delete function can only erase unlocked images. If an image is locked, it must be unlocked before it can be deleted.

Deleting a large amount of data from a large capacity memory card may take several minutes. In this case, use the camera’s format function or delete the data using a computer. Do not format the card with the computer.

FORMAT



When a memory card is formatted, all data on the card is erased.

The formatting function in section 1 of the playback menu is used to erase all data on a memory card. Before formatting a card, copy the data to a computer or storage device. Locking files will not protect them from being deleted when the card is formatted. Always format the memory card using the camera; never use a computer to format a card.

When the format option is selected and entered, a confirmation screen appears. Choosing “Yes” formats the card, choosing “No” cancels the operation. Never remove the card while it is being formatted. A screen appears to indicate the card has been formatted.

VIEW FOLDER

Only the images in the folders specified with the view-folder option in section 1 of the playback menu (p. 82) can be viewed or edited in playback. Two options are available:

All folders - to view and edit all images on the memory card.

Single folder - to view and edit images in a specific folder. The folder is selected in the folder-name option below the view-folder option.

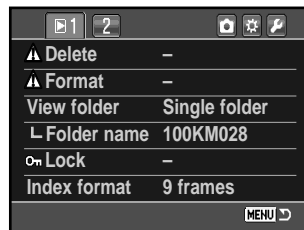

For more on memory card organization, see page 120. Folders can be created and selected in section 2 of the setup menu (p. 104, 105).

LOCK

Single, multiple, or all images on the memory card or in a folder specified with the view-folder option can be locked. A locked image cannot be deleted by either the playback menu functions or the delete button. Important images should be locked. Images are locked in section 1 of the playback menu (p. 82).

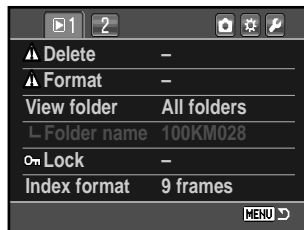

The lock has five options:

Marked frames - to lock or unlock multiple images. When this is chosen, the frame-selection screen (p. 83) is displayed. Use the left/right keys of the controller to highlight the image to be locked. Pressing the up key marks the thumbnail with the lock indicator. To unlock an image, highlight it with the yellow border and press the down key; the lock indicator disappears. Continue until all the images are marked. Press the controller to lock the marked frames, or press the menu button to cancel the operation and return to the playback menu.

All in folder - to lock images in a single folder specified by the view-folder option.

All on card - all images on the memory card are locked.

Unlock folder - to unlock images in a single folder specified by the view-folder option.

Unlock card - all images on the memory card are unlocked.

Locking an image protects it from a delete function. However, the formatting function erase all files on a memory card whether locked or not.

Locked images are indicated in the playback displays.



Lock indicator

INDEX PLAYBACK FORMAT

The index-format option in section 1 of the playback menu can specify a four, nine, and sixteen image display for index playback (p. 37) and frame-selection screens (p. 83). A file browser can also be used in place of the index playback display mode; a 9-frame display is used for the selection screens.

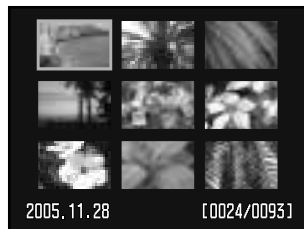

9-frame index

After selecting the file-browser option in the menu, press the display button in the playback mode to display the file browser.



The up/down keys of the controller switch between the folder tabs and images; a tab or image is highlighted.



The left/right keys of the controller select the folder tabs or images.



A folder and its contents or a single image can be deleted. With the folder tab or image thumbnail highlighted, press the delete button.



On the confirmation screen, use the left/right keys to highlight "Yes." "No" cancels the operation.



Press the controller to execute the command on the confirmation screen. If a folder contains locked images, the locked images and folder remain.

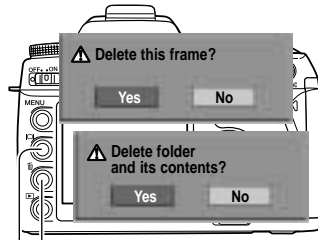

Delete button
Display button

SLIDE SHOW

Section 2 of the playback menu starts the slide-show function. This function automatically displays images every five seconds on the card or in the folder specified with the view-folder option in section 1 of the menu.

Highlight “Enter” in the slide-show option in section 2 of the playback menu and press the center of the controller to begin the slide-show playback.



Press the central button of the controller to pause and restart the presentation.



Use the left/right keys of the controller to advance to the next image or return to the previous one.



To cancel the presentation, press the down key of the controller or the menu button.

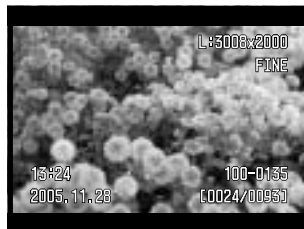

ABOUT DPOF

This camera is supported by DPOF™ version 1.1. The DPOF (Digital Print Order Format) allows direct printing of still images from digital cameras. After the DPOF file is created, the memory card is simply taken to a photofinishing service or inserted into the memory-card slot of DPOF compatible printers.

When a DPOF file is created, a misc. folder is automatically made on the memory card to store it (p. 120). DPOF print files cannot be made for RAW and embedded Adobe RGB images. Images using an Adobe RGB color mode may not be reproduced accurately (p. 61).

Images selected for printing are indicated in the playback displays. The number of copies is displayed next to the indicator.



Print indicator

DPOF SETUP

The DPOF-set option is used to set an order for standard prints from digital images. Single, multiple, or all images on the memory card or in a folder specified with the view-folder option can be printed (p. 85).

DPOF setup has three options:

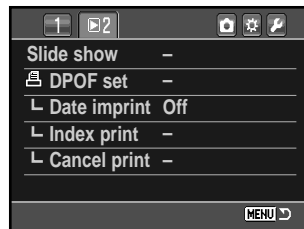

Marked frames - to choose a group of images to be printed or when the number of copies for each image varies. When selected, the frame-selection screen appears (p. 83). Use the left/right keys of the controller to highlight an image to be printed. Pressing the up key marks the image with the printer indicator. The number next to the indicator indicates the number of copies of that image will be printed. Pressing the up key increases the number of copies, pressing the down key decreases the number. A maximum of nine copies can be ordered. To deselect an image for printing, press the down key until the the number of copies reaches zero and the printer indicator disappears. Continue until all the images to be printed are marked. Press the controller to create the DPOF file, or press the menu button to cancel the operation and return to the playback menu.

All in folder - to select images in the folder specified by the view-folder option.

All on card - to select all images on the memory card for printing.

When the all-in-folder or all-on-card option is chosen, a screen appears requesting the number of copies of each image; a maximum of nine copies can be ordered. Use the up/down keys of the controller to set the number of copies. If the all-on-card option was used to create a print order, any additional images saved afterwards in the folder are not be included in the order.

DPOF files created with another camera are deleted when a DPOF file is created.

DATE IMPRINT

To print the date of capture with each image with a compatible DPOF printer, turn the menu option on. To cancel date imprint, simply turn the option off. How the date is printed varies with the printer. Not all printers support this function.

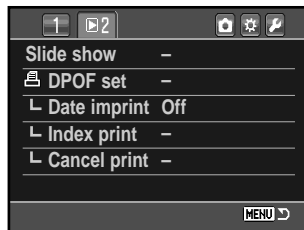

INDEX PRINT

To create an index print of all the images in the folder, set the option on. To cancel an index print, simply change the setting to off.

If an index-print order is created, any additional images saved afterwards in the folder are not included in the index print. The number of images printed per sheet differs between printers. The information printed with the thumbnails can vary.



CANCEL PRINT

After the pictures have been printed, the DPOF file remains on the memory card and must be canceled manually. The cancel-print option in section 2 of the playback menu deletes the DPOF files. When the setting is selected, a confirmation screen appears; choosing and entering "Yes" executes the operation and cancels the print and index-print order. Two options are available:

All frames C - To cancel all printing files on the memory card.

All frames F - To cancel the printing file in the folder specified by the view-folder option.

OPENING THE CUSTOM & SETUP MENUS

The custom and setup menus can be accessed from both the recording and playback modes. The buttons in the top right corner of the menus are links to the other camera menus. See page 92 for information on the custom menu and page 98 for the setup menu.



Open the menu and use the left/right keys of the controller to highlight the custom or setup buttons.



Press the central button to display the menu. Repeat the procedure to return to the original or different menu or press the menu button to close the menu.

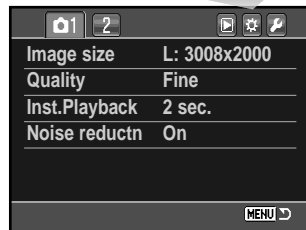
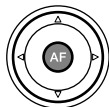

Camera Notes

The control dial moves the cursor left and right in the menus.

The menu section memory option in section 3 of the setup menu memorizes the last menu section opened and returns to that section when the menu button is pressed (p. 106).

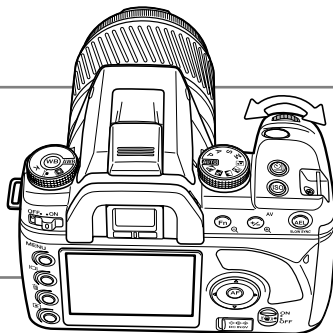

CUSTOM MENU

The custom menu controls operation preferences. See page 91 on how to open the custom menu.

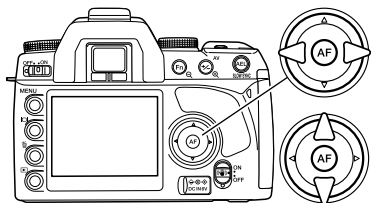

Use the left/right keys of the controller to highlight the appropriate menu tab; the menus change as the tabs are highlighted.

When the required menu section is displayed, use the up/down key to scroll through the menu options. Highlight the option whose setting needs to be changed.



Press the right controller key to display the settings; the current setting is indicated by an arrow. To return to the menu options, press the left key.



Use the up/down key to highlight the new setting.



Press the central button of the controller to select the highlighted setting.

Once a setting has been selected, the cursor returns to the menu options and the new setting is displayed. Changes can continue to be made.

Camera Notes

The control dial moves the cursor left and right in the menus.

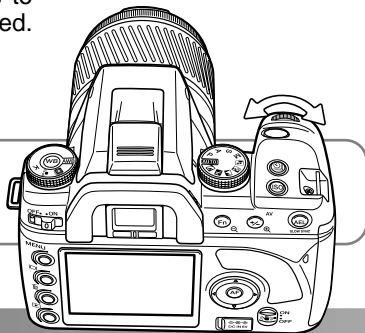

#1	2				To set AF or shutter-release priority (p. 93).
Priority setup	AF				To set the operation of a lens' focus-hold button (p. 94).
FocusHoldButt.	Focus hold				To set the operation of the AEL button (p. 94).
AEL button	AE hold				To specify exposure control with the control dial (p. 95).
Ctrl dial set	Shutter speed				To specify flash output with exposure comp. (p. 95).
Exp. comp. set	Ambient&flash				To turn the AF illuminator on and off (p. 96).
AF illuminator	On				

1	#2				To lock the shutter when no card is inserted (p. 96).
Shutter lock	On: no card				To lock the shutter when no lens is mounted (p. 96).
Shutter lock	On: no lens				To control the viewfinder AF-area illumination (p. 97).
AF area setup	0.3s. display				To control how the monitor is turned on and off (p. 97).
Monitor disp.	Automatic				To set the recording display orientation (p. 97).
Rec. display	Auto rotate				To set the playback display orientation (p. 97).
Play. display	Auto rotate				

AF/SHUTTER RELEASE PRIORITY SETUP

This custom function has two options:

AF - AF priority. The shutter will not release until the camera focuses.

Release - shutter-release priority. The shutter releases even if focus cannot be confirmed. The RP indicator is displayed on the monitor when this option is selected.



Release priority indicator

FOCUS-HOLD BUTTON SETUP

Some Konica Minolta lenses are equipped with a focus-hold button. The operation of this button can be specified in section 1 of the custom menu (p. 92). This custom function has two options:

Focus hold - pressing the focus-hold button on the lens locks the focus.

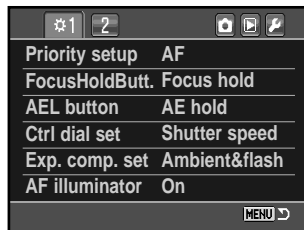

D.O.F. preview - pressing the focus-hold button previews the depth of field (p. 49). With non-D series lenses, this is active when the aperture and shutter speed are displayed.

AEL BUTTON SETUP

The operation of the AEL button (p. 46) can be specified in section 1 of the custom menu (p. 92). This custom function has four options:

AE hold - press and hold the AEL button to lock the exposure, release the button to unlock it. The metering mode set is used (p. 59).

AE toggle - press and release the AEL button to lock the exposure. The exposure remains locked even after the image is captured. Press and release the button again to unlock the exposure. The metering mode set is used (p. 59).

Spot AE hold - the spot metering area is used regardless of the metering-mode selected (p. 59). Press and hold the AEL button to lock the exposure, release the button to unlock it.

Spot AE toggle - the spot metering area is used. Press and release the AEL button to lock the exposure. The exposure remains lock even after the image is captured. Press and release the button again to unlock the exposure.

CONTROL-DIAL SETUP

The operation of the control dial in the auto recording, program, and manual exposure modes (p. 39) can be specified in section 1 of the custom menu (p. 92). This custom function has two options:

Shutter speed - this is the default setting. Descriptions in the manual are based on this.

When using program shift (p. 41), Ps is displayed as the exposure mode and the exposure is shifted based on the displayed shutter speed. If the lighting changes, the shutter speed remains fixed and the aperture changes for the exposure.

In manual exposure (p. 44), the control dial changes the shutter speed. Press and hold the exposure-compensation button and turn the control dial to change the aperture.

Aperture - When using program shift (p. 41), PA is displayed as the exposure mode and the exposure is shifted based on the displayed aperture. If the lighting changes, the aperture remains fixed and the shutter speed changes for the exposure.

In manual exposure (p. 44), the control dial changes the aperture. Press and hold the exposure-compensation button and turn the control dial to change the shutter speed.

EXPOSURE COMPENSATION SETUP

Exposure compensation setup is set in section 1 of the custom menu (p. 92). This custom function has two options:

Ambient & flash - when using exposure compensation with the flash, both the ambient and flash exposure controls are adjusted.

Ambient only - the flash exposure is fixed and only the ambient exposure controls (shutter speed, aperture, and camera sensitivity) adjust the exposure.

AF ILLUMINATOR

The built-in flash is used as an AF Illuminator. When the scene is too dark for the camera to focus, raise the built-in flash. It fires a few short bursts to provide light for the camera to focus. When an accessory flash is attached, the flash unit is used as the AF illuminator. The AF illuminator can be turned on and off in section 1 of the custom menu (p. 92).

The range of the AF Illuminator is approximately 1 to 5 m (3.3 to 16.4 ft.). It does not fire when using the continuous AF focus mode. The AF illuminator may not operate with focal lengths of 300mm or longer or with the 3x-1x Macro Zoom.

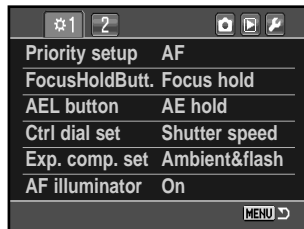
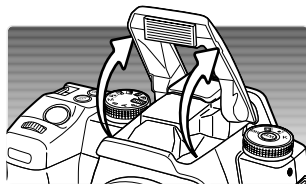

CARD SHUTTER LOCK

The card shutter lock prevents the shutter from releasing when no memory card is inserted in the camera. The shutter lock is turned on and off in section 2 of the custom menu (p. 92).

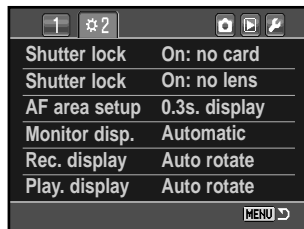

LENS SHUTTER LOCK

The shutter lock prevents the shutter opening and exposing the CCD to dust when no lens is mounted on the camera. Turn the shutter lock off when attaching the camera to a telescope or microscope. The shutter lock is turned on and off in section 2 of the custom menu (p. 92).

AF AREA SETUP

The spot focus or local AF areas are illuminated when the camera focuses. The illumination period is selected in section 2 of the custom menu (p. 92) between 0.3 seconds and 0.6 seconds. AF area illuminator activation can also be turned off.

AF area illuminator

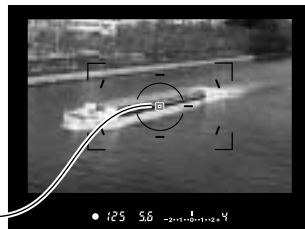

MONITOR DISPLAY SETUP

Automatic and manual monitor display is selected in section 2 of the custom menu (p. 92). The automatic option uses the viewfinder eye sensors to turn the monitor off when using the viewfinder. The manual option requires the monitor to be turned off using the display button (p. 33).

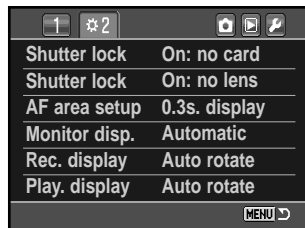

RECORDING DISPLAY SETUP

The auto-rotate and horizontal display is selected in section 2 of the custom menu (p. 92). The auto-rotate option automatically changes the recording display as the camera orientation is moved between horizontal and vertical positions. The horizontal option fixes the display to the horizontal position.

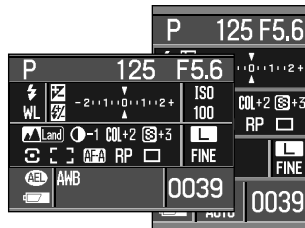

PLAYBACK DISPLAY SETUP

The auto-rotate and manual-rotate options are selected in section 2 of the custom menu (p. 92). The auto-rotate option records camera orientation with the image file so that it is displayed correctly with the camera and DiMAGE Master Lite. The manual option does not tag images. When the manual option is selected, previously recorded images are not affected and are rotated when played back.



SETUP MENU

The setup menu controls camera operation. See page 91 on how to open the setup menu.

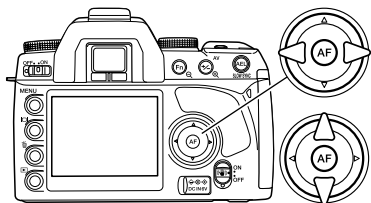

Use the left/right keys of the controller to highlight the appropriate menu tab; the menus change as the tabs are highlighted.

When the required menu section is displayed, use the up/down key to scroll through the menu options. Highlight the option whose setting needs to be changed.



Press the right controller key to display the settings; the current setting is indicated by an arrow. To return to the menu options, press the left key.



Use the up/down key to highlight the new setting. If “Enter” is displayed, press the central button of the controller to continue.



Press the central button of the controller to select the highlighted setting.

Once a setting has been selected, the cursor returns to the menu options and the new setting is displayed. Changes can continue to be made.

Camera Notes

The control dial moves the cursor left and right in the menus.

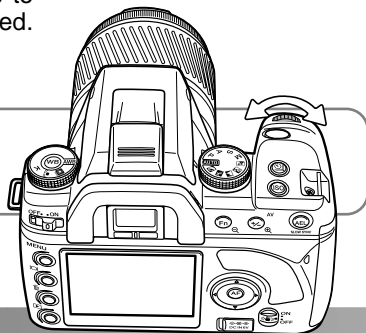

1	2	3				
LCDbrightness	-					To set monitor brightness (p. 100).
Transfer mode	Data storage					To specify camera operation with a computer (p. 100).
Video output	NTSC					To switch video output between NTSC and PAL (p. 101).
Audio signals	On					To change or turn off audio signals (p. 102).
Language	English					To set the menu language (p. 102).
Date/Time set	-					To set the camera's clock and calendar (p. 103).
MENU >						

1	2	3				
File # memory	Off					To activate file number memory (p. 103).
Folder name	Std. form					To select the folder name format (p. 104).
Select folder	100KM028					To select the destination folder for recorded images (p. 104).
New folder	-					To create a new folder (p. 104).
MENU >						

1	2	3				
LCD backlight	5 sec.					To specify monitor backlight illumination period (p. 105).
Power save	3 min.					To set the auto-power-save period (p. 105).
MenuSec.Memory	Off					To memorize the last menu section opened (p. 106).
Delete conf.	"No"					To change the confirmation screen's default setting (p. 106).
Clean CCD	-					Read cleaning instructions before using (p. 106).
Reset default	-					To reset camera functions (p. 108).
MENU >						

LCD BRIGHTNESS

Monitor brightness is adjusted in section 1 of the setup menu. Highlight “Enter” and press the central button of the controller to open the LCD brightness setup screen.



Brightness is controlled in eleven levels. Use the left/right controller keys to adjust the brightness, the monitor adjusts accordingly.



Press the central button of the controller to set the level and complete the operation. Press the menu button to close the screen without applying any changes.

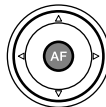

TRANSFER MODE

The data-transfer mode must be specified depending on whether the camera is used to transfer data to a computer or print images with a PictBridge compatible printer. Select the appropriate option:

Data storage - to transfer data between the camera and a computer. This option must be selected when moving image files to a computer or when using the DiMAGE Master Lite software.

PTP - to print images with a PictBridge compatible printer. See page 126 for more on PictBridge.

VIDEO OUTPUT

Camera images can be displayed on a television. The video output can be changed between NTSC and PAL. North America uses the NTSC standard and Europe uses the PAL standard. Check which standard is used in your region to play back images on your television set.

VIEWING IMAGES ON A TELEVISION

It is possible to view camera images on your television. The camera has a video-out terminal which can be used to connect the camera to a television using the supplied video cable.

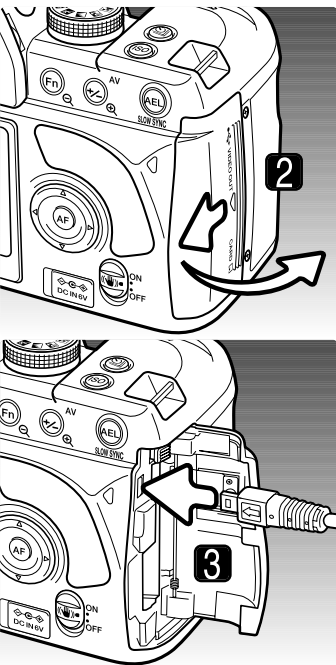

1. Turn off the television and the camera.
2. Slide the card-slot door toward the back of the camera to release the safety catch and open.
3. Insert the plug of the video cable into the camera's video-out terminal.
4. Plug the other end of the video cable into the video input terminal on the television.
5. Turn the television on.
6. Change the television to the video channel.
7. Turn on the camera and press playback button. The camera's monitors do not activate when the camera is attached to a television. The playback-mode display is visible on the television screen.
8. View images as described in the playback section. Because of the broadcast standard used to display television images, image quality and resolution will appear lower than when displayed on a computer monitor.

AUDIO SIGNALS

When the shutter-release button is pressed partway down, an audio signal gives a positive confirmation the AF system has focused. This signals can be turned off in section 1 of the setup menu (p. 98).

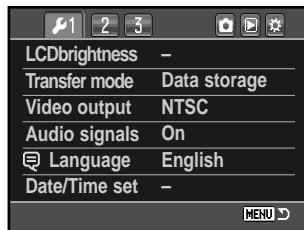

LANGUAGE

The language used in the menus can be changed. Highlight the current language and press the center of the controller to open the language setup screen.



Use the four-way keys of the controller to select the menu language.



Press the central button of the controller to set the language. Press the menu button to close the screen without making any changes.

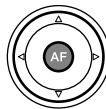

DATE AND TIME SETUP

It is important to accurately set the clock. When a still image is recorded, the date and time of the recording are saved with the image and are displayed during playback or can be read with the DiIMAGE Master Lite software. When the Date/Time-set option is selected and entered in section 1 of the setup menu, the date/time screen is displayed.

Use the left/right keys of the controller or rear control dial to select the item to be changed.



Use the up/down keys or front control dial to change the item.



Press the central button of the controller to complete the operation.

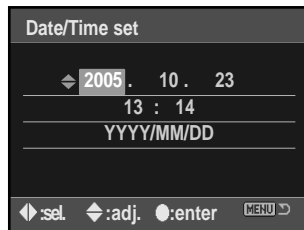

FILE NUMBER (#) MEMORY

When file number memory is selected, if a new folder is created, the first file stored in the folder will have a number one greater than the last file saved. This allows multiple folders to be created, but the image file numbers will be in the order in which they were shot. If the file number memory is disabled, the image file name will have a number one greater than the last image saved in the folder.

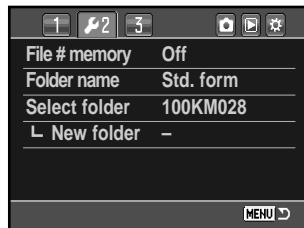

If file number memory is active and the memory card is changed, the first file saved to the new card will have a number one greater than the last file saved on the previous card if the new card does not contain an image with a greater file number. If it does, the file number of the new image will be one greater than the greatest on the card.

FOLDER NAME

All recorded images are stored in folders on the memory card. Folder names come in two formats: standard and date.

Standard folders have an eight character name. The initial folder is named 100KM028. The first three digits are the folder's serial number, which increases by one each time a new folder is created. The next two letters refer to Konica Minolta, and the last three numbers indicate the camera used; 028 indicates a Maxxum/Dynax 5D.

A date folder name also starts with the three digit serial number and is followed by one register for the year, two register for the month, and two registers for the day: 100YMMDD. The folder 10150801 was created in 2005 on August 1st.

With the date folder format selected, when an image is recorded a new folder with the day's date is created. All images recorded that day are placed in that folder. Images recorded on a different day are placed in a new folder with the corresponding date. When a new folder is created, the serial number in the image-file name is reset to 0001 unless file number memory is active. For more information on folder organization and file names, see page 120.

SELECT FOLDER

This option specifies in which folder images are saved. Only folders with a standard folder name can be selected. If the date folder name option is used, images are placed in a folder with the corresponding date of recording. Select folder is in section 2 of the setup menu (p. 98).

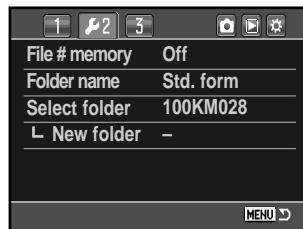

NEW FOLDER

This allows the creation of new folders. The folder-name option in section 2 of the setup menu specifies the folder-name format. If multiple date-format folders are created, only the last folder can be used for storing images.

Highlight “Enter” and press the center of the controller to create a new folder.

The new folder name is displayed briefly. Every time a new folder is created, the folder number increases automatically by one greater than the highest folder number on the memory card.



LCD BACKLIGHT

The LCD monitor backlight turns off to conserve power after a certain period. Press a camera button to restore the display. This period can be set to 5, 10, 30, or 60 seconds in section 3 of the setup menu (p, 98).

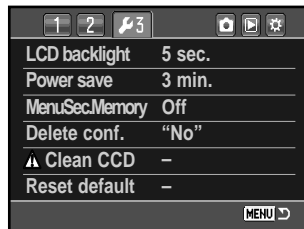

AUTO POWER SAVE

The camera shuts down to conserve battery power if no operation is made within a certain period. The length of this period can be changed to 1, 3, 5, 10, or 30 minutes. To restore power, press the shutter-release button partway down. When the camera is connected to the computer, the auto-power-save period is set to ten minutes. This period cannot be changed.

MENU SECTION MEMORY

The camera can remember which menu section was last opened. If the menu section memory function is on, when the menu button is pressed, the last menu section that was last displayed is opened. When menu section memory is off, section 1 of the recording or playback menu is displayed when the menu button is pressed.

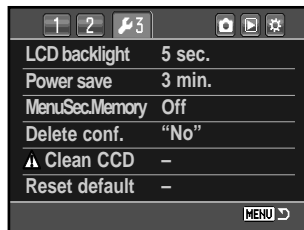

DELETE CONFIRMATION

Each time a delete command is used a confirmation screen appears confirming the action to erase the image data. When this screen opens, the no button is highlighted. This function allows the yes button to be initially highlighted to make deleting images easier. Care should be taken when deleting images as the data cannot be retrieved once erased.

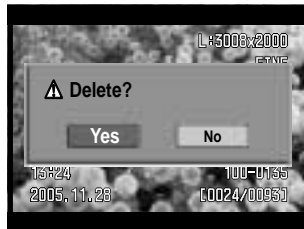

CLEAN CCD



Only clean the CCD when necessary. Improper cleaning may damage the CCD.

Dust can enter the camera body when changing lenses. The camera should have a lens or body cap mounted at all times. Confirm the rear of the lens and cap is free from dust before mounting on the body.

Clean the CCD in a dust-free environment. Use a blower brush to remove the dust - compressed air can damage the camera.

Accessory Notes

The optional DiIMAGE Master software can remove the affects of dust from RAW images. This is done by taking a dust reference image before cleaning the CCD. For more on the full version of DiIMAGE Master, see page 81 or visit us on the web.

The battery should be fully charged before cleaning the CCD. If battery power is low, this function cannot be used. The use of the optional AC adapter is recommended over the use of the battery. Cleaning the CCD without sufficient power will cause permanent damage.

Highlight “Enter” and press the center of the controller to begin the cleaning routine.

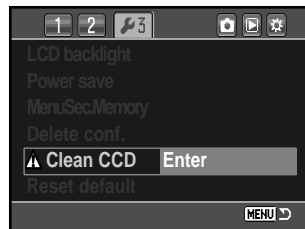

Before the CCD is exposed, a confirmation screen appears; choosing “Yes” executes opens the shutter and mirror, “No” cancels the cleaning operation.

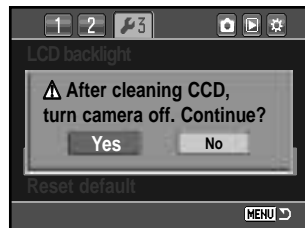

Remove the lens or body cap.

Use a blower brush to clean the CCD. Hold the body so it is leaning forward to prevent the dust blown from the CCD resettling in the camera. Do not touch the interior of the camera. If the camera starts beeping, power is low. Immediately stop cleaning and turn the camera off.

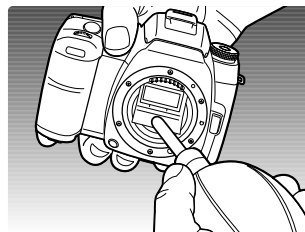

Turn the camera off to complete the operation. Replace the lens or body cap.

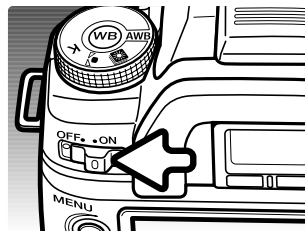

RESET DEFAULT

This option resets all camera modes and menus. When selected, a confirmation screen appears; choosing “Yes” resets the following functions and settings, “No” cancels the operation.

Recording and Playback mode		
Recording display	Full display	p. 33
Playback display	Single frame	p. 37
Drive mode	Single-frame advance	p. 50
Exposure compensation	±0.0	p. 48
Flash compensation	±0.0	p. 60
Camera sensitivity	ISO 100 (auto in auto recording)	p. 54
AF area	Wide focus area	p. 57
AF mode	AF-A	p. 58
Metering mode	Multi segment	p. 59
Color mode	Natural	p. 61
Digital Effects Control	Reset	p. 63
Preset white balance	Daylight ±0	p. 65
Custom white balance	Reset (Daylight)	p. 66
Color temperature	5500K, green/magenta shift reset	p. 67
Recording menu		
Image size	L: 3008 x 2000	p. 72
Image quality	Fine	p. 72
Instant playback	2 seconds	p. 74
Noise reduction	On	p. 74
Flash mode	Fill flash	p. 75
Flash control	ADI	p. 79
Bracketing order	Normal, underexpose, overexpose	p. 80

Playback menu			
View folder	All folders		p. 85
Index format	9 frame		p. 87
Date imprint	Off		p. 90
Custom menu			
AF/Shutter-release priority setup	AF priority		p. 93
Focus-hold button setup	Focus hold		p. 94
AEL button setup	AE hold		p. 94
Control-dial setup	Shutter speed		p. 95
Exposure compensation setup	Ambient & flash		p. 95
AF illuminator	On		p. 96
Card shutter lock	On		p. 96
Lens shutter lock	On		p. 96
AF area setup	0.3 second display		p. 97
Monitor display setup	Automatic		p. 97
Recording display setup	Auto rotate		p. 97
Playback display setup	Auto rotate		p. 97
Setup menu			
LCD brightness	Reset		p. 100
Transfer mode	Data storage		p. 100
Audio signal	On		p. 102
File number memory	Off		p. 103
Folder name	Standard form		p. 104
LCD backlight period	5 seconds		p. 105
Auto-power-save period	3 minutes		p. 105
Menu section memory	Off		p. 106
Delete confirmation	"No"		p. 106

ACCESSORY NOTES

This section contains operation and compatibility information with camera accessories. Please read it in its entirety to achieve the best results with your camera.

LENS COMPATIBILITY

All Konica Minolta AF lenses are compatible with this camera. MD and MC series lenses cannot be used. For our current line of lenses, contact your Konica Minolta dealer.

The AF Macro Zoom 3X - 1X f/1.7-2.8 cannot be used with Anti-Shake (p. 32); turn Anti-Shake off. If a lens is equipped with a macro release, the release cannot be used with Anti-Shake. Focus range limiters set to a range that does not include infinity cannot be used. The focus range limiter on the SSM-series or D-series macro lenses can be used at any set range. Anti-Shake may not work with products made by another manufacturer.

LENS SHADOWING

Lens shadowing occurs when the lens or lens hood blocks part of the output from the built-in flash. Lens shadowing appears as a semi-circular shadow at the bottom (horizontal pictures) or side (vertical pictures) of the image. Remove the lens hood before using the built-in flash. Focus distance must be 1m / 3.3ft or greater. The built-in flash can not be used with the AF 600mm f/4 Apo G(HS).

FOCAL-LENGTH CONVERSION

Because the CCD is smaller than a 35mm frame, the angle of view obtained at a specific focal length is not the same. To calculate the approximate equivalent 35mm focal length, multiply the focal length in use by 1.5. A 100mm lens gives about the same angle of view as a 150mm lens on a 35mm camera.

CCD-PLANE

For some technical photographic applications such as macro photography, the position of the CCD plane is necessary. The illustration shows the approximate location of the CCD plane.

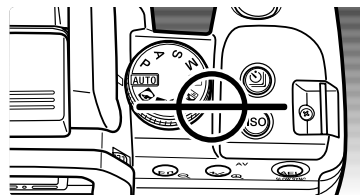

ATTACHING THE EYEPIECE CAP

The supplied eyepiece cap prevents light from entering through the viewfinder and affecting the exposure meter or fogging the image when using the self-timer or during long exposures.

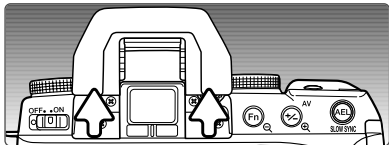

Carefully slide the eyepiece cup from around the viewfinder frame by pushing on each side of the cap.

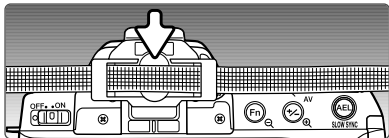

Slide the eyepiece cap over the viewfinder. The cap should be attached to the camera strap to prevent loss. Replace the eyepiece cup after the exposure.

OPTIONAL VIEWFINDER ACCESSORIES

The Angle Finder Vn and Magnifier Vn can be used with this camera. The Angle Finder makes using the camera at low angles easier. The Magnifier enlarges the center of the viewfinder image for critical focusing especially for macro photography. These accessories are mounted on the viewfinder frame as described above. For more information on these and other accessories, contact your Konica Minolta dealer.

ATTACHING A REMOTE CORD

The optional remote cords (RC-1000S or RC-1000L) can be used to reduce vibrations from touching the camera during long exposures. Open the remote-control terminal cover from the right. The cover is attached to the body to prevent loss; take care not to sever the connector. Insert the plug of the remote cord into the terminal (1).

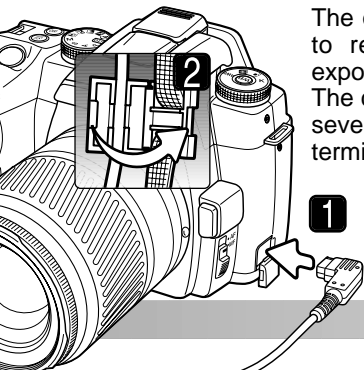

The cord can be attached to the camera strap. Open the remote-cord clip on the strap and push the cord into the groove. Close the clip until it clicks into place (2).

ATTACHING AN ACCESSORY FLASH UNIT

To extend the versatility of the camera, an accessory flash unit (sold separately) can be used. Always remove the accessory flash when the camera is not in use, and replace the accessory-shoe cap to protect the contacts.

Slide the accessory-shoe cap off as shown. Mount the flash unit on the accessory shoe by sliding it forward until it stops.

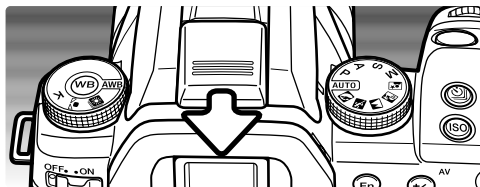

FLASH COMPATIBILITY

The following flash units are compatible with this camera:

- Maxxum/Program Flash 2500(D)
- Maxxum/Program Flash 3600HS(D)
- Maxxum/Program Flash 5600HS(D)
- Macro Ring Flash 1200 with Macro Flash Controller
- Macro Twin Flash 2400 with Macro Flash Controller

HIGH-SPEED SYNC. (HSS)

This camera is compatible with the High Speed Sync. (HSS) function in the Program/Maxxum Flash 5600HS(D) and 3600HS(D). This allows the camera to use its full range of shutter speeds up to 1/4000 second. HSS cannot be used with the 2-second self-timer drive mode nor the rear sync. flash mode.

Attach a compatible flash unit to the camera. Set the flash unit to HSS. When the shutter speed exceeds the camera sync. speed, the High Speed Sync. indicator (H) is displayed on the monitor and in the viewfinder.

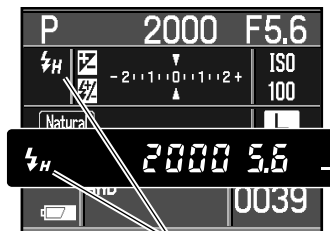

High Speed Sync. indicator

PC FLASH ADAPTER PCT-100

The PC Flash Adapter PCT-100 allows a studio or location flash system to be connected to the camera with a standard PC cord. The adapter is compatible with both center positive (normal polarity) and center negative (positive polarity) flash units with a voltage of 400V or lower. The software upgrade included with the PCT-100 should not be used.

To ensure correct exposures, use the manual exposure mode. Set the shutter speed equal to or slower than the flash duration; refer to the flash unit's instruction manual. The camera's flash-compensation function has no effect on the flash exposure. To make an exposure bracket, press and hold the AEL button during the bracketing series to control the exposure with the aperture rather than the shutter speed.

The use of custom white balance is recommended. When calibrating the camera, use the shutter speed and aperture settings require for the final exposure. A gray card may have to be used as the reference target with powerful flash units to reduce the intensity of the illumination. If custom white balance is not practical, use the preset daylight or flash setting or set the color temperature to the flash unit's color temperature if known; auto white balance is not recommended.

ABOUT THE BATTERY CHARGER CORD

The included AC cord is designed for the current of the sales region. Only use the cord in the region it was purchased.

Region	Product code
Continental Europe, Korea, Singapore (220-240V)	APC-150
Great Britain, Hong Kong (220V-240V)	APC-160
United States, Canada, Japan, Taiwan (100V-120V)	APC-170
China (220-240V)	APC-151
Australia (220-240V)	APC-230

Accessory Notes

The External High-Power Battery Pack Kit EPB-100 is not compatible with this camera.

DATA-TRANSFER MODE

Read this section carefully before connecting the camera to a computer. This manual does not cover the basic operation of computers or their operating systems; please refer to the manual supplied with your computer.

SYSTEM REQUIREMENTS

For the camera to be connected directly to the computer and used as a mass-storage device, the computer must be equipped with a USB port as a standard interface. The computer and the operating system must be guaranteed by their manufacturers to support USB interface. The following operating systems are compatible with the camera:

Windows 98, 98SE, Me, 2000 Professional, and XP

Macintosh OS 9.0 ~ 9.2.2 and Mac OS X 10.1.3 ~ 10.1.5, 10.2.1 ~ 10.2.8, 10.3 ~ 10.3.9, 10.4 ~ 10.4.1

Compatibility with Windows XP is with the home or professional editions only. Check the Konica Minolta web site for the latest compatibility information:

North America: <http://www.konicaminolta.us/>

Europe: <http://www.konicaminoltasupport.com>

Users with Windows 98 or 98 second edition will need to install the driver software on the included Digital Camera Software CD-ROM (p. 116). No special driver software is required for other Windows or Macintosh operating systems.

Customers who have bought a previous DiIMAGE or Dynax / Maxxum digital camera and have installed the Windows 98 driver software must repeat the installation procedure. The updated version of the driver software included on the supplied Digital Camera Software CD-ROM is required for the operation of the this camera with a computer. The new software will have no affect on the performance of previous cameras.

A remote camera driver is supplied in the Windows edition of the Digital Camera Software CD-ROM. This driver is not compatible with this camera.

CONNECTING THE CAMERA TO A COMPUTER

A fully charged battery should be used when the camera is connected to a computer. The AC adapter (sold separately) is recommended over the use of batteries. For users with Windows 98, read the section on how to install the necessary driver before connecting the camera to a computer.

1. Confirm the data-transfer option in section 1 of the setup menu is set to "Data storage" (p. 98). Turn the camera off.
2. Start up the computer. The computer must be on before connecting the camera.
3. Slide the card-slot door toward the back of the camera to release the safety catch and open. Attach the smaller plug of the USB cable to the camera. The plug should be firmly attached.
4. Attach the other end of the USB cable to the computer's USB port. The plug should be firmly attached. The camera should be connected directly to the computer's USB port. Using a USB hub may prevent proper operation.
5. With a memory card inserted, turn on the camera. A screen appears to indicate the start of the connection process. When the connection is made, the camera's monitors turn off. To change the card while the camera is connected to a computer, see page 124.

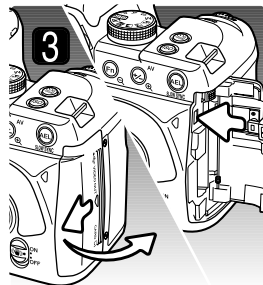

Initializing USB connection.

5



Desktop: Mac OS



My Computer: Windows

With the camera properly connected to Windows XP or Mac OS X, a window may open to download image data; follow the instructions in the window. A drive icon, or volume, appears in My Computer or on the desktop; the volume name varies with memory card and operating system. If the volume does not appear, disconnect the camera, restart the computer, and repeat the procedure.

CONNECTING TO WINDOWS 98 / 98 SECOND EDITION

The driver needs only to be installed once. If the driver cannot be installed automatically, it can be installed manually with the operating system's add-new-hardware wizard; see the instructions on the following page. During installation, if the operating system requests the Windows 98 CD-ROM, insert it into the CD-ROM drive and follow the accompanying instructions on the screen. No special driver software is required for other Windows operating systems.

AUTOMATIC INSTALLATION



Before connecting the camera to the computer, place the Digital Camera Software CD-ROM in the CD-ROM drive. The Digital Camera Software installer launcher opens. To automatically install the Windows 98 USB driver, click on the "Install the Windows 98 USB Mass-Storage Driver" button. A window appears to confirm that the driver should be installed; click "Yes" to continue.



When the driver has been successfully installed, a window appears. Click "OK." Restart the computer before connecting the camera (p. 115).



Manual installation

To install the Windows 98 driver manually, follow the instructions in the connecting-the-camera-to-a-computer section on page 115.

When the camera is plugged into the computer, the operating system will detect the new device and the add-new-hardware wizard window opens. Place the Digital Camera Software CD-ROM in the CD-ROM drive. Click “Next.”



Choose the recommended search for a suitable driver. Click “Next.”



Choose to specify the location of the driver. The browse window can be used to indicate the driver location. The driver should be located in the CD-ROM drive at :\\Win98\\USB. When the location is shown in the window, click “Next.”



The add new hardware wizard confirms the location of the driver. One of three drivers may be located: MNLVENUM.inf, USBPDR.inf, or USBSTRG.inf. The letter designating the CD-ROM drive varies between computers. Click “Next” to install the driver in the system.

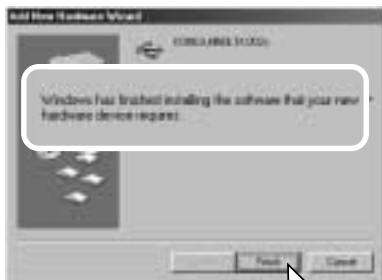

The last window confirms the driver has been installed. Click “Finish” to close the add new hardware wizard. Restart the computer.

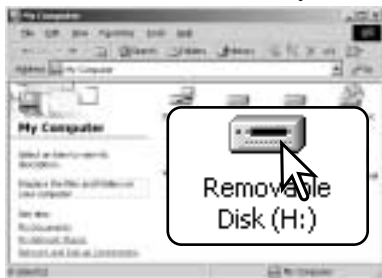

When the my-computer window is opened, a new removable-disk icon is displayed. Double click on the icon to access the camera’s memory card; see page 120.

AUTO POWER SAVE (DATA-TRANSFER MODE)

If the camera does not receive a read or write command within ten minutes, it shuts down to save power. When the camera shuts down, an unsafe-removal-of-device warning may appear on the computer monitor. Click "OK." Neither the camera or computer will be damaged in this operation.

Unplug the USB cable and turn off the camera. Remake the USB connection by reattaching the cable and turning the camera on.

Konica Minolta History

On February 20th, 1962, John Glenn became the first American to orbit the Earth. On board his Friendship 7 spacecraft was a Minolta Hi-matic camera to record that historic event. The 4 hour, 55 minute, and 23 second flight orbited the Earth three times at an average speed of 28,000 kph (17,500 mph).

Mr. Glenn visited our Sakai camera factory in Japan on May 24th, 1963 to plant a palm tree to celebrate the occasion. The palm tree is still in the courtyard of the factory and stands over eight meters tall (26ft).

The camera? It was not lost. It is on display at the Smithsonian Institution's National Air and Space Museum in Washington D.C. This and other objects from John Glenn's Friendship 7 Mercury flight can be found in galley 210, "Apollo to the Moon."



MEMORY CARD FOLDER ORGANIZATION



Drive Icon

Once the camera is connected to the computer, image files can be accessed by double clicking on icons. Image folders are located in the DCIM folder. To copy images, simply drag and drop the file icon into a location in the computer.



Dcim



Misc

The misc. folder contains DPOF print files (p. 88).

Files and folders on the memory card can be deleted using the computer. Changing file names or adding other types of data to the card with a computer may cause the camera to malfunction.



100KM028



10150801

From left to right: standard folder and date folder (p. 104).



PICT0001.MRW



PICT0001.THM
RAW image



PICT0002.JPG

Extra fine, fine,
or standard
image



PICT0003.JPE



PICT0003.THM
Extra fine, fine,
or standard
embedded
Adobe RGB
image



_ICT0004.JPG

Extra fine, fine,
or standard
Adobe RGB
image

Image file names begin with “PICT” followed by a four-digit file number and a mrw, jpg, jpe, or thm extension. The thumbnail images (thm) are used in camera and DiMAGE Master Lite operation. If a RAW or JPEG image uses the Adobe RGB color mode without an embedded profile, the file name begins with “_ICT.”

When a new folder is created, the first three digits in the folder name is one greater than the largest folder number on the card. When the file number in the image file name exceeds 9,999, a new folder is created with a number one greater than the greatest folder number on the memory card: e.g. from 100KM028 to 101KM028.

The file number on the image file may not correspond to its frame number on the camera. As images are deleted in the camera, the frame counter adjust itself to show the number of images on the card and reassign the frame numbers accordingly. The file numbers on the image files do not change when an image is deleted. When a new image is recorded, it is assigned a number one greater than the largest file number in the folder. File numbers can be controlled with the file-number-memory function in section 2 of the setup menu (p. 103).

Camera Notes

Image files contain exif tag data. This data includes the time and date the image was recorded as well as the camera settings used. This data can be viewed with the camera or the DiMAGE Master and DiMAGE Master Lite software.

If a camera image is opened in an image-processing application that does not support Exif tags, and then the image is saved overwriting the original data, the Exif tag information is erased. Some Exif compatible applications rewrite the Exif data preventing DiMAGE Master Lite from reading it. When using software other than DiMAGE Master or DiMAGE Master Lite, always rename the image file to protect the exif tag data.

To view images correctly on your computer, the monitor's color space may need to be adjusted. Refer to your computer manual on how to calibrate the display to the following requirements: sRGB, with a color temperature of 6500K, and a gamma of 2.2.

DISCONNECTING THE CAMERA FROM THE COMPUTER



Never disconnect the camera when the access lamp is lit - the data or memory card may permanently be damaged.

WINDOWS 98 / 98 SECOND EDITION

Confirm the access lamp is not lit. Turn off the camera and then disconnect the USB cable. If Kodak EasyShare is open, quit the application before disconnecting the camera.

WINDOWS XP, 2000 PROFESSIONAL, AND ME



To disconnect the camera, click once on the unplug-or-eject-hardware icon located on the task bar. A small window opens indicating the device to be stopped.

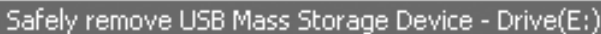

Safely remove USB Mass Storage Device - Drive(E:)

A small rectangular window is shown on a taskbar. It has a title bar with the text 'Safely remove USB Mass Storage Device - Drive(E:)'. A mouse cursor is pointing at the bottom right corner of the window.

9:56 AM

Click on the small window to stop the device; the safe-to-remove-hardware message appears. Disconnect the USB cable.



Safe To Remove Hardware

A dialog box with a title bar containing an information icon, the text 'Safe To Remove Hardware', and a close button. The main text reads: 'The 'USB Mass Storage Device' device can now be safely removed from the system.' There is a trash can icon in the background.

The 'USB Mass Storage Device' device can now be safely removed from the system.

ycle Bin

10:02 AM



When more than one external device is connected to the computer, repeat the procedure above except right click on the unplug-or-eject-hardware icon to open the unplug-or-eject-hardware window.

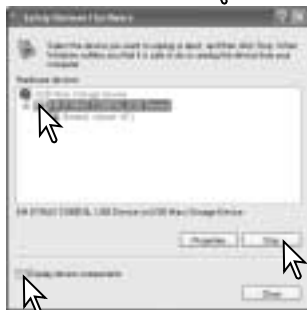

The hardware devices connected to the system are displayed. Click the display-device-components check box. Highlight the device to be stopped by clicking on it then click "Stop."

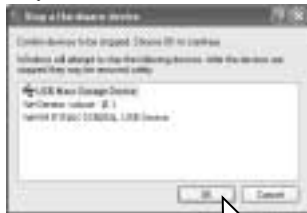

A confirmation screen appears to indicate the devices to be stopped. Clicking "OK" stops the device.



The safe-to-remove-hardware message appears. Disconnect the USB cable.



MACINTOSH

Confirm that the access lamp is not lit and then drag the mass-storage device icon and drop it into the trash. Disconnect the USB cable.

CHANGING THE MEMORY CARD (DATA-TRANSFER MODE)



Care should be taken when changing memory cards while the camera is attached to the computer. Data could be lost or damaged if the camera is not properly disconnected. Always confirm the access lamp is out before removing the memory card.

WINDOWS 98 / 98 SECOND EDITION

1. Turn off the camera.
2. Change the memory card.
3. Turn on the camera to remake the USB connection.

If Kodak EasyShare is open, quit the application before turning off the camera.

WINDOWS ME, 2000 PROFESSIONAL, AND XP

1. Stop the USB connection using the unplug-or-eject-hardware routine (p. 122).
2. Turn off the camera.
3. Change the memory card.
4. Turn on the camera to remake the USB connection.

MACINTOSH

1. Stop the USB connection by dragging the drive icon into the trash (p. 123).
2. Turn off the camera.
3. Change the memory card.
4. Turn on the camera to remake the USB connection.

REMOVING THE DRIVER SOFTWARE - WINDOWS

1. Insert a memory card in the camera and connect it to the computer with the USB cable. Other devices must not be connected to the computer during this procedure.
2. Right click on the My-computer icon. Select “properties” from the drop-down menu.

Windows XP: from the start menu go to the control panel. Click on the performance and maintenance category. Click “System” to open the system properties window.

3. Windows 2000 and XP: select the hardware tab in the properties window and click the device-manager button.

Windows 98 and Me: click the device-manager tab in the properties window.

4. The driver file will be located in the universal-serial-bus-controller or other-devices location of the device manager. Click on the locations to display the files. The driver should be indicated with Konica Minolta, the camera name, or “USB Mass Storage Device.” Under certain conditions, the driver name may not contain these names. However, the driver will be indicated by either a question mark or exclamation point.
5. Click on the driver to select it.
6. Windows 2000 and XP: click on the action button to display the drop-down menu. Select “uninstall.” A confirmation screen will appear. Clicking “Yes” will remove the driver from the system.

Windows 98 and Me: click the remove button. A confirmation screen will appear. Clicking “Yes” will remove the driver from the system.

7. Disconnect the USB cable and turn off the camera. Restart the computer.

PICTBRIDGE

Confirm the transfer-mode option in section 1 of the setup menu is set to PTP. Connect the camera to a PictBridge compatible printer using the camera's USB cable. The larger plug on the cable is connected to the printer. Slide the card-slot door toward the back of the camera to release the safety catch and open. Insert the smaller plug of the cable into the camera. Turn the camera on; the PictBridge screen is displayed automatically.

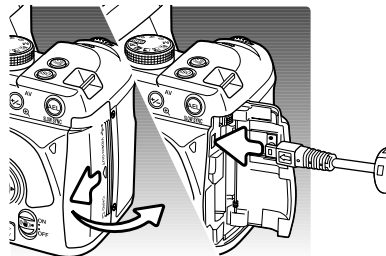

Individual still images can be selected for printing on the PictBridge screen; RAW and images with the embedded Adobe RGB color profile (p. 61) are not displayed and cannot be selected. Adobe RGB images without an embedded profile can be selected, but color reproduction may not be accurate because of printer compatibility with the color space. For other printing options, see the menu navigation section on page 128.

Use the left/right keys of the controller to display the image to be printed.



Press the up key to select the number of copies to be printed. To deselect an image for printing, press the down key until the number of copies reaches zero. A maximum number of fifty images can be printed.



Repeat the previous steps until all the images to be printed are selected. Press the central button of the controller to continue.



Total number of prints
Number of copies

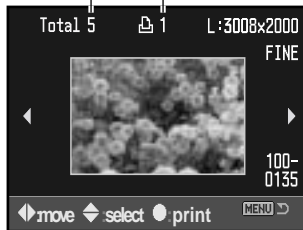

PictBridge screen

The display button switches between the single frame and index playback formats on the PictBridge screen. Enlarged playback, activated with the enlarge button (p. 38), can be used to examine image files on the screen.

The number of prints in the print run are displayed as well as the print parameters selected with the menu. See the menu navigation section for more information (p. 128). Press the central button of the controller to begin printing, or press the menu button to return to the PictBridge screen.

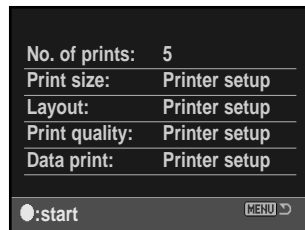

Once printing begins, the operation can be canceled by pressing the center of the controller. The printing-finished message indicates the end of the operation; turn the camera off to end the routine.

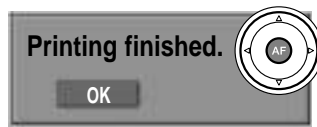

NOTES ON PRINTING ERRORS

If the battery is exhausted before the print run is complete, printing is canceled. Use a fully-charged battery or the optional AC adapter.

If a minor problem occurs during printing, such as the paper runs out, follow the procedure recommended for the printer; no action is required for the camera. If a major printer error occurs, press the center of the controller to end the routine. Refer to the printer manual for the correct procedure for the printer problem. Check the printer settings before starting again and deselect the images that were printed.

Printing Notes

Always confirm printer and camera settings before a print run to minimize errors. Setting print parameters with the PictBridge menu (p. 128) avoids having to set up the printer for each printing session, especially if the printer is used for multiple purposes.

NAVIGATING THE PICTBRIDGE MENU

Pressing the menu button opens and closes the menu. The four-way keys of the controller and the control dials move the cursor in the menu. Pressing the central button of the controller enters a setting. The options that can be changed vary with the printer.

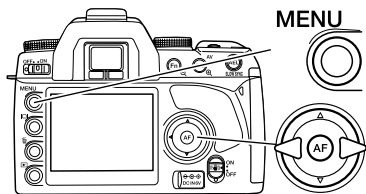

MENU

Activate the menu with the menu button. Tab 1 at the top of the menu is highlighted.

Use the left/right keys of the controller to highlight the appropriate menu tab; the menus change as the tabs are highlighted.



Use the up/down key to scroll through the menu options. Highlight the option whose setting needs to be changed.



With the menu option highlighted, press the right controller key; the settings are displayed with the current setting highlighted. If "Start" is displayed, press the center of the controller to continue.



Use the up/down key to highlight the new setting.



Press the central button of the controller to select the highlighted setting.

Once a setting has been selected, the cursor returns to the menu options and the new setting is displayed. To return to the PictBridge screen, press the menu button. Read the following sections on information on the menu options.

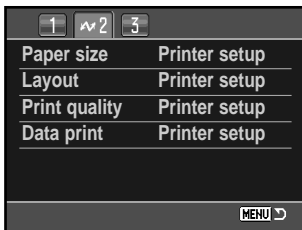

Index to menu functions

Batch print, 129
 Data print, 131
 DPOF print, 131

Index print, 129
 Layout, 130
 Paper size, 130

Print quality, 131

Batch print

Batch print in section 1 selects all still images on the memory card for printing. Two options are available:

All-frames - to print all images on the card. A screen opens so the number of copies of each image can be specified. A total number of fifty images can be printed.

Reset - to cancel changes made with the batch print option or with the print selection screen.

Index print

An index print of all still images on the memory card can be made. The quality and size of the print can be specified with the camera menu. The number of images per page varies with the printer. The print-setup confirmation screen is displayed before the print routine starts.

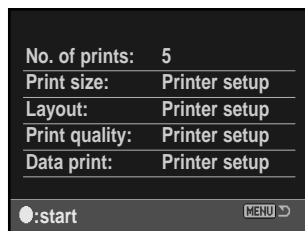

Paper size

The paper size of the print can be specified in section 2 of the PictBridge menu. The printer-setup option uses the size set with the printer.

Highlight the current size setting in the menu and press the central button of the controller to open the paper-size screen.

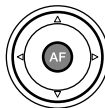

Use the four-way keys of the controller to highlight the paper size.



Press the central button of the controller to set the paper size.

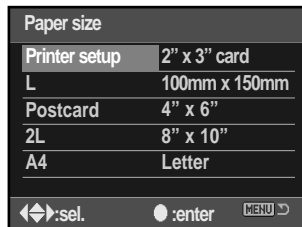
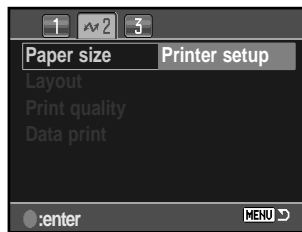
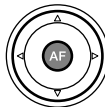

Printing Notes

The following are the dimensions for postcard, L, and 2L paper sizes in both millimeters and inches for your reference:

Postcard	100 X 148mm	3.9 X 5.9 in.
L	89 X 127mm	3.5 X 5.0 in.
2L	127 X 178mm	5.0 X 7.0 in.

Layout

The layout of the print can be set in section 2 of the PictBridge menu. The printer-setup option uses the layout parameters of the printer. Borderless printing can be specified with the camera as well as the number of images per page.

Print quality

The print quality can be set in section 2 of the PictBridge menu. The printer-setup option uses the quality set with the printer. The fine quality can be specified with the camera.

Data print

Data can be printed with the image in section 2 of the PictBridge menu. The printer-setup option uses the options set with the printer. The date of capture and the file name can be selected for printing. Data printing can also be disabled with the menu.

DPOF print

DPOF print in section 3 allows still images and an index print selected with the DPOF printing options in section 2 of the playback menu to be printed from a DPOF compatible PictBridge printer. Simply select the start option from the menu to begin the routine.

The number of prints in the print run are displayed; an index print is counted as one. Press the central button of the controller to begin printing, or press the menu button to return to the PictBridge menu.

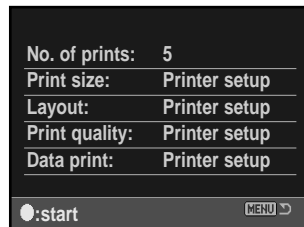

Once printing begins, the operation can be canceled by pressing the center of the controller. The printing-finished message indicates the end of the operation; press the center of the controller and turn the camera off to end the routine.

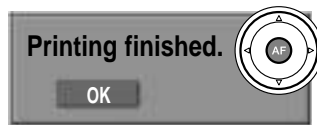

Kodak EasyShare software

The all-in-one digital photography software solution gives you an effortless way to organize, print, and share your pictures.

Organize your pictures

Kodak EasyShare software automatically organizes your pictures so you can find and view them quickly. Or create custom albums and sort pictures your own way.

Create beautiful prints

Turn your digital pictures into great prints with no hassles – at home, online, or from your local retailer.

Share precious memories

Share your favorite pictures with family and friends quickly and simply, right from the software.

Make the most out of your digital pictures

Make good pictures great with simple-to-use editing tools.

To take advantage of these features, install Kodak EasyShare software on your computer. Kodak EasyShare software is not supplied in all sales regions. The following are the system requirements for Kodak EasyShare software:

Windows 98, 98SE, Me, 2000 Professional with Service Pack 1 or later, XP Home or Professional.	Mac OS X 10.2.3 ~ 10.2.8 or Mac OS X 10.3 ~ 10.3.8.
Apple QuickTime 6	Safari 1.0 or later

If you are running Windows 2000 or Windows XP, you require administrator privileges to install Kodak EasyShare software. For service and support, visit Kodak at:

www.kodak.com/go/easysharesupportsw_english

IMPORTANT: Install the software from the Digital Camera Software CD-ROM before connecting the camera to the computer. Failure to do so may cause the software to install incorrectly.

1. Close all software applications that are open on your computer (including antivirus software).
2. Place the Digital Camera Software CD-ROM into the CD-ROM drive.
3. Install the software:
Windows OS-based computer – The launcher appears. Click the install Kodak EasyShare software button to begin the installation routine. If the install window does not appear, see software notes below.
Mac OS X – Double-click the CD icon on the desktop and open the Kodak EasyShare folder. Click the Install icon to begin the installation routine.
4. Follow the on-screen instructions to install the software.
Windows OS-based computer – On the setup-type screen, select Typical to automatically install all the applications. Select Custom to choose the applications you wish to install.
Mac OS X – Follow the on-screen instructions.
5. Restart the computer. If you turned off anti-virus software, turn it back on. See the anti-virus software manual for details.

For information on Kodak EasyShare software, click the Help button in the main window or use the Help drop-down menu.



Software Notes

If the Windows installer does not start up automatically, initiate the run routine on the start menu. Click the browse button in the run dialog box and select the CD-ROM drive from the look-in box in the browse window. Open the appropriate application and language folders to locate the Setup.exe file. Click on the Setup.exe file to display it in the run dialog box. Click OK.

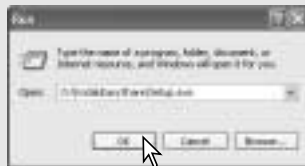

DiIMAGE Master Lite

DiIMAGE Master Lite is your entrance into digital imaging.

Image-processing tools

Color, contrast, saturation, and sharpness can be optimized to bring out the best in your images. Advanced RAW image processing for specific model DiIMAGE cameras ensures high-quality results.

Image information

Detailed information on how and when the image was recorded as well as file specifications can be viewed.

Picture editing

Download and sort your images quickly and efficiently on your computer. Collections of images can be displayed automatically as a slide show.

Color management

The use of monitor and printer ICC profiles allows accurate display and printing of images.

The following are the system requirements for DiIMAGE Master Lite software:

IBM PC/AT compatible computers	Apple Macintosh series computers
Pentium II processor or higher (Pentium III or higher recommended)	PowerPC G3 or higher (PowerPC G4 or higher recommended)
Windows 98, 98SE, Me, 2000 Professional, XP	Mac OS X: 10.1.3 ~ 10.1.5, 10.2.1 ~ 10.2.8, 10.3.0 ~ 10.3.9, 10.4 ~ 10.4.1
128MB of RAM (256MB or more recommended)	
200MB or more of hard-disk space (100MB or more for installation)	
A 16-bit color monitor with a minimum resolution of 1024 X 768 (XGA) or higher.	
QuickTime 6 or later	

If you are running Windows 2000 or XP, you require administrator privileges to install DiIMAGE Master Lite. Compatibility with Windows XP is with the Home or Professional editions. Computers with Windows 98 operating systems require Microsoft Internet Explorer 5.0 or later.

For a complete description of DiMAGE Master Lite, refer to the pdf manual on the supplied DiMAGE Instruction Manual CD-ROM. The manual is located in the manual folder on the CD-ROM and organized in language folders. Copy the file to your computer for reference.

Adobe Reader is required to open the pdf manual. A copy of this software is included on the DiMAGE Instruction Manual CD-ROM and organized in language folders. Double click on the installer icon and follow the instructions on the installer screens to install the software. The latest version of Adobe Reader can be downloaded at www.adobe.com.

1. Close all software applications that are open on your computer including antivirus software.
2. Place the Digital Camera Software CD-ROM into the CD-ROM drive.
3. Install the software:
 - Windows based computer** – The launcher appears. Click the camera support Applications button and then the install DiMAGE Master Lite button to begin the installation routine. If the launcher does not appear, see software notes on page 133.
 - Mac OS X** – Double-click the CD icon on the desktop, open the Utility folder, the DiMAGE Master Lite folder, and then the appropriate language folder. Click the Installer icon to begin the installation routine.
4. Follow the on-screen instructions to install the software. Refer to the Master Lite pdf instruction manual for detailed installation and operation instructions.
5. If you turned off anti-virus software, turn it back on. See the anti-virus software manual for details.

The full version of DiMAGE Master gives you all the tools to organize, examine, and process your images as well as sophisticated tools for RAW processing. For more on DiMAGE Master, see page 81 or visit us on the web at:

North America: <http://kmpi.konicaminolta.us/>
Europe: <http://www.konicaminoltasupport.com>

TROUBLESHOOTING

The section covers minor problems with basic camera operation. For major problems or damage to the camera or charger, or if a problem continues to reoccur frequently, contact a Konica Minolta service facility.

Problem	Symptom	Cause	Solution
The camera will not work.	Nothing displayed on monitor.	The battery is dead.	Recharge battery (p. 20).
		The AC adapter is not connected properly.	Check that the adapter is connected to the camera and a live electrical outlet (p. 22).
		Display mode set to off.	Change the display mode to full or basic (p. 33).
	Camera overheating message is displayed before shutting down.	The camera is hot or it has been left in a very hot environment.	Turn off the camera and allow it to cool.
Shutter will not release.	“0000” is displayed on the frame counter.	Memory card is full and unable to store an image at the image-quality or image-size setting on the camera.	Insert a new memory card (p. 24), delete some images (p. 36), or change the image-quality or image-size setting (p. 70).
	“----” is displayed on the frame counter.	No memory card in the camera.	Insert a memory card (p. 24).

Problem	Symptom	Cause	Solution
Pictures are not sharp.	Focus signal is blinking.	Subject is too close.	Make sure the subject is within the focus range of the lens.
		A special situation is preventing the autofocus system from focusing (p. 29)	Use the focus-lock function to focus on an object at the same distance as the subject (p. 30) or use manual focus (p. 49).
	Pictures are taken indoors or in low-light situations without flash.	Slow shutter speeds result in blurred images when the camera is hand-held.	Use Anti-shake or a tripod, change the camera sensitivity to a higher setting (p. 54), or use the flash (p. 31).
While using flash, the pictures are too dark.	The subject is beyond the flash range (p. 55).		Move closer to the subject or change the camera sensitivity to a higher setting (p. 54).
A shadow appears on the bottom of the image.	Lens hood mounted when using flash.	The lens hood blocks the light from the built-in flash.	Always remove the lens hood when using the built-in flash. Also see the lens shadowing section on page 110.

Problem	Symptom	Cause	Solution
Inaccurate exposures with very bright or dark scenes.	Shutter speed and/or aperture display blink.	Subject or scene is outside the exposure control range of the camera.	Adjust the exposure until the display stops blinking or change camera sensitivity (p. 54).
	Arrows blink at each end of the Ev scale.	Subject or scene is outside the metering range of the camera.	In dark conditions, use the camera flash. Under bright light, use a neutral density filter on the lens to control the light levels.
Anti-Shake does not work.	The viewfinder Anti-Shake scale is blinking.	CCD setup error.	Turn the camera off and on. If the Anti-Shake scale continues to blink, contact a Konica Minolta service facility.
Unable to see recorded images in playback.	Folder number not displayed.	Folder is not selected with the view-folder option in section 1 of the playback menu.	Select the folder with the menu (p. 82).
Unable to delete folders with the file browser (p. 87).		Memory card was opened on a Windows operating system.	Delete the folder using the computer.

If the camera does not function normally, turn it off, remove and reinsert the battery, or unplug and reconnect the AC adapter. Always turn the camera off using the main switch otherwise the memory card may be damaged and camera settings reset.

CARE AND STORAGE

Read this section in its entirety to get the best results from your camera. With proper care, your camera will provide years of service.

CAMERA CARE

- Do not subject the camera to shock or impact.
- Turn off the camera when transporting.
- This camera is neither waterproof nor splashproof. Inserting or removing batteries or the memory card, or operating the camera with wet hands may damage the camera.
- When at the beach or near water, take care not to expose the camera to water or sand. Water, sand, dust, or salt can damage the camera.
- Do not leave the camera under direct sunlight. Do not point the lens directly at the sun; the CCD may be damaged.
- Keep the camera away from electromagnetic fields from devices such as magnets or motors.

CLEANING

- If the camera or the outside of the lens is dirty, gently wipe it with a soft, clean, dry cloth. If the camera or lens comes in contact with sand, gently blow away loose particles. Wiping may scratch the surface.
- To clean the lens surface, first blow away any dust or sand, then gently wipe the lens with a cloth or tissue designed for optics. Use lens-cleaning fluid if necessary.
- Never use organic solvents to clean the camera.
- Never touch the lens surface with your fingers.

STORAGE

- Store in a cool, dry, well-ventilated area away from dust and chemicals. For long periods of disuse, store the camera in an airtight container with a silica-gel drying agent.
- Remove the batteries and memory card from the camera when not in use for extended periods.
- Do not store the camera in an area with naphthalene or mothballs.
- During long periods of storage, operate the camera occasionally. When taking the camera out of storage, check that the camera is functioning properly before using.

OPERATING TEMPERATURES AND CONDITIONS

- This camera has been designed for use in temperatures from 0°C to 40°C (32°F to 104°F).
- Never leave the camera exposed to extreme high temperatures, such as in a car parked in the sun, or to extreme humidity.
- When taking the camera from a cold to a warm environment, place it in a sealed plastic bag to prevent condensation from forming. Allow the camera to come to room temperature before removing it from the bag.

MEMORY CARD CARE AND HANDLING

Memory Cards are manufactured with precision electronic components. Konica Minolta has no responsibility for any loss or damage to data. It is recommended that a copy of the card data be made. The following may cause data loss or damage:

- Improper use of the card.
- Bending, dropping, or subjecting the card to impact.
- Heat, moisture, and direct sunlight.
- Static electrical discharge or electromagnetic fields near the card.
- Removing the card or interrupting the power supply while the camera or a computer is accessing the card (reading, writing, formatting, etc.).
- Touching the electrical contacts of the card with your fingers or metal objects.
- Using the card beyond its life. Purchasing a new card periodically may be necessary.
- When using a Microdrive, do not subject the camera to vibrations.

BATTERIES

- Battery performance decreases with temperature. In cold environments, we recommend keeping spare batteries in a warm place, such as the inside of a coat. Batteries can recover their power when they warm up.
- Do not store the battery when it is fully charged.
- When storing the battery for extended periods, recharge it for five minutes every six months. The battery may not be able to be charged if completely exhausted.
- A special built-in battery supplies power to the clock and memory when the camera is exhausted or removed. If the camera resets each time the battery is removed, the battery is exhausted. It must be replaced at a Konica Minolta service facility.

- After initially inserting the battery, do not remove it for twelve hours; the camera can be off during this period. The main battery is used to charge an internal battery, which protects settings when the main battery is removed.
- Keep battery and camera charger contacts clean. Dirty contacts can prevent charging. If the contacts become dirty, wipe them with a cotton swab.

LCD MONITOR CARE

- The LCD monitor is manufactured using high-precision technology and more than 99.99% of the pixels operate properly. Less than 0.01% of the monitor pixels are displayed as color or bright points; this is not monitor defect and does not affect the recorded image.
- Do not apply pressure to the surface of the LCD monitor; it may be permanently damaged.
- In a cold environment, the LCD monitor may become temporarily dark. When the camera warms up, the display will function normally.
- If fingerprints are on the LCD monitor surface, gently wipe with a soft, clean, dry cloth.

COPYRIGHT

- TV program, films, video tapes, photographs, and other materials may be copyrighted. Unauthorized recording or duplication of such material may be contrary to copyright laws. Taking pictures or images of performances, exhibitions, etc. is prohibited without approval and can infringe on copyright. Images protected by copyright can only be used under the provisions within the copyright laws.

BEFORE IMPORTANT EVENTS OR JOURNEYS

- Check the camera's operation; take test pictures and purchase spare batteries.
- Konica Minolta has no responsibility for any damage or loss incurred by equipment malfunction.

QUESTIONS AND SERVICE

- If you have questions about your camera or charger, contact your local camera dealer or write to the Konica Minolta distributor in your area.
- Before shipping your camera or charger for repair, please contact a Konica Minolta service facility.

The following marks may be found on the product:



This mark on your camera certifies that this camera meets the requirements of the EU (European Union) concerning interference causing equipment regulations. CE stands for *Conformité Européenne* (European Conformity).

FCC Compliance Statement
Declaration on Conformity

Responsible Party: Konica Minolta Photo Imaging U.S.A. Inc.
Address: 725 Darlington Avenue, Mahwah, NJ 07430

Digital Camera: Maxxum 5D



Tested To Comply
With FCC Standards

FOR HOME OR OFFICE USE

This device complies with Part 15 of the FCC Rules. Operation is subject to the following two conditions: (1) This device may not cause harmful interference, and (2) this device must accept any interference received, including interference that may cause undesired operation. Changes or modifications not approved by the party responsible for compliance could void the user's authority to operate the equipment. This equipment has been tested and found to comply with the limits for a Class B digital device, pursuant to Part 15 of the FCC Rules. These limits are designed to provide reasonable protection against harmful interference in a residential installation.

This equipment generates, uses and can radiate radio frequency energy and, if not installed and used in accordance with the instructions, may cause harmful interference to radio communications. However, there is no guarantee that interference will not occur in a particular installation. If this equipment does cause harmful interference to radio or television reception, which can be determined by turning the equipment off and on, the user is encouraged to try to correct the interference by one or more of the following measures:

- Reorient or relocate the receiving antenna.
- Increase the separation between the equipment and the receiver.
- Connect the equipment to an outlet on a circuit different from that to which the receiver is connected.
- Consult the dealer or an experienced radio/TV technician for help.

Do not remove the ferrite cores from the cables.

This Class B digital apparatus complies with Canadian ICES-003.



For EU member states only

This symbol means: Do not dispose of this product together with your household waste.

Please refer to the information of your local community or contact our dealers regarding the proper handling of end-of-life electric and electronic equipment.

Recycling of this product will help to conserve natural resources and prevent potential negative consequences for the environment and human health caused by inappropriate waste handling.



TECHNICAL SPECIFICATIONS

Number of effective pixels:	6.1 million
CCD:	APS-C size (23.5 X 15.7mm) interline primary-color CCD with a total of 6.3 million pixels
Camera sensitivity (ISO):	Auto, 100, 200, 400, 800, 1600, 3200 ISO equivalents
Aspect ratio:	3:2
A/D conversion:	12 bit
Autofocusing system:	TTL phase-detection system with CCD line sensor.
AF sensitivity range:	Ev -1 ~ +18 (at ISO 100)
Meter:	14-segment honeycomb-pattern SPC
Metering range:	Ev \pm 1 ~ +20 (Spot: Ev +4 ~ +20) at ISO 100, <i>f</i> /1.4.
Shutter:	Electronically-controlled, vertical-traverse, focal-plane shutter
Flash guide number:	12 (in meters at ISO 100)
Flash sync.:	1/125s with Anti-Shake, 1/160s without Anti-Shake
Flash coverage:	Equal to a 18mm focal-length lens
Built-in flash recycling time:	3s (approx.)
Viewfinder:	Eye-level fixed roof mirror.
Field of view:	95% (approx.)
Eye relief:	Approximately 20mm from the eyepiece or 16mm from the eyepiece cup at -1 diopter.
Viewfinder magnification:	0.83x (50mm lens at infinity at -1 diopter).
Monitor LCD:	2.5 inch TFT color low-temperature polysilicon
Recording media:	Type I and II CompactFlash cards, Microdrives.
File formats:	JPEG and RAW. DCF 2.0, DPOF, and Exif 2.21 compliant.
PRINT Image Matching III:	Yes
Menu languages:	English, German, French, Spanish, Japanese, Italian, Swedish, Russian, Korean, and Chinese (simplified and traditional).
Video output:	NTSC and PAL

Battery:	One Lithium-ion Battery NP-400
Optional power source:	AC adapter (AC-11)
Battery performance (recording):	Approx. number of recorded images: 550 frames. Based on the CIPA standard with a NP-400 lithium-ion battery, 512MB CompactFlash card.
Dimensions:	130.5 (W) X 92.5 (H) X 66.5 (D) mm 5.14 (W) X 3.64 (H) X 2.62 (D) in
Weight:	Approximately 590g (21 oz) (without battery, memory card, or body accessories)
Operating temperature:	0° - 40°C (32° - 104°F)

Lithium-ion Battery Charger BC-400

Input voltage:	AC 100-240V, 50-60Hz
Weight:	86g (3.0 oz.)
Dimensions:	65 (W) X 90 (H) X 30 (D) mm 2.56 (W) X 3.54 (H) X 1.18 (D) in

Lithium-ion Battery NP-400

Voltage:	7.4V, 1500mAh
Weight:	85g (3.0 oz.)
Dimensions:	56.0 (W) X 39.5 (H) X 21.0 (D) mm 2.20 (W) X 1.56 (H) X 0.83 (D) in

Specifications are based on the latest information available at the time of printing and are subject to change without notice.

INDEX

Access lamp, 22, 24, 122, 124

Accessories

AC adapter, 22

Flash, 79, 112, 113

Remote cord, 111

Viewfinder, 59

ADI metering, 79

Adobe RGB, 62, 88, 120, 126

AF areas, 17, 56, 57

AE lock button, 46, 94

AF illuminator, 96

AF / MF switch, 49

AF modes, 56, 58

AF / Shutter release priority, 93

Audio signals, 102

Autofocus, 48, 57, 58,

Special focusing situations, 29

Spot AF, 47

Auto recording, 27, 41

Anti-Shake, 32, 110

Aperture, 55

Aperture priority, 42

Auto power save, 23, 105, 119

Battery

Care and storage, 140

Changing, 21

Charging, 20, 113

Condition, 23

Bracketing, 50, 80

Exposure, 52

White balance, 53

Bulb exposures, 45

Camera sensitivity, 54, 55

Camera shake, 30, 32

CCD cleaning, 106

Color mode, 56, 61

Color temperature, 64, 67, 69

Continuous-advance drive mode, 50, 51

Contrast, 56, 63

Control-dial setup, 95

Date and time, 26, 103

Delete, 36, 80, 84, 87

Depth-of-field preview, 49, 94

Digital Effects Control, 56, 63

DiMAGE Master, 62, 81, 106

DiMAGE Master Lite, 62, 132

Diopter adjustment, 19

Direct manual focus (DMF), 56, 58

Display

Backlight, 105

Brightness, 100

Enlarged, 38

Histogram, 35

Luminance limit, 35

Playback, 34, 37, 87, 97

Recording, 16, 27, 33, 97

Setup, 97

TV, 101

Viewfinder, 17

DPOF, 88 - 90, 131

Drive modes, 50

Exposure compensation, 48, 95

Exposure lock, 46

Exposure modes, 39 - 45

Eyepiece cap, 111

File browser, 37, 87

File number memory, 103, 121

Fill flash, 75

Flash, 31

Attaching, 112

Compatibility, 112

Compensation, 56, 60

Control, 79

Modes, 75

Range, 31, 55

Sync. speed, 42, 112

- f*-number, 55
- Focus-area selection, 57
- Focus-hold button, 94
- Focus lock, 30
- Focus signal, 27, 28, 29
- Folder
 - Delete, 87
 - Organization, 120
 - Name, 85, 104
 - New, 105
 - Select, 104
 - View, 85
- Formatting, 25, 85
- Frame counter, 16, 73
- Frame-selection screen, 83
- Frames-remaining counter, 17
- High speed sync. (HSS), 112
- Image size, 72
- Image quality, 72
- Index playback format, 37, 87
- Instant Playback, 28, 74
- ISO, 54, 55
- Kodak EasyShare, 132
- Lens
 - Attach, 18
 - Compatibility, 110
 - Focal-length conversion, 110
 - Remove, 18
 - Shadowing, 110
- Lock, 86
- Luminance limit, 35
- Manual exposure, 44
- Manual focus, 49
- Memory card, 24, 140
- Menu
 - Custom, 91, 92
 - Language, 102
 - Playback, 82
 - Recording, 70
 - Section memory, 106
 - Setup, 91, 98
- Noise reduction, 74
- PictBridge, 128
 - Printing errors, 127
 - Menu, 128
- Pre-flash TTL metering, 79
- Program, 27, 41
- Program shift, 41
- RAW, 62, 72, 120, 128
- Rear flash sync., 75
- Red-eye reduction, 75
- Remote cord, 111
- Remote flash, see wireless flash
- Reset, 41, 80, 108
- Rotate, 34, 97
- Saturation, 63
- Self timer, 50, 51
- Sharpness, 63
- Shutter lock, 96
- Shutter priority, 42
- Shutter speeds, 43
- Slide show, 88
- Slow sync., 47
- Transfer mode, 100, 115
- Troubleshooting, 136
- USB
 - Connection, 115
 - Disconnection, 122 - 124
 - System requirements, 114
 - Windows 98 driver installation, 116
- Video output, 101
- White balance, 64
- Wireless flash, 71 - 73
- Zone matching, 54



KONICA MINOLTA

KONICA MINOLTA PHOTO IMAGING, INC.

© 2005 Konica Minolta Photo Imaging, Inc. under the Berne Convention
and the Universal Copyright Convention.



9222-2186-11 MY-A506
Printed in Malaysia