

# SOFTWARE INSTALLATION AND PC CONNECTION GUIDE

LYT0873-001A

COPYRIGHT © 2001 VICTOR COMPANY OF JAPAN, LTD.

M2D2 NON DSC

Printed in Japan  
1101 HOV\*ID\*YP

## JVC SOFTWARE LICENSE AGREEMENT

### IMPORTANT

**TO CUSTOMERS:****MAKE SURE TO READ THIS CAREFULLY BEFORE OPENING THE SEALED  
SOFTWARE PACKETS**

Thank you for purchasing our product. In order to start using the software program enclosed, you are required to accept the terms and conditions of the agreement as provided below.

## Software License Agreement

This is a legal agreement between you (either an individual or an entity) and Victor Company of Japan, Limited (JVC). By opening the sealed software packages and/or by using the Program, you are agreeing to be bound by the terms of this Agreement. Should you not agree to the terms hereof, return the unopened software packets and the accompanying items to the place where you obtained them.

### 1 GRANT OF LICENSE

This License Agreement (Agreement) permits you to use the software program (Program) enclosed in this package and/or the accompanying written material (e. g. printed manuals). Although you are also granted license to load the Program into temporary memory (i. e. RAM) or install the Program once into permanent memory (e. g. hard disk, CD-R, or other storage device) of one (1) computer system, you are strictly prohibited to install the Program on a network server for the sole purpose of internal distribution.

### 2 COPYRIGHT

Notwithstanding the provision of Article 1 hereof, any copyright in the Program is owned exclusively by JVC and is protected by the Japanese copyright law, copyright laws of other countries, as applicable, and relevant provisions under international treaties including the Berne Convention for the Protection of Literary and Artistic Works, as amended, and the Universal Copyright Convention, as amended. Therefore, you must treat the Program like any other copyrighted material except that you may either (a) make one (1) copy of the Program solely for your personal backup or archival purposes, or (b) transfer the Program to a single hard disk, provided that you keep the original solely for your personal backup or archival purposes.

### 3 RESTRICTION ON THE PROGRAM

You may not reverse engineer, decompile, disassemble, revise or modify the Program, except to the extent that such restriction is expressly prohibited by applicable law. JVC and its distributors and dealers shall not be liable for any claims or defects etc. arising out of or in connection with such prohibited activities as indicated in this Agreement.

### 4 OTHER RESTRICTIONS

You may not rent, lease or transfer the Program to any third party nor let such a party use the Program.

## 5 LIMITED WARRANTY

JVC warrants that any media in which the Program is embodied (e.g. floppy discs, CD-ROM, etc.) are free from any defects in materials and workmanship for a period of thirty (30) days from the date of your purchase and that any hardware accompanying the Program is also free from defects to the extent provided in the attached Warranty Form. JVC's entire liability and your exclusive remedy in connection with the Program shall be, at JVC's option, either (a) return of the price paid, or (b) replacement of defective Program media.

## 6 DISCLAIMER OF WARRANTIES

EXCEPT FOR THE EXPRESS WARRANTIES STATED HEREIN AND TO THE EXTENT PERMITTED BY APPLICABLE LAW, JVC AND ITS SUPPLIERS DISCLAIM ANY OTHER WARRANTIES, EITHER EXPRESS OR IMPLIED, INCLUDING BUT NOT LIMITED TO IMPLIED WARRANTIES OF MERCHANTABILITY AND FITNESS FOR A PARTICULAR PURPOSE IN REGARD TO THE PROGRAM AND THE ACCOMPANYING PRINTED MATERIALS.

## 7 LIMITED LIABILITY

TO THE EXTENT PERMITTED BY APPLICABLE LAW, IN NO EVENT SHALL JVC AND ITS SUPPLIERS BE LIABLE FOR ANY INDIRECT, SPECIAL, INCIDENTAL OR CONSEQUENTIAL DAMAGES WHATSOEVER, REGARDLESS OF THE FORM OF ACTION WHETHER IN CONTRACT, TORT, STRICT PRODUCT LIABILITY OR OTHERWISE (INCLUDING BUT NOT LIMITED TO DAMAGES FOR LOSS OF PROFITS, BUSINESS INTERRUPTION, LOSS OF BUSINESS INFORMATION OR ANY OTHER PECUNIARY LOSS) ARISING OUT OF OR IN CONNECTION WITH THE USE OF OR INABILITY TO USE THE PROGRAM, EVEN IF JVC HAS BEEN ADVISED OF THE POSSIBILITY OF SUCH DAMAGES.

Victor Company of Japan, Limited

### **CAUTION:**

- Operate this equipment according to the operating procedures described in this manual.
- Use only the provided CD-ROM. Never use any other CD-ROM to run this software.
- Do not attempt to modify this software.
- Changes or modifications not approved by JVC could void user's authority to operate the equipment.

### **How to handle a CD-ROM**

- Take care not to soil or scratch the mirror surface (opposite to the printed surface). Do not write anything or put a sticker on either the front or back surface. If the CD-ROM gets dirty, gently wipe it with a soft cloth outward from the center hole using a circular motion.
- Do not use conventional disc cleaners or cleaning spray.
- Do not bend the CD-ROM or touch its mirror surface.
- Do not store your CD-ROM in a dusty, hot or humid environment. Keep it away from direct sunlight.

- You can find the latest information (in English) on the provided software program at our world wide web server at <http://www.jvc-victor.co.jp/english/index-e.html>

# OPERATING ENVIRONMENT

A camcorder can be connected to a PC that satisfies the following requirements.

## Windows®

<b>OS</b>	: Windows® 98 (pre-installed), Windows® 98 Second Edition (98SE) (pre-installed), Windows® Millennium Edition (Me) (pre-installed), or Windows® 2000 Professional (pre-installed)
<b>CPU</b>	: Intel MMX® Pentium®, at least 200 MHz
<b>RAM</b>	: At least 64 MB recommended
<b>Free hard disk space</b>	: At least 10 MB for installation, at least 500 MB recommended
<b>Connectors</b>	: 1 free serial transmission port, compatible with 9600 bps or higher transmission rate, connectable to RS-232C with 9 pin serial connector (Recommended compatible with UART 16550A)
<b>Display</b>	: Must be capable of displaying 800 x 600 dots with 16-bit color

### **NOTE:**

An optional 9 pin serial conversion adapter is required for computers using a serial communication port other than a standard 9 pin.

## Macintosh

<b>Hardware</b>	: iMac, iBook, Power MacintoshG3, Power MacG4, Power BookG3 or G4 equipped with a USB connector
<b>OS</b>	: Mac OS 8.6 to 9.1 (exclude Mac OS X)
<b>RAM</b>	: At least 64 MB recommended
<b>Free hard disk space</b>	: At least 2 MB for installation, at least 40 MB recommended
<b>Miscellaneous</b>	: QuickTime 4 or later

- The system requirements information above is not a guarantee that the provided software will work on all personal computers meeting those requirements.
- Microsoft® and Windows® are either registered trademarks or trademarks of Microsoft Corporation in the United States and/or other countries.
- Macintosh is a registered trademark of Apple Computer, Inc.
- Keyspan is a trademark of InnoSys Inc.
- Other product and company names included in this instruction manual are trademarks and/or registered trademarks of their respective holders.

## NOTICE FOR USERS

Use of this software is authorized according to the terms of the software license.

When contacting the nearest JVC office or agency in your country about this software (refer to the JVC Worldwide Service Network at <http://www.jvc-victor.co.jp/english/worldmap/index-e.html>), please fill out the following and have the appropriate information ready.

Product Name		
Model		
Problem		
Error Message		
PC	Manufacturer	
	Model	<input type="checkbox"/> Desktop <input type="checkbox"/> Laptop
	CPU	
	OS	
	Memory	MB
	Available Hard Disk Space	MB

Please note that it may take some time to respond to your questions, depending on their subject matter.

**JVC cannot answer questions regarding basic operation of your PC, or questions regarding specifications or performance of the OS, other applications or drivers.**

## Create a virtual album

If you have a lot of image files with similar names, it can be hard to remember which file contains which image.

You can use this software to display these images on your PC just as if you had pasted them in a photo album. Because you can scan through these images just as if you were flipping through a photo album, you can quickly find a specific image that you want to send through e-mail, for example.

### Can I distribute copies of albums?

You can save albums in web page format. When the album is saved in this format, anyone with a browser can view the album on any type of PC. Because the album is already in web page format, you can also exhibit your photos on the Internet.

Under copyright law, it is illegal to distribute copyrighted images without the permission of the copyright holder. Make sure that you have permission to distribute such images before actually doing so.

## Send your favorite images by e-mail

Everyone has video cassettes containing videos and snapshots that they never get to show to anyone.

No matter how wonderful, the only people that got to see them were families and guests, because there was no convenient way to show them except in your own home on the TV. Friends and relatives who live far away had no way of viewing them. And you don't want to give those video cassettes away because they hold treasured memories.

Now you can solve all of these problems with a PC. By using a PC connection cable to connect a camcorder to a PC, you can capture image from the camcorder to the PC. You can then send the files to anyone as an e-mail attachment.

## Capture still images

Video images from a camcorder can be captured as still images.

You can capture still images from a recorded tape.

## CONNECTIONS (Windows®)

Connect the PC connection cable to use Digital Photo Navigator.

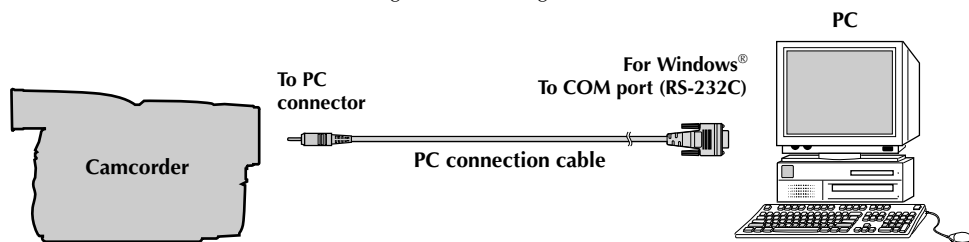

- 1 To assure safety, make sure all units are turned off before making any connections.
- 2 Use a PC connection cable to connect the camcorder to the PC.
  - We recommend that you use the AC Adapter.

**NOTE:**

*When disconnecting the PC connection cable, be sure to turn off the camcorder and the PC.*

# SOFTWARE INSTALLATION (Windows®)

Follow the procedure described below to install the software.

Quit any other software you are using. (Check that there are no other application icons on the task bar.)

**1** Load the provided CD-ROM in the PC.

After a moment, the [Setup] screen appears.

- If the [Setup] screen does not appear, double-click [My Computer] and then double-click the CD-ROM icon.

From the [Setup] screen, you can install the following softwares.

## Digital Photo Navigator 1.0

This application is used to capture still images and convert them into a variety of formats.

## NewSoft Presto! Mr. Photo 3/ImageFolio

This application is used to store and catalogue images or create electronic album. You can also process captured images in detail on PC.

## Adobe® Acrobat® Reader 5.0

This application is used to read PDF files.

**2** Click [Install] on the right side of the desired software.

(The following is the example of Digital Photo Navigator.)

[License Agreement] screen appears.

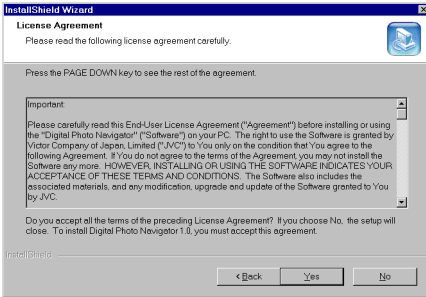

Click [Yes].

Then, [Choose Destination Location] screen appears.

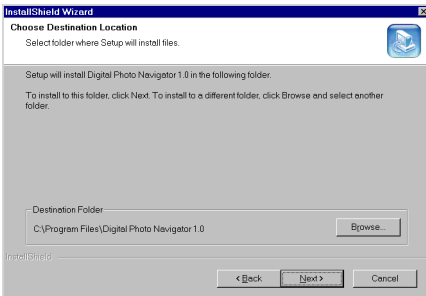

Click [Next].

Next, [Select Program Folder] screen appears.

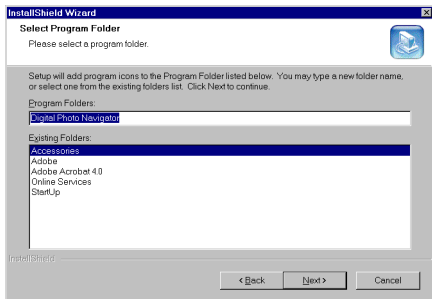

Click [Next].

[Setup Status] screen appears. Wait for a moment until the installation is finished.

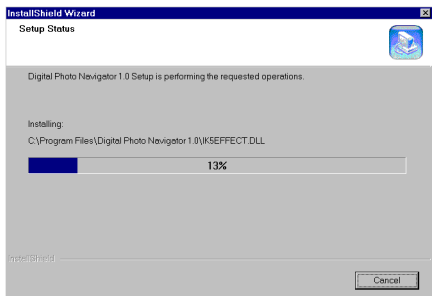

When the installation is finished, [Digital Photo Navigator Setup] screen appears and asks you if you want to create the icon on the desktop.

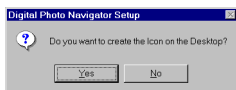

If you need it, click [Yes]. If not, click [No].

**3** When the message asking whether it is OK to restart the PC appears, click [Yes]. The PC restarts, and after a moment the [Setup] screen from step 1 appears.

**4** Repeat steps 2 and 3 to install all of the desired software.

## NOTES:

- The Digital Photo Navigator instruction manual is also included on the CD-ROM in PDF format. Double-click the [JVC] folder and then double-click the [Docs] folder. Open the "Start.pdf" file and click the button of the desired language. Note that Adobe® Acrobat® Reader must be installed to read PDF files.
- If you install the Korean version of NewSoft Presto! Series, Acrobat® Reader for Korean is necessary to read the PDF files. Install Acrobat® Reader for Korean included in the [Reader K] folder inside the [NewSoft] folder of the provided CD-ROM.
- If you install the simplified Chinese version of NewSoft Presto! Series, Acrobat® Reader for simplified Chinese is necessary to read the PDF files. Install Acrobat® Reader for simplified Chinese included in the [Reader CS] folder inside the [NewSoft] folder of the provided CD-ROM.
- If you perform installation of a software that is already installed, uninstallation will start. In this case, perform the installation again after uninstallation is finished.



## Digital Photo Navigator FACILITY (Macintosh)

Video images from a camcorder can be captured as still images.

## CONNECTIONS (Macintosh)

Connect the PC connection cable with the optional USB PDA ADAPTER to use Digital Photo Navigator. USB PDA ADAPTER USA-19 (by KEYSpan) is necessary to connect a camcorder to the Macintosh.

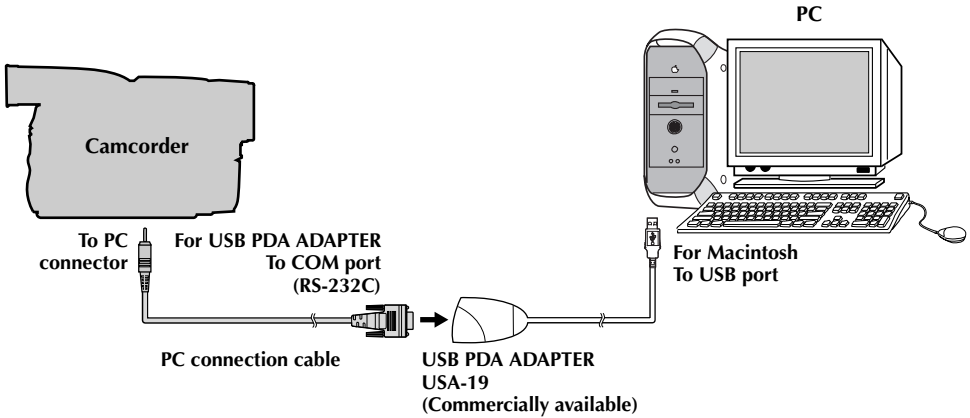

- 1 To assure safety, make sure all units are turned off before making any connections.
- 2 Use the PC connection cable and the USB PDA ADAPTER to connect the camcorder to the PC.
  - We recommend that you use the AC Adapter.
- 3 Install the USB PDA ADAPTER driver.
  - For details, refer to the instructions of USB PDA ADAPTER.

### NOTE:

When disconnecting the PC connection cable, be sure to turn off the camcorder and the PC.

## SOFTWARE INSTALLATION (Macintosh)

Follow the procedure described below to install the software.  
Quit any other software you are using.

**1** Load the provided CD-ROM into the PC. Double click the CD-ROM icon.

- The provided CD-ROM includes 3 folders.  
[JVC]: Includes the Digital Photo Navigator folder.  
[NewSoft]: Includes the Installer for Presto! Series.  
[Reader]: Includes the Installer for Acrobat® Reader.

**2** Drag the desired software folder from the CD-ROM to the hard disk.

- Do not drag the folder to the System folder.
- Install the driver for USB PDA ADAPTER USA-19 before you start up Digital Photo Navigator. For details, refer to the instruction manual of USB PDA ADAPTER.

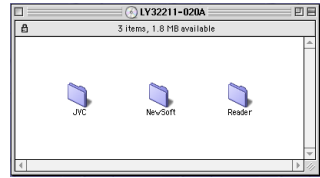

### NOTES:

- The Digital Photo Navigator instruction manual is also included on the CD-ROM in PDF format. Double-click the [JVC] folder and then double-click the [Docs] folder. Open the "Start.pdf" file and click the button of the desired language. Note that Adobe® Acrobat® Reader must be installed to read PDF files.
- If you install the Korean version of NewSoft Presto! Series, Acrobat® Reader for Korean is necessary to read the PDF files. Install Acrobat® Reader for Korean included in the [Reader K] folder inside the [NewSoft] folder of the provided CD-ROM.
- If you install the simplified Chinese version of NewSoft Presto! Series, Acrobat® Reader for simplified Chinese is necessary to read the PDF files. Install Acrobat® Reader for simplified Chinese included in the [Reader CS] folder inside the [NewSoft] folder of the provided CD-ROM.

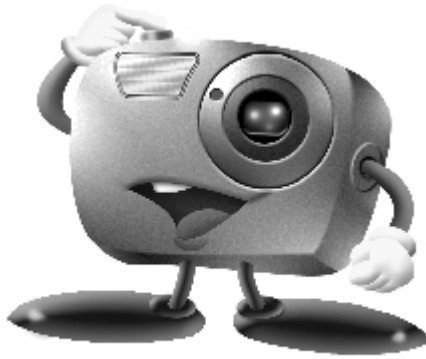

## **Mr. Photo Gold**

### **For Windows:**

**Presto! Mr. Photo 3**

**Presto! ImageFolio**

### **For Macintosh:**

**Presto! Mr. Photo**

**Presto! PhotoAlbum**

### **Copyright and Trademarks**

©1998-2001, NewSoft Technology Corp. All Rights Reserved.

No portion of this document may be copied or reproduced in any manner without prior written permission from NewSoft Technology Corp. (NewSoft).

NewSoft has no warranties to this documentation and disclaims any implied warranty of merchantability or fitness for a particular purpose. All the information contained herein is subject to change without notice.

All sample images and electronic files included in the documentation and distribution materials are copyrighted by their respective photographers and not allowed to be copied or reproduced in any manner. All other product names and any registered and unregistered trademarks mentioned in this manual are used for identification purposes only and remain the exclusive property of their respective owners.

# TECHNICAL SUPPORT

- USA:** **NewSoft America, Inc.**  
4113 Clipper Court, Fremont, CA 94538, U.S.A  
Tel: 1-510-445-8616  
Fax: 1-510-445-8601  
E-mail of sale issue: sales@newsoftinc.com  
Web-based tech support: www.newsoftinc.com/faq.cfm  
NewSoft America Inc. Web site: http://www.newsoftinc.com
- Taiwan:** **NewSoft Technology Corp.**  
3F NO. 19-3, Sanchong RD., Nankang, Taipei, Taiwan  
Tel: 886-2-26551201  
Fax: 886-2-26551100  
E-mail of sale issue: sales@newsoft.com.tw  
E-mail of tech support issue: support@newsoft.com.tw  
NewSoft Technology Corp. Web site: http://www.newsoft.com.tw
- Japan:** **NewSoft Japan Corp.**  
6-21-3 Shinbashi, Minato-Ku, Tokyo 105-0004, Japan  
Tel: 81-3-5472-7008  
Fax: 81-3-5472-7009  
E-mail of sale issue: support@newsoft.co.jp  
E-mail of tech support issue: support@newsoft.co.jp  
NewSoft Japan Corp. Web site: http://www.newsoft.co.jp
- Europe:**
- |                        |   |
|------------------------|---|
| <b>England</b>         | <b>The Software Centre</b><br>East Way, Lee Mill Industrial Estate, Ivybridge, Devon, PL21 9PE,<br>UK<br>Tel: (44)01752-201148<br>Fax: (44)01752-894833<br>E-mail: Tech@guildsoft.co.uk   |
| <b>German</b>          | <b>MitCom Neue Medien GmbH</b><br>Anglerstrasse 6<br>D-80339 Muenchen<br>Tel: +49 - (0)89 - 500 332 0<br>Fax: +49 - (0)89 - 500 332 22<br>E-mail: support@mitcom.de   |
| <b>France</b>          | <b>Graphics-France</b><br>12 rue des bles<br>93217 Saint Denis La Plaine cedex<br>Tel: + 33 (0)1 49 46 23 40<br>Fax: + 33 (0)1 49 46 23 49<br>E-mail:<br>For any information: newsoft@graphics-france.com<br>For Mr. Photo: mphoto@graphics-france.com<br>For VideoWorks: vworks@graphics-france.com<br>Grapchics France Web site: http://www.graphics-france.com/<br>newsoft |
| <b>Other countries</b> | <b>NewSoft German Representative Office</b><br>E-mail: sales-eu@newsoft.eu.com  |

## Presto! Mr. Photo 3 for Windows

Mr. Photo 3 is a complete package for managing, editing, and sharing your valuable photos and videos. Easily get and arrange photos or videos from digital cameras, scanners, or camcorders. Quickly view thumbnails of, get information about, and search for your photos and videos. With its image processing and printing functions, Mr. Photo 3 lets you share and enjoy easy access to your favorite photos and home movies.

### System Requirements

- Personal computer with 200MHz Pentium processor or higher.
- Microsoft Windows 95/98/98 SE/2000/Me.  
For camcorder or other video device users: Microsoft Windows 98/98 SE/2000/Me.
- 32 MB RAM (64 MB recommended).
- 180 MB free hard disk space for installation.
- A CD-ROM drive.
- Internet Connection: Internet Explorer 4.0 or later.
- (Optional) A Mass Storage-compliant or TWAIN-compliant digital camera or scanner.
- (Optional) A color inkjet printer.
- (Optional) A PC Camera (USB capture device).
- (Optional) Video capture board for capture.
- (Optional) IEEE 1394 card for use with a DV camcorder.
- (Recommended) Display card: SVGA 800X600 True-color.

#### NOTE:

*Because of some system limitations, several Presto! Mr. Photo 3 video functions may not work on Windows 95. We also recommend using IE 5.0 or above.*

## Presto! ImageFolio for Windows

ImageFolio is a complete multimedia image-processing program with a sophisticated set of editing tools. It enables you to process photographs, graphics, and drawings captured from scanners, VCRs, a laser discs, digital cameras, video capture boxes, etc. Whether you choose to create new images or enhance old ones with ImageFolio's powerful tools, your imagination is your only limit!!

### System Requirements

The following hardware devices and software are required to run the software:

- Personal computer with 200 MHz Pentium processor or higher.
- One CD-ROM drive.
- One hard disk drive with at least 60 MB space available.
- At least 32 MB of RAM (preferably 64 MB).
- Microsoft Windows 95/98/2000/Me.

To make full, efficient use of the program, the following additional elements are highly recommended:

- A scanner or digital camera that supports TWAIN or Mass Storage.
- A color printer supported by Microsoft Windows.

## **Presto! Mr. Photo for Macintosh**

Mr. Photo is a complete package for managing, editing, and sharing your valuable photos and videos. Easily get and arrange photos or videos from digital cameras or camcorders. Quickly view thumbnails of, get information about, and search for your photos and videos. With its image processing and printing functions, Mr. Photo lets you share and enjoy easy access to your favorite photos and home movies.

### **System Requirements**

#### **For Mac OS 8.x or 9.x:**

- A Power Macintosh computer.
- At least 32 MB of RAM (preferably 64 MB).
- Minimum 50 MB free hard disk space after installation.
- At least 36 MB virtual memory.
- CD-ROM drive.
- 800×600 display mode or above.

#### **Recommended Equipment**

- A Mass Storage-compliant digital camera or DV camcorder.
- A microphone, soundcard, and speaker.
- A color printer.

## **Presto! PhotoAlbum for Macintosh**

Presto! PhotoAlbum helps you create electronic photo albums to keep your memories alive forever. Just drag photos, frames, clip art, textures, and special effects to add to your album. Personalize them with voice-overs and sound effects. Produce slide shows to post to the Internet or send completed albums by e-mail.

### **System Requirements**

- A Power Macintosh computer.
- At least 32 MB of RAM (preferably 64 MB).
- A hard disk drive with at least 127 MB space available to hold and run the program effectively. (67 MB for the software, and a minimum of 60 MB to be used as virtual memory for efficient use of the program.)
- System 8.x or 9.x.
- A CD-ROM drive.

#### **Recommended Equipment**

- A sound card and a microphone.
- A color printer.

# Installing Mr. Photo Gold

## For Windows:

Follow the steps below to install Mr. Photo 3 and ImageFolio.

- 1** Insert the program CD into your CD-ROM drive.
- 2** Press the **Start** button and choose **Run**.
- 3** Type [drive]:\NewSoft\setup.exe and click **OK**. The installation program will automatically detect the language being used in the version of Windows you are running.
- 4** Follow the instructions on your screen as they appear.

### **NOTE:**

*When you install the program, you can choose to install Adobe Acrobat Reader if you don't have it installed. With Adobe Acrobat Reader, you can view PDF electric manuals.*

## For Macintosh:

To install Mr. Photo and PhotoAlbum:

- 1** Insert the program CD into your CD-ROM drive.
- 2** Open the CD. Double-click on the Mr. Photo Installer or PhotoAlbum Installer icon to start the setup program.
- 3** Follow the on-screen instructions to complete the installation.

### **NOTE:**

*When you install the program, you can choose to install Adobe Acrobat Reader if you don't have it installed. With Adobe Acrobat Reader, you can view PDF electric manuals.*

# MEMO

A series of horizontal dotted lines for writing.