

JVC



LYT2238-002B

EN

HD MEMORY CAMERA

GC-FM2 **U**

GC-WP10 **U** Waterproof with Audio Recording

Detailed User Guide

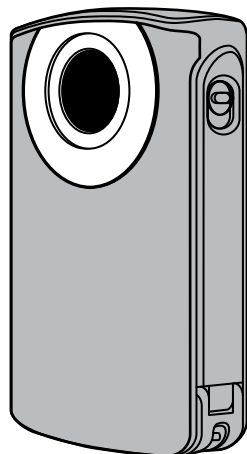

Read this first

Before use, be sure to read "Safety Precautions" (P.2) and "Cautions" (P.3) to use the product correctly.

GC-WP10 is waterproof. Before use in water, be sure to read "Using the Camcorder in Water" (P.25).

HDMI[®]
HIGH-DEFINITION MULTIMEDIA INTERFACE



ENGLISH

Safety Precautions

— Read Before Use —

	CAUTION RISK OF ELECTRIC SHOCK DO NOT OPEN	
CAUTION: TO REDUCE THE RISK OF ELECTRIC SHOCK, DO NOT REMOVE COVER (OR BACK). NO USER-SERVICEABLE PARTS INSIDE. REFER SERVICING TO QUALIFIED SERVICE PERSONNEL.		



The lightning flash with arrowhead symbol, within an equilateral triangle, is intended to alert the user to the presence of uninsulated "dangerous voltage" within the product's enclosure that may be of sufficient magnitude to constitute a risk of electric shock to persons.



The exclamation point within an equilateral triangle is intended to alert the user to the presence of important operating and maintenance (servicing) instructions in the literature accompanying the appliance.

WARNING: TO PREVENT FIRE OR SHOCK HAZARD, DO NOT EXPOSE THIS UNIT TO RAIN OR MOISTURE. (GC-FM2 only)

NOTES:

- The rating plate and safety caution are on the bottom of the unit.
- The serial number plate is on the side of the unit.

Do not point the lens directly into the sun. This can cause eye injuries, as well as lead to the malfunctioning of internal circuitry. There is also a risk of fire or electric shock.

CAUTION!

The following notes concern possible physical damage to the camcorder and to the user. Do not use a tripod on unsteady or unlevel surfaces. It could tip over, causing serious damage to the camcorder.

CAUTION!

Connecting cables (Audio/Video etc.) to the camcorder and leaving it on top of the TV is not recommended, as tripping on the cables will cause the camcorder to fall, resulting in damage.

CAUTION:

- The mains plug shall remain readily operable.
- Remove the mains plug immediately if the camcorder functions abnormally.

WARNING:

The camcorder should not be exposed to excessive heat such as direct sunshine, fire or the like.



If this symbol is shown, it is only valid in the European Union.

IMPORTANT SAFETY INSTRUCTIONS

1. Read these instructions.
2. Keep these instructions.
3. Heed all warnings.
4. Follow all instructions.
5. Do not use this apparatus near water. (GC-FM2 only)
6. Clean only with dry cloth.
7. Do not block any ventilation openings. Install in accordance with the manufacturer's instructions.
8. Do not install near any heat sources such as radiators, heat registers, stoves, or other apparatus (including amplifiers) that produce heat.
9. Protect the power cord from being walked on or pinched particularly at plugs, convenience receptacles, and the point where they exit from the apparatus.
10. Only use attachments/accessories specified by the manufacturer.
11. Use only with the cart, stand, tripod, bracket, or table specified by the manufacturer, or sold with the apparatus. When a cart is used, use caution when moving the cart/apparatus combination to avoid injury from tip-over.
12. Unplug this apparatus during lightning storms or when unused for long periods of time.
13. Refer all servicing to qualified service personnel. Servicing is required when the apparatus has been damaged in any way, such as power-supply cord or plug is damaged, liquid has been spilled or objects have fallen into the apparatus, the apparatus has been exposed to rain or moisture, does not operate normally, or has been dropped.



Recording Medium

- **Be sure to follow the guidelines below to prevent corruption or damage to your recorded data.**

- Do not bend or drop the recording medium, or subject it to strong pressure, jolts or vibrations.
 - Do not splash the recording medium with water.
 - Do not use, replace, or store the recording medium in locations that are exposed to strong static electricity or electrical noise.
 - Do not bring the recording medium near objects that have a strong magnetic field or that emit strong electromagnetic waves.
 - Do not store the recording medium in locations with high temperature or high humidity.
 - Do not touch the metal parts.
- When formatting or erasing data using the camcorder, only the file administration information is changed. The data is not completely erased from the recording medium. If you want to completely erase all of the data, we recommend either using commercially available software that is specially designed for that purpose, or by physically destroying the camcorder with a hammer etc.

LCD Monitor

- **To prevent damage to the LCD monitor, DO NOT**

- ... push it strongly or apply any shocks.
- ... place the camcorder with LCD monitor on the bottom.

- **To prolong service life**

- ... avoid rubbing it with coarse cloth.

- **Do not press the LCD monitor with a sharp-pointed object or press against the surface of the LCD monitor with force when operating the touchscreen.**

This may damage or break the LCD monitor. If you press the LCD monitor at the same time, it may cause a malfunction.

Main Unit

- **For safety, DO NOT**

- ... open the camcorder's chassis.
- ... disassemble or modify the unit.
- ... allow inflammables, water or metallic objects to enter the unit.
- ... place naked flame sources, such as lighted candles, on the apparatus.

- ... expose the apparatus to dripping or splashing. (GC-FM2 only)

- ... insert any objects in the camcorder.

- **Avoid using the unit**

- ... in places subject to excessive humidity or dust.

- ... in places subject to soot or steam such as near a cooking stove.

- ... in places subject to excessive shock or vibration.

- ... near a television set.

- ... near appliances generating strong magnetic or electric fields (speakers, broadcasting antennas, etc.).

- ... in places subject to extremely high (over 40 °C or 104 °F) or extremely low (under 0 °C or 32 °F) temperatures.

- **DO NOT leave the unit**

- ... in places of over 50 °C (122 °F).

- ... in places where humidity is extremely low (below 35%) or extremely high (above 80%).

- ... in direct sunlight.

- ... in a closed car in summer.

- ... near a heater.

- ... in high places such as on a TV. Leaving the unit in high places while a cable is connected may result in a malfunction if the cable is caught and the unit falls onto the floor.

- **To protect the unit, DO NOT**

- ... allow it to become wet. (GC-FM2 only)

- ... drop the unit or strike it against hard objects.

- ... subject it to shock or excessive vibration during transportation.

- ... keep the lens directed at extremely bright objects for long periods.

- ... expose the lens to direct sunlight.

- ... swing it excessively when using the hand strap.

- ... swing the soft camcorder case excessively when the camcorder is inside it.

- ... store the camcorder in a dusty or sandy area.

- **To prevent the unit from dropping,**

- When using the camcorder with a tripod, attach the camcorder to the tripod securely. If the camcorder drops, you may be injured and the camcorder may be damaged. When a child uses the unit, there must be parental guidance.

Cautions (Continued)

Battery

- **When using the unit in a low temperature environment (10°C (50°F) or below), the operating time may be shortened, or it may not function properly.**

Keep the unit warm by keeping it in a pocket when using the unit out of doors in winter. (Do not expose the unit to heat directly such as a pocket warmer.)

- **When you leave the unit unused for a long period of time, run down the battery to prevent the battery from being depleted. (Leave the unit recording or playing until the unit is turned off automatically.)**

Recharge the battery, and then run it down about every 6 months.

ATTENTION: The product you have purchased is powered by a rechargeable battery that is recyclable.



Please call 1-800-8-BATTERY for information on how to recycle this battery. (USA and Canada only)

Waterproof Function (GC-WP10 only)

- **Before using the camcorder in water, be sure to read "Using the Camcorder in Water" (P.25) and to use the product correctly.**
- Malfunction due to misuse by the customer is not covered by warranty.
- Do not use this product in water deeper than 3 m (10 ft) or for longer than 30 minutes.

Video Function

- **The unit records video in Mpeg-4 AVC/H.264 format for video and AAC (2ch) format (GC-WP10: stereo, GC-FM2: monaural) for audio.** You cannot play back the recorded video using a component which does not support these formats.

Audio Function

- **Audio cannot be played back on HD Media Player CU-VS100/JVC.**

Remember that this camcorder is intended for private consumer use only.

Any commercial use without proper permission is prohibited. (Even if you record an event such as a show, performance or exhibition for personal enjoyment, it is strongly recommended that you obtain permission beforehand.)

Trademarks

- HDMI is a trademark of HDMI Licensing, LLC.
- Microsoft, Windows and Windows Vista are registered trademarks of Microsoft Corporation in the United States and/or other countries.
- Intel, Intel Core, and Pentium are trademarks or registered trademarks of Intel Corporation or its subsidiaries in the United States and other countries
- Macintosh, QuickTime are registered trademark of Apple Inc. registered in the U.S. and other countries.
- Eye-Fi is a trademark of Eye-Fi, Inc.
- Other product and company names included in this instruction manual are trademarks and/or registered trademarks of their respective holders.



Key features of camcorder

1. Full HD (1920 x 1080 / 30 fps) video recording
2. 3 inch touch screen
3. Electronic camera shake correction
4. Easy uploading to YouTube with the supplied software LoiLoScope EX
5. Eye-Fi card compatible: Uploading videos & still images via Wi-Fi network
6. iFrame video format recording (ideal for video editing with iMovie)
7. HDMI output connector
8. Waterproof design within 3 m/10 ft, 30 minutes (GC-WP10 only)
9. MP3 voice recorder (GC-WP10 only)

Daily Maintenance

Be sure to turn off the power and detach the cables before performing any maintenance.

Camcorder	<ul style="list-style-type: none">● Wipe this unit with a dry, soft cloth to remove any dirt.● When it is extremely dirty, soak the cloth in a solution of neutral detergent, wipe the body with it, and then use a clean cloth to remove the detergent. <p>CAUTION</p> <ul style="list-style-type: none">● Do not use benzene or thinner. (Cause of damage to or malfunction of the unit)● When using a chemical cloth or other products, be sure to observe the instructions of the product.● Do not leave the device in contact with rubber or plastic products for a long time.
Lens/LCD Monitor	<ul style="list-style-type: none">● Use a lens blower (commercially available) to remove any dust, and a cleaning cloth (commercially available) to wipe off any dirt. (Mold may form if the lens is left dirty.)● Perform [TOUCH SCREEN ADJUST] (P.45) if the reactive area of the screen is misaligned with the touched area. (Adjust by lightly tapping with a corner of an SD card, etc. Do not press with an object with a sharp tip or do not press hard.)

- See page 27 for maintenance after recording in water. (GC-WP10 only)

Table of Contents

Safety Precautions	2
Cautions.....	3
Daily Maintenance.....	5
Table of Contents	6
Names and Functions of Components.....	7
Indications on LCD Monitor.....	8
Getting Started	
Accessories	11
Attaching the Core Filter to the USB Cable.....	11
Attaching the Hand Strap (GC-WP10 only)	11
Inserting an SD Card	12
Charging the Battery.....	14
Using the Touchscreen	16
Clock Setting.....	18
Recording	
Recording Video/Still Images.....	20
Useful Functions for Recording.....	23
Using the Camcorder in Water (GC-WP10 only)	25
Playback	
Playing Back on the Camcorder.....	28
Deleting Files	30
Copying a Part in the Video (Trimming)	31
Viewing Files on TV.....	32
Audio Recording	
Recording Audio (GC-WP10 only)	33
Audio Playback	
Playing Back Audio on the Camcorder (GC-WP10 only)	34
Delete Audio Files (GC-WP10 only)	37
Copying a Part in the Audio (GC-WP10 only)	38
Connecting with a Computer	
Make a Backup on Computer.....	39
Using the Supplied Software	40
Using an Eye-Fi Card.....	42
Menu	
Using the Menu	44
Further Information	
Troubleshooting	46
Specifications.....	49
Approximate Time/Number of Recording.....	50
Customer Support Information	52
Index	53

Names and Functions of Components

GC-WP10

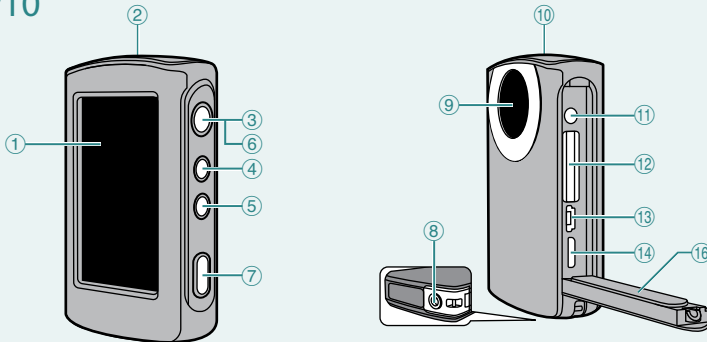

GC-FM2

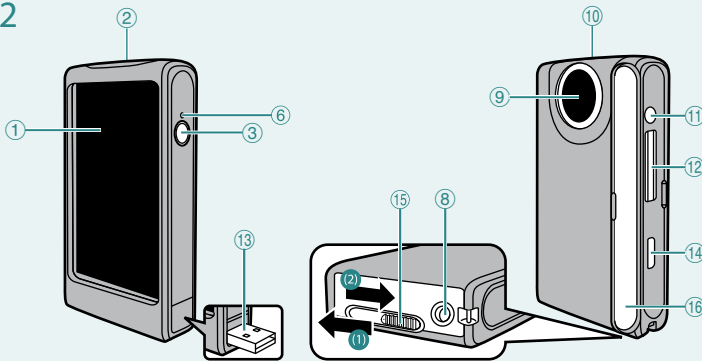

- ① LCD Monitor
- ② Speaker
- ③ Power Button [⏻]
- ④ SCREEN LOCK Button (P.26)
(GC-WP10 only)
- ⑤ Video/Still Image Select Button [📷/📹]
(GC-WP10 only)
- ⑥ POWER/CHARGE Lamp
- ⑦ Recording Button (P.20)(GC-WP10 only)
- ⑧ Tripod Mounting Socket
- ⑨ Lens

- ⑩ Microphone
GC-WP10: Stereo
GC-FM2: Monaural
- ⑪ AV Connector (P.32)
GC-WP10: also serves as Headphones Connector
- ⑫ SD Card Slot (P.12)
- ⑬ USB Connector (P.14, 39)
- ⑭ HDMI Mini Connector (P.32)
- ⑮ USB Connector Lever (GC-FM2 only)
(1): Push the connector out
(2): Retract the connector
• Press-and-hold the lever and slide
- ⑯ Cover

Indications on LCD Monitor

Top Menu

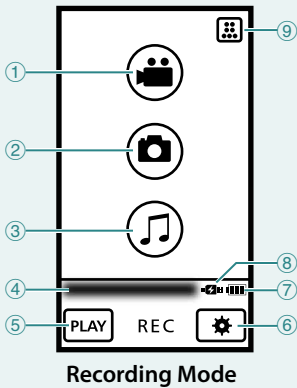

Recording Mode

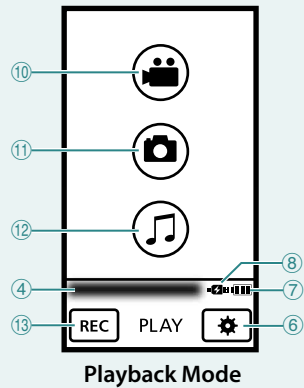

Playback Mode

- ① Video Recording Button (P.20)
- ② Still Image Recording Button (P.20)
- ③ Audio Recording Button (P.33)
(GC-WP10 only)
- ④ Time
- ⑤ Play Select Button
- ⑥ Basic Settings Button (P.44)
- ⑦ Battery Indicator (P.15)
- ⑧ AC Adapter
 - ⚡ When connected
 - ⚡✗ When inoperative
 When both of the Battery indicator and AC adapter icons are displayed, the power is supplied through the both.
- ⑨ Video Recording Mode Select Button (P.21)

- ⑩ Video Playback Button
- ⑪ Still image Playback Button
- ⑫ Audio Playback Button (GC-WP10 only)
- ⑬ Recording Select Button

During Recording

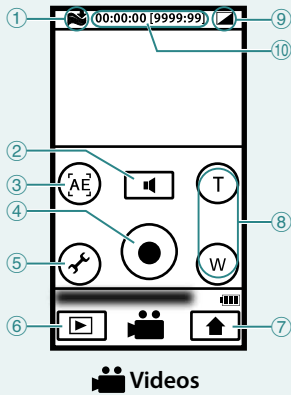

Videos

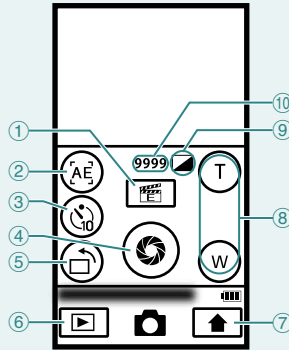

Still images

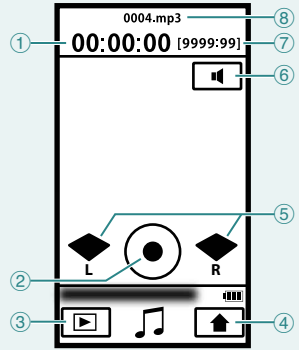

**Audio
(GC-WP10 only)**

Videos

- ① WIND CUT [ON] (P.45)
- ② Headphones Volume Button
(GC-WP10 only)
- ③ AE Select Button (P.23)
(GC-WP10 only)
- ④ Recording Start/Stop Button
- ⑤ Menu Settings Button (P.44)
- ⑥ Play Select Button
- ⑦ Top Menu Button
- ⑧ Zoom Buttons
- ⑨ EFFECT (P.45)
- ⑩ Counter/Remaining Time

Audio (GC-WP10 only)

- ① Counter
- ② Audio Recording Start/Stop Button (P.33)
- ③ Play Select Button
- ④ Top Menu Button
- ⑤ Microphone Input Level
- ⑥ Headphones Volume Buttons
- ⑦ Remaining Time
- ⑧ Audio Recording File Name

Still images

- ① Menu Settings Button (P.44)
- ② AE Select Button (P.23)
(GC-WP10 only)
- ③ Self Timer (10 Seconds/OFF) Select Button
- ④ Recording Button
- ⑤ Recording Direction Select Button (P.22)
- ⑥ Play Select Button
- ⑦ Top Menu Button
- ⑧ Zoom Buttons
- ⑨ EFFECT (P.45)
- ⑩ Remaining Number of Shots

Playback Index Screen

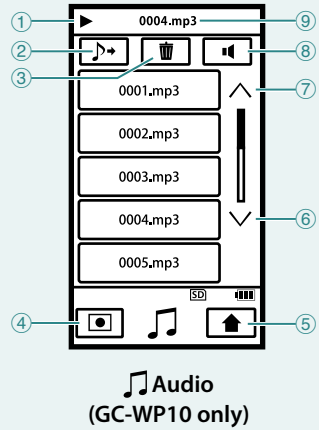
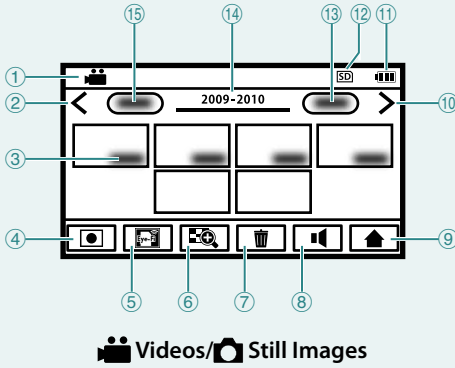

Videos/ Still Images

- ① Video (MP4)/ Still Image (JPG)
- ② Previous Page Button
- ③ Recorded Date
- ④ Recording Select Button
- ⑤ Eye-Fi SETTING Button (P.42, only when using Eye-Fi card)
- ⑥ Zoom Display Button (P.28)
- ⑦ Delete Button (P.30)
- ⑧ Volume Button (P.28)
- ⑨ Top Menu Button
- ⑩ Next Page Button
- ⑪ Battery Indicator (P.15)
- ⑫ Recording Media
SD card
- ⑬ Next Date Button
- ⑭ Recorded Year
- ⑮ Previous Date Button

Audio (GC-WP10 only)

- ① Playback Operation
- ② External File Button (P.36)
- ③ Delete Button (P.37)
- ④ Recording Select Button
- ⑤ Top Menu Button
- ⑥ Next Page Button
- ⑦ Previous Page Button
- ⑧ Volume Button (P.34)
- ⑨ File in Playback

Accessories

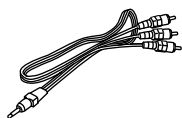

Dedicated AV Cable

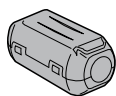

Core Filter

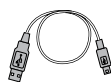

USB Cable
(Type A – Type B Mini)
(GC-WP10 only)



USB Extension Cable
(GC-FM2 only)

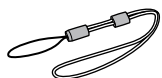

Hand Strap
(GC-WP10 only)

NOTE

- You can use the hand strap attached to the camcorder under water.

Optional accessory	Page
AC adapter (AC-V10LU)	(P.15)
SD card / SDHC card / SDXC card	(P.12)
Eye-Fi card	(P.42)

Attaching the Core Filter to the USB Cable

GC-WP10: Attach the core filter to the USB cable.

GC-FM2: Attach the core filter to the USB extension cable.

The core filter reduces noise generated when connecting the camcorder to an external component. Connect the end of the cable with the core filter to the camcorder.

Release the both stoppers.

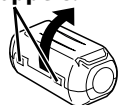

3 cm (1-3/16")

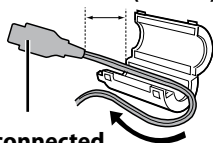

To be connected to the camcorder.

Wind once.

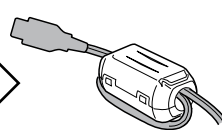
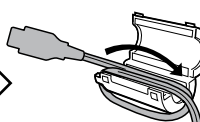

NOTE

- Be sure to use the USB cable or the USB extension cable with the core filter attached when connecting the camcorder to the AC adapter or a computer.

Attaching the Hand Strap (GC-WP10 only)

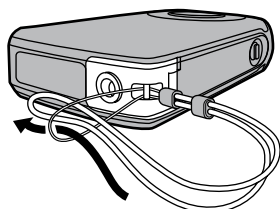

To guard against dropping the camcorder, we recommend attaching the hand strap.

NOTE

- When carrying the camcorder, please be careful not to drop it. Dropping it may cause injury or a malfunction of your camcorder.
- When a child uses the camcorder, there must be parental guidance.

Inserting an SD Card

GC-WP10

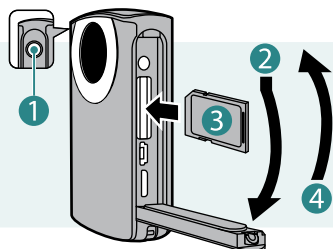

GC-FM2

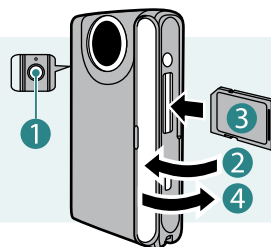

- 1 Press the  button (1) for about 1 second to turn off the camcorder.
The power lamp goes out.
- 2 Open the cover (2).
- 3 Insert an SD card (3).
Turn off the power of this unit before inserting or removing a card.
- 4 Close the terminal cover (4) firmly.

To remove an SD card

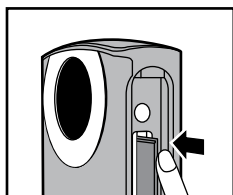

Push the card inward once, then pull it out straight.
Be sure to insert the SD card with the power turned off.

NOTE

- To protect data, do not touch the terminals of the SD card.
- Operations are confirmed on the following SD cards. (P.13)

Manufacturer	Panasonic, TOSHIBA, SanDisk, ATP, Eye-Fi
Video recording	Class 4 or higher compatible SD card (2 GB) Class 4 or higher compatible SDHC card (4 GB to 32 GB), or Class 4 or higher compatible SDXC card (48 GB to 64 GB) For ATP, only Class 4 or higher compatible SDHC card (up to 16GB)
Still image recording/ Audio recording	SD card (256 MB to 2 GB), SDHC card (4 GB to 32 GB), or SDXC card (48 GB to 64 GB) For ATP, only SD card or SDHC card (up to 16GB)

- If other SD cards, SDHC cards or SDXC cards than the above are used, they may fail to record data correctly, or they may lose data that had already been recorded.
- The Eye-Fi card is a SD type memory card with built-in wireless LAN. You can transfer videos and still images to a computer or the Web via the Eye-Fi card. (An Internet accessible environment and a wireless LAN router are separately required.)
See page 42 to use an Eye-Fi card.

When your computer cannot recognize the SDXC card

Confirm and upgrade the OS of your computer.

Windows XP / Windows XP SP1	Not compatible. Necessary to upgrade to SP2 or higher.
Windows XP SP2 / Windows XP SP3	Necessary to download the upgrade software. (KB955704) http://www.microsoft.com/downloads/details.aspx?FamilyID=1cbe3906-ddd1-4ca2-b727-c2dff5e30f61&displaylang=en
Windows Vista	Not compatible. Necessary to upgrade to SP1 or higher.
Mac OS	Not compatible.

Charging the Battery

GC-WP10

GC-FM2

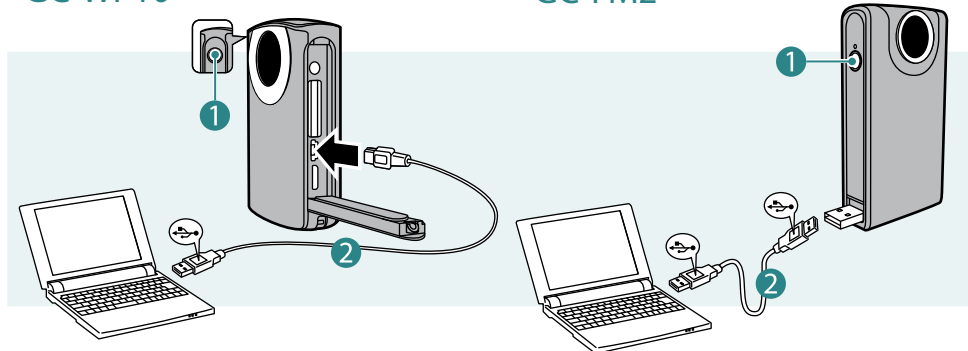

1 Turn off the camcorder by pressing the  button (1) for about 1 second.

The power lamp goes out.

2 Turn on the computer and connect to the camcorder (2).

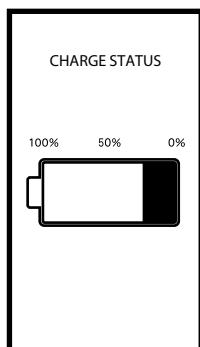

Charge Lamp	Blinks: Charging
	Goes out: Charging finished
Charging Time	Approx. 3 h

You can confirm the remaining battery level by touching the screen (for about 1 second) during charging. (You cannot confirm the level when the battery is extremely low.)





When the charging is finished, disconnect the camcorder from the computer.

NOTE



- The charging time is when the camcorder is charged at 25°C (77 °F). If the battery is charged outside the room temperature range of 10 °C (50 °F) to 35 °C (95 °F), charging may take a longer time or it may not start. The recordable and playable time may also be shortened under some usage conditions such as at low temperature.
- Charging is not possible while the camcorder is turned on.

- The battery is not charged at the time of purchase. Charge before starting to use the camcorder.
- When the battery level is extremely low, the camcorder does not turn on until it is charged even if it is connected to the computer or AC adapter.
- Do not turn the computer off or into the sleep mode during charging (the charging will stop).
- With some types of computers, charging is possible even when the computer is turned off. Refer to instruction manual of the computer or consult with the manufacturer of your computer.
- You cannot record or play back video/still image/audio while the camcorder is connected to a computer. You can record or play back video/still image/audio while the AC adapter is connected to the camcorder.

Indication when using the battery

	Fully charged
	Medium
	Very low
	Recharge the battery at an early opportunity.

Indication when using the AC Adapter

 (When connected)	When both of the Battery indicator and AC adapter icons are displayed, the power is supplied through the both.
 (When inoperative)	

Charging with the AC Adapter (optional)

Optional accessory: AC-V10LU/JVC

GC-WP10

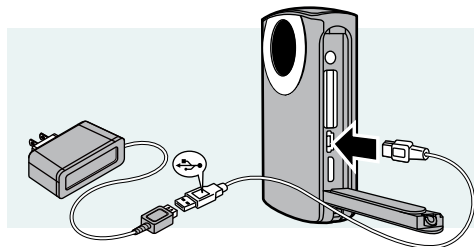

GC-FM2

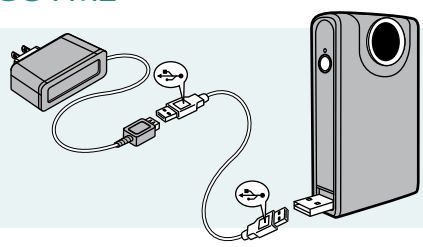

GC-WP10	Connect with the AC adapter using the supplied USB cable.
GC-FM2	Connect the USB connector of this unit with the AC adapter. (You can connect also using the supplied USB extension cable.)

Using the Touchscreen

The following are some examples.

Touch to Select

■ To select Video/Still Image/Audio on the Top Menu (Audio is for GC-WP10 only.)

Touch  to return to the Top Menu and select the mode.

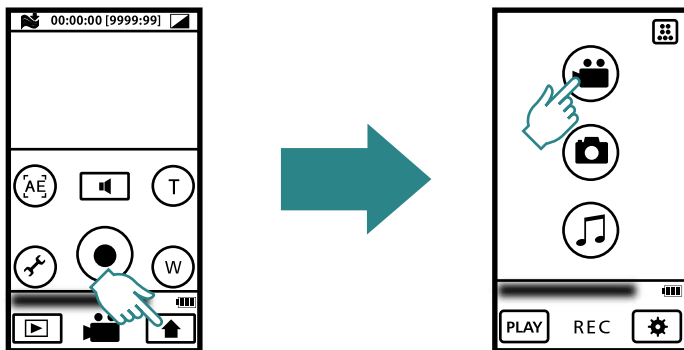

■ Recording

Touch to start/stop recording.

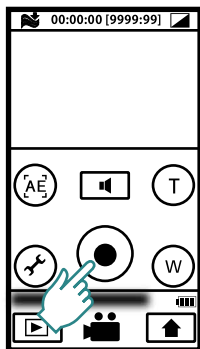

■ Playback

Touch the thumbnail of the desired scene to play back.

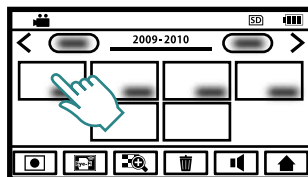

MEMO

- The touchscreen of this unit is pressure-sensitive. When the touchscreen does not respond smoothly, apply slightly more force to your fingertip.

To search for the desired scene

Press the page switching button (1) or the date switching button (2) to search for the desired scene.

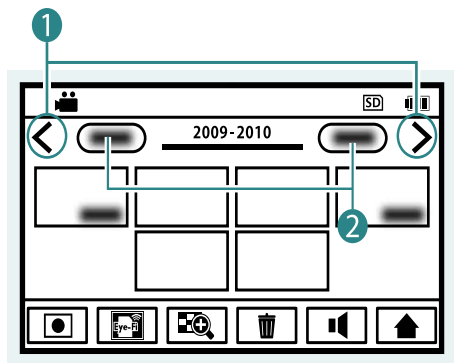

MEMO

- The touchscreen of this unit is pressure-sensitive. When the touchscreen does not respond smoothly, apply slightly more force to your fingertip.
- Do not press or rub with excessive force.
- If you apply a protect sheet or a sticker, the touchscreen may not respond smoothly.
- Do not operate the touchscreen using an object with a sharp or hard tip.
- Touching two or more places at a time may cause a malfunction.
- Perform [TOUCH SCREEN ADJUST] (P.45) if the reactive area of the screen is misaligned with the touched area. (Adjust by lightly tapping with a corner of an SD card, etc. Do not press with an object with a sharp tip or do not press hard.)

Clock Setting

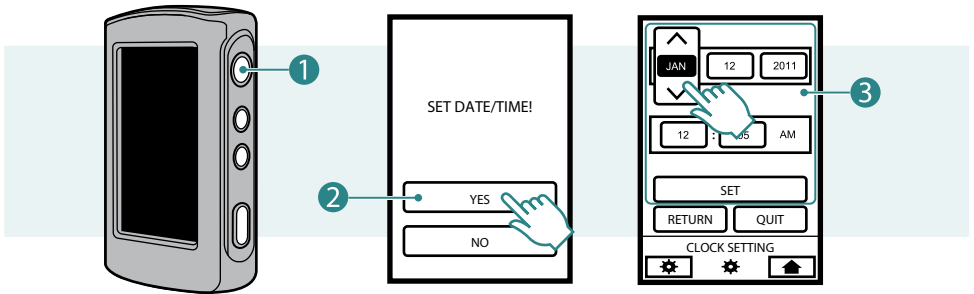

1 Press the **⏻** button (1) for about 1 second to turn on the camcorder.
The power lamp turns on.

2 Touch **[YES (2)]** when the **[SET DATE/TIME!]** screen appears.

3 Set the date and time (3).

- Touch the month, day, year, hour and minute to select it.
- Touch **^** **v** to make adjustments.
- After setting the date and time, touch **[SET]**.

4 Set the region where you live and touch **[SAVE]**.
The city name and time difference are displayed.
Touch **<** **>** to make adjustments.

To reset the clock

Set the clock with **[CLOCK ADJUST]** from the Basic Settings. (P.45)

- 1 Press the **⏻** button to turn on the camcorder.
- 2 Touch **⚙** on the top menu.
- 3 Touch **[CLOCK ADJUST]**.
- 4 Touch **[CLOCK SETTING]**.

The subsequent procedure is same as in the Steps 3 and 4 of "Clock Setting".

NOTE

- The [SET DATE/TIME!] screen does not appear when the date and time are already set.
- The [SET DATE/TIME!] screen appears when the camcorder has not been used for a long time. Charge the battery before setting the clock. (P.14)
- When using this unit abroad, change the date and time display to the local time by simply selecting your travel destination in [AREA SETTING]. (P.45)

Recording Video/Still Images

Before recording an important scene, it is recommended to conduct a trial recording.

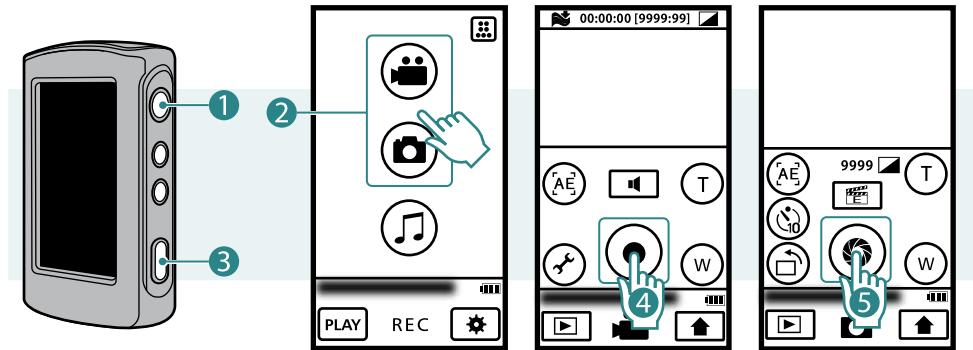

1 Press the  button (1) for about 1 second to turn on the camcorder.

2 Select video or still image mode (2) from the Top Menu.
When you turn on the power, the Top Menu appears only for the first time after purchasing the camcorder.

To return to the Top Menu, touch  during video or still image recording.

3 Start recording.

 For Videos

Touch the Recording START/STOP button (4).

Touch it again to stop recording.

GC-WP10: You can make recording also with a press of the Recording button (3).

 For Still Images

Touch the SNAPSHOT button (5).

To shoot continuously, keep touching the button.

GC-WP10: You can shoot still image also with a press of the Recording button (3).

To shoot in landscape mode, follow the same procedure.

NOTE

- After video recording for 12 consecutive hours, recording automatically stops.

- For continuous video recordings of long consecutive hours, the file is split into pieces automatically either in every 30 minutes or if the size exceeds 4 GB.
- Using the AC adapter (optional), you can record for long consecutive hours.
- To prevent the situation of forgetting to turn off the power, if this unit is not operated for 5 minutes, the power is turned off automatically.
- Brightness of the LCD monitor increases when recording in bright light. The LCD monitor increases brightness when the AC adapter is connected to the camcorder. However, it returns to normal brightness when you do not operate the camcorder during video recording for 5 minutes. (LCD \square \square \square \square \square / LCD \square \square \square \square \square is displayed for about 3 seconds at the moment of switching.)

Change the Recording Quality (📹 video only)

Preparation: 📹 Video recording

1 Touch .

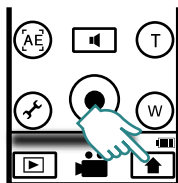

2 Touch .

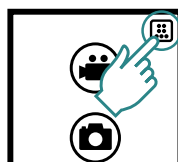

3 Select the recording quality.

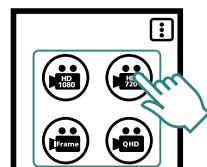

HD 1080	When you place priority on Video Quality 1920 × 1080 / 30p
HD 720	When you place priority on motion of the video 1280 × 720 / 60p
iFrame	When you use the video in Apple iMovie '09 960 × 540 / 30p
QHD	When you make a long-duration recording 960 × 540 / 30p

- Recording at Intervals (TIME-LAPSE RECORDING) (P.24)

Switching the Image Orientation (📷 Still Image Recording only)

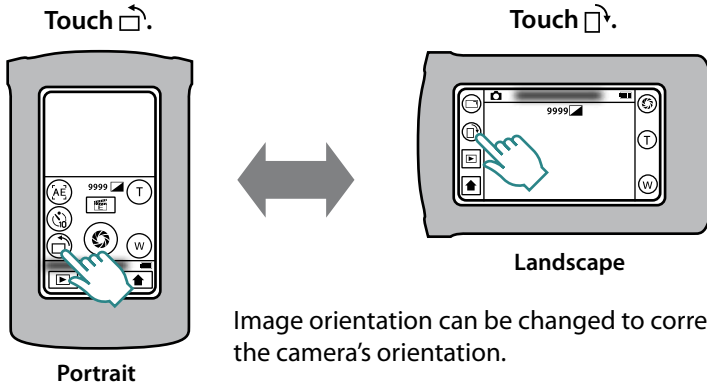

To use functions in landscape mode

1 Touch .

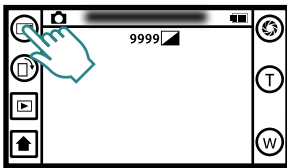

2 Select the function to use.

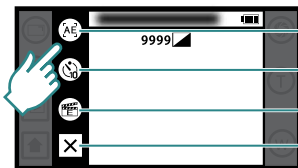

- Touch AE, Face Priority AE Switching (P.23)
- SELF-TIMER
- Menu Settings (P.45)
- QUIT

3 Touch .

Quit.

NOTE

- The size of still images differs between the portrait and the landscape modes.
Portrait mode: 2592 × 1944 (5M)
Landscape mode: 1440 × 1920 (2.7M)
- The image orientation do not switch automatically. Switch it according to the actual orientation of the camcorder.
- Video is not output through the AV cable when the Image Orientation is set to Portrait.
- Video is not output at 480i or 480p through the HDMI cable when the Image Orientation is set to Portrait.

Useful Functions for Recording

Adjusting the brightness based on the touched area (Touch AE)

Preparation:  Video/  Still image recording

1 Touch AE. (GC-WP10 only)

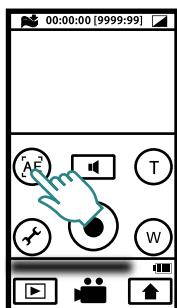

With every touch, Touch AE and Face Priority AE alternate.

2 Touch the area to adjust.

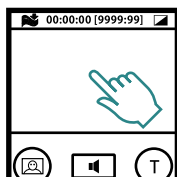

With the touch, a frame appears in which exposure is adjusted. The frame disappears if you touch the frame or if you use zoom function.

Shooting Human Subjects (Face Priority AE) (GC-WP10 only)

Preparation:  Video/  Still image recording

1 Touch .

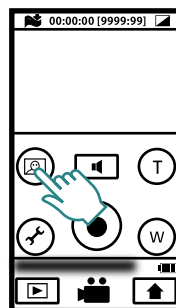

With every touch, Touch AE and Face Priority AE alternate.

Frames appear on human faces in which exposure is automatically adjusted.

NOTE

- Up to 16 frames on faces can be displayed in total. You cannot choose the frame to adjust exposure arbitrarily.
- Depending on the condition, faces may not be detected.
- If you cannot get proper effect, turn off the Face Priority AE.

Recording at Intervals (TIME-LAPSE RECORDING)

This function enables the changes of a scene that occur slowly over a long period to be shown within a short time by taking frames of it at a certain interval.

Preparation:  Video recording

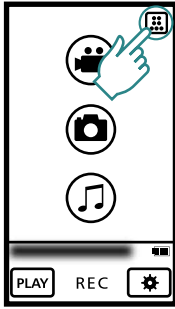

1 Touch  to display the Top Menu and touch .

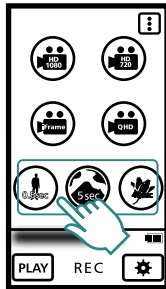

2 Select a recording interval.



Recording interval/Playback speed

	0.5 second/30 times
	5 seconds/300 times
	40 seconds/2400 times

3 Touch the Recording START/ STOP button **(1)**.

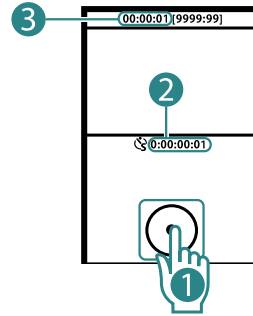

Recorded Time **(2)**

Actual Elapsed Time **(3)**

NOTE

- Audio cannot be recorded during time-lapse recording.
- Zooming is not available in time-lapse recording.
- When recording is stopped with the recorded time less than "0:00:00:17", the video will not be saved.
- Recording stops automatically 99 hours after it is started.
- Make use of a tripod and optional AC adapter for time-lapse recordings with long intervals. (optional: AC-V10LU/JVC)
- The recording quality during time-lapse recording is the same as that of HD 720 (P.50).

Using the Camcorder in Water (GC-WP10 only)

After use in water, rinse the camcorder with fresh water, then wipe off and dry it well in a well-ventilated place out of direct sunlight as soon as possible. (P.27)

Before use

Confirm that there is no foreign material inside the terminal cover. (Foreign material causes ingress of water.)

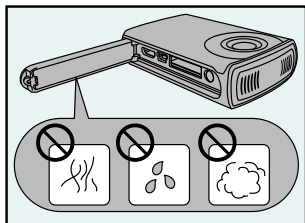

- Make sure that there is no damage to and no foreign material (hair, lint, sand, dust, fluid etc.) adhered to the packing inside the cover, the SD card slot, or the parts around the connectors.
- If you find damage, do Not use the unit. Consult your JVC dealer or the nearest JVC service center.

Close the terminal cover firmly.

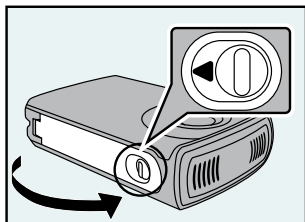

- Close the cover firmly until it clicks into place.
- Confirm that the red sign completely goes off.

CAUTION

- This camcorder is equipped with a waterproof function corresponding to JIS (Japanese Industrial Standards) IPX8. This camcorder can make recordings in marine water and fresh water not deeper than 3 m (10 ft) or for not more than 30 minutes. (The waterproof capability is tested in accordance with JVC test standard and it does not assure damage-free or trouble-free operation. Waterproof function not evaluated by UL.)
- Do not soak the camera in hot springs or water of 40 °C (104 °F) or higher.
- Do not subject the camcorder to high water pressure such as in torrent or fall, or to excessive pressure or impact such as by diving with the camcorder in hand.
- The waterproof capability cannot be guaranteed if the camcorder is subject to impact such as dropping. Consult with the dealer if the camcorder is subject to impact.
- The camcorder sinks in water. Use the strap to prevent it from falling.
- Open and close the cover in a dry place, after wiping moisture off the camcorder.
- Wipe off immediately if such liquids as detergent solution, soap water, hot spring water, bath agent, oil, sunscreen lotion or chemical liquid are spilled on the camcorder.
- When used in water, at first, air bubbles may come out of the unit but it is not a malfunction.

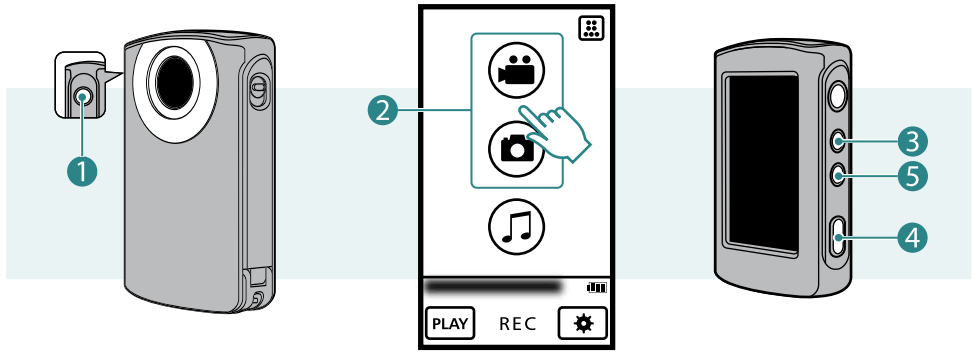

1 Press the button (1) for about 1 second to turn on the camcorder.

2 Select Video or Still Image mode (2) on the Top Menu.

3 Press the SCREEN LOCK button (3) for more than 1 second.

- When using this unit in water, temporarily disable the touchscreen so that it will not malfunction with the water pressure.
- HOLD is displayed on the screen.
- Press the Recording button (4) to record.
- Press the SCREEN LOCK button again, for more than 1 second, to turn off HOLD and activate the touchscreen.

To select video recording/still image recording in water

Pressing the button (5) will toggle the operation between Video Recording and Still Image Recording.

Audio recording is not selectable in water.

After use

After use in water or when dusted with sandy dust, rinse the camcorder with fresh water and dry it well as soon as possible.

1 Press the button for about 1 second to turn off the camcorder.

Make sure that the connector cover is closed tightly.

2 Rinse with fresh water.

Soak and wash in an appropriate depth of still fresh water in basin.

Push aside the buttons to wash off the dirt in the gap.

Do not rinse with chemicals, soap, neutral detergent or alcohol.

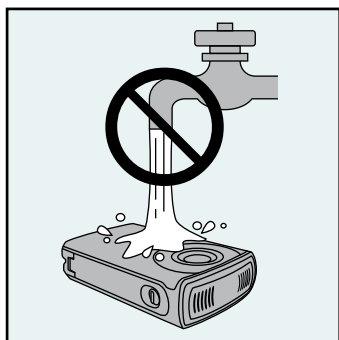

Do not apply current of water such as tap water directly to this unit.

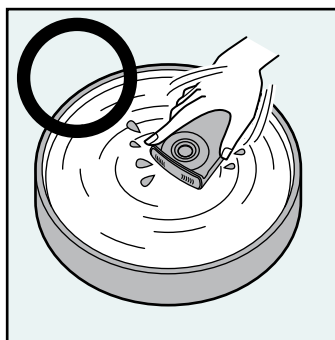

3 Dry.

Wipe off with a dry soft cloth and dry in a well-ventilated place out of direct sunlight. There may be water near the microphone. Therefore, aim the camcorder downward and remove the water.

Wiping with some sand remaining can cause a scratch. Wipe after rinsing the sand off.



Also, wipe off strange materials and water drops inside the cover.

CAUTION

- Do not dry with heat such as by using a hairdryer. The waterproof capability will deteriorate.
- Do not leave the camcorder for long time in low temperature environment in cold climates or in heat of 40 °C (104 °F) or higher (such as under sun light, in a sun-heated car or near the heater). The waterproof capability will deteriorate.
- After use in marine water, soak in adequate amount of fresh water approximately 10 minutes and rinse with fresh water in order to clean off the salt.
- Do not leave the camcorder soaked in or wet with salt water. It may cause corrosion, tarnish, or deterioration of water resistance.
- Remove the strap from camera and rinse the strap with fresh water.
- Do not connect cables or charge with water drops remaining.
- JVC cannot be held responsible of any loss of data due to ingress of water into the unit.
- It is recommended to replace the packing (optional) once a year to maintain the waterproof capability. Consult your nearest JVC service center. (P.52)

Playing Back on the Camcorder

Select a video or still image to play back from the index screen.

Preparation:  Video recording/  Still image recording

1 Touch .

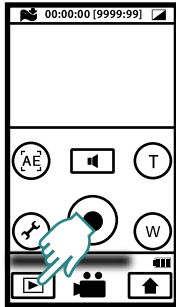

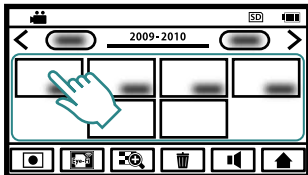

The camcorder turns to playback mode.

2 Select a file.



If you touch , the thumbnail images will enlarge.

Touch and drag the thumbnail display left and right or touch   to move to another page.





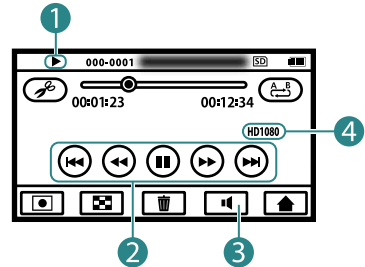

If a shooting duration of still images is within 2 seconds, they are displayed as one thumbnail (group).

3 Play back a file.

Touch the screen to display screen messages and operation buttons (2). (They will disappear if touched again.)



Operation modes (1)

-  Playback
-  Reverse playback
-  Pause
-  Forward search
-  Reverse search
-  Forward slow-motion
-  Reverse slow-motion

Touch  to stop playback.

Operation Buttons (2) (P.29)

Adjust the volume (3)

Touch +/- to make adjustments and touch  to quit.

Video quality (4)

Operation Buttons (during Video Playback)

-  Playback

-  Pause

-  Advances to the next video

-  Returns to the beginning of the scene

-  Forward search

-  Reverse search

-  Forward slow-motion

-  Reverse slow-motion

Operation Buttons (during Still Image Playback)

-  Start slideshow

-  Stop slideshow

-  Advances to the next still image

-  Returns to the previous still image

-  Play back a group continuously

Repeated Playback of a Part (A-B Repeat)

Preparation:  Video playback

- 1 Play back the video, then touch  at the starting/end points.

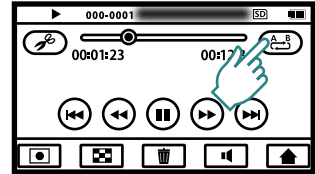

With every touch, the setting toggles as shown below.

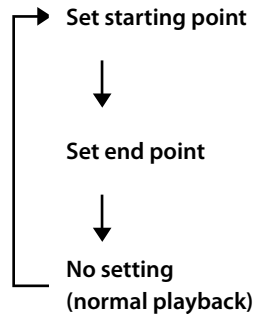

NOTE

- A-B repeat is possible only within one scene.
- The setting is canceled if Stop is selected after the end point is set.

Deleting Files

Preparation:  Video/  Still image playback

NOTE

- You can delete the files by touching  during video/still image playback.

1 Touch .

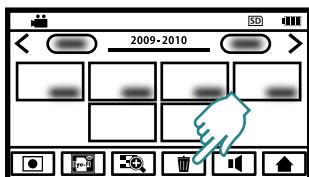

2 Touch the video/still image file to delete.

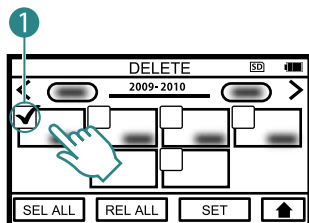

A check mark  appears on the selected video/still image.

If you touch the video/still image with a check mark, the selection is cancelled.

Touch [SEL ALL] to select all the video/still image files.

Touch [REL ALL] to cancel all the selection.

3 Touch [SET].

4 Touch [DELETE] when the confirmation message appears.

Copying a Part in the Video (Trimming)

Preparation:  Video playback

- 1 Play back the video, then touch .

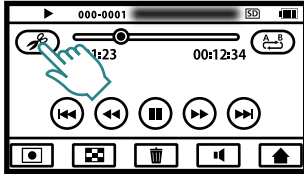

- 2 Pause playback at the starting point and touch **A**.

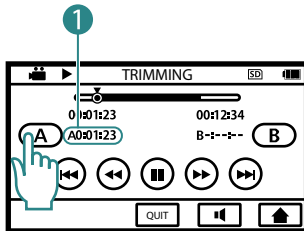

Copy starting point (1)

- 3 Resume playback, pause at the end point and touch **B**.

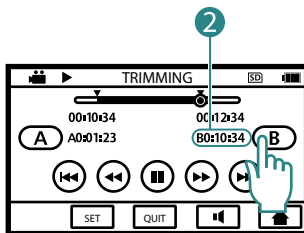

Copy end point (2)

- 4 Touch [SET].

- 5 Touch [YES] when the confirmation message appears.

When copying finishes, the copied file is added to the index screen.

NOTE

- When you copy a part of the video, the division point may not be accurate within a 1 second margin of error.

Viewing Files on TV

Preparation:

- Turn on the TV.
- Turn on the power (1) of the camcorder and select the playback mode.

To connect using the dedicated AV cable (provided)(2)

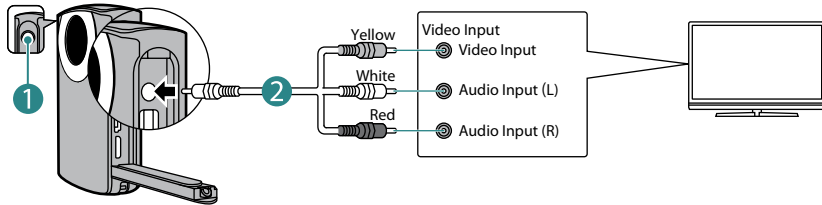

To connect using the HDMI mini cable (optional)(3)

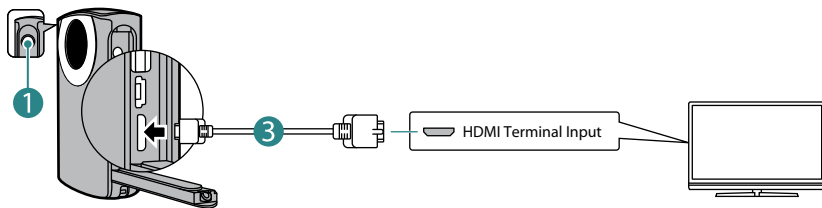

- 1 Connect the camcorder to a TV.
- 2 Switch to the TV's external input connector.
- 3 Start the playback. (P.28)

NOTE

- Use the supplied AV cable. Otherwise, image and sound cannot be output.
- If the AV cable or HDMI cable is disconnected during playback, the playback will be paused.
- When an AV cable and an HDMI cable are connected, output to the HDMI cable is prioritized.
- Also refer to instruction manual of the TV.
- We recommend using the Category 2 HDMI cable (High Speed cable).
- Insert the connector in the right direction. Forcing the connector into the terminal may cause damage.
- If you connect the camcorder using the AV cable, image is output only when playing back video. If you connect the camcorder using the HDMI Mini connector, image is output when both playing back and recording video. However, if you connect the camcorder to a TV with 480p or 480i resolution, image is output only when playing back video.
- Image is not output during the audio recording and audio playback.

Recording Audio (GC-WP10 only)

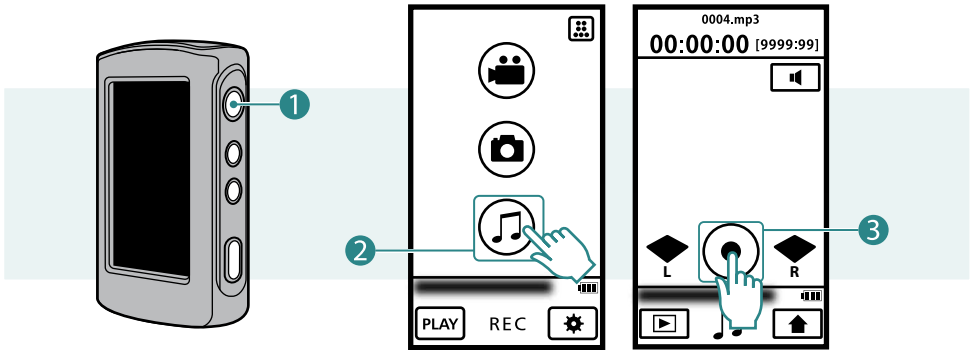

- 1** Press the  button(1) for about 1 second to turn on the camcorder.
- 2** Touch Audio mode(2) on the Top Menu.
To return to the Top Menu, touch  in the audio recording screen.
- 3** Touch the Recording START/STOP button(3).
Audio recording starts.
Touch again to stop audio recording.

NOTE

- If you record audio 12 hours continuously, it will stop recording automatically.

Playing Back Audio on the Camcorder (GC-WP10 only)

You can select and play back the recorded audio from an index screen.

Preparation: 🎵 Audio recording

1 Touch the PLAY button.

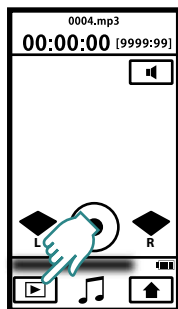

The camcorder turns to play back mode.

2 Select audio to play back.

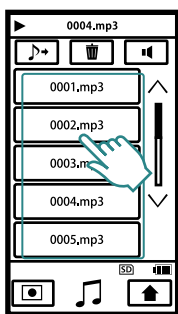

Touch ^ / v to move to another page.

To the recorded audio files, serial numbers 0001-9999 will be given.

3 Play back the audio.

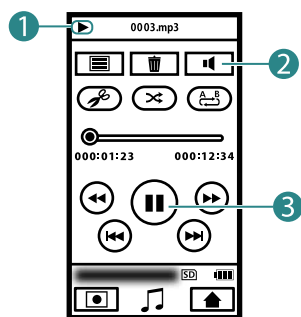

Operation modes (1)

▶ Playback

⏸ Pause

⏭ Forward search

⏮ Reverse search

Adjust the volume (2)

Touch +/- to make adjustments and touch ✕ to quit.

Operation buttons (3)

▶ Playback

⏸ Pause

⏭ Advances to the next audio

⏮ Returns to the beginning of the Audio currently playing

⏭ Forward search

⏮ Reverse search

🔀 Changes the playback order (Random Playback)

Touch ☰ to return to the audio index screen.

Repeated Audio Playback of a Part (A-B Repeat)

Preparation: 🎵 Audio playback

1 Play back the audio, then touch  at the starting/end points.

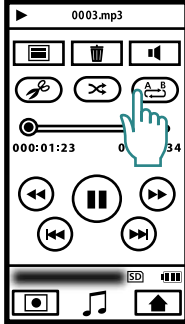

With every touch, the setting toggles as shown below.

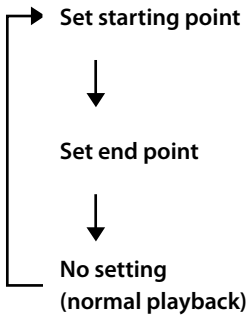

NOTE

- A-B repeat is possible only within one scene.
- The setting is canceled if Stop or Random Playback is selected after the end point is set.

Play External Audio Files

You can play audio files (MP3) recorded with other devices such as computer.

Preparation: 🎵 Audio playback

1 Touch 🎵➡ on the audio index screen.

2 Select audio to play back.

Touch 🎧 to return to the normal audio playback.

NOTE

- You can create up to 3 levels of folders under [MUSIC].
- You can create up to 50 subfolders per folder.
- You can create up to 999 files per folder.
- Display of tags and the Album Art are not supported.

- Folders and files with double-byte characters (such as Japanese) cannot be played.
- Folders and files with more than 8 single-byte characters cannot be played.
(You cannot edit file name with the camcorder. Use a computer and other devices to edit file names.)
- You cannot delete external audio files with the camcorder.
- You can play only stereo audio files.
- You can play audio at 44.1 kHz and 48 kHz. (Playback of not all the files is guaranteed.)
- You cannot play back Mpeg2 and Mpeg2.5 audio files.

Structure of folders and files

Using computer or other devices, copy the audio to play back (folders and files) to an SD card under [MUSIC] folder.

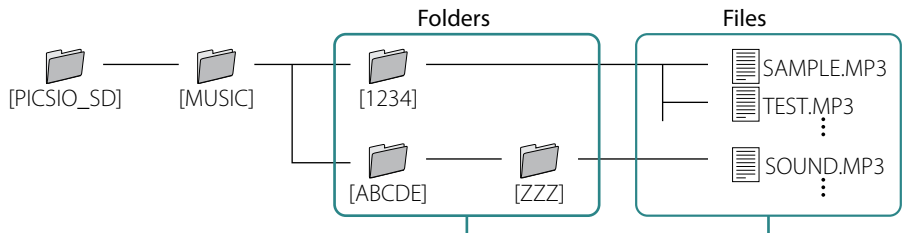

The name is arbitrary (8 or less single-byte alphanumeric characters).

The name is arbitrary (8 or less single-byte alphanumeric characters).
The extension is [MP3].

Delete Audio Files (GC-WP10 only)

Preparation: 🎵 Audio playback

1 Touch 🗑️.

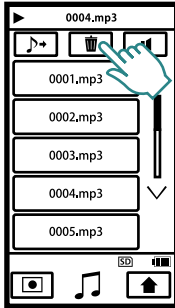

2 Touch the audio file to delete.

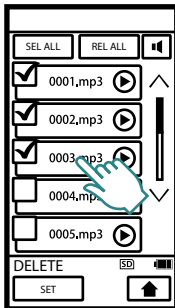

A check mark appears on the selected audio.

If you touch the audio with a check mark, the selection is cancelled.

You can select all the audio files by touching [SEL ALL].

You can cancel all the selection by touching [REL ALL].

You can confirm the audio to play back by touching ▶️ (Confirm Playback).

3 Touch [SET].

4 Touch [DELETE] when the confirmation message appears.

NOTE

- You can delete the files by touching 🗑️ during audio playback.
- You cannot delete external audio files.

Copying a Part in the Audio (GC-WP10 only)

Preparation: 🎵 Audio playback

- 1 Play back the audio file, then touch .

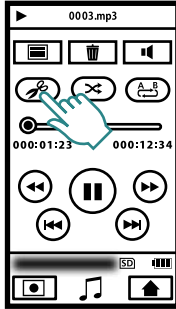

- 2 Pause playback at the starting point and touch **A**.

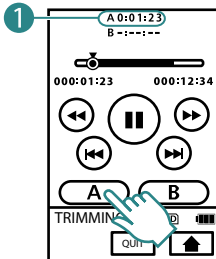

Copy starting point (1).

- 3 Resume playback, pause at the end point and touch **B**.

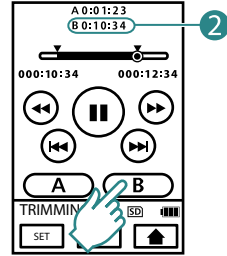

Copy end point (2).

- 4 Touch [SET].

- 5 Touch [YES] when the confirmation message appears.

When copying finishes, the copied file is added to the index screen.

NOTE

- The starting and end points of the copied audio may not exactly match the selected points.

Make a Backup on Computer

Preparation: Turn on the camcorder and the computer.

You can save the recorded videos, still images or audio files on a computer.

1 Connect the camcorder to a computer.

GC-WP10

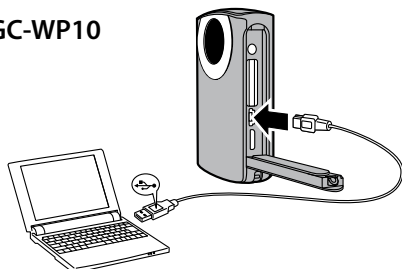

See page 7 for the position of the USB connector on GC-FM2.

If the camcorder is not charged, it will not turn on when connected to the computer.

2 Windows: Double-click [PICSIO_SD] in [Computer] (or [My Computer]).

Mac: Double-click [PICSIO_SD] on the desktop.

3 Copy video/still image/audio files from the [DCIM] folder.

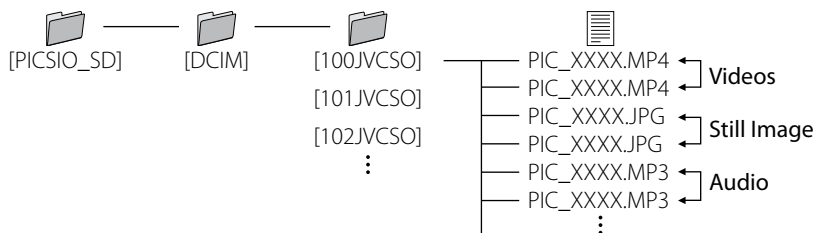

To disconnect the camcorder from a computer (Windows)

- 1 Click the  icon in the task tray on the computer screen. The [Safely Remove Hardware] window appears.
- 2 Select [USB Mass Storage Device] and then click [Stop].

To disconnect the camcorder from a computer (Mac)

Drag and drop [PICSIO_SD] and [PICSIO_APP] on the desktop to the Trash. When they disappear from the desktop, disconnect the USB cable.

Using the Supplied Software

For Windows PC Users

You can edit videos and still images, or transfer them to iPod or the sharing site (YouTube, etc.) using the supplied software. (Please use another software for DVD or BD creation and burning.)

Right click [Computer] (or [My Computer]) in the Start Menu, then select [Properties] and confirm the following items.

For Windows Vista/Windows 7

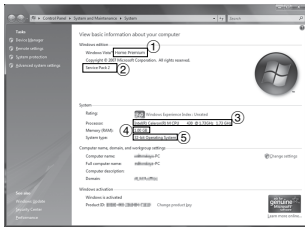

① **Windows Vista:** Home Basic or Home Premium

(Pre-installed edition only for both)

Windows 7: Home Premium

(Pre-installed edition only)

② **Service Pack 2** (Windows Vista only)

③ **Processor:**

Intel Core 2 Duo CPU 2 GHz or higher

Intel Core 2 Duo CPU 3 GHz or higher recommended

Intel Core 2 Quad CPU 2 GHz or higher recommended

④ **Memory:** 2 GB or more

⑤ **System type:** 32 bit/64 bit

For Windows XP

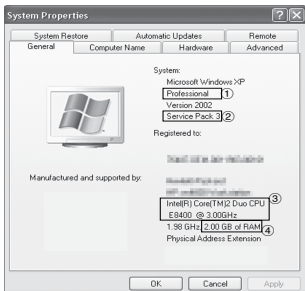

① **Windows XP:** Home Edition or Professional

(Pre-installed edition only for both)

② **Service Pack 3**

③ **Processor:**

Intel Core 2 Duo CPU 2 GHz or higher

Intel Core 2 Duo CPU 3 GHz or higher recommended

Intel Core 2 Quad CPU 2 GHz or higher recommended

④ **Memory:** 2 GB or more

Other Conditions

Graphic: Intel 945 or later, NVIDIA Geforce 6000 series or later, ATI Radeon 9600 or later

NOTE

- The system configuration described above is required in order to use the supplied software.
- Microsoft .NET Framework 3.5sp1 must be installed on your computer.
- The camcorder is compatible to the graphic cards equipped with the playback support function of H.264 video.

- To enable MultiTouch control, Windows 7 and the display compatible to MultiTouch is required.
- For details, consult with the manufacturer of your computer.
- For details on hardware requirements and customer support information, refer to the following web site.
<http://loilo.tv/product/15>

To start the supplied software

Preparation:

- Turn on the camcorder and the computer.
- Connect the camcorder to the computer. (P.39)

1 [Auto Play] window appears.

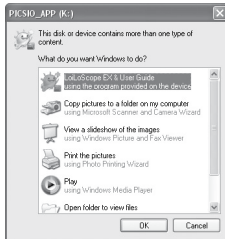

If [Auto Play] window does not appear, double-click the [PICSIO_APP] icon in [My Computer] then double-click the LoiLoScope EX (LoiLoScopeEX.exe).

2 Select [LoiLoScope EX] and click [OK].

If [LoiLoScope EX] does not appear in the [Auto Play] window; select [Open folder to view files], click [OK] and double-click the LoiLoScope EX (LoiLoScopeEX.exe) icon in the window.

NOTE

- For details about operations in LoiLoScope EX, see its Help.

For Mac Computer Users

You can import files from this unit to a computer using Apple's iMovie '09 (video) or iPhoto (still image).

To verify the system requirements, select "About This Mac" from the Apple menu. You can determine the operating system version, processor and amount of memory.

- For the latest information on iMovie or iPhoto, refer to the Apple website.
- For details on how to use iMovie or iPhoto, refer to the help file of the respective software.
- There is no guarantee that the operations will work with all computer environments.

Using an Eye-Fi Card

What is Eye-Fi?

Eye-Fi is an SD memory card with wireless LAN function.

Using an Eye-Fi card, you can transfer videos and still images to a computer or the web. (An Internet accessible environment and a wireless LAN router are separately required.)

Use of Eye-Fi card may be illegal and prohibited in countries and regions where it has not been approved by competent authorities. Please contact Eye-Fi support for the details of approved countries and regions.

Types of cards

Product name	Video Transfer	Still Image Transfer
Eye-Fi Home/ Eye-Fi Share/ Eye-Fi Geo	–	○
Eye-Fi Share Video/ Eye-Fi Explore Video/ Eye-Fi Pro/ Eye-Fi Connect X2/ Eye-Fi Geo X2/ Eye-Fi Explore X2/ Eye-Fi Pro X2	○	○

Audio files cannot be transferred.

To use the Eye-Fi card

1 Make settings on the Eye-Fi card with Eye-Fi Center.

For how to install and operate the Eye-Fi Center, refer to its instruction manual.

2 Set the [Eye-Fi SETTING] to [ON] in the Basic Settings. (P.45)

- When the [Eye-Fi SETTING] is set to [ON] recorded videos and still images are automatically transferred.
(The files already transferred earlier are not transferred again.)
- To abort Eye-Fi transfer, turn off the camcorder or set the [Eye-Fi SETTING] to [OFF] in the Basic Settings.
- To transfer selected videos and still images, see page 43.
The Eye-Fi Center with the default setting transfers all videos/still images.
Change the settings for the Eye-Fi Center beforehand to transfer selected videos/still images.

NOTE

- You cannot transfer files during the recording mode, editing and formatting of the card.
- You cannot transfer video files larger than 2 GB. (as of July, 2010)
- Depending on the connection conditions, transfer may be interrupted or take time long due to passing the Eye-Fi server, even if it is displayed that the transfer has been completed.

- We recommend using the AC adapter (optional: AC-V10LU/JVC) when transferring files of large size.
- If it doesn't operate properly, first confirm that the settings of the Eye-Fi card are correct and try the data transfer using other equipment.
- Do not use the camcorder in places where wireless use is prohibited such as on a plane.
- For the latest information on the Eye-Fi card, refer to the website of Eye-Fi, Inc. (<http://www.eye.fi/>).

To transfer selected videos/still images

Preparation: Video/ Still image playback

1 Touch .

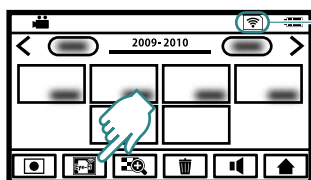

- Eye-Fi Setting [OFF]
- Eye-Fi Setting [ON]
- Ready for Transfer from the Eye-Fi card
- Transferring from the Eye-Fi card (animated)

2 Touch the video/still image to transfer.

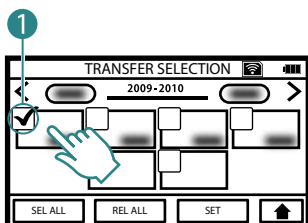

A check mark(1) appears on the selected video/still image.

If you touch the video/still image with a check mark, the selection is cancelled.

Touch [SEL ALL] to select all the video/still image files.

Touch [REL ALL] to cancel all the selection.

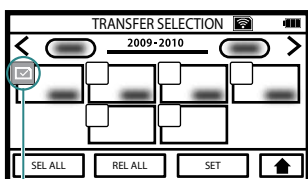

(2) appears on the transferred files.

3 Touch [SET].

4 Touch [SAVE] when the confirmation message appears.

Using the Menu

You can make various settings using the menu.

Basic Settings

- 1 Touch  and display the Top Menu.

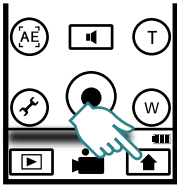

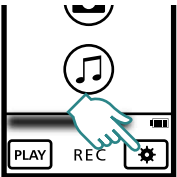

- 2 Touch the Basic Settings button.

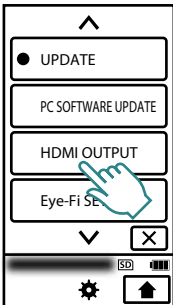

The Basic Settings screen appears.

- 3 Touch the desired settings.



Touch   to move to another page.

- 4 Touch the item to set.

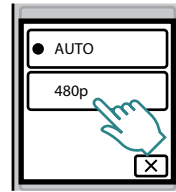

Touch  to return to the previous screen.

Touch  to quit the setting.

Menu Settings (during Video/Still Image recording)

- 1 Video recording: Touch the Menu Settings button.

Still image recording: Touch the Effect button. (P.9)

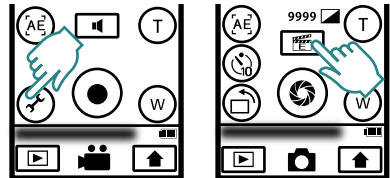

The Menu Settings screen appears.

- 2 Touch the item to set.

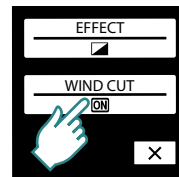

With every touch, the setting will change.

Touch  to quit the setting.

Basic Settings

- indicates the default setting.

CLOCK ADJUST

CLOCK SETTING:

Resets the current time or changes the settings.

AREA SETTING:

Sets to the local time when using this unit abroad simply by selecting the destination.

DST SETTING:

Sets whether daylight saving time is observed at the travel destination.

LANGUAGE

The language on the display can be changed.

FORMAT SD CARD

FILE:

Deletes all files on the SD card.

FILE & MGMT NUMBER:

Deletes all the files on the SD card and resets the folder and file numbers.

- Not available for selection when no SD card is inserted.

UPDATE

PC SOFTWARE UPDATE

Updates the functions of this unit and built-in software for PC to the latest versions. For details, refer to the JVC website. (Details will be available only after the [UPDATE] and [PC SOFTWARE UPDATE] are ready.)

HDMI OUTPUT

- **A** AUTO:

It is recommended to select [AUTO] normally.

P 480p:

Select this when the video is not output in [AUTO] correctly.

Eye-Fi SETTING

- OFF** OFF:

Does not transfer the files.

- **ON** ON:

Transfers video/still image files automatically.

TOUCH SCREEN ADJUST

Adjust if the reactive area of the screen is misaligned with the touched area.

Menu Settings (during Video/Still Image recording)

EFFECT

- **OFF** OFF:

No effect.

B/W MONOTONE:

Records in black and white.

SEPIA:

Gives images a brownish tint like old photographs.

SOLARIZATION:

Records with some of the tones reversed.

NEGATIVE:

Reverses the brightness.

CLASSIC FILM: (Video mode only)

Skips frames to give images of the effect of an old video.

STROBE: (Video mode only)

Enables the image to look like a series of consecutive snapshots by skipping frames.

WIND CUT (Video mode only)

- **OFF** OFF:

Does not reduce the noise.

ON ON:

Reduces the noise caused by wind.

Troubleshooting

Before requesting service, consult the following chart. If the solutions indicated in the chart do not solve the problem, consult your nearest JVC dealer or JVC service center for instructions.

Refer also to the FAQ section on JVC's website (<http://www.jvc.com>).

■ The following phenomena are not malfunctions.

- LCD monitor momentarily becomes red or black when sunlight is recorded.
- Black spots, or red, green, or blue spots appear on the LCD monitor.
(The LCD monitor contains 99.99% effective pixels, but 0.01% or fewer pixels may be ineffective.)

The camera is a microcomputer-controlled device. Electrostatic discharge, external noise and interference (from a TV, a radio, etc.) might prevent it from functioning properly. **In such a case, reset the camcorder by pressing and holding the Power button for more than 10 seconds. If you reset the camcorder, reset the clock. (P.18)**

Troubles

	Trouble	Action	Page
Battery	Unable to turn on the power.	• Recharge the battery.	14
		• When the battery level is extremely low, the camcorder does not turn on until it is charged even if it is connected to the computer or AC adapter.	15
	Unable to charge the battery.	• Check the remaining battery power. (When the battery is fully charged, the lamp does not flash.)	14, 15
		• If you were charging the battery in a low or high temperature environment, charge in an environment within the allowable operating temperature. (Charging may stop in an environment out of the allowable operating temperature for the protection of the battery.)	–
		• When charging using the computer, turn on the computer.	–
	The battery depletes even when connected to AC adapter.	• Please use a JVC AC adapter (optional: AC-V10LU). (Depending on the AC adapter you use, battery will deplete due to insufficient power supply from the adapter.)	15
	Charging takes a long time.	• Please use a JVC AC adapter (optional: AC-V10LU).	15

	Trouble	Action	Page
During recording	Recording video/still image/audio cannot be performed.	<ul style="list-style-type: none"> • Check the video/still image/audio recording mode. • Select recording mode. 	20, 33 20
	Recording stops automatically.	<ul style="list-style-type: none"> • Turn off the power, wait for a while, and start recording again. (This unit stops automatically to protect the circuit when the temperature rises.) • Recording stops automatically as it cannot be performed for 12 or more consecutive hours according to specifications. 	– –
	The continuous shooting speed of still images is slow.	<ul style="list-style-type: none"> • The continuous shooting speed will drop if this function is used repeatedly. • Continuous shooting speed may drop depending on the SD card or under certain recording conditions. 	– –
During playback	Sound or video is interrupted.	<ul style="list-style-type: none"> • Sometimes playback is interrupted at the connecting section between two scenes. This is not a malfunction. 	–
	The same image is displayed for a long time during video playback, or motion is choppy.	<ul style="list-style-type: none"> • Replace the SD card with a new one. Perform [FORMAT SD CARD] in Basic Settings. (All data will be deleted.) 	–
	Image is stretched up and down on the TV.	<ul style="list-style-type: none"> • On the TV with aspect ratio of 4:3, images are projected vertically. 	–
	When connecting to the HDMI mini cable, the image does not appear on the TV properly.	<ul style="list-style-type: none"> • Disconnect the HDMI mini cable and connect it again. • Turn off and on this unit again. (The image or sound may not appear on the TV properly depending on the TV connected.) 	– 32
Computer	Unable to copy files to the computer's HDD.	<ul style="list-style-type: none"> • Connect the USB cable correctly. • Before copying files, make sure that enough free space is left in the computer's hard disk (HDD). 	39 –
	The computer cannot recognize the SDXC card.	<ul style="list-style-type: none"> • Confirm and upgrade the OS of your computer. 	13

	Trouble	Action	Page
Other Problems	The LCD monitor is difficult to see.	<ul style="list-style-type: none"> The LCD monitor may not be clearly visible if used in bright areas such as under direct sunlight. 	–
	A band of bright light appears on the LCD monitor.	<ul style="list-style-type: none"> Change the direction of this unit to prevent the light source from coming into view. (A band of bright light may appear when there is a bright light source near this unit, but this is not a malfunction.) 	–
	The unit operates slowly when switching between video mode and still image mode, or when switching the power on or off.	<ul style="list-style-type: none"> It is recommended that you copy all video/still image/audio files onto your computer, and erase the files from this unit. (If there are many recorded files on this unit, it takes time for the unit to respond.) 	30, 39
	The unit heats up.	<ul style="list-style-type: none"> This is not a malfunction. (This unit may become warm when used for a long time.) 	–

Warning Indications

	Indication	Action	Page
	SET DATE/TIME!	<ul style="list-style-type: none"> Charge the battery before setting the clock. 	18
	FORMAT ERROR!	<ul style="list-style-type: none"> Check the operating procedure, and perform once again. Turn off this unit, and turn it on again. 	45 –
	MEMORY CARD ERROR!	<ul style="list-style-type: none"> Turn off this unit, and turn it on again. Re-insert the SD card. Remove any dirt from the SD card terminals. If the above does not solve the problem, back up your files and execute [FORMAT SD CARD] in the Basic Settings. (All data will be deleted.) 	– 12 – 45
	NOT FORMATTED	<ul style="list-style-type: none"> Select [OK] then select [YES] on the [DO YOU WANT TO FORMAT MEMORY CARD?] screen. (All data will be deleted.) 	–
	RECORDING FAILURE	<ul style="list-style-type: none"> Turn off this unit, and turn it on again. 	–
	UNSUPPORTED SCENE (FILE)!	<ul style="list-style-type: none"> Use files recorded with this unit. (Files recorded with other devices than this unit may not be playable.) 	–
	CHECK CARD'S WRITE PROTECTION SWITCH	<ul style="list-style-type: none"> Release the write protection switch of the SD card. 	–
	INSUFFICIENT AVAILABLE SPACE	<ul style="list-style-type: none"> Delete files, or move files to a computer or other devices. Replace the SD card with a new one. 	– –
	FILE QUANTITY LIMIT EXCEEDED	<ol style="list-style-type: none"> Move the files or folders to a computer or other device. (Back up your files.) 	39
	NUMBER OF FOLDERS OVERFLOW	<ol style="list-style-type: none"> Select [FILE & MGMT NUMBR] in [FORMAT SD CARD] of the Basic Settings. (All data on the SD card will be deleted.) 	45

Specifications

Camera

Power consumption

2.2 W

Dimensions (W × H × D)

GC-WP10:

60 mm × 101 mm × 25 mm
(2-3/8" × 4" × 1")

GC-FM2 :

53 mm × 102 mm × 22 mm
(2-1/8" × 4-1/16" × 7/8")

Weight

GC-WP10:

147 g (0.33 lbs)
152 g (0.34 lbs) (Including hand
strap and SD card)

GC-FM2:

113 g (0.25 lbs)
115 g (0.26 lbs) (Including SD card)

Operating environment

Operating temperature:

0 °C to 40 °C (32 °F to 104 °F)

Storage temperature:

-20 °C to 50 °C (-4 °F to 122 °F)

Operating humidity: 35 % to 80 %

Image pickup device

1/3.2" 5,130,000 pixels (progressive CMOS)

Recording area (Video)

(HD 1080)	2,090,000 pixels
(HD 720)	3,400,000 pixels
(QHD, iFrame)	2,090,000 pixels

Recording area (Still Image)

(Portrait)	5,030,000 pixels
(Landscape)	2,760,000 pixels

Lens

F2.8, f=3.9 mm

35 mm conversion:

(HD 1080) f=43.6 mm

(HD 720) f=34.2 mm

(QHD, iFrame) f=43.6 mm

(Still image: Portrait) f=29.8 mm

(Still image: Landscape) f=40.3 mm

LCD monitor

3.0" diagonally measured,
LCD panel/TFT active matrix system

Zoom

Digital zoom: Up to 4x

Video recording format

Video: Mpeg-4 AVC/H.264

Audio: AAC 48 kHz 16 bit

256 kbps (2ch)

GC-WP10: stereo sound

GC-FM2: monaural sound

Still image recording format

JPEG standard

Continuous shooting speed:

approx. 1.5 shots/second

Audio recording format (GC-WP10 only)

Mpeg-1 Audio Layer 3 standard

Playable software:

Windows: LoiLoScope EX (supplied)

Mac: QuickTime

Recording media

SD/SDHC/SDXC card (commercially available)

Eye-Fi card (commercially available)

Connectors

HDMI

HDMI® mini connector

AV output

Video output: 1.0 V (p-p), 75 Ω

Audio output:

GC-WP10: 300 mV (rms), 220 Ω

GC-FM2 : 300 mV (rms), 1 kΩ

Headphones output (GC-WP10 only).

Also serves as AV output.)

USB

GC-WP10:

Mini USB Type B, USB 2.0 compliant

GC-FM2 :

USB Type A, USB 2.0 compliant

Waterproof (GC-WP10 only)

Condition

Depth 3 m (10 ft)/30 minutes

Operation

Power on/off

Video recording/stop

Still image shooting

- The specifications and appearance of this product are subject to changes for further improvement without prior notice.

Approximate Time/Number of Recording

Approximate Video Recording Time

Type	Quality	SDHC Card		SDXC Card
		4 GB	16 GB	64 GB
HD 1080	1920 × 1080 30 frames/second (Average 12 Mbps VBR)	40 m	2 h 50 m	11 h 40 m
HD 720	1280 × 720 60 frames/second (Average 12 Mbps VBR)	40 m	2 h 50 m	11 h 40 m
iFrame	960 × 540 30 frames/second (Average 24 Mbps VBR)	20 m	1 h 20 m	5 h 50 m
QHD	960 × 540 30 frames/second (Average 5 Mbps VBR)	1 h 40 m	6 h 40 m	27 h 30 m

- The above recording time is approximate. The actual recording time may shorten depending on the shooting environment.

Approximate Number of Still Images (Unit: Number of Shots)

Recording mode (Image size)	SD Card		SDHC Card			SDXC Card
	1 GB	2 GB	4 GB	8 GB	32 GB	64 GB
Portrait (2592 × 1944)	300	600	1300	2700	9999	9999
Landscape (1440 × 1920)	600	1200	2300	4700	9999	9999

- The above number of shots is approximate. The number of recordable still images may be less depending on the scene to record.

Approximate Audio Recording Time (GC-WP10 only)

Sound quality	SDHC Card		SDXC Card
	4 GB	16 GB	64 GB
MP3 44.1 kHz 16 bit Stereo (128 kbps CBR)	66 h 40 m	135 h 40 m	1093 h

- The above recording time is approximate.

Approximate Recording Time (Using Battery)

Battery	Approximate Charging Time	Actual Recording Time	Continuous Recording Time
Built-in Battery	When using the computer: 3 h 00 m When using the AC adapter: 2 h 00 m	40 m	1 h 20 m

- The actual recording time may be shorter if zooming is used or if recording is stopped repeatedly.
- When the battery life is reached, the recording time becomes shorter even if the battery is fully charged.

Customer Support Information

Use of this software is authorized according to the terms of the software license.

JVC

When contacting the nearest JVC office or agency in your country (refer to the JVC Worldwide Service Network at <http://www.jvc-victor.co.jp/english/worldmap/index.html>) about this software, please have the following information ready.

- Product Name, Model, Problem, Error Message
- PC (Manufacturer, Model (Desktop/Laptop), CPU, OS, Memory (MB/GB), Available Hard Disk Space (GB))

Please note that it may take some time to respond to your questions, depending on their subject matter.

JVC cannot answer questions regarding basic operation of your PC, or questions regarding specifications or performance of the OS, other applications or drivers.

LoiLo inc

Homepage: <http://loilo.tv/product/15>

Index

A

- A-B repeat29, 35
- Audio mode 33

B

- Basic settings 45
- Battery indicator 15

C

- Charging 14
- Clock adjust 18
- Clock setting 18
- Computer 39
- Copy31, 38

D

- Delete30, 37

E

- Effect 45
- External audio file 36
- Eye-Fi card 42

F

- Face priority AE 23
- Folder number 36

I

- Index screen/thumbnail display 10

M

- Menu settings 45

O

- Operation mode28, 34

R

- Recording in water 25
- Recording mode 20
- Recording time/number of recordable still images 50

S

- SCREEN LOCK button 26
- SD card 12
- Self timer 22
- Size of still image 22
- Still image mode 20

T

- Time-lapse recording 24
- Touch AE 23
- Trimming 31

V

- Video image quality 21
- Video mode 20
- Viewing on TV 32

JVC