

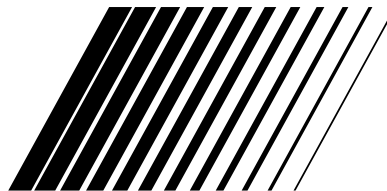

JVC



VIDEO CASSETTE RECORDER

VIDEO PŘEHRÁVAČ

MAGNETOWID KASET VIDEO

HR-E639EE (Hi-Fi)
(Vysoká věrnost reprodukce - Hi-Fi)
(Hi-Fi)

HR-E539EE (Monaural)
(Monofonní)
(Monofoniczny)

ENGLISH

ČESKY

POLSKI

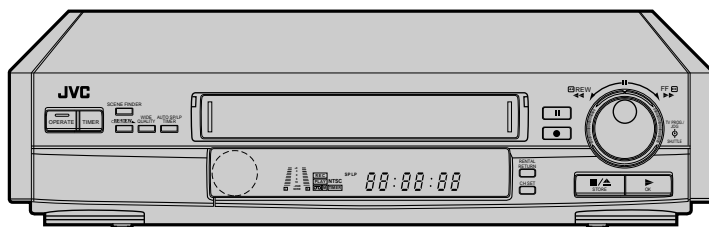

Hi-Fi

VHS
PAL NTSC

The recorder illustrations appearing in this instruction manual are of the HR-E639EE.

Na ilustracích v tomto návodu je zobrazen videorekordér HR-E639EE.

Ilustracje odtwarzacza przedstawione w niniejszej instrukcji dotyczą HR-E639EE.

INSTRUCTIONS
POKYNY
INSTRUKCJA



Safety Precautions

The rating plate and the safety caution are on the rear of the unit.

WARNING: DANGEROUS VOLTAGE INSIDE

WARNING: TO PREVENT FIRE OR SHOCK HAZARD, DO NOT EXPOSE THIS UNIT TO RAIN OR MOISTURE.

CAUTION

- When you are not using the recorder for a long period of time, it is recommended that you disconnect the power cord from the mains outlet.
- Dangerous voltage inside. Refer internal servicing to qualified service personnel. To prevent electric shock or fire hazard, remove the power cord from the mains outlet prior to connecting or disconnecting any signal lead or aerial.

ATTENTION

1. This recorder can also receive SECAM colour television signals for recording and playback.
2. Recordings made of SECAM television signals produce monochrome pictures if played back on another video recorder of SECAM standard, or do not produce normal colour pictures if played back on another video recorder of PAL standard.
3. SECAM prerecorded cassettes or recordings made with a SECAM video recorder produce monochrome pictures when played back with this recorder.

POWER SYSTEM

This set operates on voltage of AC110 – 240 V \sim (Rating), AC90 – 260 V \sim (Operating), 50/60 Hz with automatic switching.

IMPORTANT

- Please read the various precautions on this page and page 33 before installing or operating the recorder.
- It should be noted that it may be unlawful to re-record pre-recorded tapes, records, or discs without the consent of the owner of copyright in the sound or video recording, broadcast or cable programme and in any literary, dramatic, musical, or artistic work embodied therein.

The OPERATE button does not completely shut off mains power from the unit, but switches operating current on and off.

Video tapes recorded with this video recorder in the LP (Long Play) or EP (Extended Play) mode cannot be played back on a single-speed video recorder.



- Only cassettes marked "VHS" can be used with this videorecorder.
- HQ VHS is compatible with existing VHS equipment.

Contents

SAFETY FIRST	2	TIMER RECORDING	20
Safety Precautions	2	Timer Programming	20
INSTALLING YOUR NEW RECORDER	3	Check And Cancel Programmes	21
Basic Connections	3	Auto SP/LP Timer	21
Tune The TV To Your Video Recorder	4	EDITING	22
Select Television System	4	Edit To Or From Another Video Recorder	22
INITIAL SETTINGS	5	Edit From A Camcorder	23
On-Screen Displays	5	INFORMATION ON MULTI-SYSTEM COMPATIBILITY	24
Tuner Set	6	REMOTE CONTROL	26
Clock Set	9	Multi-Brand Remote Control	26
PLAYBACK	10	TROUBLESHOOTING	27
Basic Playback	10	QUESTIONS AND ANSWERS	29
Playback Features	11	INDEX	30
RECORDING	16	SPECIFICATIONS	33
Basic Recording	16		
Recording Features	17		
B.E.S.T. Picture System	18		

Basic Connections

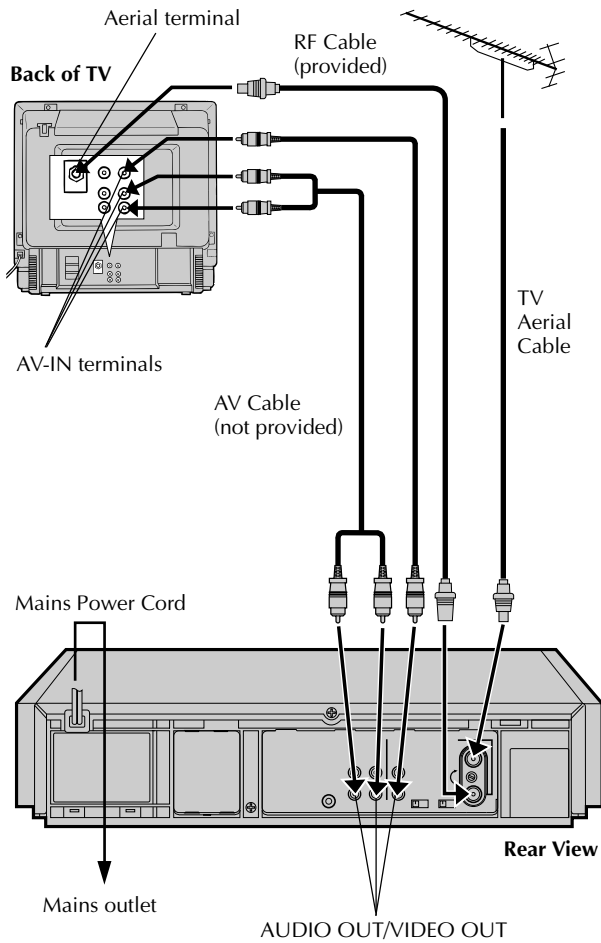

For HR-E539EE Owners:
If your TV has AUDIO IN L and R connectors, connect the recorder to the L connector.

It's essential that your video recorder be properly connected. Follow these steps carefully. THESE STEPS MUST BE COMPLETED BEFORE ANY VIDEO OPERATION CAN BE PERFORMED.

- 1 CHECK CONTENTS**
Make sure the package contains all of the accessories listed in "Specifications" (pg. 33).
- 2 SITUATE RECORDER**
Place the recorder on a stable, horizontal surface.
- 3 CONNECT RECORDER TO TV**
The connection method you use depends on the type of TV you have.
 - RF CONNECTION**
 - To Connect To A TV With NO AV Input Terminals . . .
 - a- Disconnect the TV aerial cable from the TV.
 - b- Connect the TV aerial cable to the ANT. IN jack on the rear panel of the recorder.
 - c- Connect the provided RF cable between the RF OUT jack on the rear panel of the recorder and the TV's aerial terminal.
 - AV CONNECTION**
 - To Connect To A TV With AV Input Terminals . . .
 - a- Connect the aerial, recorder and TV as per "RF CONNECTION".
 - b- Connect an optional AV cable between the AUDIO OUT and VIDEO OUT connectors on the rear panel of the recorder and the TV's AV-IN terminals .
 - 4 CONNECT RECORDER TO MAINS**
Plug the end of the mains power cord into a mains outlet.

ENGLISH



Select Television System

Major countries	Colour TV broadcast system	Switch position
China, Mongolia, Rumania	PAL D/K	K
Bulgaria, Czech Rep., Slovakia, Hungary, Poland, Russia	SECAM D/K	
Austria, Denmark, Finland, Holland, Italy, Norway, Spain, Switzerland, Sweden, Germany	PAL B/G	G
Egypt	SECAM B/G	

1 SET SYSTEM SWITCH

Set to the appropriate position depending on your TV system. (Refer to the chart on the left.)

NOTES:

- If no colours appear on the screen when using a multi-system television with its system select switch set to AUTO, change the switch position to correspond to the recorder's RF system select switch (G or K).
- For more information on multi-system compatibility. ☞ p.24

Back of recorder

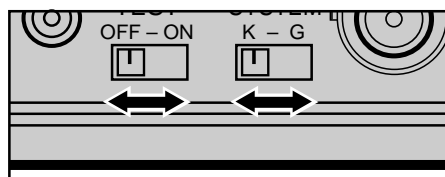

Tune The TV To Your Video Recorder

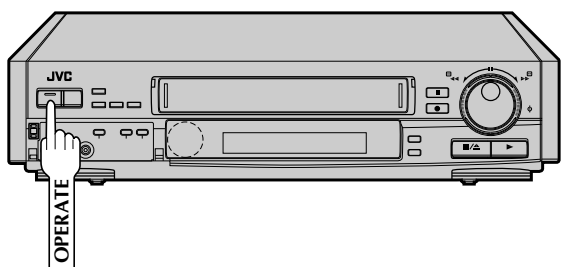

The video recorder sends picture and sound signals via the RF connecting cable to your TV on UHF channel 36.

1 TURN ON THE RECORDER

Press **OPERATE**.

2 SELECT OUTPUT MODE

Set the **TEST** switch on the back of the recorder to ON.

3 SET TV CHANNEL

Set your TV to the video channel (UHF channel 36). Two white bars appear on screen vertically.

- Tune the TV until the bars are as clear as they can be.
- Your TV should be set to the channel designated for use with a video recorder, or to a spare channel if there is not a specified video channel on your TV.

4 RESET OUTPUT MODE

Return the **TEST** switch to OFF.

NOTES:

- If CH36 is occupied by a local station, adjust the RF output channel adjustment screw to use another channel between CH32 and CH40 instead.
- If some interference noise is continually seen on the screen, consult your JVC dealer.



On-Screen Displays

Turn on the TV and select the VIDEO channel (or AV mode).

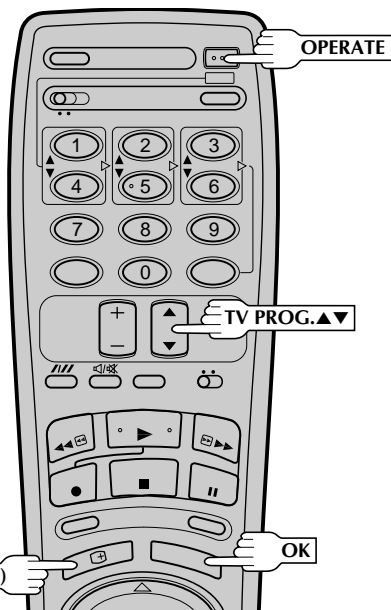
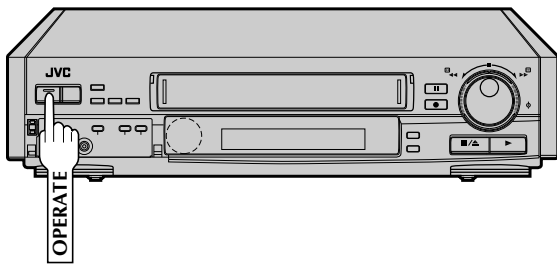

You can choose whether or not to have various operational indicators appear on screen, by setting this function ON or OFF. Messages appear in the language you select. Use the buttons on the remote control for this procedure.

1 TURN ON THE RECORDER

Press **OPERATE**.

2 SELECT LANGUAGE

Press **OSD** (⊞). The Language screen appears. Place the pointer next to the language of your choice by pressing **TV PROG.▲/▼**, then press **OK** to enter your selection.



3 SELECT MODE

The pointer should already be next to "O.S.D.". If not, press **TV PROG.▲/▼** to place it there.

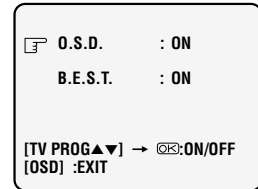

4 ENABLE/DISABLE ON-SCREEN DISPLAY

The default setting is "ON", so if you want on-screen displays, leave the setting as is and go to step 5. If you don't want the displays to appear, press **OK** to set "O.S.D." to "OFF".

5 CLOSE MODE SELECT SCREEN

Press **OSD** (⊞).

The superimposed indication on the TV screen tells you what the recorder is doing.

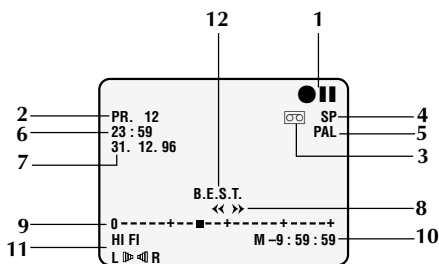

- 1- Operation mode indicators
- 2- Channel position number/Aux. indicator (AUX)
- 3- Cassette loaded mark
- 4- Tape speed SP/LP/EP
- 5- Colour System indicator (⊞ pg. 24)
- 6- Clock display
- 7- Current day/month/year
- 8- Tape direction
- 9- Tape position indicator (⊞ pg. 14)
- 10- Counter display (including Counter Memory indicator)
- 11- Audio mode display [E639EE only]
- 12- B.E.S.T. Picture System indicator

Tuner Set

- Turn on the TV and select the VIDEO channel (or AV mode).
- Be sure to select the AUTO mode by pressing the **COLOUR SYSTEM** button. (☞ pg. 24)

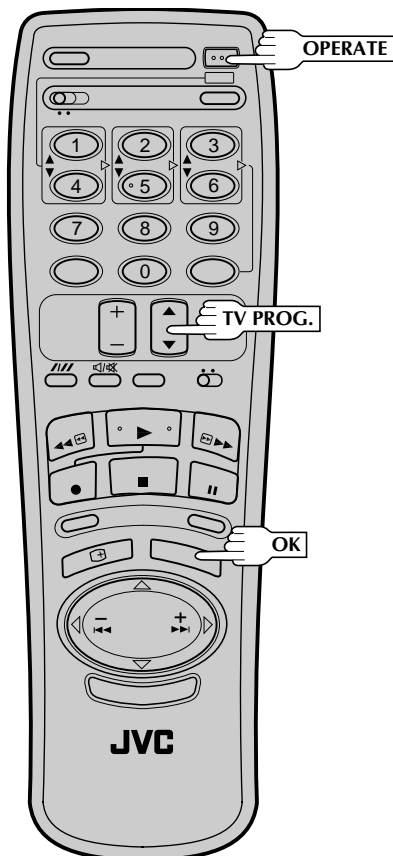
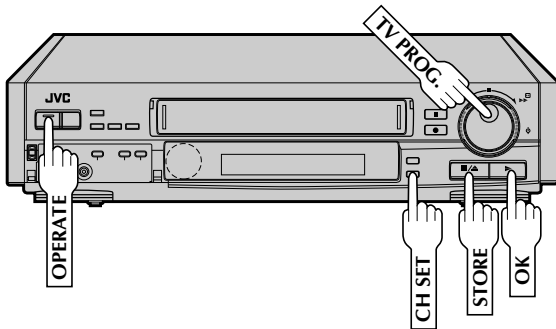

Your recorder needs to memorise all necessary stations in channel positions in order to record TV programmes. Once stored, you can call them up with the **TV PROG.** buttons without going through any vacant channels.

1 TURN ON THE RECORDER

Press **OPERATE**.

2 ACCESS CHANNEL SET MODE SELECT SCREEN

Press and hold **CH SET** for more than 2 seconds. The Channel Set Mode Select screen appears.

3 SELECT MODE

Turn the **TV PROG.** dial to place the pointer next to "SEARCH/STORE", then press **OK**. The Band Select screen appears.

SEARCH/STORE
DELETE
FINE TUNING

[TV PROG.▲▼] → [OK]
[CANCEL] :EXIT

4 SELECT BAND

Turn the **TV PROG.** dial to place the pointer next to the band of your choice, then press **OK** to initiate Auto Channel Search.

BAND SELECT

VHF L
VHF H
UHF

[TV PROG.▲▼] → [OK]
[CH SET] :EXIT

AUTO SEARCH PROCEEDING

PLEASE WAIT

VHF L 00

[CH SET] :EXIT

5 SET DESIRED CHANNEL

The following screen appears when a station is detected. To store the detected station, place the pointer next to "STORE" by turning the **TV PROG.** dial, then press **OK**.

If you don't want to store the station, turn the **TV**

PROG. dial to place the pointer next to "CONTINUE", then press **OK**. Auto Channel Search will start resume.

STORE
CONTINUE

[TV PROG.▲▼] → [OK]
[CH SET] :EXIT

- The blueback screen and the TV picture currently being broadcast appear alternately for 8 seconds each.

NOTES:

- You can also use the **TV PROG.** ▲/▼ button on the remote control instead of the **TV PROG.** dial.
- You can also use the **SHUTTLE** ring on the recorder instead of the **OK** button.

6 SELECT POSITION

- 6** Turn the **TV PROG.** dial until an open position in which you want to store a channel appears, then press **OK**.



7 STORE CHANNEL

- 7** If fine tuning is not necessary, simply press **STORE**. For fine tuning adjustment, turn the **TV PROG.** dial until the picture becomes clearer, then press **STORE**.



- To continue Auto Channel Search, turn the **TV PROG.** dial to select "CONTINUE", then press **OK**. Repeat steps 5 – 7 as necessary.
- To set channels for other bands, turn the **TV PROG.** dial to select "BAND SELECT", then press **OK** to go back to the Band Select screen. Repeat steps 4 – 7.

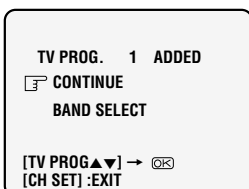

8 RETURN TO NORMAL SCREEN

- 8** Press **CH SET**.

Delete A Stored Channel

1 TURN ON THE RECORDER

Press **OPERATE**.

2 ACCESS CHANNEL SET MODE SELECT SCREEN

Press and hold **CH SET** for more than 2 seconds. The Channel Set Mode Select screen appears.

3 SELECT MODE

Turn the **TV PROG.** dial to place the pointer next to "DELETE", then press **OK**.

4 SELECT CHANNEL

Turn the **TV PROG.** dial until the position number of the channel you wish to delete appears.

- If the on-screen display is hard to read, refer to the recorder's display panel.



5 DELETE CHANNEL

Press **OK** twice. The screen shows the selected channel has been deleted.

- To delete another channel, press **OK** again, then repeat steps 4 – 5.



6 RETURN TO NORMAL SCREEN

Press **CH SET**.

NOTE:

If you skipped a channel by mistake, perform steps 1 – 8 on pages 6 and 7 to re-store it.

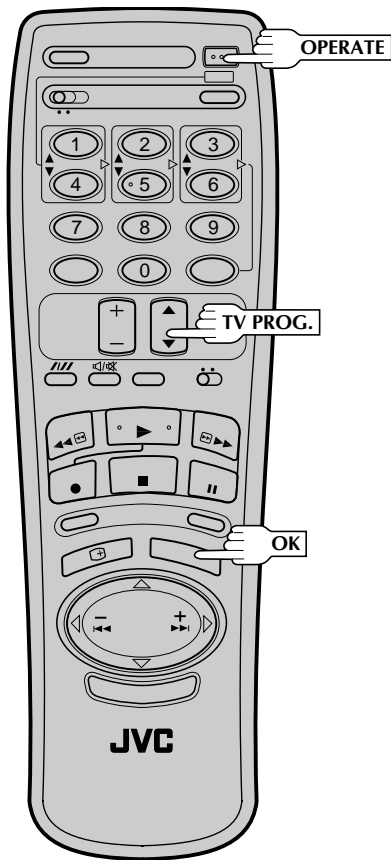
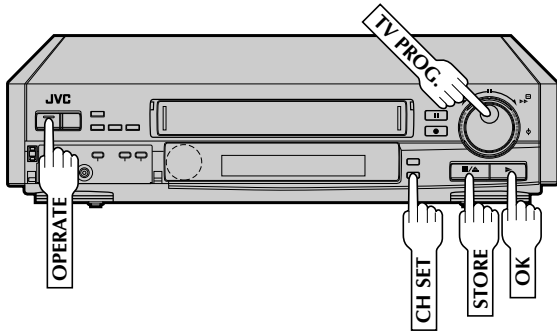

Fine-Tuning Channels Already Stored

1 **TURN ON THE RECORDER**
Press **OPERATE**.

2 **ACCESS CHANNEL SET MODE SELECT SCREEN**
Press and hold **CH SET** for more than 2 seconds. The Channel Set Mode Select screen appears.

3 **SELECT MODE**
Turn the **TV PROG.** dial to place the pointer next to "FINE TUNING", then press **OK**.

4 **SELECT CHANNEL**
Turn the **TV PROG.** dial so that the position number of the channel you want to fine-tune appears, then press **OK**.

SELECT NUMBER
TV PROG. 1

[TV PROG▲▼] → [OK]
[CH SET]:EXIT

5 **PERFORM TUNING**
Turn the **TV PROG.** dial until the picture becomes clearer, then press **STORE**.

- To fine-tune another channel, press **OK** and repeat steps 4 – 5.

TV PROG. 1

[STORE]:STORE
[TV PROG▲]:FINE TUNING +
[TV PROG▼]:FINE TUNING -
[CH SET]:EXIT

6 **RETURN TO NORMAL SCREEN**
Press **CH SET**.

Clock Set

Turn on the TV and select the VIDEO channel (or AV mode).

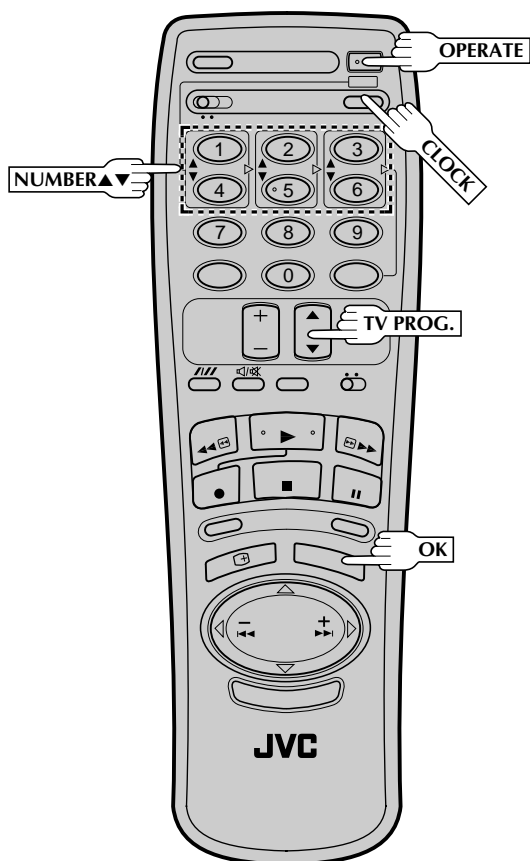
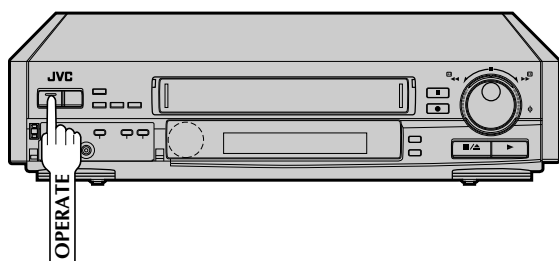

Use the buttons on the remote control for this procedure.

1 TURN ON THE RECORDER

Press **OPERATE**.

2 ACCESS MODE SELECT SCREEN

Press **CLOCK**.

3 SELECT MODE

Press **TV PROG.▲/▼** to place the pointer next to "CLOCK SET", then press **OK**. The Clock Set screen appears.

TIMER PROGRAMMING

☐ **CLOCK SET**

[TV PROG.▲▼] → ☐

[CANCEL] :EXIT

4 SET TIME

Use **NUMBER** key "1(▲)" or "4(▼)" to set the time.

- Press and hold either button to delay or advance the time by 30 minutes.

CLOCK SET

TIME	DATE	YEAR
0:00	01:01	00

[1-6]
[PROG./CLOCK] :EXIT

5 SET DATE

Use **NUMBER** key "2(▲)" or "5(▼)" to set the date.

- Press and hold either button to change the date by 15 days.

6 SET YEAR

Use **NUMBER** key "3(▲)" or "6(▼)" to set the year.

7 RETURN TO NORMAL SCREEN

Press **CLOCK**.

To Make Corrections

Perform steps 1 – 3 to call up the Clock Set screen, use **NUMBER** keys "1" – "6" to make the correction, then press **CLOCK**.

NOTE:

If, in step 7, the year digits are automatically cleared, it is possible that you have input 29th February for a non-leap year. Input the correct data.



Basic Playback

Turn on the TV and select the VIDEO channel (or AV mode).

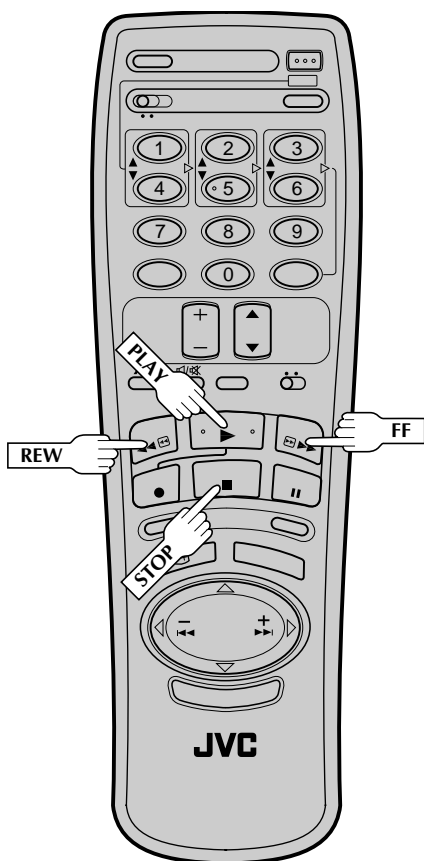
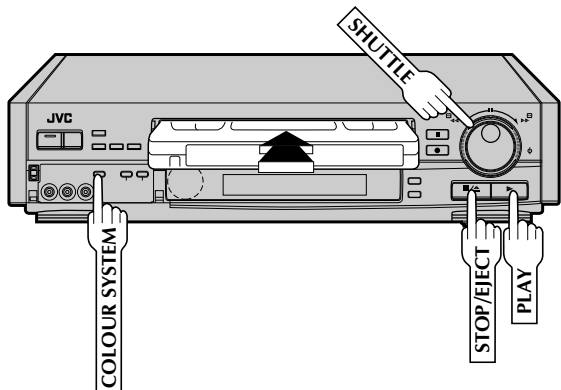

The easiest, most basic operation possible with your video recorder is tape playback. Already-recorded signals on a video tape are read by your video recorder and displayed on your TV just like a TV programme.

1 LOAD A CASSETTE

Make sure the window side is up, the rear label side is facing you and the arrow on the front of the cassette is point toward the recorder. Don't apply too much pressure when inserting.

- The recorder power comes on automatically and the counter is reset to 0:00:00.
- Select the appropriate colour system by pressing the **COLOUR SYSTEM** button. (☞ pg. 24)
- If the record safety tab has been removed, playback begins automatically.

2 FIND PROGRAMME START POINT

If the tape is advanced past the start point, press **REW** or turn the **SHUTTLE** ring to the left and release it. To go forward, press **FF** or turn the **SHUTTLE** ring to the right and release it.

3 START PLAYBACK

Press **PLAY**. "B.E.S.T." appears on screen. (☞ pg. 18)

4 STOP PLAYBACK

Press **STOP** on the remote or **STOP/EJECT** on the recorder's front panel. Then press **STOP/EJECT** to remove the cassette.

Usable cassettes

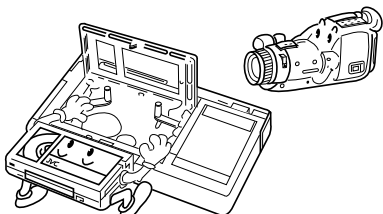

- Compact VHS camcorder recordings can be played on this video recorder. Simply place the recorded cassette into a VHS Cassette Adapter and it can be used just like any full-sized VHS cassette.
- This video recorder can record on regular VHS and Super VHS cassettes. However, it will record and play back regular VHS signals only. It is not possible to play back a recorded Super VHS tape.



Playback Features

Take advantage of special functions possible with the recorder's controls or the remote control.

NOTE:

Refer to the **SHUTTLE** ring illustration below as you read the following procedures.

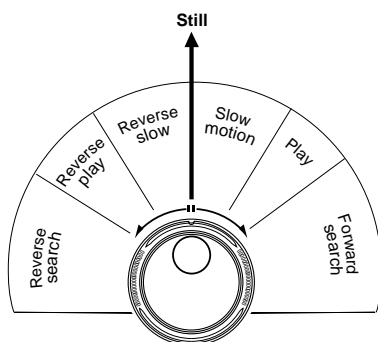

Still Picture/Frame-By-Frame Playback

1

PAUSE DURING PLAYBACK

Press **PAUSE**. If there is vertical jitter, use the **TV PROG.** buttons to correct the picture.

2

ACTIVATE FRAME-BY-FRAME PLAYBACK

Turn the **JOG** dial to the right for forward frame-by-frame playback, or to the left for reverse frame-by-frame playback.

OR

Press **PAUSE**.

OR

Press **PUSH JOG** ◀ or ▶.

To resume normal playback, press **PLAY**.

NOTE:

In the search, still or frame-by-frame playback mode, the picture will be distorted, and there may be a loss of colour.

Slow Motion

1

ACTIVATE SLOW-MOTION PLAYBACK

During playback or still, turn the **SHUTTLE** ring to the right for forward slow motion, or to the left for reverse slow motion (refer to the illustration to the left).

OR

During still picture, press and hold **PAUSE** for 2 seconds, then release. Press and release again to return to still picture.

OR

During still picture, press and hold **PUSH JOG** ◀ or ▶. Release to return to still picture.

To resume normal playback, press **PLAY**.

Variable-Speed Search

1

ACTIVATE VARIABLE-SPEED SEARCH

During playback or still, turn the **SHUTTLE** ring to the right for forward variable-speed search, or to the left for reverse variable-speed search (refer to the illustration to the left).

OR

During playback, press **PUSH JOG** ◀ or ▶.

- The more times you press, the faster the playback picture moves.
- To decrease speed, press the button for the opposite direction.

To resume normal playback, press **PLAY**.

High-Speed Search

1

ACTIVATE HIGH-SPEED SEARCH

During playback or still, turn the **SHUTTLE** ring all the way to the right for forward high-speed search, or to the left for reverse high-speed search.

- For forward search with a visible picture, turn the **SHUTTLE** ring all the way to the right and release it within 1 second.
- For reverse search with a visible picture, turn the **SHUTTLE** ring all the way to the left and release it within 1 second.

OR

Press **FF** for forward high-speed search, or **REW** for reverse high-speed search.

- For short searches, press and hold **FF** or **REW** for over 2 seconds. When released, normal playback resumes.

To resume normal playback, press **PLAY**.

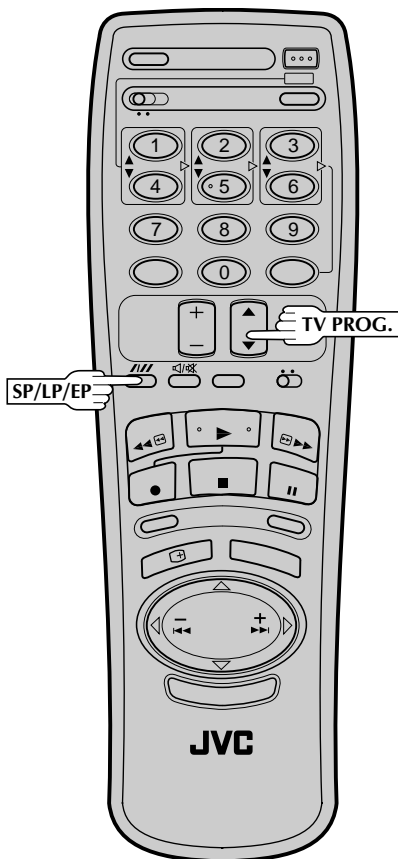
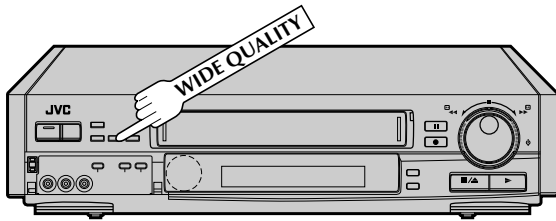

Manual Tracking

Your video recorder is equipped with automatic tracking control. During playback, you can override this and adjust the tracking manually by pressing the **TV PROG.** button.

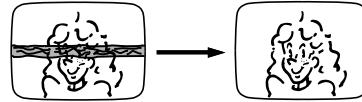

1 OVERRIDE AUTOMATIC TRACKING

Press **SP/LP/EP (///)** on the remote to engage manual tracking.

2 ADJUST TRACKING MANUALLY

Press **TV PROG. ▲** or **▼** to adjust tracking.

3 RETURN TO AUTOMATIC TRACKING

Press **SP/LP/EP (///)** on the remote to re-engage automatic tracking.

NOTE:

When a new tape is inserted, the recorder enters the automatic tracking mode automatically.

Wide Quality [E639EE only]

Use this function to improve image contrast which tends to degrade especially with wide-screen TVs.

1 ACTIVATE WIDE QUALITY

During playback, press **WIDE QUALITY** on the recorder.

- The button will light in green.
- Pressing the button again turns off the light.
- Turn on/off the light according to the type of playback picture you want.
- The setting will remain effective even though you turn on/off the recorder.
- This function is also effective with large-screen 4:3 aspect ratio TVs as well.



Instant ReView

Simply by pressing a single button, the recorder power comes on, rewinds, and begins playback of the last timer-recorded programme. If you have several programmes recorded, you can easily access any of them.

NOTES:

- Before starting, make sure that the recorder is off and that the Timer mode is disengaged.
- Turn on the TV and select the VIDEO channel (or AV mode).

1 ACTIVATE INSTANT REVIEW

Press **REVIEW**. The recorder power comes on and the recorder searches for the index code indicating the start of the last timer-recorded programme. Once it's found, playback begins automatically.

If you have, for example, 3 programmes and wish to watch the first of the 3 programmes, press **REVIEW** three times. The recorder searches and begins playback automatically. You can access a programme as far as 9 index codes away from the current tape position.

NOTE:

Instant ReView is not possible while the recorder is in the Timer mode.

Repeat Playback

Your video recorder can automatically play back the whole tape 20 times repeatedly.



1 START PLAYBACK

Press **PLAY**.

2 ACTIVATE REPEAT PLAYBACK

Press **PLAY** and hold for over 5 seconds, then release.

- "PLAY" on the display panel blinks slowly.
- The tape plays 20 times automatically, and then stops.

3 STOP PLAYBACK

Press **STOP** at any time to stop playback.

NOTE:

Pressing **PLAY**, **REW**, **FF** or **PAUSE** also stops Repeat Playback.

Index Search

Your recorder automatically marks index codes at the beginning of each recording. This function gives you quick access to any one of 9 index codes in either direction.



NOTE:

Before starting, make sure the recorder is in the Stop mode.

1 ACTIVATE INDEX SEARCH

Press **PUSH JOG** ◀ or ▶ (◀◀◀ or ▶▶▶). "◀◀◀ 1" or "▶▶▶ 1" is displayed on screen and search begins in the corresponding direction.

- To access index codes 2 through 9, press **PUSH JOG** ◀ or ▶ repeatedly until the correct index number is displayed.

Ex.: To locate the beginning of B from the current position, press **PUSH JOG** ◀ twice.

To locate the beginning of D from the current position, press **PUSH JOG** ▶ once.

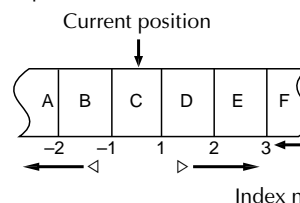

- When the specified index code is located, playback begins automatically.

Counter Memory

Returns to the counter reading of "0:00:00" to conveniently find a specific place on the tape automatically.

1 SET COUNTER MEMORY

Press **C. RESET** during playback at a point you wish to locate later. The counter reads "0:00:00". Then press **C. MEMORY**, and "M" appears on the front display panel.

2 ACTIVATE COUNTER MEMORY

When you wish to return to the designated point, press **STOP** and then **REW** or **FF**.

- The tape rewinds or fast-forwards and stops at about 0:00:00 automatically.
- To cancel Counter Memory, press **C.MEMORY** again.

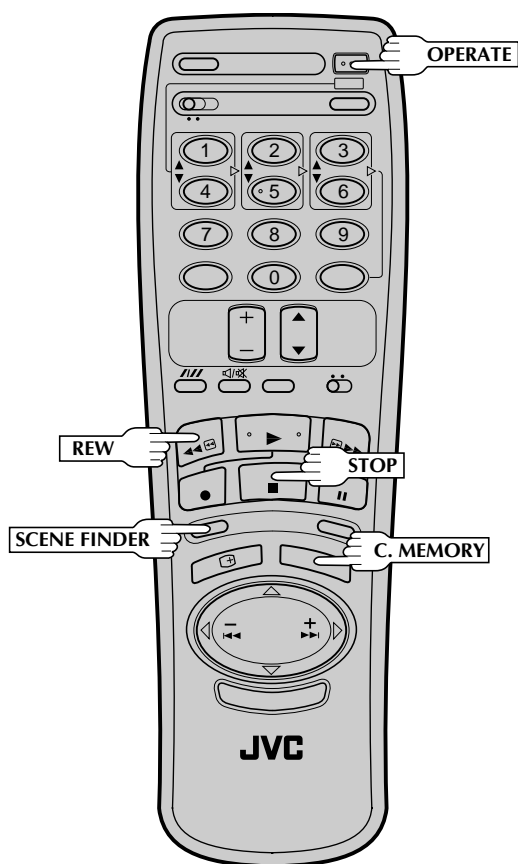
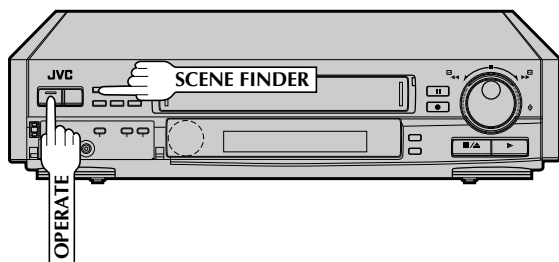

Scene Finder

This function helps you check contents of unlabeled recorded tapes at the touch of a single button.

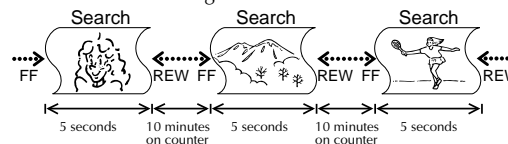

NOTE:

Scene Finder cannot be used when the recorder is in the Record mode.

1 ACTIVATE SCENE FINDER

Press **SCENE FINDER**. The recorder starts forward high-speed search for 5 seconds and then fast-forwards 10 minutes on the counter. This cycle is repeated until the end of the tape is reached.

- To start Scene Finder in the reverse direction, press **SCENE FINDER** and then press the **REW** button within 2 seconds. This cycle is repeated until the beginning of the tape.
- During Scene Finder, "PLAY" appears blinking on the display panel. During fast forward or rewind, "FF" or "REW" appears on screen.

2 STOP SCENE FINDER

Press **STOP**.

NOTES:

- During Scene Finder high-speed search, you can also hear the tape sound. During fast forward or rewind, you hear the current TV sound instead.
- Scene Finder does not function during Index Search.

Next Function Memory

You can set your recorder's power to go off automatically after the tape is fully rewound. Before starting, make sure the recorder is in the Stop mode.

For Automatic Power Off After Tape Rewind . . .

. . . press **REW**, then press **OPERATE** within 2 seconds.

NOTE:

If you want the power to be turned off automatically when the counter reads "0:00:00" (instead of at the beginning of the tape), press **C.MEMORY** so that the "M" mark appears before pressing **REW**.



Remote A/B Code Switching

The remote control is capable of controlling two JVC video recorders independently; one set to respond to the remote control's A code control signals and another set to respond to B code control signals. The remote control is preset to send A code signals because your video recorder is initially set to respond to A code signals. You can easily modify your video recorder to respond to B code signals.

1

REMOVE POWER SUPPLY

Unplug the mains power cord from the mains outlet.

2

SET A/B CODE SWITCH

Set to B.

3

RE-SUPPLY POWER

Plug the mains power cord back into the mains outlet.

4

TURN THE RECORDER ON

Press **OPERATE** on the remote control. The recorder will now only respond to B code signals.

NOTE:

Some TV sets may malfunction in response to the B mode. If this happens, switch back to the A mode.

Tape Position Indicator

The tape position indicator appears on screen when, from the Stop mode, you press **FF**, **REW** or perform an Index Search. The position of "■" in relation to "0" (beginning) or "+" (end) shows you where you are on the tape.

"O.S.D." (pg. 5) must be set to "ON", or the indicator will not appear.

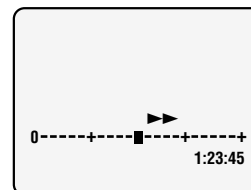

NOTE:

Depending on the type of tape used, there may be times when the indication is not correct.

Rental Return (E639EE only)

Simply by pressing one button, the recorder stops, rewinds, and ejects the tape for you. A quick and easy way to rewind rental video tapes before you return them to the shop.

1

ACTIVATE RENTAL RETURN

Anytime except during recording, press **RENTAL RETURN**.



- The recorder will rewind the tape to the beginning and eject it.
-  on the display panel will blink while in the Rental Return mode.
- To cancel the Rental Return mode, press **STOP**.

Soundtrack Selection [E639EE only]

Your video recorder is capable of recording three soundtracks (HI-FI L, HI-FI R and NORM) and will play back the one you select.

During Playback

Pressing **AUDIO MONITOR** (or  on the remote control) changes the soundtrack being played back as follows:

TRACK		USE
Recorder's Front Panel	On-Screen Display	
L + R	HI FI L  R	For Hi-Fi stereo tapes
L	HI FI L 	For main audio of Bilingual tapes
R	HI FI  R	For sub audio of Bilingual tapes
NORM	NORM	For audio-dubbed tapes
L + R + NORM	HI FI NORM	For audio-dubbed tapes

NOTES:

- "L + R" should normally be selected. In this mode, Hi-Fi stereo tapes are played back in stereo, and the NORM track is played back automatically for tapes with only normal audio.
- "O.S.D." must be set to "ON" or the on-screen displays will not appear (pg. 5).

Basic Recording

Turn on the TV and select the VIDEO channel (or AV mode).

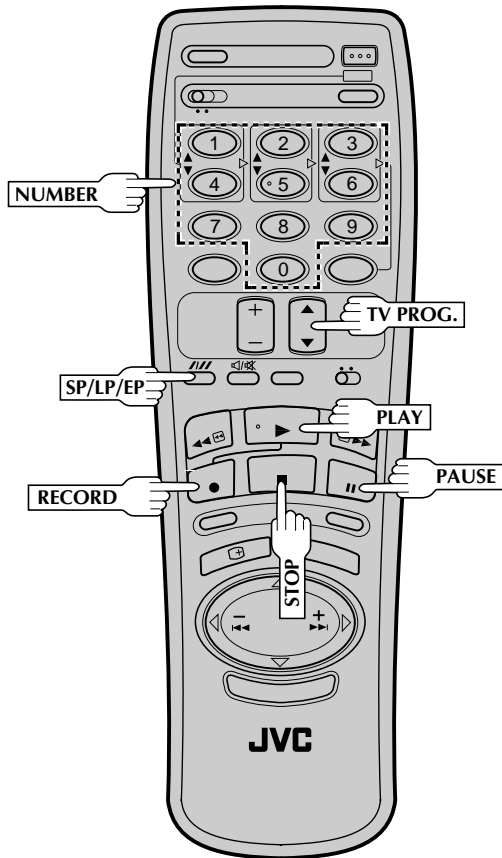
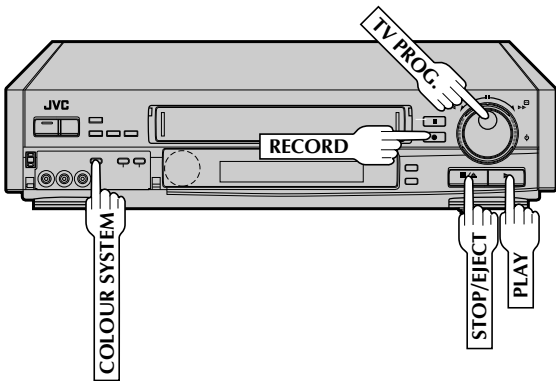

TV signals being received by the recorder's built-in tuner can be recorded onto a video tape. You can "capture" a TV programme using your video recorder.

1 LOAD A CASSETTE

Insert a cassette with the record safety tab intact.

- The counter is reset to 0:00:00 and the recorder power comes on automatically.
- Select the appropriate colour system by pressing the **COLOUR SYSTEM** button. (☞ pg. 24)

2 CHOOSE A PROGRAMME

Press **TV PROG.** ▲/▼ or the **NUMBER** keys to select the channel you wish to record.

- The **TV PROG.** dial can also be used to select a channel.

3 SET TAPE SPEED

Press **SP/LP/EP**. Check the SP/LP* indicator on the recorder display panel to confirm the selected tape speed.

*EP is displayed on screen only.

4 START RECORDING

Press and hold **RECORD** and **PLAY** on the remote control, or press **RECORD** on the recorder.

B.E.S.T. takes place at the beginning of each first SP and first LP (or EP) recording after inserting the cassette (☞ pg. 18).

5 PAUSE/RESUME RECORDING

Press **PAUSE**. Press **PLAY** to resume recording.

6 STOP RECORDING

Press **STOP** on the remote control or **STOP/EJECT** on the recorder. Then press **STOP/EJECT** to remove the cassette.

NOTE (For HR-E639EE Owners):

Hi-Fi audio recording in NTSC EP mode is not possible.

Accidental erasure prevention

- To prevent accidental recording on a recorded cassette, remove its safety tab. To record on it later, cover the hole with adhesive tape.

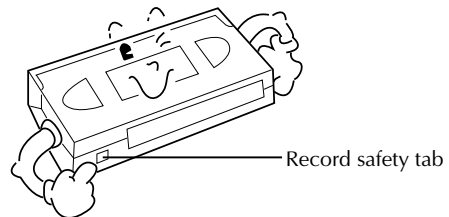



Recording Features

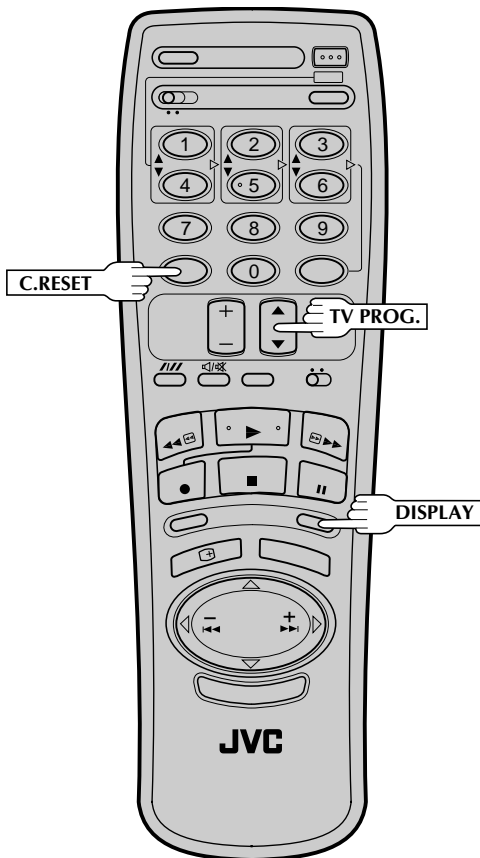
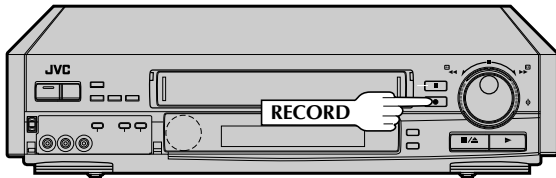

Record One Programme While Watching Another

1 SELECT CHANNEL TO WATCH

Once recording is in progress, all you need to do is to set the channel controls on the TV for the station you wish to view.

- The programme selected with the TV's channel controls appears on the TV screen while the one selected with the **TV PROG.** button(s) is recorded on the tape.

Elapsed Recording Time Indication

You can check the exact time of a recording.

1 SET COUNTER DISPLAY

Press **DISPLAY** until a counter reading appears on the display panel.

- Pressing the button changes the type of display: Channel, Clock or Counter.

2 RESET COUNTER

Press **C. RESET** before starting recording or playback.

- The counter is reset to "0:00:00" and shows the exact elapsed time as the tape runs.

Instant Timer Recording (ITR)

This easy method lets you record for from 30 minutes to 6 hours (selectable in 30-min. increments), and shuts the recorder off after recording is finished.

1 START RECORDING

Press **RECORD** on the recorder.

2 ENGAGE ITR MODE

Press **RECORD** again. "REC" blinks and 0:30 appears on the front display panel.

3 SET RECORDING DURATION

If you want to record for more than 30 minutes, press **RECORD** to extend the time. Each press extends recording time by 30 minutes.

NOTE:

You can only perform ITR using the **RECORD** button on the recorder's front panel.



B.E.S.T. Picture System

Turn on the TV and select the VIDEO channel (or AV mode).

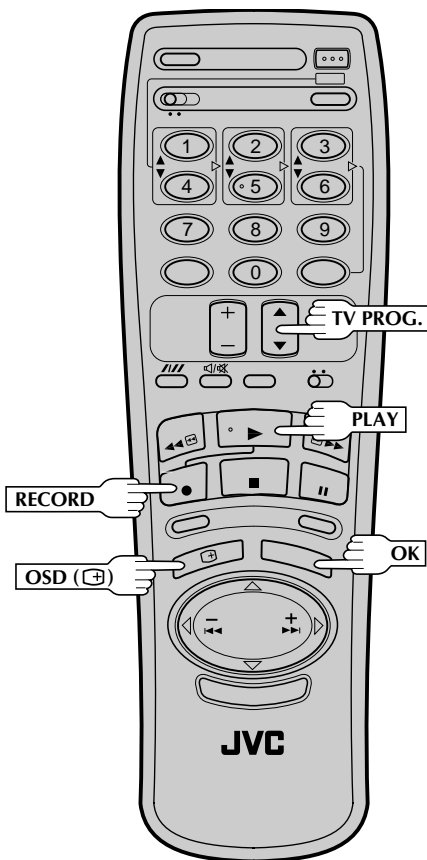
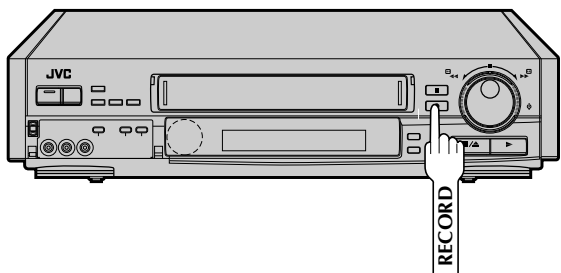

The B.E.S.T. (Biconditional Equalised Signal Tracking) system checks the condition of the tape in use during recording and playback, and compensates to provide the highest-possible recording and playback pictures. The default setting is "ON".

Recording

LOAD A CASSETTE

- 1 Insert a cassette with the record safety tab intact.
 - The recorder power comes on automatically.

ACCESS MODE SELECT SCREEN

- 2 Press OSD (⊕) and the Language screen appears. (To change the language, see pg. 5) Press OK on the remote control.

CONFIRM B.E.S.T. STATUS

- 3 The default setting is "ON". If this is the case, go to step 4. If not, press TV PROG.▼ to place the pointer next to "B.E.S.T.", then press OK to set to "ON".

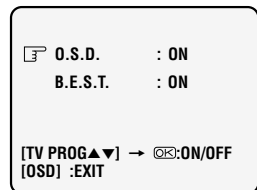

CLOSE MODE SELECT SCREEN

- 4 Press OSD (⊖).

START RECORDING

- 5 Press and hold RECORD and PLAY on the remote, or press RECORD on the recorder.
 - The recorder spends approximately 7 seconds assessing the condition of the tape, then begins recording.
 - "B.E.S.T." appears on screen and blinks when adjustment is complete.

Display Panel Indication [E639EE only]



As the tape check progresses, the "—" marks on the display panel increase upward.

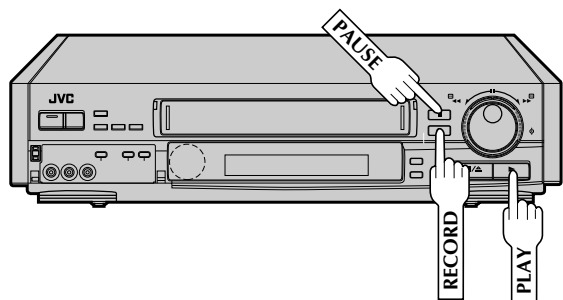

NOTES:

- The B.E.S.T. system works for SP and LP (or EP) modes only after a tape has been inserted and the Record mode is first initiated. It does not work during recording.
- In the case of timer recording, the B.E.S.T. system works before recording is initiated.
- Once the cassette is ejected, the B.E.S.T. data is cancelled. The next time the cassette is used for recording, B.E.S.T. is re-performed.

ATTENTION:

Since the B.E.S.T. system works before recording actually starts, there is a delay of approximately 7 seconds after **RECORD** and **PLAY** on the remote are pressed, or **RECORD** on the recorder is pressed. To make sure you record the desired scene or programme in its entirety, first perform the following steps:

- 1) Press and hold **PAUSE** and **RECORD** to engage the RECORD PAUSE mode.
 - The recorder then automatically checks the condition of the tape and, after approximately 7 seconds, re-enters RECORD PAUSE.
- 2) Press **PLAY** to start recording.
 - If you want to bypass the B.E.S.T. system and begin recording immediately, set "B.E.S.T." to "OFF" in step 3 on page 18.

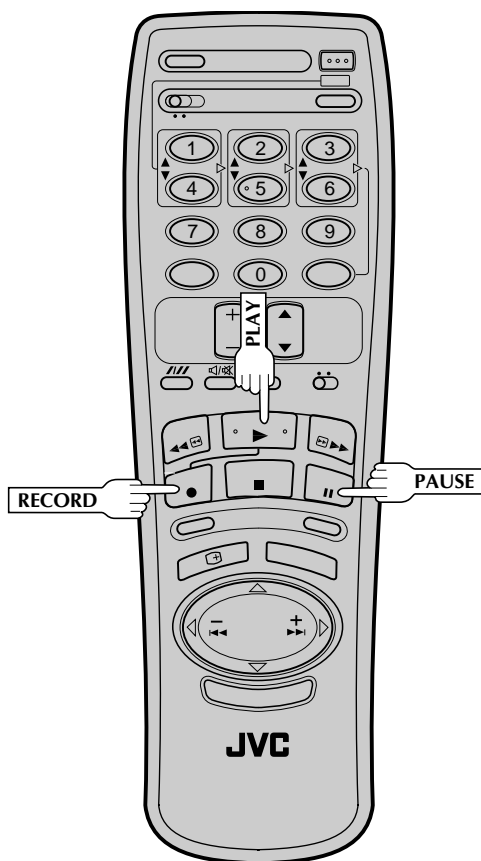

Playback

The recorder assesses the quality of the tape once you initiate playback.

When watching a tape recorded with "B.E.S.T." set to "ON", it is recommended that you leave B.E.S.T. on during playback as well.

START PLAYBACK

1

Press **PLAY**.

- The recorder adjusts the playback picture quality based on the quality of the tape in use.
- B.E.S.T. is active during Auto Tracking.
- "B.E.S.T." appears blinking on the screen.

NOTES:

- When watching a rental tape, or one recorded on another video recorder, set B.E.S.T. to your preference by performing steps 2 through 4 on page 18.
- "B.E.S.T." only appears at the beginning of automatic tracking. Even though it doesn't appear after that, the B.E.S.T. function is operative.



Timer Programming

Remember, the clock must be set before you can programme the timer (pg. 9).

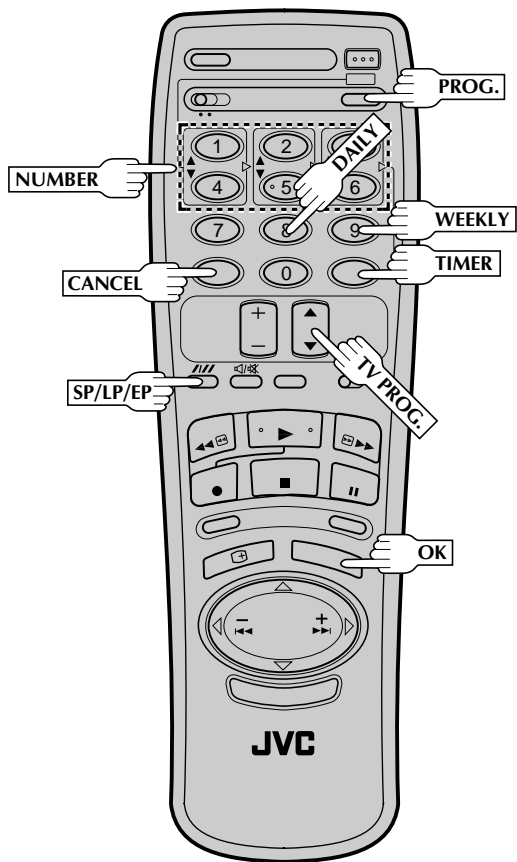
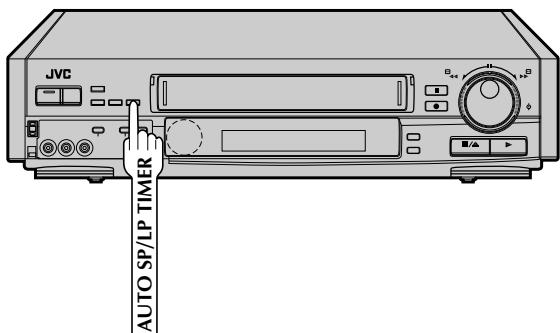

- Before performing the following steps:
- Insert a cassette with the safety tab in place. The recorder will come on automatically.
 - Turn on the TV and select the VIDEO channel (or AV mode).
 - Select the appropriate colour system by pressing the COLOUR SYSTEM button. (pg. 24)

1 ACCESS MODE SELECT SCREEN

Press **PROG.**

2 ACCESS TIMER PROGRAMMING SCREEN

Press **TV PROG.▲/▼** to place the pointer next to "TIMER PROGRAMMING", then press **OK** on the remote control.

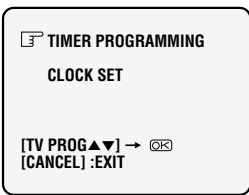

3 ENTER PROGRAMME START TIME

Press **NUMBER** key "1(▲)" or "4(▼)" to enter the time you want recording to start.

- Press and hold either button to delay or advance the time by 30 minutes.
- If the Programme is already used, press **PROG.** until a vacant Programming screen appears.

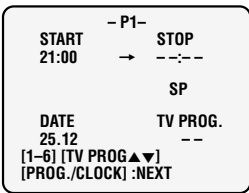

4 ENTER PROGRAMME STOP TIME

Press **NUMBER** key "2(▲)" or "5(▼)" to enter the time you want recording to stop.

- Press and hold either button to delay or advance the time by 30 minutes.



5 ENTER PROGRAMME DATE

Press **NUMBER** key "3(▲)" or "6(▼)" to enter the date.



6 ENTER CHANNEL POSITION

Press **TV PROG.**▲/▼ to select the channel you wish to record.

START 21:00	- P1 - →	STOP 22:00
SP		
DATE 25.12	TV PROG. 1	
[1-6] [TV PROG▲▼] [PROG./CLOCK] :NEXT		

7 SET TAPE SPEED

Press **SP/LP/EP** to set the tape speed.

- For each additional programme, press **PROG.** and repeat steps 3 – 7.

8 RETURN TO NORMAL SCREEN

Press **PROG.** as many times as necessary to return to normal screen.

9 ENGAGE RECORDER'S TIMER MODE

Press **TIMER**.

To Timer-Record Weekly Or Daily Serials . . .

. . . anytime during steps 3 through 7, press **WEEKLY** (NUMBER key "9") for weekly serials or **DAILY** (NUMBER key "8") for daily serials (Monday–Friday).

NOTES:

- You can programme this recorder to timer-record as many as 8 programmes. To record the extra programme, you must first cancel any unnecessary programmes (☒ Check And Cancel Programmes).
- For safety, your recorder disables all other functions while in the Timer mode. If you want to use the recorder but its Timer mode is engaged, press **TIMER** and all other functions are operable. To re-engage the timer, press **TIMER**.
- In case of a power failure after programming, the recorder's memory backup keeps your selections for 18 hours.
- Backup time becomes shorter as the unit's internal parts become old. When this occurs, please consult your nearby JVC dealer.

Check And Cancel Programmes

1 ACCESS TIMER PROGRAMMING SCREEN

Perform steps 1 and 2 of Timer Programming to call up the Timer Programming screen.

- If the recorder is in the Timer mode, first press **TIMER** to exit the mode.

2 SELECT PROGRAMME

Press **PROG.** until the programme you wish to call up appears.

- Each time you press **PROG.** the next programme's information appears up to "P8" (Programme 8).
- If you want to make a correction, use **NUMBER** key "1" – "6" and **TV PROG.**▲/▼.
- If you want to cancel a programme, press **CANCEL**.

3 RETURN TO NORMAL SCREEN

Press **PROG.** as many times as necessary to return to normal screen.

- Press **TIMER** to engage the recorder's timer mode.

Auto SP/LP Timer

If, when recording in SP mode, there is not enough tape to record the entire programme, the recorder automatically switches to LP mode (with PAL broadcasts) or EP mode (with NTSC broadcasts) to allow complete recording.

1 ENGAGE AUTO SP/LP TIMER

Press **AUTO SP/LP TIMER** on the recorder front panel. The button lights "orange".

For Example . . .

Recording a PAL-broadcast program of 210 minutes in length onto a 180-minute tape

Approximately 150 minutes Approximately 60 minutes

SP mode	LP mode
Total 210 minutes	

Make sure you press **AUTO SP/LP TIMER** before performing timer programming.

NOTES:

- The Auto SP/LP Timer feature is not available during ITR (Instant Timer Recording), and the feature will not work properly with any tapes longer than E-180 as well as some tapes of shorter lengths.
- Even if, in step 1, you press **AUTO SP/LP TIMER** and it lights "orange", that doesn't mean that the recorder will automatically change from SP to LP (or EP) mode during the course of the recording. Watch the tape later to confirm.
- If you have programmed the recorder to timer-record 2 or more programs, the second programme and those thereafter may not fit on the tape if you engage the Auto SP/LP Timer mode. In this case, make sure the mode is not engaged, then set the tape speed manually during timer programming.
- There may be some noise at the point on the tape where the recorder switches from SP to LP (or EP) mode.



Edit To Or From Another Video Recorder

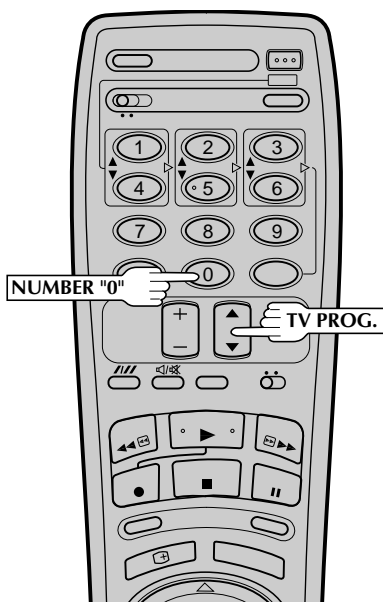

IMPORTANT:

- To edit, both the player and the recorder must be of the same colour system. Press your recorder's **COLOUR SYSTEM** button to select the appropriate colour system.
- For more information on multi-system compatibility, see pg. 24.

You can use your video recorder as the source player or the recording deck.

1 MAKE CONNECTIONS

Connect the player's AUDIO/VIDEO OUT connector to the recorder's AUDIO/VIDEO IN connector.

For HR-E639EE Owners . . .

- When connecting to a monaural recorder, connect your recorder's AUDIO L IN/OUT connector to the AUDIO IN/OUT connector on the monaural recorder.

For HR-E539EE Owners . . .

- When connecting to a Hi-Fi recorder, connect your recorder's AUDIO IN/OUT connector to the AUDIO L IN/OUT connector on the Hi-Fi recorder.

2 SET RECORDING DECK'S INPUT MODE

Set to AUX. With this video recorder, press **NUMBER** Key "0" or **TV PROG.**"F-AU"* will appear instead of a channel number.

* "AU" will appear with HR-E539EE.

3 START SOURCE PLAYER

Engage its Play mode.

4 START RECORDING DECK

Engage its Record mode.

NOTES:

- All necessary cables can be obtained from your dealer.
- NTSC tapes being played back in the NTSC → PAL mode (see p. 25) cannot be dubbed to another recorder.
- When you dub an NTSC tape using your recorder as the playback deck, select NTSC 3.58 (or NTSC 4.43) with the **COLOUR SYSTEM** button. (see p. 24)

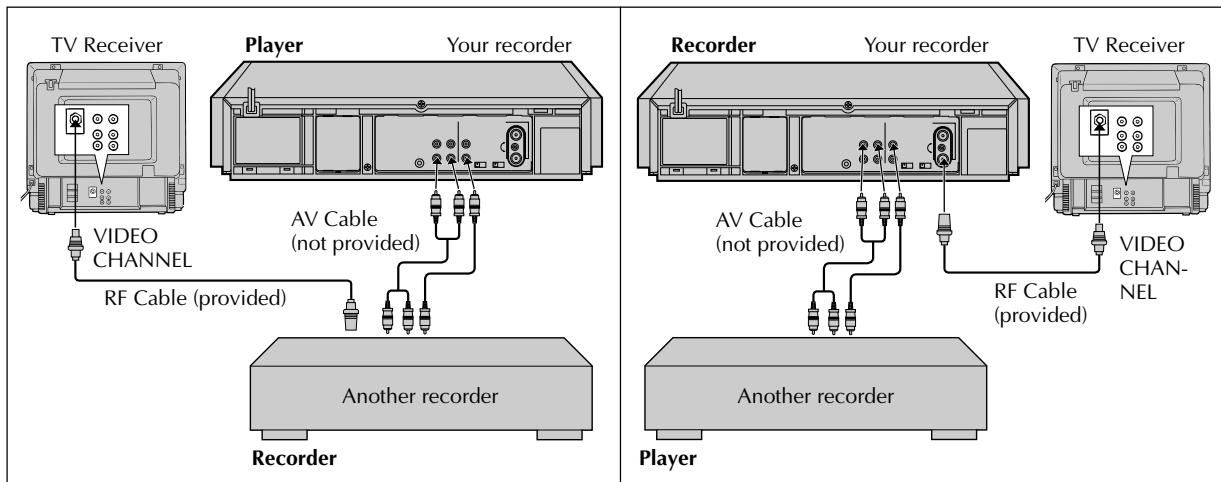



Edit From A Camcorder

You can use a camcorder as the source player and your video recorder as the recorder.

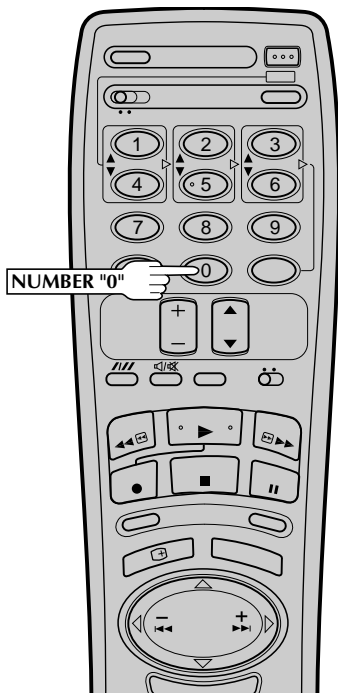

1 MAKE CONNECTIONS

Connect the camcorder's AUDIO/VIDEO OUT connectors to the recorder's front panel AUDIO/VIDEO input connectors.

For HR-E639EE Owners . . .

- When using a monaural camcorder, connect its AUDIO OUT connector to the AUDIO IN L connector on your recorder.

For HR-E539EE Owners . . .

- When using a Hi-Fi camcorder, connect the camcorder's AUDIO OUT L connector to the AUDIO IN connector on your recorder.

- When a Master Edit Control-equipped JVC camcorder is used, the camcorder is capable of controlling the recorder. Refer to the camcorder's instruction manual for operating procedure.

2 SET RECORDER'S INPUT MODE

Press NUMBER key "0". "F-AU"* appears in place of a channel number.

* "AU" will appear with HR-E539EE.

3 START CAMCORDER

Engage its Play mode.

4 START RECORDER

Engage its Record mode.

NOTE:

Connections made to the front panel AUDIO/VIDEO input connectors automatically override those made to the rear panel AUDIO/VIDEO input connectors.

IMPORTANT:

- To edit, both the player and the recorder must be of the same colour system. Press your recorder's **COLOUR SYSTEM** button to select the appropriate colour system.
- PAL, SECAM and NTSC camcorders can be used as a player for editing.
- For more information on multi-system compatibility, see pg. 24.

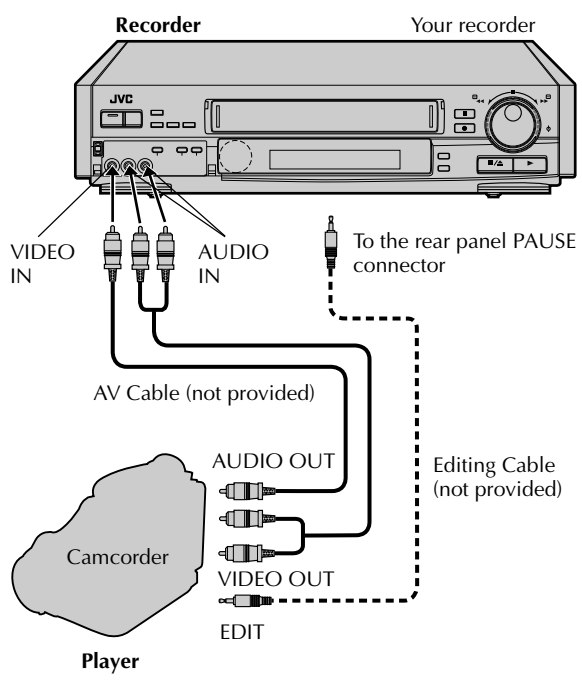



Setting Of The Colour System Select Buttons

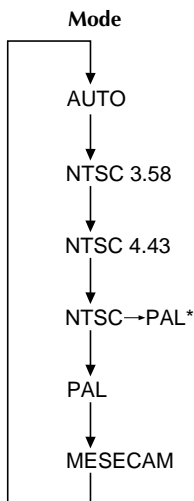

Use the **COLOUR SYSTEM** button on the recorder's front panel to select the colour system. Pressing this button changes the mode as illustrated on the left. The On-Screen display will show which mode is selected.

Mode Display	Description
AUTO (Colour Signal)	Usually set to this mode. This mode automatically detects PAL, NTSC, SECAM or MESECAM and adjusts to the colour system being recorded or played back. When it does not perform properly, set the colour system manually.
MANUAL (Colour Signal)	For recording, there is a choice of 4 selectable modes; PAL/MESECAM/NTSC 3.58/NTSC4.43. Select the mode that matches the colour signal being received. For playback, there is an additional mode which allows NTSC tapes to be played back and viewed on PAL TVs.

* "NTSC → PAL" appears during playback only.

NOTES:

- In the **AUTO** mode, NTSC signals will be automatically recorded as NTSC 3.58.
- In the **AUTO** mode, NTSC tapes will be played back as NTSC 3.58.
- SECAM signals will always be recorded as MESECAM. Select the **AUTO** or the **MESECAM** mode when recording SECAM signals.
- When playing back a SECAM tape, select the **AUTO** or the **MESECAM** mode. The playback picture will always be monochrome.
- In the **NTSC4.43** mode, with some TVs, on-screen displays (Program screen etc.) may roll up or down and there may be a loss of colour. When this happens, select the **AUTO** mode.

Off-Air Recording

The built-in multi-system tuner is capable of receiving PAL B/G and D/K, and SECAM B/G and D/K broadcasts.

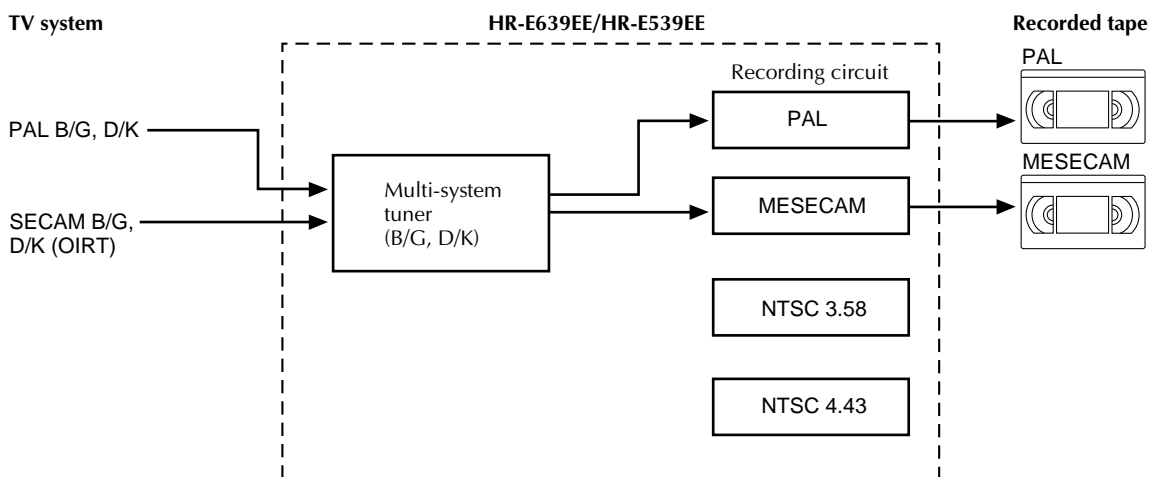

NOTE:

This model does not operate in BRAZIL (PAL-M) or ARGENTINA (PAL-N).



Playback

This recorder can play back all 3 types of recorded tape.

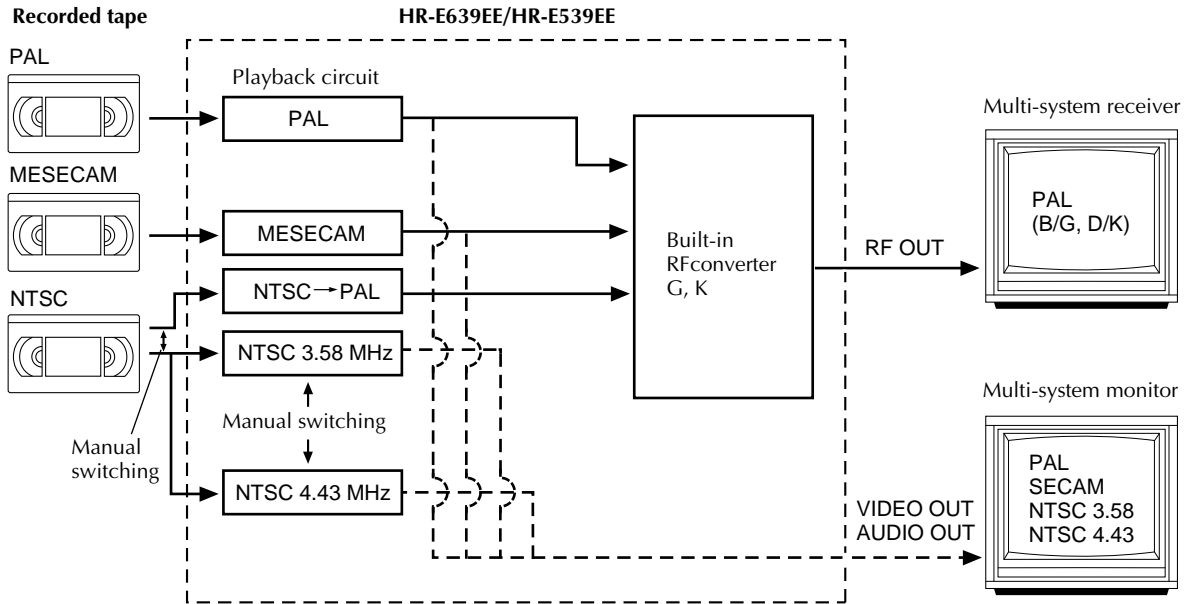

NOTES:

When viewing NTSC tapes on a PAL TV set:

- The picture may shrink vertically with black bars appearing at the top and bottom of the screen. This is not a malfunction on the part of the video recorder nor the TV.
- The picture may roll up or down. This can be corrected using the V-HOLD control found on some TVs. (This cannot be corrected if the TV does not have a V-HOLD control.)
- During search, still, or frame-by-frame playback, the picture will be distorted, and there may be a loss of colour.

ATTENTION:

When this recorder is connected to a multi-system TV, the audio signal may not be heard or may be noisy if the colour system select switch of the TV is adjusted to the AUTO position. In such a case, change the setting of the colour system select switch of the TV to the position which corresponds to the setting (G or K) of the RF converter system select switch on the rear panel of the recorder.

Tape-To-Tape Editing

There are 4 different types of recorded tape, depending on the signal recorded.

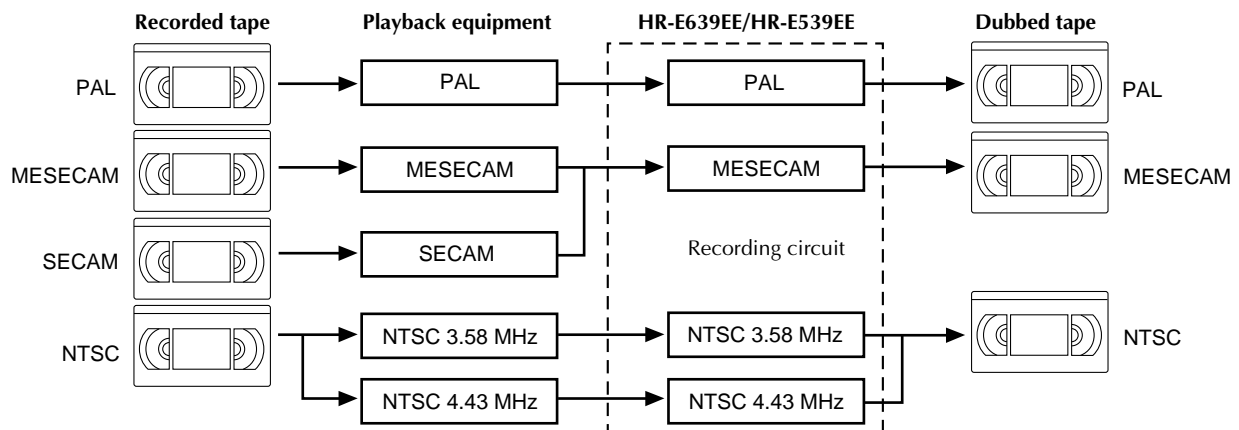

Multi-Brand Remote Control

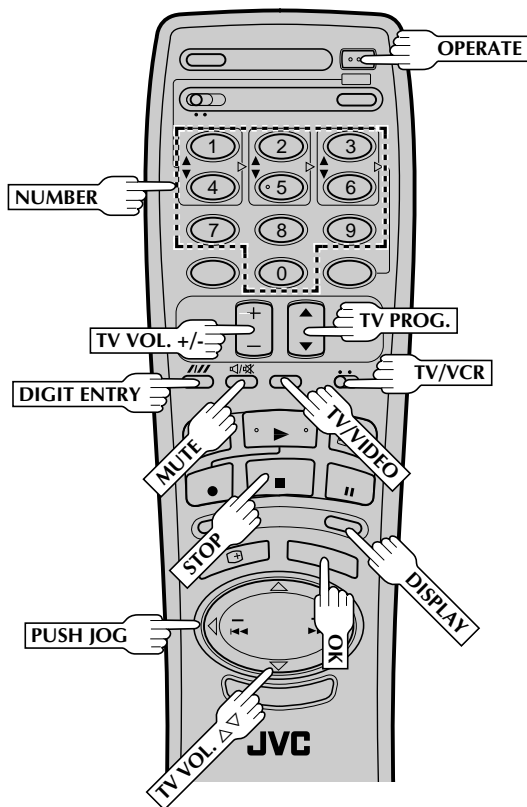

CODE	TV BRAND NAME
01	JVC
02	BRANDT, NORDMENDE, SABA, TELEAVIA, TELEFUNKEN, THOMSON
03	FERGUSON
04	PHILIPS
05	BLAUPUNKT, GRUNDIG
06	SONY
07	PANASONIC
08	GRAETZ, ITT, LUXOR, SALORA, SELECO
09	MIVAR
10	HITACHI
11	TOSHIBA
12	MITSUBISHI
13	FINLUX
14	NOKIA
15	SHARP
16	SAMSUNG

Your remote control can operate the basic functions of your TV set. In addition to JVC TVs, other manufacturer's TVs can also be controlled by setting the appropriate switch on the remote control.

Before you start . . .

- Turn on the TV using its remote control.
- Set the remote control's **TV/VCR** switch to TV.

NOTE:

If your TV is a JVC, you don't have to set the code in step 1. Go to step 2.

1 SET TV BRAND CODE

Refer to the chart below. While holding down **OPERATE**, enter your TV's brand code using the **NUMBER** keys, then press **STOP**.

- You don't have to repeat this step until you replace your remote control's batteries.

2 TRY OPERATING TV

Press **OPERATE** on the remote to turn the TV off. If it goes off, try other operations.

- The **OPERATE** button, **TV/VIDEO** button, **TV PROG.** ▲/▼ button, **TV VOL. +/-** (or ▲/▼) button and **MUTE** button on the remote can all be used to operate the TV.
- To return the remote to video recorder control, set its **TV/VCR** switch to VCR.

IMPORTANT

Although the provided remote control unit is compatible with JVC televisions, as well as many other models, it may not work with your TV, or in some instances, may have limited function capability.

Control Your TV Using Additional Buttons

The **NUMBER** keys on the remote can also be used to select the TV's channel by setting the remote control to the TV mode.

- 1 Set the **TV/VCR** switch to TV.
- 2 Use the **NUMBER** keys, and the **DIGIT ENTRY** (*///*) button, the **PUSH JOG** button, the **DISPLAY** button or the **OK** button to select the TV's channel.
 - With televisions under Code 01, 03, 04, 06, 07, 10 or 11, the **DIGIT ENTRY** button corresponds to the 1-digit/2-digit entry switching button (often labelled - / -) of your TV's remote control.
 - With televisions under Code 01, 08 or 09, the **PUSH JOG** < button corresponds to the 10 + button, and the **PUSH JOG** > button corresponds to the 20 + button of your TV's remote control.
 - With televisions using Code 09, the **DISPLAY** button corresponds to the 30 + button.
 - With televisions using Code 06, the **OK** button corresponds to the ENTER button of your TV's remote control.

NOTE:

The way these buttons are used is determined by your TV. Use these buttons as instructed for your TV's remote control.

Before requesting service for a problem, use this chart and see if you can repair the trouble yourself. Small problems are often easily corrected, and this can save you the trouble of sending your video recorder off for repair.

POWER		
SYMPTOM	POSSIBLE CAUSE	CORRECTIVE ACTION
1. No power is applied to the recorder.	<ul style="list-style-type: none"> The mains power cord is disconnected. 	Connect the mains power cord.
2. The clock is functioning properly, but the recorder cannot be powered.	<ul style="list-style-type: none"> "TIMER" is displayed on the display panel. 	Press the TIMER button to turn the "TIMER" indicator off.
TAPE TRANSPORT		
SYMPTOM	POSSIBLE CAUSE	CORRECTIVE ACTION
1. The tape does not run during recording.	<ul style="list-style-type: none"> The recorder is in the Pause mode. 	Press PLAY to disengage the Pause mode.
2. The tape stops during rewind or fast-forward.	<ul style="list-style-type: none"> "M" is displayed on the display panel. 	Press C.MEMORY to deactivate the Counter Memory function and turn the "M" indicator off.
3. The tape will not rewind or fast-forward.	<ul style="list-style-type: none"> The tape is already fully rewound or fast-forwarded. 	Check the cassette.
PLAYBACK		
SYMPTOM	POSSIBLE CAUSE	CORRECTIVE ACTION
1. The playback picture does not appear while the tape is running.	<ul style="list-style-type: none"> If you're using the RF OUT connection, the TV receiver's channel selector is set to the wrong video channel. If you're using the AV connection, the TV receiver is not set to the AV mode. 	<p>If you are using the RF OUT connection, set the TV receiver to the RF converter channel (UHF 36). (☞ pg. 3)</p> <p>If you are using the AV connection, set the TV to its AV mode.</p>
2. Noise appears during visual search.	<ul style="list-style-type: none"> This is normal. 	
3. Noise appears during normal playback.	<ul style="list-style-type: none"> The automatic tracking mode is engaged. 	Try manual tracking. (☞ pg. 12)
4. Noise appears during slow-motion playback.	<ul style="list-style-type: none"> The automatic tracking mode is engaged. 	Try manual tracking. (☞ pg. 12)
5. Noise appears during still playback.		Press TV PROG. ▲ or ▼ a few times to remove the noise bars from the screen.
6. [E639EE only] Breaks are noticeable in Hi-Fi soundtrack.	<ul style="list-style-type: none"> Automatic tracking is engaged. 	Engage and adjust tracking manually. (☞ pg. 12)
7. The playback picture is blurred or interrupted while TV broadcasts are clear.	<ul style="list-style-type: none"> The video heads may be dirty. 	Consult your JVC dealer.
8. Playback picture has a loss of colour.	<ul style="list-style-type: none"> The wrong colour system is selected for the tape being played back. The wrong colour system was selected during recording. 	<p>Select the correct colour system by pressing the COLOUR SYSTEM button. (☞ pg. 24)</p> <p>Once recorded, the signal cannot be corrected. Be sure to choose the correct setting before recording.</p>
9. No sound accompanies the playback picture.	<ul style="list-style-type: none"> The SYSTEM switch on the recorder's rear panel is set to the wrong position. 	Set it to the correct position for the TV broadcast system used in your area. (☞ pg. 4.)

CONTINUED ON NEXT PAGE.

RECORDING

SYMPTOM	POSSIBLE CAUSE	CORRECTIVE ACTION
1. Recording cannot be started.	<ul style="list-style-type: none"> There is no cassette loaded, or the cassette loaded has had its Record Safety tab removed. 	Insert a cassette, or using adhesive tape, reseal the slot where the tab was removed.
2. TV broadcasts cannot be recorded.	<ul style="list-style-type: none"> "AU" has been selected as the input mode. 	Set to the desired channel.
3. Tape-to-tape editing is not possible.	<ul style="list-style-type: none"> The source (another video recorder, camcorder) has not been properly connected. All necessary power switches have not been turned on. The input mode is not correct. 	<p>Confirm that the source is properly connected.</p> <p>Confirm that all units' power switches are turned on.</p> <p>Set the input mode to "AU".</p>
4. Camcorder recording is not possible.	<ul style="list-style-type: none"> The camcorder has not been properly connected. The input mode is not correct. 	<p>Confirm that the camcorder is properly connected.</p> <p>Set the input mode to "AU".</p>

TIMER RECORDING

SYMPTOM	POSSIBLE CAUSE	CORRECTIVE ACTION
1. Timer recording won't work.	<ul style="list-style-type: none"> The clock and/or the timer have been set incorrectly. The timer is not engaged. 	Re-perform the clock and/or timer settings. Press TIMER and confirm that "TIMER" is displayed on the display panel.
2. On-screen timer programming is not possible.	<ul style="list-style-type: none"> Timer recording is in progress. 	Timer programming can't be performed while a timer recording is in progress. Wait until it finishes.
3. "TIMER" and "⏏" on the display panel won't stop blinking.	<ul style="list-style-type: none"> The timer is engaged but there's no cassette loaded. 	Load a cassette with the Record Safety tab intact, or cover the hole using adhesive tape.
4. The cassette is automatically ejected, and "TIMER" and "⏏" on the display panel won't stop blinking.	<ul style="list-style-type: none"> The loaded cassette has had its Record Safety tab removed. 	Remove the cassette and cover the hole with adhesive tape, or insert a cassette with the Record Safety tab intact.
5. "TIMER" blinks for 10 seconds and the Timer mode is disengaged.	<ul style="list-style-type: none"> TIMER has been pressed when there are no programs in memory, or the timer record information has been programmed incorrectly. 	Check the programmed data and re-program as necessary, then press TIMER again.
6. The cassette is automatically ejected, the power shuts off and "TIMER" and "⏏" won't stop blinking.	<ul style="list-style-type: none"> The end of the tape was reached during timer recording. 	The programme may not have been recorded in its entirety. Next time make sure you have enough time on the tape to record the entire programme.

OTHER PROBLEMS

SYMPTOM	POSSIBLE CAUSE	CORRECTIVE ACTION
1. Whistling or howling is heard from the TV during camcorder recording.	<ul style="list-style-type: none"> The camcorder's microphone is too close to the TV. The TV's volume is too high. 	Position the camcorder so its microphone is away from the TV. Turn the TV's volume down.
2. The channel cannot be changed.	<ul style="list-style-type: none"> Recording is in progress. 	Press PAUSE to pause the recording, change channels, then press PLAY to resume recording.
3. The remote control won't operate the TV.	<ul style="list-style-type: none"> The TV/VCR switch is in the wrong position. 	Set the switch to TV.



QUESTIONS AND ANSWERS

EN 29

PLAYBACK

Q. What happens if the end of the tape is reached during playback or search?

A. The tape is automatically rewound to the beginning.

Q. Can the video recorder indefinitely remain in the still mode?

A. No. It stops automatically after 5 minutes to protect the heads.

Q. During search, slow, still and frame-by-frame playback, I can't hear any audio. What's the problem?

A. This is normal.

Q. When returning from multi-speed search to normal playback, the picture is disturbed. Should I be concerned about this?

A. No, it is normal.

Q. Noise bars appear during multi-speed search. What's the problem?

A. This is normal.

Q. Other than preventing further recording, what effect does removing the Record Safety tab have?

A. It disables marking of index codes.

Q. Sometimes, during Index Search, the video recorder can't find the programme I want to see. Why not?

A. There may be index codes too close together.

RECORDING

Q. When I pause and then resume a recording, the end of the recording before the pause is overlapped by the beginning of the continuation of recording. Why does this happen?

A. This is normal. It reduces distortion at the pause and resume points.

Q. Can the video recorder indefinitely remain in the Record-Pause mode?

A. No. The video recorder goes to its Stop mode automatically after 5 minutes to protect the heads.

Q. What happens if the tape runs out during recording?

A. The video recorder automatically rewinds it to the beginning.

TIMER RECORDING

Q. "REC" and "TIMER" remain lit on the display panel. Is there a problem?

A. No. This is a normal condition for a timer recording in progress.

Q. Can I program the timer while I'm watching a tape or a TV broadcast?

A. You won't see the picture as it is replaced by the on-screen menu, but the audio from the program or tape you're viewing can be heard.

ATTENTION:

This recorder contains microcomputers. External electronic noise or interference could cause malfunctioning. In such cases, switch the recorder off and unplug the mains power cord. Then plug it in again and turn the recorder on. Take out the cassette. After checking the cassette, operate the unit as usual.



FRONT VIEW

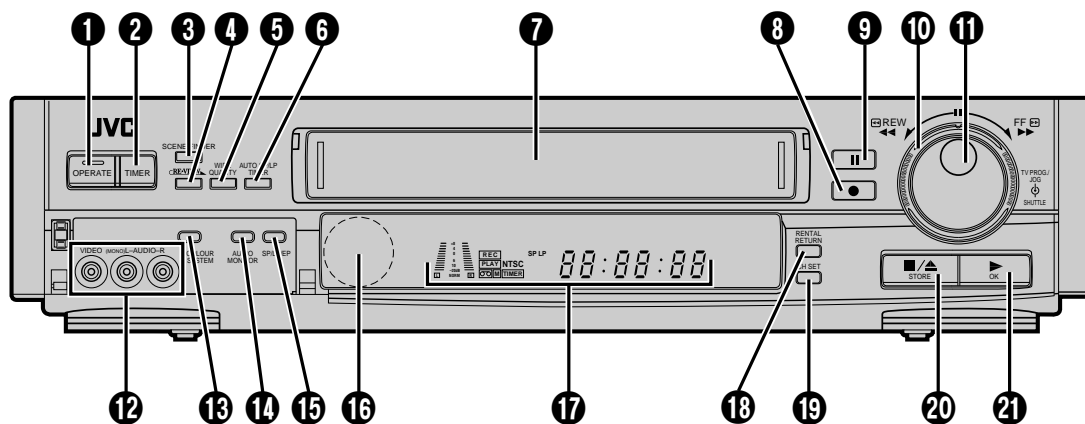

Open the lid to access covered connectors and buttons.

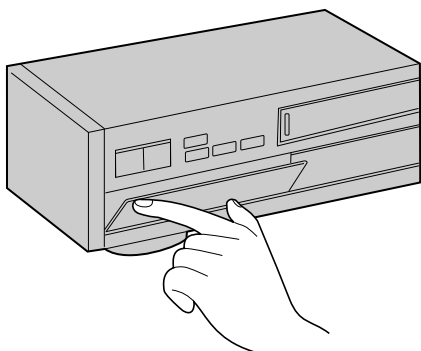

- 1 OPERATE Button (↗ pg. 4)
- 2 TIMER Button (↗ pg. 21)
- 3 SCENE FINDER Button (↗ pg. 14)
- 4 REVIEW Button (↗ pg. 13)
- 5 WIDE QUALITY Button [E639EE] (↗ pg. 12)
- 6 DISPLAY Button [E539EE] (↗ pg. 17)
- 7 AUTO SP/LP TIMER Button (↗ pg. 21)
- 8 Cassette Loading Slot
- 9 RECORD Button (↗ pg. 16)
- 10 PAUSE Button (↗ pg. 11)
- 11 SHUTTLE Ring (↗ pg. 10)
- 12 Jog Dial (↗ pg. 11)
- 13 TV PROG. Dial (↗ pg. 6)
- 14 VIDEO and AUDIO Input Connectors (↗ pg. 23)
- 15 * The HR-E539EE has only one Audio input connector.
- 16 COLOUR SYSTEM Button (↗ pg. 24)
- 17 AUDIO MONITOR Button [E639EE only] (↗ pg. 15)
- 18 SP/LP/EP Button (↗ pg. 16)
- 19 infrared Beam Receiving window
- 20 Display Panel (↗ pg. 31)
- 21 RENTAL RETURN Button [E639EE] (↗ pg. 15)
- 22 COUNTER RESET [E539EE] (↗ pg. 13)
- 23 CH SET Button (↗ pg. 6)
- 24 STOP/EJECT Button (↗ pg. 10)
- 25 STORE Button (↗ pg. 7)
- 26 PLAY Button (↗ pg. 10)
- 27 OK Button (↗ pg. 5)



DISPLAY PANEL

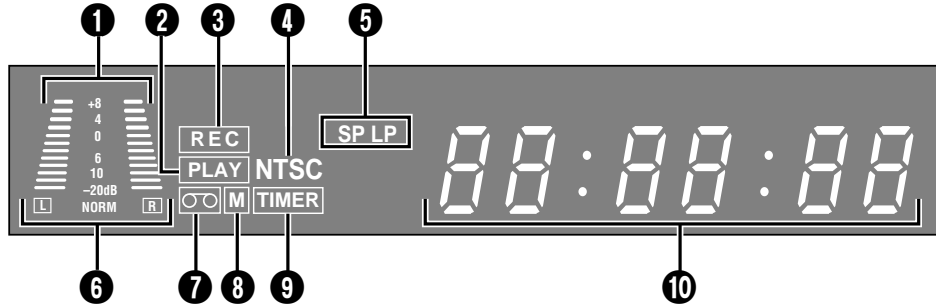

- 1 B.E.S.T. Picture System Display* (pg. 18)
Audio Level Indicator*
- 2 PLAY Indicator (pg. 10)
- 3 REC[ORD] Indicator (pg. 16)
- 4 NTSC Indicator (pg. 24)
- 5 Tape Speed Indicator (pg. 16)
- 6 Audio Mode Indicator* (pg. 15)
- 7 "Cassette Loaded" Mark
- 8 Counter Memory Indicator (pg. 13)
- 9 "TIMER" Indicator (pg. 21)
- 10 Clock/Counter/Channel Display (pg. 6)

* Available with HR-E639EE only.

REAR VIEW

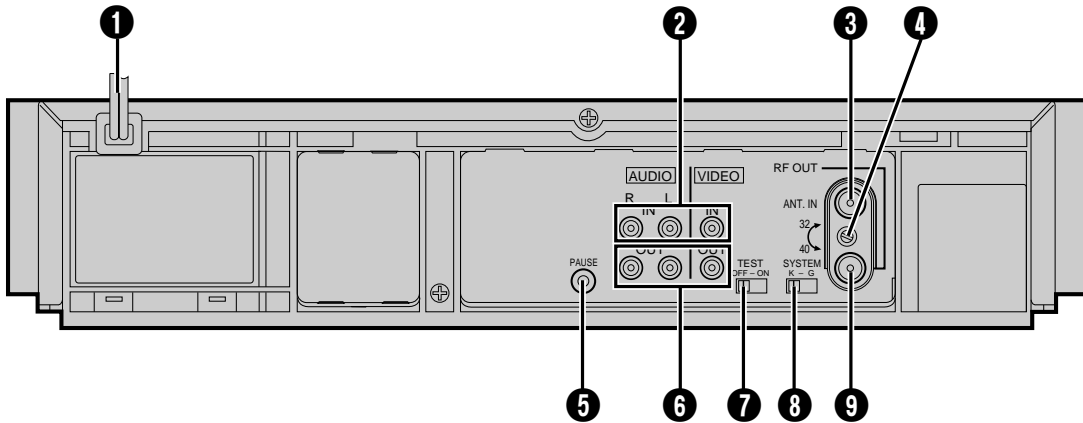

- 1 Mains Power Cord (pg. 3)
- 2 AUDIO and VIDEO IN Connectors (pg. 22)
* The HR-E539EE has only one Audio input connector.
- 3 ANT. IN Connector (pg. 3)
- 4 RF Output Channel Adjustment Screw (pg. 4)
- 5 Remote PAUSE Connector (pg. 23)
- 6 AUDIO and VIDEO OUT Connectors (pg. 3)
* The HR-E539EE has only one Audio output connector.
- 7 TEST Switch (pg. 4)
- 8 SYSTEM Switch (pg. 4)
- 9 RF OUT Connector (pg. 3)

REMOTE CONTROL

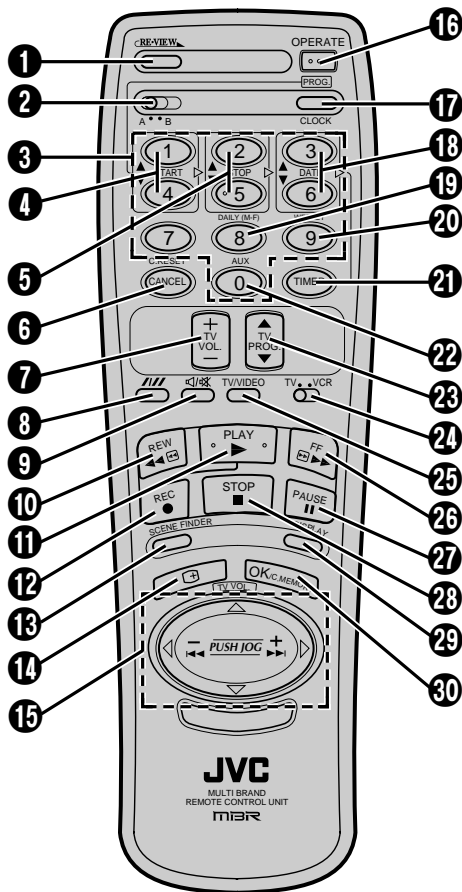

- 1 REVIEW Button (☞ pg. 13)
- 2 A/B CODE Switch (☞ pg. 15)
- 3 NUMBER Keys (☞ pg. 16)
- 4 START ▲/▼ Buttons (☞ pg. 9)
- 5 STOP ▲/▼ Buttons (☞ pg. 9)
- 6 CANCEL Button (☞ pg. 21)
- 7 TV VOL. +/- Button (☞ pg. 26)
- 8 SP/LP/EP Button (☞ pg. 12)
- 9 DIGIT ENTRY Button (☞ pg. 26)
- 10 AUDIO MONITOR Button (☞ pg. 15)
- 11 TV MUTE Button (☞ pg. 26)
- 12 Rewind [REW] Button (☞ pg. 10)
- 13 PLAY Button (☞ pg. 10)
- 14 RECORD Button (☞ pg. 16)
- 15 SCENE FINDER Button (☞ pg. 14)
- 16 OSD (☐) Button (☞ pg. 5)
- 17 PUSH JOG Button (☞ pg. 11)
- 18 OPERATE Button (☞ pg. 4)
- 19 PROG Button (☞ pg. 20)
- 20 CLOCK Button (☞ pg. 9)
- 21 DATE ▲/▼ Buttons (☞ pg. 9)
- 22 DAILY Button (☞ pg. 21)
- 23 WEEKLY Button (☞ pg. 21)
- 24 TIMER Button (☞ pg. 21)
- 25 AUX Button (☞ pg. 22)
- 26 TV PROG. ▲/▼ Buttons (☞ pg. 5)
- 27 TV/VCR Switch (☞ pg. 26)
- 28 TV/VIDEO Button (☞ pg. 26)
- 29 Fast Forward [FF] Button (☞ pg. 10)
- 30 PAUSE Button (☞ pg. 11)
- 31 STOP Button (☞ pg. 10)
- 32 DISPLAY Button (☞ pg. 17)
- 33 OK Button (☞ pg. 5)
- 34 C.MEMORY Button (☞ pg. 13)

Installing Batteries

- 1 Open the battery compartment cover.
- 2 Insert 2 "R6/UM-3"-size batteries (provided) in the correct directions.
- 3 Replace the cover.

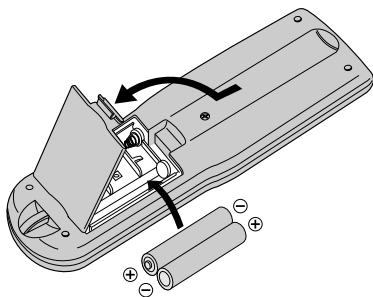

How To Use

The remote control can operate most of your video recorder's functions, as well as basic functions of TV sets of JVC and other brands (☞ pg. 26).

- Point the remote control toward the sensor window.
- The maximum operating distance of the remote control is about 8 m.

NOTE:

If for some reason the remote control doesn't work properly, remove its batteries, wait a short time and then try again.



SPECIFICATIONS

EN 33

GENERAL

Power requirement	
Rating	: AC 110 – 240 V~, 50/60 Hz
Operating	: AC 90 – 260 V~, 50/60 Hz
Power consumption	: 24 W (E639EE) 20 W (E539EE)
Temperature	
Operating	: 5°C to 40°C
Storage	: -20°C to 60°C
Operating position	: Horizontal only
Dimensions (WxHxD)	: 426 x 94 x 341 mm
Weight	: 4.5 kg
Format	: VHS standard
Maximum recording time	
(SP)	: 240 min. with E-240 video cassette (PAL/MESECAM) 160 min. with T-160 video cassette (NTSC)
(LP)	: 480 min. with E-240 video cassette (PAL/MESECAM)
(EP)	: 480 min. with T-160 video cassette (NTSC)

VIDEO/AUDIO

Signal system	: PAL-type colour signal and CCIR monochrome signal, 625 lines 50 fields : NTSC colour and EIA monochrome signals, 525 lines/60 fields
Recording system	: DA-4 (Double Azimuth) head helical scan system
Signal-to-noise ratio	: 45 dB
Horizontal resolution	: 250 lines (PAL/MESECAM) : 220 lines (NTSC)
Frequency range	: 70 Hz to 10,000 Hz (Normal audio) 20 Hz to 20,000 Hz (Hi-Fi audio)[E639EE only]
Input/Output	: RCA connectors (IN x 2, OUT x 1)

TUNER/TIMER

TV channel storage capacity	: 48 positions (+AUX position "AU")
Tuning system	: Voltage synthesized tuner
Channel coverage	: VHF (Low) 42 – 153MHz (High) 153 – 470MHz UHF 470 – 870MHz
Aerial output	: UHF channels (Adjustable E32 – E40)
Memory backup time	: Approx. 18 hours.

ACCESSORIES

Provided accessories	: RF cable, Infrared remote control unit, "R6/UM-3" battery x 2
----------------------	---

Specifications shown are for SP mode unless otherwise specified.

Design and specifications subject to change without notice.

Precautions

Failure to heed the following precautions may result in damage to the recorder, remote control or video cassette.

- DO NOT place the recorder . . .**
 - ... in an environment prone to extreme temperatures or humidity.
 - ... in direct sunlight.
 - ... in a dusty environment.
 - ... in an environment where strong magnetic fields are generated.
 - ... on a surface that is unstable or subject to vibration.
- DO NOT block the recorder's ventilation openings.**
- DO NOT place heavy objects on the recorder or remote control.**
- DO NOT place anything which might spill on top of the recorder or remote control.**
- AVOID violent shocks to the recorder during transport.**

MOISTURE CONDENSATION

Moisture in the air will condense on the recorder when you move it from a cold place to a warm place, or under extremely humid conditions—just as water droplets form in the surface of a glass filled with cold liquid. Moisture condensation on the head drum will cause damage to the tape. In conditions where condensation may occur, keep the recorder turned on for a few hours to let the moisture dry.

ABOUT HEAD CLEANING

Accumulation of dirt and other particles on the video heads may cause the playback picture to become blurred or interrupted. Be sure to contact your nearest JVC dealer if such troubles occur.

HR-E639/539EE

JVC
VICTOR COMPANY OF JAPAN, LIMITED

COPYRIGHT © 1996 VICTOR COMPANY OF JAPAN, LTD.

Printed in Japan
1096YOV*UN*VP

