

COMPACT VHS CAMCORDER

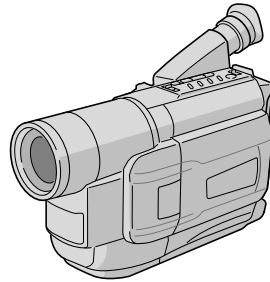

GR-SXM58
 GR-SXM48
 GR-FXM383
 GR-FXM38
 GR-SX24
 GR-FX14



S-VHS VHS
 PAL
 625
Super VHS
Super VHS ET

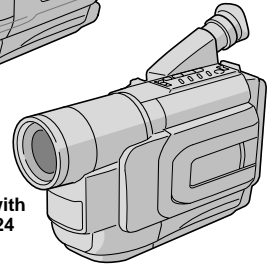

S-VHS is compatible with
 GR-SXM58/SXM48/SX24
 only

EG  Printed in Malaysia
 1001MKV*UN*PJ

COPYRIGHT© 2001 VICTOR COMPANY OF JAPAN, LTD

.....
Dear Customer,

- Thank you for purchasing the JVC Compact VHS camcorder. Before use, please read "PRECAUTIONS" (☞ pg. 3, 4) to ensure safe use of this product.
-

AUTOMATIC DEMONSTRATION

Automatic Demonstration takes place when "DEMO MODE" is set to "ON" (factory-preset).

- Available when the Power Switch **12** is set to "A" or "M".
- Performing any operation during the demonstration stops the demonstration temporarily. If no operation is performed for more than 1 minute after that, the demonstration will resume.
- "DEMO MODE" remains "ON" even if the camcorder power is turned off.
- To cancel Automatic Demonstration, set the Power Switch **12** to "M" and press the MENU Wheel **1** in while the demo is in progress. This takes you directly to the demo mode's Setting Menu (so you will not have to go through the main Menu Screen). Rotate the MENU Wheel **1** to select "OFF" and press it.

NOTES:

- When a tape whose Erase Protection tab is in the position that allows recording is loaded in the camcorder, demonstration is not available.
- If you do not detach the Lens Cap, you cannot see the actual changes of the Automatic Demonstration activated on the LCD monitor* or viewfinder.

* Applicable models only.

PROVIDED ACCESSORIES

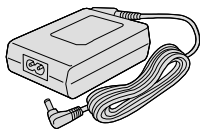

• AC Adapter

AP-V12EG, AP-V11EG or AP-V10EG

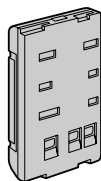
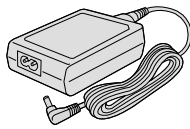

• Battery Pack
BN-V11U
(GR-SXM48/FXM383/
FXM38/SX24/FX14)
BN-V20U
(GR-SXM58)

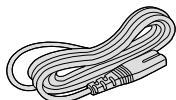

• Power Cord

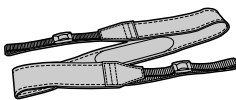

• Shoulder Strap

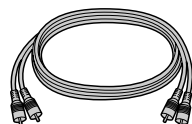

• A/V (Audio/Video)
Cable



• Lens Cap

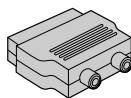

• Cable Adapter

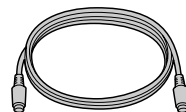

• S-Video Cable
(GR-SXM58/SXM48/
SX24 only)

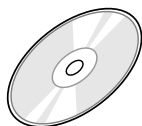

• CD-ROM
(GR-SXM58 only)



• PC Connection Cable
(GR-SXM58 only)

NOTE:

In order to maintain optimum performance of the camcorder, provided cables may be equipped with one or more core filter. If a cable has only one core filter, the end that is closest to the filter should be connected to the camcorder.

PRECAUTIONS

SAFETY PRECAUTIONS

WARNING:

TO PREVENT FIRE OR SHOCK HAZARD, DO NOT EXPOSE THIS UNIT TO RAIN OR MOISTURE.

CAUTIONS

- To prevent shock, do not open the cabinet. No user serviceable parts inside. Refer servicing to qualified personnel.
- When you are not using the AC Adapter for a long period of time, it is recommended that you disconnect the power cord from AC outlet.

NOTES:

- The rating plate (serial number plate) and safety caution are on the bottom and/or the back of the main unit.
- The rating information and safety caution of the AC Adapter are on its bottom.

CAUTIONS

- This camcorder is designed to be used with PAL-type colour television signals. It cannot be used for playback with a television of a different standard. However, live recording and LCD monitor*/viewfinder playback are possible anywhere.
- Use the JVC BN-V11U**/V12U/V20U/V400U battery packs and, to recharge them or to supply power to the camcorder from an AC outlet, use the provided multi-voltage AC Adapter. (An appropriate conversion adapter may be necessary to accommodate different designs of AC outlets in different countries.)

* Applicable models only.

** GR-SXM48/FXM383/FXM38/SX24/FX14 only.

CAUTIONS

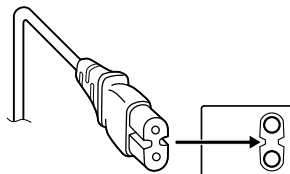

To avoid electric shock or damage to the unit, first firmly insert the small end of the power cord into the AC Adapter until it is no longer wobbly, and then plug the larger end of the power cord into an AC outlet.

Crossed Out Dust Bin Mark

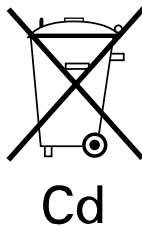

- The Crossed Out Dust Bin Mark on the battery pack indicates that the product complies with Directives 91/157/EEC and 93/86/EEC.
- Nickel-Cadmium (Ni-Cd) battery pack must be recycled or disposed of properly.



Cassettes marked **S-VHS** and **VHS** can be used with this camcorder. However, S-VHS recordings are possible* only with cassettes marked **S-VHS**.

* GR-SXM58/SXM48/SX24 only.

When the equipment is installed in a cabinet or on a shelf, make sure that it has sufficient space on all sides to allow for ventilation (10 cm or more on both sides, on top and at the rear).

Do not block the ventilation holes.

(If the ventilation holes are blocked by a newspaper, or cloth etc. the heat may not be able to get out.)

No naked flame sources, such as lighted candles, should be placed on the apparatus.

When discarding batteries, environmental problems must be considered and the local rules or laws governing the disposal of these batteries must be followed strictly.

The apparatus shall not be exposed to dripping or splashing.

Do not use this equipment in a bathroom or places with water.

Also do not place any containers filled with water or liquids (such as cosmetics or medicines, flower vases, potted plants, cups etc.) on top of this unit.

(If water or liquid is allowed to enter this equipment, fire or electric shock may be caused.)

INDEX

A

AC Adapter	pg. 6
Animation Recording	pg. 21
Auto Date Record	pg. 19
Auto Focus	pg. 18
Auto Shut Off	pg. 11

B

Battery Pack	pg. 6, 26
Blue Filter Effect	pg. 24
Brighten The Image	pg. 18
Brighten The LCD Monitor	pg. 11

C

Cassette Adapter	pg. 16
Charge Marker	pg. 6
Charging The Battery Pack	pg. 6
Classic Film Effect	pg. 24
Clean The Camcorder	pg. 27
Connection To a VCR/TV	pg. 15
Connection To A PC	pg. 16
Counter Memory	pg. 14

D

Darken The Image	pg. 18
Darken The LCD Monitor	pg. 11
Date/Time Display	pg. 19
Date/Time Settings	pg. 7
Demonstration Mode	pg. 1, 22
Digital Effects	pg. 24
Digital Zoom	pg. 20
Dioptr Adjustment	pg. 8

E

Electronic Fog Filter Mode	pg. 24
Erase Protection	pg. 8
Exposure Control	pg. 18

F

Fade-In/Out	pg. 23
Fast-Forward Tape	pg. 11
5-Second Recording Mode	pg. 12

G

Grip Adjustment	pg. 8
-----------------------	-------

H

High Speed Shutter Mode	pg. 24
-------------------------------	--------

I

Instant Titles	pg. 19
----------------------	--------

L

LCD Monitor/Viewfinder, Indications	pg. 9, 10, 17
Load A Tape	pg. 8

M

Manual Focus	pg. 18
Menu Screen	pg. 18 – 22
Monotone Effect	pg. 24
Mosaic Effect	pg. 24

N

ND Effect Mode	pg. 24
Nega/Posi Mode	pg. 24
Night-Scope	pg. 23

P

Picture Stabiliser	pg. 12
Playback	pg. 11
Playback Special Effects	pg. 14
Programme AE with Special Effects	pg. 24
Provided Accessories	pg. 2

Q

Quick Review	pg. 13
--------------------	--------

R

Recording, Advanced Features	pg. 23, 24
Recording, Start/Stop	pg. 11
Recording Format (S-VHS/S-VHS ET)	pg. 20
Recording Mode	pg. 20
Record-Standby	pg. 11
Red Filter Effect	pg. 24
Retake	pg. 13
Rewind The Tape	pg. 11

S

Self-Recording	pg. 11
Sepia Mode	pg. 24
Shoulder Strap Attachment	pg. 8
Snapshot During Playback	pg. 12
Snapshot	pg. 12
Solarisation Effect	pg. 24
Specifications	pg. 28
Sports Mode	pg. 24
Still Playback	pg. 11
Stretch Effect	pg. 24
Strobe Effect	pg. 24
Super LoLux (S.LX)	pg. 19
Super VHS Expansion Technology	pg. 20

T

Tape Counter	pg. 14
Tape Dubbing	pg. 15
Tape Length Setting	pg. 21
Tele Macro	pg. 21
Time Base Corrector	pg. 14
Time-Lapse Shooting	pg. 21
Tracking	pg. 14
Tripod Mounting	pg. 8
Twilight Mode	pg. 24

U

Unload A Tape	pg. 8
---------------------	-------

V

Video Echo Effect	pg. 24
Video Light	pg. 13
Viewfinder Adjustment	pg. 8

W

White Balance Adjustment	pg. 19
Wide Mode	pg. 20
Wipe-In/Out	pg. 23

Z

Zooming	pg. 13
---------------	--------

GETTING STARTED

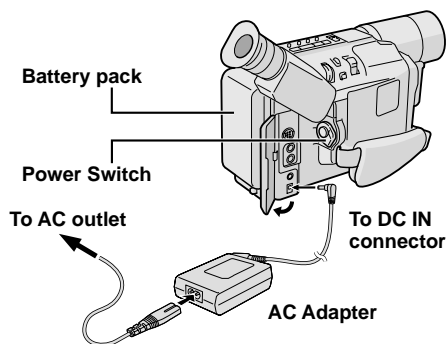
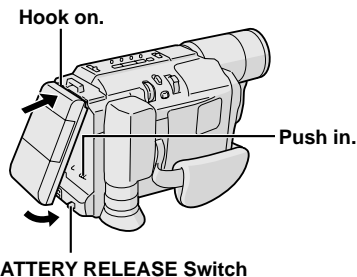

CHARGING THE BATTERY PACK

1) Hook the end of the battery pack to the camcorder and push the battery in until it locks in place.

• If the battery pack is attached in the wrong position, a malfunction may occur.

2) Set the Power Switch ⑫ to "OFF". Connect the AC Adapter to the DC IN connector ⑨, then connect the Power Cord to the AC Adapter.

3) Plug the Power Cord into an AC outlet. The CHARGE lamp ⑮ blinks to indicate charging has started.

4) When the CHARGE lamp ⑮ stops blinking but stays lit, charging is finished. Unplug the AC Adapter from the AC outlet. Disconnect the AC Adapter from the camcorder.

To Detach The Battery Pack . . .

... slide BATTERY RELEASE ⑧ and pull out the battery pack.

Battery pack	Charging time
BN-V11U*	approx. 1 hr. 30 min.
BN-V12U (optional)	approx. 1 hr. 30 min.
BN-V20U** (optional)	approx. 2 hrs. 20 min.
BN-V400U (optional)	approx. 4 hrs. 30 min.

Charging times are for a fully discharged battery pack.

* GR-SXM48/FXM383/FXM38/SX24/FX14 only.

** Provided with GR-SXM58 only.

USING THE BATTERY PACK

Perform step 1) of "CHARGING THE BATTERY PACK".

Approximate recording time (unit: min.)

Battery pack	Viewfinder on		LCD monitor on
	①	②	①
BN-V11U	95 (50)	100 (50)	80 (45)
BN-V12U (optional)	95 (50)	100 (50)	80 (45)
BN-V20U (optional)	150 (85)	165 (90)	135 (75)
BN-V400U (optional)	360 (205)	385 (210)	315 (190)

① When using models equipped with LCD monitor

② When using GR-SX24/FX14

() : when the video light is on

(GR-SXM58/SXM48/FXM383/SX24 only)

USING AC POWER

Connect the AC Adapter to the camcorder (step 2) and 3) of "CHARGING THE BATTERY PACK".

• The provided AC Adapter features automatic voltage selection in the AC range from 110 V to 240 V.

ATTENTION

Before detaching the power source, make sure that the camcorder's power is turned off. Failure to do so can result in a camcorder malfunction.

REFRESH:

Be sure to fully discharge a battery pack before recharging or storing it for a long period of time, otherwise the battery performance will be reduced.

- 1) Perform steps 1) through 3) of "CHARGING THE BATTERY PACK".
- 2) Press REFRESH ⑭ for over 2 seconds. The REFRESH lamp ⑰ blinks to indicate discharging has started.
- 3) When discharging is finished, charging automatically starts and the CHARGE lamp ⑮ blinks.

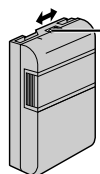

Charge marker helps you remember whether the battery pack has been charged or not. Two colours are provided (red and black)—you choose which one means charged and which means discharged.

- During charging or discharging, the camcorder cannot be operated.
- Charging and discharging is not possible if the wrong type of battery is used.
- When charging the battery pack for the first time or after a long storage period, the CHARGE lamp **B** may not light. Remove the battery pack from the camcorder, then try charging again.
- If a fully-charged battery's operation time remains extremely short, the battery is worn out. Please purchase a new one.
- Perform charging where the temperature is between 10°C and 35°C. 20°C to 25°C is the ideal temperature range for charging. If the environment is too cold, charging may be incomplete.
- Charging time varies according to the ambient temperature and the status of the battery pack.
- Since the AC Adapter processes electricity internally, it becomes warm during use. Be sure to use it only in well-ventilated areas.
- The following operation stops charging or discharging:
 - Set the Power Switch **12** to "PLAY", "A" or "M".
 - Disconnect the AC Adapter from the camcorder.
 - Unplug the AC Adapter's power cord from the AC outlet.
 - Detach the battery from the camcorder.
- Using the optional AA-V15EG AC Power Adapter/Charger, you can charge the BN-V11U/V12U/V20U/V400U battery pack without the camcorder. However, it cannot be used as an AC adapter.
- To avoid interference with reception, do not use the AC Adapter near a radio.
- Recording time is reduced significantly when Zoom or Record-Standby mode is engaged repeatedly or the LCD monitor* is used repeatedly.
- Before extended use, it is recommended that you prepare enough battery packs to cover 3 times the planned shooting time.

* Applicable models only.

Date/Time Settings

- 1) Set the Power Switch **12** to "M".
- 2) Press the MENU Wheel **1** in. The Menu Screen appears.
 - You can select the language (ENGLISH or RUSSIAN) of messages in menu screens (☞ pg. 18, 22 "MENU LANG." in SYSTEM MENU).
- 3) Rotate the MENU Wheel **1** to select "►TO SYSTEM MENU" and press it to display SYSTEM MENU. Rotate the MENU Wheel **1** to select "►NEXT" and press it to display the next page.
- 4) Rotate the MENU Wheel **1** to select "DATE/TIME" and press it. The DATE/TIME Menu appears.
- 5) To set "YEAR", "MONTH", "DAY" or "TIME" (hour/minute), rotate the MENU Wheel **1** to select the desired item, and press it. When the setting begins blinking, rotate the MENU Wheel **1** until the correct setting appears and then press it. The setting stops blinking.
- 6) When none of these settings ("YEAR", "MONTH", "DAY", "TIME") blinks, rotate the MENU Wheel **1** to select "EXIT", and press it. The Menu Screen reappears with the highlight bar on "►RETURN".
- 7) Press the MENU Wheel **1** in to close the Menu Screen.
 - To display the date and time in the camcorder's display and on a connected TV, see DATE/TIME DISP. (☞ pg. 19) in CAMERA MENU.
 - The date/time cannot be stored in memory if the built-in clock battery runs out. Consult an authorised JVC dealer for replacement, or set the date/time as necessary before you start shooting.

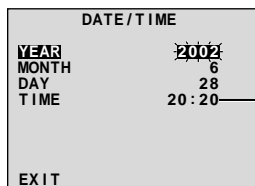
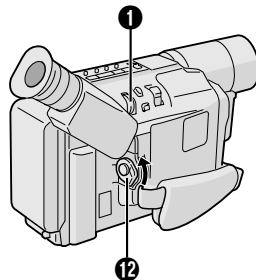

24-hour indication

Grip Adjustment

- 1) Separate the Velcro strip.
- 2) Pass your right hand through the loop and grasp the grip.
- 3) Adjust so that your thumb and fingers can easily operate the Recording Start/Stop Button **11** and Power Zoom Lever **4**. Refasten the Velcro strip.

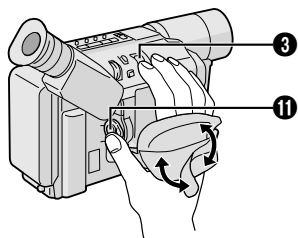

Viewfinder Adjustment

- 1) Set the Power Switch **12** to "A" or "M".
- 2) Turn the Dioptre Adjustment Control **29** until the indications in the viewfinder are clearly focused.

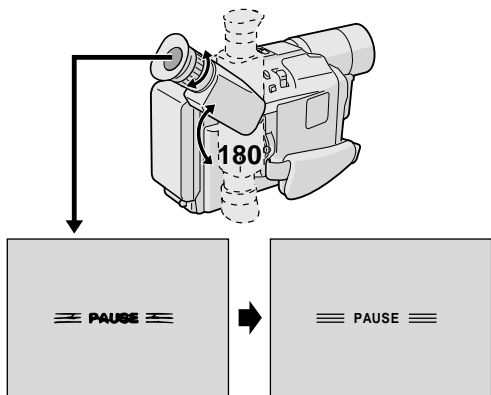

Shoulder Strap Attachment

Thread the strap through the eyelet **26**, then fold it back and thread it through the buckle. Repeat the procedure to attach the other end of the strap to the other eyelet **26**, making sure the strap is not twisted. Adjust the length.

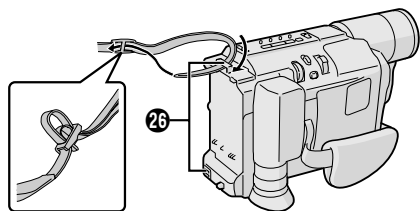

Tripod Mounting

Align the screw and camera direction stud on the tripod with the tripod mounting socket **42**. Then tighten the screw.

CAUTION

When using a tripod, be sure to open and extend its legs fully to stabilise the camcorder. To prevent damage to the unit caused by falling over, do not use a small-sized tripod.

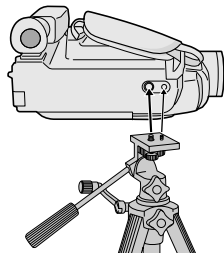

Loading/Unloading A Cassette

- 1) Open the LCD monitor fully*. Slide EJECT **25** until the cassette holder opens. Do not use force to open.
 - 2) Insert or remove a cassette. When inserting, make sure the label is facing outward. **53** appears when a cassette is loaded.
 - 3) Press the Close button **28** to close the cassette holder until it locks into place. Close the LCD monitor*.
- Closing the LCD monitor while the cassette holder is still open may cause damage to the LCD monitor*.
 - Make sure the erase protection tab is in the position that allows recording. If not, slide the tab. Some cassettes have removable tabs. If the tab has been removed, cover the hole with adhesive tape.
 - The cassette holder cannot be opened while the camcorder is in the record mode or detached from the power source.

* Applicable models only.

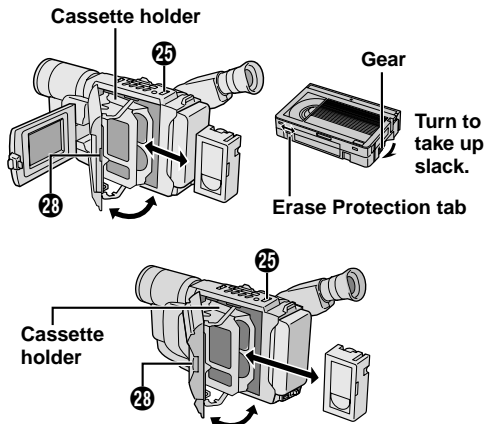

CONTROLS, CONNECTORS AND INDICATORS

Refer to this diagram while reading the instructions.

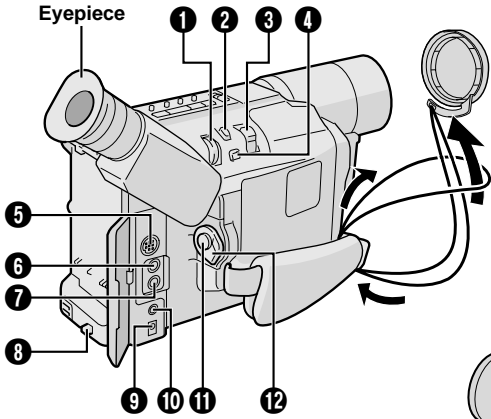

During shooting

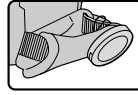

Keep the lens cap attached to the camcorder.

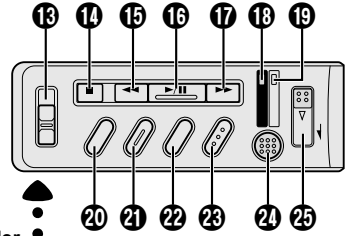

Cassette holder

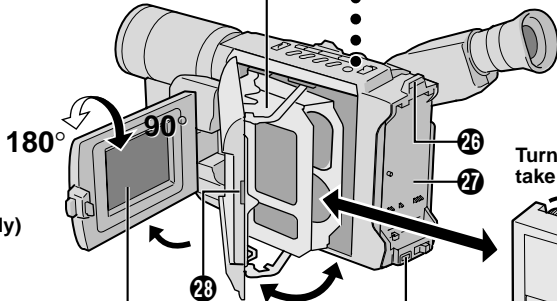

Turn the gear to take up slack.

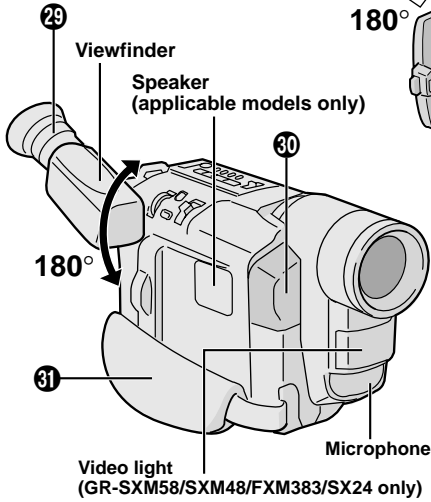
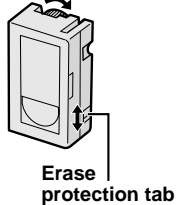

LCD monitor (applicable models only)

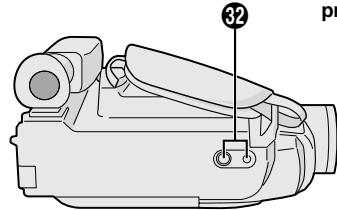

LCD Monitor/Viewfinder Indications

During Recording

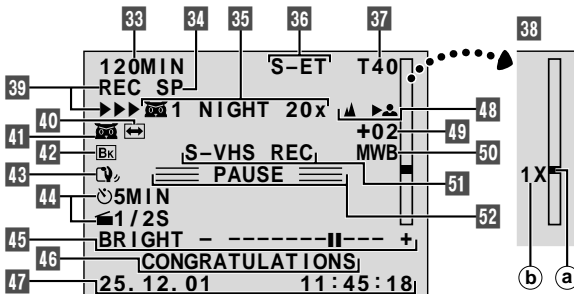

During Playback

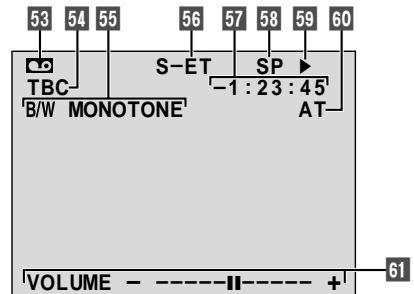

pg. 25 for **Warning Indications**.

1	• MENU Wheel [-, +]	pg. 18	33	Tape Remaining Time	pg. 21
	• BRIGHT Wheel [-, +]*1	pg. 11	34	Recording Mode Indicator	pg. 20
	• TRACKING Wheel [-, +]	pg. 14	35	• Digital Effect Indicator	pg. 24
2	• Snapshot Button [SNAPSHOT]*2	pg. 12		• Programme AE Indicator	pg. 24
	• 5-Second Recording Button			• Night-Scope Indicator*2	pg. 23
	[5 SEC. REC]*3	pg. 12		• Fade/Wipe-Standby Indicator	pg. 23
3	• Power Zoom Lever [T/W]	pg. 13	36	Recording Format Indicator (S/S-ET)*2 ...	pg. 20
	• Speaker Volume Control [VOL.]*1	pg. 11	37	Tape Length Indicator	pg. 21
4	• Picture Stabiliser Button		38	Zoom Indicator Bar	pg. 13
	[P.STABILIZER]	pg. 12		a) Zoom Level Indicator	
	• Time Base Corrector Button [TBC]	pg. 14		b) Approximate Zoom Ratio	
5	S-Video Output Connectors [S]*2	pg. 15	39	Recording Indicator	pg. 11
6	Audio Output Connector [A]	pg. 15	40	Digital Effect Indicator	pg. 24
7	Video Output Connector [V]	pg. 15	41	• Programme AE Indicator	pg. 24
8	Battery Release Switch			• Night-Scope Indicator*2	pg. 23
	[BATTERY RELEASE]	pg. 6	42	Fade/Wipe-Standby Indicator	pg. 23
9	DC IN Connector	pg. 6	43	Picture Stabiliser Indicator	pg. 12
10	Digital Connector [DIGITAL]*4		44	• Interval Time/Recording Time Indicator ...	pg. 21
11	Recording Start/Stop Button	pg. 11		• 5 Sec. Rec Mode Indicator*3	pg. 12
12	Power Switch [PLAY, OFF, A, M]	pg. 11	45	Bright Level Indicator*1	pg. 11
13	Video Light Switch		46	Instant Title Display	pg. 19
	[LIGHT OFF/AUTO/ON]*5	pg. 13	47	Date/Time Display	pg. 19
14	Stop Button [STOP]	pg. 11	48	Focus Indicator	pg. 18
15	• Retake Rewind Button [RETAKE R]	pg. 13	49	Exposure Control Level Counter	pg. 18
	• Quick Review Button [Q R]	pg. 13	50	White Balance Mode Indicator	pg. 19
	• Rewind Button [R]	pg. 11	51	S-VHS/S-VHS ET Recording	
16	Play/Pause Button	pg. 11		Indicator*2	pg. 20
17	• Retake Forward Button [RETAKE F]	pg. 13	52	Record-Standby Mode Indicator	pg. 11
	• Fast-Forward Button [F]	pg. 11	53	 : Cassette Indicator	pg. 8
18	CHARGE Lamp	pg. 6	54	TBC Indicator	pg. 14
19	REFRESH Lamp	pg. 6	55	Playback Special Effect Indicator*2	pg. 14
20	• Fade/Wipe Button [FADE/WIPE]	pg. 23	56	Recording Format Indicator (S/S-ET)*2 ...	pg. 20
	• Counter Reset/Memory Button		57	Tape Counter	pg. 14
	[COUNTER R/M]	pg. 14	58	Recording Mode Indicator (SP/LP)	pg. 20
21	Programme AE Button [P.AE]	pg. 24	59	Tape Running Indicator	
22	Digital Effect Button [DIGIFECT]	pg. 24		▶ : Playback	
23	NIGHT-SCOPE Button*2	pg. 23		▶▶ : Fast-Forward/Shuttle Search	
24	REFRESH Button	pg. 6		◀◀ : Rewind/Shuttle Search	
25	EJECT Switch	pg. 8		: Pause	
26	Shoulder Strap Eyelets	pg. 8	60	Tracking Indicator	pg. 14
27	Battery Pack Mount	pg. 6	61	• BRIGHT: Bright Level Indicator*1	pg. 11
28	Close Button	pg. 8		• VOLUME: Speaker Volume Indicator*1 ...	pg. 11
29	Dioptre Adjustment Control	pg. 8			
30	Camera Sensor				
	Be careful not to cover this area; a sensor				
	necessary for shooting is built-in here.				
31	Grip Strap	pg. 8			
32	Tripod Mounting Socket	pg. 8			

*1 Applicable models only.

*2 GR-SXM58/SXM48/SX24 only.

*3 GR-FXM383/FXM38/FX14 only.

*4 GR-SXM58 only.

*5 GR-SXM58/SXM48/FXM383/SX24 only.

RECORDING

Set REC MODE, S-VHS (S-VHS ET)**, TAPE LENGTH and DATE/TIME in SYSTEM MENU. (☞ pg. 18 – 22, “MENU SETTINGS”)

1 Remove the lens cap. Set the Power Switch ⑫ to “**A**” or “**M**”.

Shooting while using the viewfinder: Make sure the LCD monitor* is closed and locked.

Shooting while using the LCD monitor*: Make sure the LCD monitor* is fully open.

The camcorder enters the Record-Standby mode and “PAUSE” ⑤② is displayed.

- If you tilt the LCD monitor* upward to 180 degrees, the viewfinder switches back on and the monitored image can be viewed both on the LCD monitor* and in the viewfinder, so the person you shoot can view himself/herself.

2 Press the Recording Start/Stop Button ①. REC ③⑨ appears while recording is in progress.

- To stop recording, press the Recording Start/Stop Button ①. The camcorder re-enters the Record-Standby mode.

To Adjust The Brightness Of The LCD Monitor*, rotate the BRIGHT Wheel ① until the bright level indicator ④⑤ on the display moves and the appropriate brightness is reached.

* Applicable models only.

** GR-SXM58/SXM48/SX24 only.

PLAYBACK

1 Load a tape (☞ pg. 8, “Loading/Unloading A Cassette”).

2 Set the Power Switch ⑫ to “**PLAY**”. To start playback, press ▶/II ⑬.

To stop playback temporarily (Still Playback), press ▶/II ⑬.

To stop playback, press ■ ⑭. Press ◀◀ ⑮ to rewind, or ▶▶ ⑰ to fast-forward the tape.

High-speed picture search (Shuttle Search) is possible by pressing ◀◀ ⑮ or ▶▶ ⑰ during playback (holding ◀◀ ⑮ or ▶▶ ⑰ down during playback continues search until released). To resume normal playback, press ▶/II ⑬.

For VIDEO RECORDING/VIDEO PLAYBACK

- The camcorder shuts off automatically after about 5 minutes in the Record-Standby or Stop mode. To turn on again, set the Power Switch ⑫ to “OFF”, then to “**A**”, “**M**” or “**PLAY**”.
- When the Power Switch ⑫ is set to “**A**”, “**M**” or “**PLAY**” and the LCD monitor* is opened at an angle of 60 degrees or more, the LCD monitor* switches on and the viewfinder switches off automatically to save power.
- The playback picture can be viewed in the viewfinder (with the LCD monitor* shut), on the LCD monitor* or on a connected TV (☞ pg. 15, “Connections To A TV/VCR”).
- To remove the indications, ☞ pg. 21, DISPLAY or OSD OUTPUT in SYSTEM MENU.
- To control the speaker* volume, slide VOL. ③ towards “+” to turn up, or towards “-” to turn down. While shooting, sound is not heard from the speaker*.
- If TBC (☞ pg. 14) is engaged during Still Playback, noise bars will not appear (GR-SXM58/SXM48/SX24 only).

* Applicable models only.

BASIC FEATURES

Snapshot (GR-SXM58/SXM48/SX24 only)

You can record still images that look like photographs onto a tape.

1) Perform step 1 of "RECORDING" (ℳ pg. 11).

2) Press **SNAPSHOT** **2**.

- There is a momentary camera shutter-type blackout together with the sound effect of a shutter closing.
- Snapshot is also available during playback. However, the shutter sound is not heard.

Picture Stabiliser

To compensate for unstable images caused by camera-shake, particularly at high magnification.

1) Press **P. STABILIZER** **4**. **ℳ**, **43** appears.

2) To switch off the Picture Stabiliser, press **P. STABILIZER** **4**. **ℳ**, **43** disappears.

- Accurate stabilisation may not be possible in certain conditions including excessive hand shake.
- **ℳ**, **43** appears blinking if the Stabiliser cannot be used.
- This function cannot be activated during the "Night-Scope", "CLASSIC FILM", "STROBE" and "VIDEO ECHO" modes (ℳ pg. 24, "Digital Effects").

5Sec. Rec (5-sec. Recording)

(GR-FXM383/FXM38/FX14 only)

To record a scene for 5 seconds, providing quick scene transitions like those seen in TV programmes.

1) Make sure the recording mode is set to "SP".

2) During Record-Standby, press **5SEC. REC** **2**. **5S 44** appears and 5Sec. Rec is reserved.

3) Press the Recording Start/Stop Button **11**. Recording starts, and after 5-second recording is finished, the camcorder reenters the Record-Standby mode automatically.

4) To cancel the 5Sec. Rec. function, press **5SEC. REC** **2** again so that **5S 44** disappears.

- Fade/Wipe (ℳ pg. 23) cannot be activated by pressing **5SEC. REC** **2**.

Zooming

To produce the zoom in/out effect. Digital circuitry extends the maximum magnification offered by optical zoom. This system is called Digital Zoom.

- Slide the Power Zoom Lever **3** towards "T" to zoom in, or "W" to zoom out.
- The further you slide the Power Zoom Lever **3**, the quicker the zoom action.
- Focusing may become unstable during Zooming. In this case, set the zoom while in Record–Standby, lock the focus by using the manual focus (☞ pg. 18, FOCUS in CAMERA MENU), then zoom in or out in Record mode.
- The zoom level indicator **38**-**ⓐ** moves during zoom. Once the zoom level indicator **38**-**ⓐ** reaches the top, all magnification from that point is through digital processing.
- When using Digital Zoom, the quality of image may suffer. To deactivate Digital Zoom, set "D.ZOOM" (☞ pg. 20) to "OFF" in SYSTEM MENU.
- Digital zoom cannot be used when the "VIDEO ECHO" mode (☞ pg. 24, "Digital Effects") is activated.

Video Light (GR-SXM58/SXM48/FXM383/SX24 only)



To brighten the scene when natural lighting is too dim.

Set LIGHT OFF/AUTO/ON **13** as required:

OFF : Turns off the light.

AUTO: Automatically turns on the light when the camcorder senses insufficient lighting on the subject.

ON : Always keeps the light on as long as the camcorder is turned on.

- It is recommended to set M.W.B. (☞ pg. 19) to  in CAMERA MENU when you use the video light.
- Even if the battery indicator () does not blink if the battery pack's charge is low, the camcorder may turn off automatically when you turn on the video light, or when you start recording with the video light turned on.
- When LIGHT OFF/AUTO/ON **13** is set to "AUTO":
 - Depending on the lighting conditions, the video light may keep turning on and off. Set LIGHT OFF/AUTO/ON **13** to ON or OFF as required.
 - While the "Sports" or "High Speed Shutter" mode is engaged, the light is likely to stay on. While the "Twilight" mode is engaged, the light will not activate. (☞ pg. 24, "Programme AE with Special Effects")

DANGER

- The video light can become extremely hot.
Do not touch it either while in operation or soon after turning it off, otherwise serious injury may result.
- Do not place the camcorder into the carrying case immediately after using the video light, since it remains extremely hot for some time.
- When operating, keep a distance of about 30 cm between the video light and people or objects.
- Do not use near flammable or explosive materials.
- It is recommended that you consult your nearest JVC dealer for replacing the video light.



Quick Review

To check the end of the last recording.

- 1) Make sure the camcorder is in the Record–Standby mode.
 - 2) Press **◀ 15** and release quickly.
Tape is rewound for approx. 1 second and played back automatically, then pauses in Record–Standby mode for the next shot.
- Distortion may occur at the start of playback. This is normal.

Retake

To re-record certain segments.

- 1) Make sure the camcorder is in the Record–Standby mode.
 - 2) Press and hold either RETAKE **15** or **17** to reach the start point for new recording. Pressing **▶▶ 17** forwards the tape and pressing **◀◀ 15** reverses it.
 - 3) Press the Recording Start/Stop Button **11** to start recording.
- Noise bars appear and pictures may become monochrome or darken during Retake. This is normal.

Tracking

Eliminates noise bars that appear on-screen during playback. To activate Manual Tracking:

- 1) Press the TRACKING Wheel **1** for approx. 2 seconds. "MT" **60** appears.
 - 2) Rotate the TRACKING Wheel **1** so that the noise bars disappear.
- To return to Auto Tracking, press the TRACKING Wheel **1** for approx. 2 seconds or set the Power Switch **12** to "OFF" and then "**PLAY**" again. "AT" **60** blinks. When Auto Tracking finishes, the indication disappears.
 - When noise bars appear during playback, the camcorder enters the Auto Tracking mode and "AT" **60** appears.
 - Manual Tracking may not work with tapes recorded on other VCRs or camcorders.

TBC (Time Base Corrector)

Removes jitter from fluctuating video signals to deliver a stable picture even with old tapes.

To activate/release the TBC mode, press TBC **4** during playback for more than 1 second. When the TBC mode is activated, "TBC" **54** is displayed.

- The "TBC" indicator **54** turns green (grey with a camcorder equipped with a black/white viewfinder) while TBC is working, and white while TBC is not operative.
- TBC does not work during Still Playback and Shuttle Search (**13** pg. 11).
- It may take a few seconds before TBC actually starts working.
- The picture may be distorted if the TBC mode is activated or deactivated at the edit-in/-out points or when normal playback resumes after Still Playback or Shuttle Search (**13** pg. 11).
- If the playback picture is distorted when TBC is set to on, turn off TBC.

Counter Memory

Makes it easier to locate a specific tape segment.

- 1) Press COUNTER R/M **20** and hold for more than 1 second. The counter **57** resets to "0:00:00".
 - 2) Press COUNTER R/M **20** for less than 1 second. "M" appears.
 - 3) After recording or playback, press **14**, then **15**. The tape automatically stops at or close to 0:00:00.
 - 4) Press **16** to start playback.
- The counter memory functions in the Fast-Forward and Rewind modes.
 - To disable the counter memory function, press COUNTER R/M **20** for less than 1 second so that "M" disappears.

Playback Special Effects

(GR-SXM58/SXM48/SX24 only)

Allows you to add creative effects to the playback image. (**13** pg. 24, "Digital Effects")

- 1) Activate "TBC" and Auto "Tracking".
 - 2) Press DIGIFECT **22** repeatedly until the desired mode **55** appears.
- To cancel the effect, select "OFF".
 - NEGA POSI, MOSAIC and STRETCH are not available.
 - Playback Special Effects do not work during Shuttle Search (**13** pg. 11).
 - The selected effect mode cannot be changed during Still Playback (**13** pg. 11).

Connections To A TV/VCR

- 1) Make sure all units are turned off.
 - 2) Connect the camcorder to a TV or VCR. If using both TV and VCR, connect the VCR output to the TV input.
 - 3) Turn on all units. Set the VCR to its AUX input mode, and set the TV to its VIDEO mode.
- Use the AC Adapter as the power supply.
 - Be sure to adjust the TV sound volume to its minimum level to avoid a sudden burst of sound when the camcorder is turned on.
 - If you have a TV or speakers that are not specially shielded, do not place the speakers adjacent to the TV as interference will occur in the camcorder playback picture.
 - If your TV/VCR has a 21-pin connector, use the provided Cable Adapter.
 - The S-Video cable connection can improve the dubbed picture quality. If your TV/VCR has a 21-pin connector, use a commercially available cable adapter with an S-Video connector (GR-SXM58/SXM48/SX24 only).

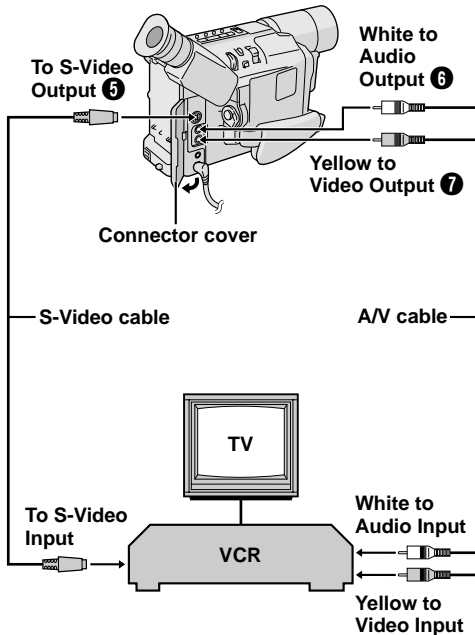

Tape Dubbing

- 1) Connect the camcorder and the VCR (☞ "Connections To A TV/VCR"). Set the Power Switch (12) to "PLAY", turn on the VCR's power, and insert the appropriate cassettes in the camcorder and the VCR. Engage the VCR's AUX and Record-Pause modes.
 - 2) Press ►/|| (16) to find a spot just before the edit-in point. Once it is reached, press ►/|| (16) again.
 - 3) Press ►/|| (16) and engage the VCR's Record mode.
 - 4) Engage the VCR's Record-Pause mode and press ►/|| (16).
- Repeat steps 2) through 4) for additional editing, then stop the VCR and camcorder when finished.

Using The Cassette Adapter (optional)

Use this to play back an S-VHS-C/VHS-C video cassette recorded with this camcorder on a S-VHS/VHS VCR.

- 1) Slide the battery cover up to remove it, install one "AA (R6)" size battery, then reattach the cover.
 - 2) Slide the latch to open the compartment door, then insert the cassette and close the compartment door.
 - 3) Load the cassette adapter into the VCR and play the tape back.
 - 4) Slide the latch and the compartment door opens automatically. This may take around 10 seconds. Do not attempt to force the adapter open. Then, insert your finger in the hole, and push up and remove the cassette.
- During tape loading and unloading, do not touch the reels for safety and tape protection.
 - Tapes recorded in S-VHS or S-VHS ET mode cannot be played back on a regular VHS VCR. Playback is possible with a VCR equipped with the S-VHS function.
(GR-SXM58/SXM48/SX24 only)
 - During special-effect playback (slow motion, still frame, etc.), the picture may vibrate or noise bars may appear on the screen.
 - To record on a VCR using a compact cassette and the adapter, cover the adapter's recording safety hole with adhesive tape.

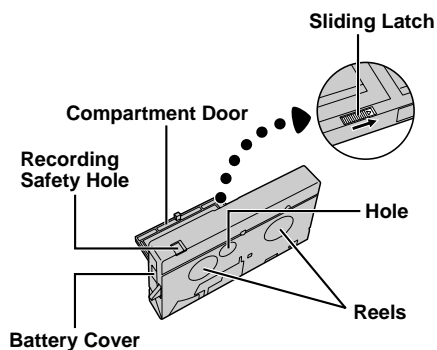

Connection To A Personal Computer (GR-SXM58 only)

You can transfer image data from the camcorder to a PC using Digital Photo Navigator. When connecting to your PC, refer to the instruction manuals of the PC and Setup Guide for the provided software.

When connecting to a Macintosh . . .

The optional KEYSpan USA-19 USB PDA Adapter is required.

- Macintosh is a registered trademark of Apple Computer, Inc.
- Keyspan is a trademark of InnoSys Inc.

INSTRUCTIONS

Refer to this diagram while reading the instructions.

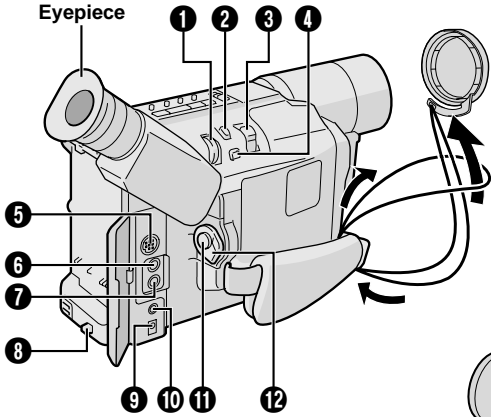

During shooting

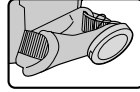

Keep the lens cap attached to the camcorder.

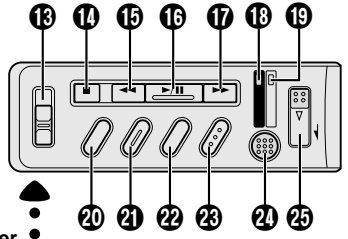

Cassette holder

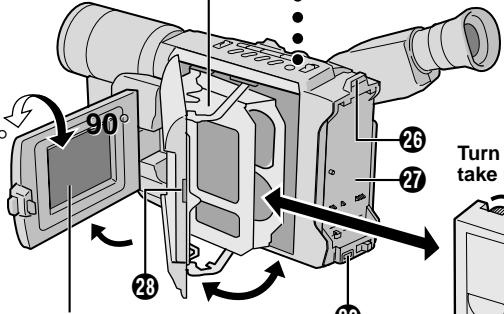

Turn the gear to take up slack.

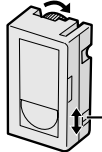

Erase protection tab

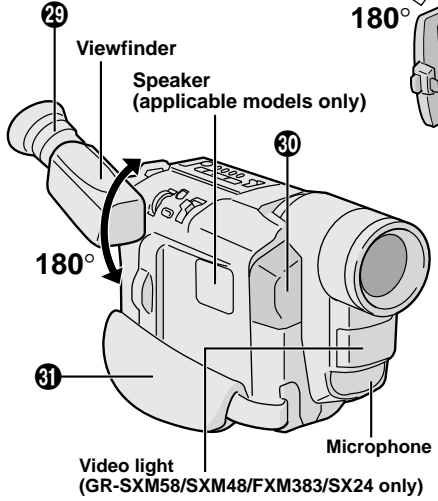

Video light (GR-SXM58/SXM48/FXM383/SX24 only)

LCD Monitor/Viewfinder Indications

During Recording

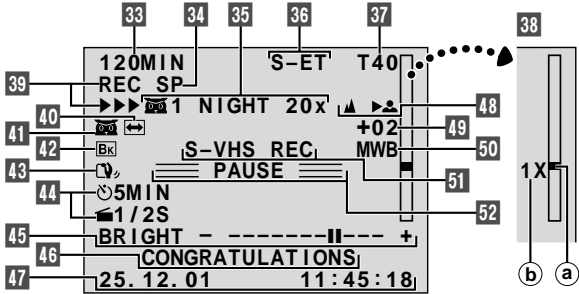

During Playback

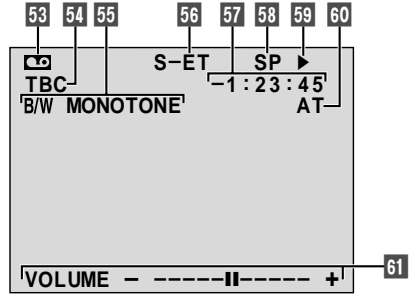

pg. 25 for **Warning Indications**

MENU SETTINGS

- 1 Set the Power Switch **12** to "M".
- 2 Press the MENU Wheel **1** in. The Menu Screen appears. Rotate the MENU Wheel **1** to select the desired function.
 - To go from CAMERA MENU to SYSTEM MENU, rotate the MENU Wheel **1** to select "▶TO SYSTEM MENU" and press it. SYSTEM MENU is composed of 2 pages. To go to the next page, rotate the MENU Wheel **1** to select "▶NEXT" and press it.
 - To return to CAMERA MENU from page 2 of SYSTEM MENU, rotate the MENU Wheel **1** to select "▶TO CAMERA MENU" and press it.

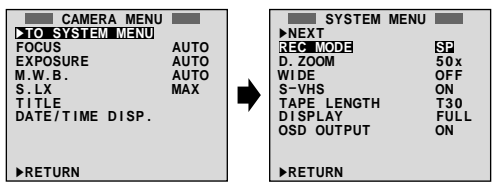

- 3 Press the MENU Wheel **1** in to display the Setting Menu and rotate it to select the desired setting.
- 4 Press the MENU Wheel **1** in. The Menu Screen reappears with the highlight bar on "▶RETURN". Press the MENU Wheel **1** in. The normal screen reappears.

CAMERA MENU

FOCUS

If correct focus cannot be obtained with AUTO FOCUS, set to MANU to use manual focusing. "▲▲" appears.

To focus on a farther subject, rotate the MENU Wheel **1** upward. "◀" appears and blinks.
To focus on a nearer subject, rotate the MENU Wheel **1** downward. "▶" appears and blinking.

- If the lens is smeared or blurred, accurate focusing is not possible.
- When shooting a subject close to the lens, zoom out first (☞ pg. 13, "Zooming"). If zoomed in in the auto focus mode, the camcorder could automatically zoom out depending on the distance between the camcorder and the subject. This does not occur with "TELE MACRO" (☞ pg. 21) in SYSTEM MENU.

- Be sure to focus the lens in the maximum telephoto position when you use the Manual Focus mode. If you focus in on a certain subject in the wide-angle position, sharply focused images cannot be obtained when zoomed in because the depth-of-field is reduced at longer focal lengths.
- When the focus level cannot be adjusted any farther or closer, "▲" or "▲" will blink.

EXPOSURE

Manual exposure adjustment is recommended in the following situations:

- When shooting using reverse lighting or when the background is too bright.
- When shooting on a reflective natural background such as at the beach or when skiing.
- When the background is overly dark or the subject light.

To brighten the image, rotate the MENU Wheel **1** downward.

To darken the image, rotate the MENU Wheel **1** upward.

The exposure control level increases/decreases (maximum ±06).

M.W.B.



If the white balance is correct, all other colours will be accurately reproduced.

AUTO : White balance is adjusted automatically.

 **FINE** : Outdoors on a sunny day.

 **CLOUD** : Outdoors on a cloudy day.

 **HALOGEN** : A video light or similar type of lighting is used.

MWB: White balance is set manually. Hold a sheet of plain white paper in front of the subject. Adjust zoom or position yourself so that the white paper fills the screen. If it is difficult to focus on the white paper, adjust focus manually ( FOCUS in CAMERA MENU). Press the MENU Wheel  in until "MWB" begins blinking. When the setting is completed, "MWB" stops blinking.

- Once you adjust white balance manually, the setting is retained even if the power is turned off or the battery removed.

- White balance cannot be used when the "SEPIA" or "MONOTONE" mode ( pg. 24, "Digital Effects") is activated.

S.LX

MAX: To record a subject in a darkly lit environment, when it is more convenient to shoot the subject with a brighter image even if the picture becomes slightly coarse.

NORMAL: To record a subject in a dimly lit environment, when it is more convenient to shoot with a less coarse picture although the subject becomes slightly dark.

OFF: Allows you to shoot dark scenes with no picture brightness adjustment.

TITLE

Allows you to superimpose one of eight preset titles in 2 different languages. Change the language in TITLE LANG. ( pg. 22) in SYSTEM MENU.

-  shows the selected title which remains until OFF is selected.

DATE/TIME DISP.

Makes the date/time appear in the camcorder or on a connected monitor (set DATE/TIME in SYSTEM MENU first  pg. 7).

- The selected display will be recorded. If you do not want to record the display, select OFF before shooting.

- In the AUTO DATE mode, the camcorder records the date for about 5 seconds when recording is initiated after the date is changed, a cassette is loaded, or AUTO DATE is selected. The date is replaced after 5 seconds with "AUTO DATE" but this is not recorded.

SYSTEM MENU

This Menu Screen cannot be accessed while recording.

REC MODE

Allows you to set the recording mode. "LP" (Long Play) is more economical, providing twice the recording time.

- If the recording mode is switched during recording, the playback picture will be blurred at the switching point.

D. ZOOM

Zooming is possible from 16X (the optical zoom limit), to a maximum of 50X or 700X digital magnification.

When set to "OFF" only optical zoom (maximum 16x magnification) can function.

WIDE

When set to "ON" black bars will be recorded at the top and bottom of the screen to produce a cinema-like "wide-screen" effect. Not effective with "Snapshot" (GR-SXM58/SXM48/SX24 only,  pg. 12).

S-VHS (S-VHS ET)

(GR-SXM58/SXM48/SX24 only)

ON: With an S-VHS cassette, "S" appears and the camcorder records in S-VHS.

With a VHS cassette, "S-ET" appears and the camcorder records with S-VHS picture quality, which is called Super VHS ET (Expansion Technology). S-VHS REC appears during recording.

OFF: Records in VHS on a VHS or S-VHS cassette.

- JVC EHG (Extra High Grade) tapes are recommended for superior results.
Use S-VHS tape for storing recordings for an extended period or for recording important scenes, as it enables higher-quality recording and playback.
- With some tapes, better picture quality may not be obtained even with S-VHS ET recording. It is recommended that you do test record beforehand to make sure whether better results can be obtained.
- If the S-VHS ET mode or recording format is switched during recording, the playback picture will be blurred at the switching point.
- It is recommended that tapes recorded on this camcorder be played back on this camcorder.
- Tapes recorded in S-VHS or S-VHS ET mode can be played back not only on this camcorder but also on a Super VHS VCR.
 - Tapes recorded in S-VHS ET mode cannot be played back on some VCRs, including some JVC VCRs.

- Tapes recorded in S-VHS or S-VHS ET mode cannot be played back correctly on a normal VHS VCR.
- S-VHS ET does not work with S-VHS tapes.
- To avoid on-screen noise, do not perform Still Playback or Shuttle Search repeatedly.
- If the picture contains a lot of jitter or noise, use a cleaning cassette.



TAPE LENGTH

Allows you to set the tape length depending on the tape used: T30=30 minutes, T45=45 minutes, T50=50 minutes, T60=60 minutes.

- Tape remaining time  is correct only if the correct tape length has been selected.

DISPLAY

FULL: Makes all of the indications appear on the LCD monitor*/viewfinder during playback or recording.

SIMPLE: Makes the following indications disappear from the LCD monitor*/viewfinder during recording or playback: , tape remaining time, , tape length ( pg. 9, 17).

* Applicable models only.

OSD OUTPUT

ON: On-screen indications are displayed.

OFF: On-screen indications are turned off except Date/Time, Instant Title and Warning Indication.

REC TIME

You can shoot a series of pictures, each slightly different, of the same object for a brief selected period of time (Animation). REC MODE should be set to "SP".

Select the desired recording time and press the Recording Start/Stop Button  after focusing on the subject.

- Fade- or wipe-in/out cannot be performed.
- This function is cancelled when the power is shut off or when the cassette is ejected.

INT. TIME

You can record sequentially at preset time spans. Leaving the camcorder aimed at a specific subject, you can record subtle changes over an extended period of time (Time-Lapse). REC MODE should be set to "SP".

Select the desired interval time and press the Recording Start/Stop Button .

- Fade- or wipe-in/out cannot be performed.
- This function is cancelled when the power is shut off or when the cassette is ejected.

TELE MACRO

When set to "ON", you can shoot a subject as large as possible at a distance of approx. 60 cm.

Depending on the zoom position, the lens may go out of focus.

MENU LANG.

Allows you to select the language (ENGLISH or RUSSIAN) of messages only in menu screens (CAMERA MENU, SYSTEM MENU or their sub-menus).

TITLE LANG.

Allows you to select the language (ENGLISH, FRENCH, RUSSIAN or UKRAINIAN) of TITLE in CAMERA MENU. After selection, the TITLE setting menu (⏏ p. 19) appears automatically.

DATE/TIME

Allows you to set the current date and time.
(⏏ pg. 7)

DEMO MODE

Demonstrates certain functions automatically. Available when the Power Switch **12** is set to “**A**” or “**M**” and “DEMO MODE” is set to “ON” (factory-preset). Performing any operation during the demonstration stops the demonstration temporarily. Set to OFF to stop completely.

- When a tape whose erase protection tab is in the position that allows recording is loaded in the camcorder, demonstration is not available.
- If you do not detach the Lens Cap, you cannot see the actual changes of the Automatic Demonstration activated on the LCD monitor* or viewfinder.

* Applicable models only.

ADVANCED FEATURES

Night-Scope (GR-SXM58/SXM48/SX24 only)

Makes dark subjects or areas even brighter than they would be under good natural lighting.

- 1) Set the Power Switch **12** to "A" or "M".
- 2) Press NIGHT-SCOPE **23** repeatedly until the desired mode appears.

NIGHT AUTO: The shutter speed is automatically adjusted (maximum 3/5 sec.).

1 NIGHT 20X (only when the Power Switch **12** is set to "M"): The shutter speed is set to 2/5th of a second to provide 20 times the sensitivity.

2 NIGHT 50X (only when the Power Switch **12** is set to "M"): The shutter speed is set to 1 second to provide 50 times the sensitivity.

- To cancel the effect, press NIGHT-SCOPE **23** repeatedly until "OFF" appears.
- During Night-Scope, the following cannot be activated: "Picture Stabiliser", "Programme AE With Special Effects", "Digital Effects" and "S.LX" in CAMERA MENU (pg. 19).
- Night-Scope does not work when LIGHT OFF/AUTO/ON **13** is set to "AUTO" or "ON" (pg. 13, "Video Light").
- During Night-Scope, it may be difficult to bring the camcorder into focus. To prevent this, use of a tripod is recommended.

Fade/Wipe Effects

Fade- or wipe-in works at recording start, and fade- or wipe-out works at recording end.

- 1) Set the Power Switch **12** to "M".
 - 2) Press FADE/WIPE **20** repeatedly until the desired mode appears.
 - 3) Press the Recording Start/Stop Button **11** to activate fade-in/out or wipe-in/out.
- Pressing and holding the Recording Start/Stop Button **11** allows you to vary the length for the image during fade in/out or wipe in/out.
 - To cancel a fade or wipe, press FADE/WIPE **20** repeatedly until "OFF" appears.

FADER: Fades in/out to a black screen.

MOSAIC (Fader): Gradually turns/returns the picture into/from a mosaic pattern.

SHUTTER (Wipe): A black screen moves in from the top and bottom, closing over the image like a shutter, or a new image pushes open the black screen vertically from the centre.





SLIDE (Wipe): A black screen moves in from the left to gradually cover the image, or a new image moves in from right to left.

DOOR (Wipe): Wipes in as the two halves of a black screen open to the left and right, revealing the scene, or wipes out and the black screen reappears from left and right to cover the scene.

CORNER (Wipe): Wipes in on a black screen from the upper right to the lower left corner, revealing the scene, or wipes out from lower left to upper right, leaving a black screen.

WINDOW (Wipe): Wipes in on a black screen from the centre of the screen towards the corners, revealing the scene, or wipe out from the corners to the centre, leaving a black screen.



Programme AE With Special Effects

- 1) Set the Power Switch  to "M".
 - 2) Press P.AE  repeatedly until the desired mode appears.
- To cancel the effect, press P.AE  repeatedly until "OFF" appears.
 - Only one mode can be engaged at a time.
 - In the "High Speed Shutter" or "Sports" modes, picture colour may be adversely affected if the subject is lit by alternating discharge-type light sources such as fluorescent or mercury-vapour lights.
 - This function cannot be activated during Night-Scope ( pg. 23).

 **SPORTS:** High shutter speed clearly captures fast-moving action.





ND : ND EFFECT: A black mist darkens the picture, as when an ND filter is used. Helps to counter the effects of glare on the subject.

FG : FOG: Makes the picture look misty white, as when an external fog filter is attached to the lens. Softens the image and gives it a "fantasy" look. This mode cannot be used when the "VIDEO ECHO" mode ( "Digital Effects") is activated.

 **TWILIGHT:** Dusk, twilight scenery, fireworks, etc., look more natural and dramatic. In this mode, S.LX and AUTO FOCUS in CAMERA MENU ( pg. 18, 19) may not work.

 **S1/2000 (1/2000 sec. High Speed Shutter):** Captures faster action than Sports mode. The screen becomes slightly dark. Use in well-lit situations.

Digital Effects

- 1) Set the Power Switch  to "M".
 - 2) Press DIGIFECT  repeatedly until the desired mode appears.
- To cancel the effect, press DIGIFECT  repeatedly until "OFF" appears.
 - This function cannot be activated during Night-Scope ( pg. 23).
 - Picture Stabiliser cannot be activated during the "CLASSIC FILM", "STROBE" and "VIDEO ECHO" mode.

 **SEPIA:** Recorded scenes have a brownish tint like old photos. Combine this with WIDE in SYSTEM MENU for a classic look.

B/W MONOTONE: Like black and white films, your footage is shot in B/W. Combine this with WIDE in SYSTEM MENU for a classic look.

 **B. FILTER:** Recorded scenes have a bluish tint.

 **R. FILTER:** Recorded scenes have a reddish tint.

 **SOLARI:** The picture is recorded with an effect similar to a painting.

 **NEGA POSI:** The colours of a picture are reversed.

 **MOSAIC:** Turns recorded scenes into a mosaic pattern.

 **STRETCH:** Doubles the width of the picture horizontally.

 **CLASSIC FILM*:** Makes your footage look like a classic movie by shooting in black and white, with a strobing effect, and black bars added at the top and bottom.

 **STROBE*:** Your recording looks like a series of consecutive snapshots.

 **VIDEO ECHO*:** Adds a "ghost" to the subject, giving your recording a "fantasy" feeling. Zoom magnification of over 10X is not available.

*GR-SXM58/SXM48/SX24 only.

TROUBLESHOOTING

Before consulting your JVC dealer, please check the following to see if you can correct the problem yourself.

Vertical white lines appear when shooting a very bright object.

- This sometimes occurs when the contrast between the back-ground and the object is great. It is not a defect of the camcorder.

Bright, crystal-shaped spots appear in the LCD monitor and the viewfinder.

- Sunlight is directly entering the lens. This is not a defect of the camcorder.

Coloured bright spots appear all over the LCD monitor or the viewfinder.

- The LCD monitor and the viewfinder are made with high-precision technology. However, black spots or bright spots of light (red, green or blue) may appear constantly on the LCD monitor or in the viewfinder. These spots are not recorded on the tape. This is not due to any defect of the unit. (Effective dots: more than 99.99 %.)

Animation or Time-Lapse is not available.

- Before recording in the Animation mode at the very beginning of a tape, set the camcorder to the Recording mode for about 5 seconds, so that the tape runs smoothly. Using the Fade-in function at this point is a good way to begin an animated programme (☞ pg. 21, REC TIME/INT. TIME in SYSTEM MENU).

The tape is running, but there is no playback picture.

- The TV has not been set to its VIDEO mode or channel.
- If A/V connection is used, the TV's VIDEO/TV Switch has not been set to VIDEO.

Playback picture is blurred or interrupted.

- The video heads are dirty or worn out. Consult your nearest JVC dealer for head cleaning or replacement.

The tape stops during fast-forward or rewind.

- The Counter Memory Function has been activated (☞ pg. 14, "Counter Memory").

The date and time displays disappear.



- If you remove the power source from the camcorder while the power is on, all settings and selections are erased. Make sure to turn the camcorder's power off before disconnecting the power source.

The tape will not eject.

- The battery pack is running low.
- If the LCD monitor is not open over 60 degrees, the EJECT switch  does not function.

The camcorder is a microcomputer-controlled device. External noise and interference (from a TV, a radio, etc.) might prevent it from functioning properly. In such cases, first disconnect its power supply unit (battery pack, AC Adapter, etc.); and then re-connect it and proceed as usual from the beginning.

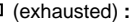
Warning Indications

 (high) →  (exhausted) : Displays the battery remaining power level. As the battery power comes close to nil, the battery indicator  blinks (battery power warning). When the battery power is exhausted, power turns off automatically.

 : Blinks when no cassette is loaded, or when the erase protection tab is not in the position that allows recording.

TAPE END: Appears when the tape ends during recording, playback or fast-forward.

LENS CAP: Appears for 5 seconds after power is turned on if the lens cap is attached.

 **CONDENSATION OPERATION PAUSED PLEASE WAIT:** These 2 warnings appear alternately every 3 seconds if condensation occurs. In this case, all functions except tape eject and power on/off are disabled. Remove the tape, turn the unit off (without removing the power supply), wait a few minutes for the warnings to clear, and turn it on again.

 **HEAD CLEANING REQUIRED USE CLEANING CASSETTE:** These 2 warnings appear alternately every 3 seconds if dirt is detected on the heads during recording. In this case, use an optional cleaning cassette. If the warning remains after cleaning, consult your nearest JVC dealer.

E01—E06 UNIT IN SAFEGUARD MODE REMOVE AND REATTACH BATTERY: The error indications (E01 — E06) show what type of malfunction has occurred. If an error indication and warning appear, turn the unit off, remove the power supply (battery, etc.) and wait a few minutes for them to clear. When it does, you can resume using the camcorder. If the indication remains, consult your nearest JVC dealer.

CAUTIONS

Video Light (for applicable models)

DANGER:

- The video light becomes extremely hot. Do not touch it either while in operation or soon after turning it off, otherwise serious injury may result.
- Do not place the camcorder into the carrying case immediately after using the video light, since it remains extremely hot for some time.
- When operating, keep a distance of about 30 cm between the video light and people or object.
- Do not use near flammable or explosive materials.
- It is recommended that you consult your nearest JVC dealer for replacing the video light.



General Battery Precautions

If the cassette adapter is not functioning even if it is being operated correctly, the batteries are exhausted. Replace them with fresh ones.

Use only the specified batteries pg. 2 "PROVIDED ACCESSORIES"

Please make note of the following rules for battery use. When misused, the batteries can leak or explode.

1. When replacing batteries, read the cassette adapter (C-P6U/C-P7U) instructions.
2. **Do not** use any different size of batteries from those specified.
3. Be sure to install batteries in the correct direction.
4. **Do not** use rechargeable batteries.
5. **Do not** expose the batteries to excessive heat as they can leak or explode.
6. **Do not** dispose of the batteries in a fire.
7. Remove the batteries from the unit if it is to be stored for an extended period to avoid battery leakage which can cause malfunctions.

Battery Packs

The battery packs are nickel-cadmium or nickel metal-hydrate batteries. Before using the supplied battery pack or an optional battery pack, be sure to read the following cautions:

1. To avoid hazard . . .

- **do not** burn.
- **do not** short-circuit the terminals.
- **do not** modify or disassemble.
- use only specified chargers.

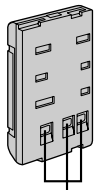

Terminals

2. To prevent damage and prolong service life . . .

- **do not** subject to unnecessary shock.
- avoid repeated charging without fully discharging.
- charge in an environment where temperatures are within the tolerances shown in the chart below. This is a chemical reaction type battery—cooler temperatures impede chemical reaction, while warmer temperatures can prevent complete charging.
- store in a cool, dry place. Extended exposure to high temperatures will increase natural discharge and shorten service life.
- avoid prolonged uncharged storage.
- remove from charger or powered unit when not in use, as some machines use current even when switched off.
- It is normal for the battery pack to be warm after charging, or after use.
Temperature Range Specifications
Charging 10°C to 35°C
Operation 0°C to 40°C
Storage -10°C to 30°C
- Recharging time is based on room temperature of 20°C.
- The lower the temperature, the longer recharging takes.

Cassettes

To properly use and store your cassettes, be sure to read the following cautions:

1. During use . . .

- make sure the cassette bears the S-VHS-C or VHS-C mark.
- be aware that recording onto prerecorded tapes automatically erases the previously recorded video and audio signals.
- make sure the cassette is positioned properly when inserting.
- do not load and unload the cassette repeatedly without allowing the tape to run at all. This slackens the tape and can result in damage.
- do not open the front tape cover. This exposes the tape to fingerprints and dust.

2. Store cassettes . . .

- away from heaters or other heat sources.
- out of direct sunlight.
- where they won't be subject to unnecessary shock or vibration.
- where they won't be exposed to strong magnetic fields (such as those generated by motors, transformers or magnets).
- vertically, in their original cases.

Main Unit

1. For safety, DO NOT . . .

- open the camcorder's chassis.
- disassemble or modify the unit.
- short-circuit the terminals of the battery pack. Keep it away from metallic objects when not in use.
- allow inflammables, water or metallic objects to enter the unit.
- remove the battery pack or disconnect the power supply while the power is on.
- leave the battery pack attached when the camcorder is not in use.

2. Avoid using the unit . . .

- in places subject to excessive humidity or dust.
- in places subject to soot or steam such as near a cooking stove.
- in places subject to excessive shock or vibration.
- near a television set.
- near appliances generating strong magnetic or electric fields (speakers, broadcasting antennas, etc.).
- in places subject to extremely high (over 40°C) extremely low (under 0°C) temperatures.

3. DO NOT leave the unit . . .

- in places of over 50°C.
- in places where humidity is extremely low (below 35%) or extremely high (above 80%).
- in direct sunlight.
- in a closed car in summer.
- near a heater.
- in dusty places such as a beach.

4. To protect the unit, DO NOT . . .

- allow it to become wet.
- drop the unit or strike it against hard objects.
- subject it to shock or excessive vibration during transportation.
- keep the lens directed at extremely bright objects for long periods.
- direct the eyepiece of the viewfinder at the sun.
- carry it by holding the viewfinder or the LCD monitor*. Be sure to hold the main unit with both hands or use the grip.
* Applicable models only.
- swing it excessively when using the shoulder strap.

LCD Monitor (for applicable models)

1. To prevent damage to the LCD monitor, DO NOT . . .

- push it strongly or apply any shocks.
- place the camcorder with the LCD monitor on the bottom.

2. To prolong service life . . .

- avoid rubbing it with coarse cloth.

3. Be aware of the following phenomena for LCD monitor use. These are not malfunctions:

- While using the camcorder, the surface around the LCD monitor and/or the back of the LCD monitor may heat up.
- If you leave power on for a long time, the surface around the LCD monitor becomes hot.

How To Handle a CD-ROM (for applicable models)

- Take care not to soil or scratch the mirror surface (opposite to the printed surface). Do not write anything or put a sticker on either the front or back surface. If the CD-ROM gets dirty, gently wipe it with a soft cloth outward from the centre hole using a circular motion.
- Do not use conventional disc cleaners or cleaning spray.
- Do not bend the CD-ROM or touch its mirror surface.
- Do not store your CD-ROM in a dusty, hot or humid environment. Keep it away from direct sunlight.

About moisture condensation . . .

- You may have observed that pouring a cold liquid into a glass will cause drops of water to form on the glass' outer surface. This same phenomenon occurs on the head drum of a camcorder when it is moved from a cool place to a warm place, after heating a cold room, under extremely humid conditions or in a place directly subjected to the cool air from an air conditioner.
- Moisture on the head drum can cause severe damage to the video tape, and can lead to internal damage to the camcorder itself.

Serious malfunctioning

If malfunctioning occurs, stop using the unit immediately and consult your local JVC dealer.

For Your Maintenance

1. After Use

- ① Set the **Power Switch** to "OFF" to turn off the camcorder.
- ② Open the LCD monitor* to an angle of over 60 degrees. Slide **EJECT** to open the cassette holder, then remove the cassette.
- ③ Close and lock the cassette holder by pressing the **Close** button.
- ④ Close and lock the LCD monitor*.
- ⑤ Slide **BATTERY RELEASE** to remove the battery pack.
- ⑥ Attach the provided lens cap to the camcorder's lens.

2. Cleaning The Camcorder

- ① Wipe gently the exterior with a soft cloth. Put cloth in diluted mild soap and wring it well to wipe off heavy dirt, then wipe again with a dry cloth.
- ② Open the LCD monitor* and wipe it gently with a soft cloth. Be careful not to damage the monitor. Close the LCD monitor*.
- ③ Blow the lens with a blower brush, then wipe it gently with lens cleaning paper.
- ④ Turn the eyepiece counterclockwise and pull it out.
- ⑤ Remove dust from the viewfinder using a blower brush.
- ⑥ Re-attach the eyepiece and turn it clockwise.

* Applicable models only.

- Avoid using strong cleaning agents such as benzine or alcohol.
- Cleaning should be done only after the battery pack has been removed or other power units have been disconnected.
- Mould may form if the lens is left dirty.
- When using a cleaner or chemically treated cloth, refer to the cautions that came with it.
- When removing the eyepiece, be sure to hold the viewfinder securely.

SPECIFICATIONS

Camcorder

General

Format	: S-VHS (GR-SXM58/SXM48/SX24 only)/VHS PAL standard
Power source	: DC 11 V --- (Using AC Adapter) DC 6 V --- (Using battery pack)
Power consumption	
Viewfinder on	: 4.0 W (GR-SXM58/SXM48/ FXM383/FXM38 only) 3.7 W (GR-SX24/FX14 only)
LCD monitor* on	: 4.5 W (GR-SXM58/SXM48/ FXM383/FXM38 only)
Video light**	: 3.0 W

* Applicable models only.

** GR-SXM58/SXM48/FXM383/SX24 only.

Signal system : PAL-type

Video recording system

Luminance	: FM recording
Colour	: Converted sub-carrier direct recording Conforms to VHS standard

Cassette :  /  cassette

Tape speed

SP	: 23.39 mm/sec.
LP	: 11.70 mm/sec.

Recording time (max.)

SP	: 60 minutes
LP	: 120 minutes (with EC-60 cassette)

Operating

temperature : 0°C to 40°C

Operating humidity : 35% to 80%

Storage temperature : -20°C to 50°C

Weight : Approx. 910 g (GR-SXM58/
SXM48/FXM383 only)
Approx. 900 g (GR-FXM38 only)
Approx. 860 g (GR-SX24 only)
Approx. 850 g (GR-FX14 only)

Dimensions : 200 mm x 112 mm x 118 mm
(W x H x D) (GR-SXM58/SXM48/FXM383/
FXM38 only)
200 mm x 112 mm x 115 mm
(GR-SX24/FX14 only)
(with the LCD monitor* closed and
with the viewfinder fully tilted
downward)

* Applicable models only.

Pickup	: 1/6" format CCD
Lens	: F1.6, f = 3.9 mm to 62.4 mm, 16:1 power zoom lens with auto iris and macro control, filter diameter 40.5 mm
Viewfinder	: Electronic viewfinder with 0.5" black/white CRT
White balance adjustment	: Auto/Manual adjustment
LCD monitor (Applicable models only)	: 2.5" diagonally measured, LCD panel/TFT active matrix system
Speaker (Applicable models only)	: Monaural



Connectors

Video	: 1 V (p-p), 75 Ω unbalanced, analogue output (via Video output connector)
Audio	: 300 mV (rms), 1 k Ω analogue output (via Audio output connector)
Digital (GR-SXM58 only)	: \varnothing 3.5 mm, 4-pole, mini-head jack
S-Video (GR-SXM58/ SXM48/SX24 only)	: Y : 1 V (p-p), 75 Ω , analogue output C : 0.30 V (p-p), 75 Ω , analogue output

AC Adapter

Power requirement	: AC 110 V — 240 V \sim , 50 Hz/60 Hz
Output	: DC 11 V --- , 1 A

Optional Accessories

- Battery Packs BN-V12U, BN-V20U, BN-V400U
- Compact S-VHS () Cassettes SE-C45/30
- Compact VHS () Cassettes EC-60/45/30
- Active Carrying Bag CB-V7U
- Cassette Adapter C-P7U

Some accessories are not available in some areas.
Please consult your nearest JVC dealer for details on
accessories and their availability.

Specifications shown are for SP mode unless otherwise indicated. E & O.E. Design and specifications subject to change without notice.