

JVC



COMPACT VHS CAMCORDER

GR-FXM65

Compact VHS

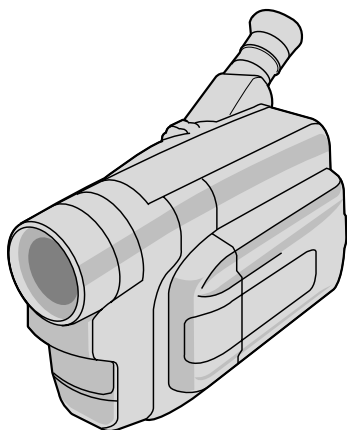

INSTRUCTIONS



CONTENTS

GETTING STARTED	8-15
Power	8
Clock (Lithium) Battery Insertion/Removal ...	10
Date/Time Settings	11
Recording Mode Setting	12
Tape Length Setting	12
Loading/Unloading A Cassette	13
Grip Adjustment	14
Viewfinder Adjustment	14
Shoulder Strap Attachment	15
Tripod Mounting	15
VIDEO RECORDING	16-19
Basic Recording	16
DIGITAL STILL CAMERA (D.S.C.) SHOOTING	20-23
Basic Shooting	20
RECORDING	24-43
Basic Features	24
Advanced Features	29
VIDEO PLAYBACK	44-47
Basic Playback	44
Features	45
Using The Cassette Adapter	47
PLAYBACK	48-49
Basic Connections And Tape Dubbing	48
D.S.C. PLAYBACK	50-57
Basic Playback	50
Connection	51
Advanced Features	52
USING THE REMOTE CONTROL UNIT	58
Random Assemble Editing	60
Insert Editing (VIDEO)	64
Insert Editing (Insert A Still Image From The Built-in Memory Onto A Tape)	65
Audio Dubbing	66
TROUBLESHOOTING	67-69
INDEX	70-73
Controls, Connectors And Indicators	70
Indications	72
Terms	74
USER MAINTENANCE	76
CAUTIONS	77-79
SPECIFICATIONS	80

Dear Customer,

Thank you for purchasing the JVC Compact VHS camcorder. Before use, please read the safety information and precautions contained in the following pages to ensure safe use of this product.

Using This Instruction Manual

- All major sections and subsections are listed in the Table Of Contents (☞ cover page).
- Notes appear after most subsections. Be sure to read these as well.
- Basic and advanced features/operation are separated for easier reference.

It is recommended that you . . .

- refer to the Index (☞ pgs. 70 – 75) and familiarize yourself with button locations, etc. before use.
- read thoroughly the Safety Precautions. They contain extremely important information regarding the safe use of this product.

You are recommended to carefully read the cautions on pages 77 and 79 before use.

SAFETY PRECAUTIONS

IMPORTANT**Connection to the mains supply in the United Kingdom.****DO NOT cut off the mains plug from this equipment.**

If the plug fitted is not suitable for the power points in your home or the cable is too short to reach a power point, then obtain an appropriate safety approved extension lead or consult your dealer.

BE SURE to replace the fuse only with an identical approved type, as originally fitted, and to replace the fuse cover.

If nonetheless the mains plug is cut off be sure to remove the fuse and dispose of the plug immediately, to avoid a possible shock hazard by inadvertent connection to the mains supply.

If this product is not supplied fitted with a mains plug then follow the instructions given below:

DO NOT make any connection to the Larger Terminal coded E or Green.

The wires in the mains lead are coloured in accordance with the following code:

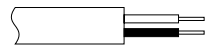

Blue to N (Neutral) or Black
Brown to L (Live) or Red

If these colours do not correspond with the terminal identifications of your plug, connect as follows:

Blue wire to terminal coded N (Neutral) or coloured black.

Brown wire to terminal coded L (Live) or coloured Red.

If in doubt — consult a competent electrician.

**WARNING:
TO PREVENT FIRE OR SHOCK
HAZARD, DO NOT EXPOSE
THIS UNIT TO RAIN OR
MOISTURE.****Warning on lithium cell battery (for clock operation and remote control unit)**

The battery used in this device may present a fire or chemical burn hazard if mistreated. Do not recharge, disassemble, heat above 100°C or incinerate.

Replace the battery with Maxell, Panasonic (Matsushita Electric), Sanyo or Sony CR2025; use of another battery may present a risk of fire or explosion.

- Dispose of used battery promptly.
- Keep away from children.
- Do not disassemble and do not dispose of in fire.

CAUTIONS:

- To prevent shock, do not open the cabinet. No user serviceable parts inside. Refer servicing to qualified personnel.
- When you are not using the AC Power Adapter/Charger for a long period of time, it is recommended that you disconnect the power cord from AC outlet.

NOTES:

- The rating plate (serial number plate) and safety caution are on the bottom and/or the back of the main unit.
- The rating plate (serial number plate) of the AC Power Adapter/Charger is on its bottom.

This camcorder is designed to be used with PAL-type colour television signals. It cannot be used for playback with a television of a different standard. However, live recording and LCD monitor/ viewfinder playback are possible anywhere. Use the BN-V12U/V20U battery packs and, to recharge them, the provided multi-voltage AC Power Adapter/Charger. (An appropriate conversion adapter may be necessary to accommodate different designs of AC outlets in different countries.)

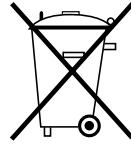
Crossed Out Dust Bin Mark

Cd

- The Crossed Out Dust Bin Mark on the battery pack indicates that the product complies with Directives 91/157/EEC and 93/86/EEC.
- Nickel-Cadmium (Ni-Cd) battery pack must be recycled or disposed of properly.

This unit is produced to comply with Standard IEC Publ. 65.

SOME DO'S AND DON'TS ON THE SAFE USE OF EQUIPMENT

This equipment has been designed and manufactured to meet international safety standards but, like any electrical equipment, care must be taken if you are to obtain the best results and safety is to be assured.

- DO** read the operating instructions before you attempt to use the equipment.
 - DO** ensure that all electrical connections (including the mains plug, extension leads and interconnections between pieces of equipment) are properly made and in accordance with the manufacturer's instructions. Switch off and withdraw the mains plug when making or changing connections.
 - DO** consult your dealer if you are ever in doubt about the installation, operation or safety of your equipment.
 - DO** be careful with glass panels or doors on equipment.
 - DON'T** continue to operate the equipment if you are in any doubt about it working normally, or if it is damaged in any way — switch off, withdraw the mains plug and consult your dealer.
 - DON'T** remove any fixed cover as this may expose dangerous voltages.
 - DON'T** leave equipment switched on when it is unattended unless it is specifically stated that it is designed for unattended operation or has a standby mode. Switch off using the switch on the equipment and make sure that your family knows how to do this. Special arrangements may need to be made for infirm or handicapped people.
 - DON'T** use equipment such as personal stereos or radios so that you are distracted from the requirements of road safety. It is illegal to watch television whilst driving.
 - DON'T** listen to headphones at high volume, as such use can permanently damage your hearing.
 - DON'T** obstruct the ventilation of the equipment, for example with curtains or soft furnishings. Overheating will cause damage and shorten the life of the equipment.
 - DON'T** use makeshift stands and NEVER fix legs with wood screws — to ensure complete safety always fit the manufacturer's approved stand or legs with the fixings provided according to the instructions.
 - DON'T** allow electrical equipment to be exposed to rain or moisture.
- ABOVE ALL**

- NEVER let anyone especially children push anything into holes, slots or any other opening in the case — this could result in a fatal electrical shock;
- NEVER guess or take chances with electrical equipment of any kind — it is better to be safe than sorry!

REMEMBER

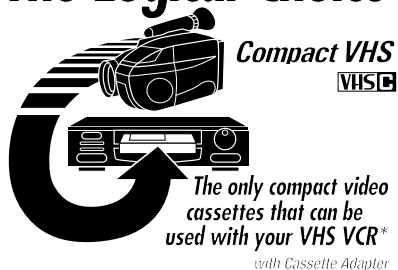
The Logical Choice

Digital Still Camera Built-in
(PC communication capable)
(☞ pg. 20 - 23, 50 - 57)

Menu Adjustment
(☞ pg. 34, 35, 36)

Integrated Auto Light
(☞ pg. 28)

Programme AE with Special Effects (☞ pg. 30, 31)

- Electronic Fog Filter
- ND Effect
- Sepia
- Twilight
- Sports
- Nega/Posi
- 1/2000 sec. High Speed Shutter

Picture Stabilizer (☞ pg. 27)

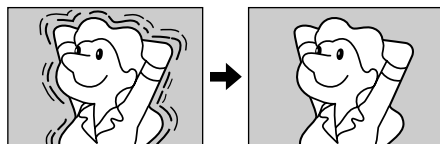

LCD Colour Monitor
(☞ pg. 18)

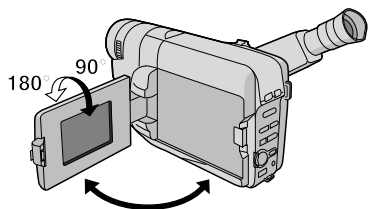

Digital Hyper Zoom
(☞ pg. 26)

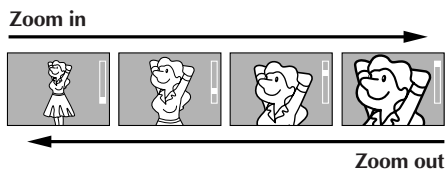

- This camcorder is designed exclusively for the VHS-C video cassette. Only cassettes marked VHS-C can be used with this unit.
- HQ VHS is compatible with existing VHS equipment.

PROVIDED ACCESSORIES



• AC Power Adapter/
Charger AA-V15EK

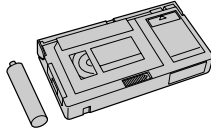

• Cassette Adapter C-P7U

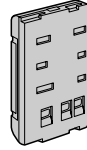

• Battery Pack BN-V12U

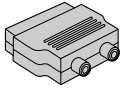

• Cable Adapter

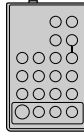

• Remote Control
Unit RM-V709U

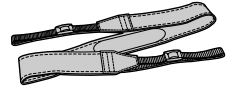

• Shoulder Strap



• Lithium Battery CR2025 x 2
(for clock operation and
remote control unit)



• Editing cable

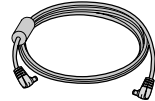

• DC Cord



(for Windows® PC)

• PC Connection
Cable x 1

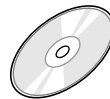

• CD-ROM including
two software
programmes

The image you shoot is recorded onto a video tape.

SUPPLY POWER

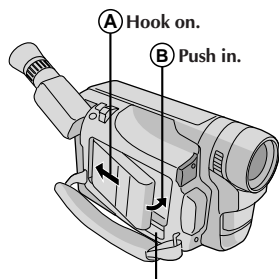

BATTERY RELEASE

Using the battery pack

Hook its end to the camcorder (A) and push the battery pack in until it locks in place (B).
(Charging procedure, pg. 8)

To remove the battery pack

Slide **BATTERY RELEASE** and pull out the battery pack.

INSERTING A VIDEO CASSETTE

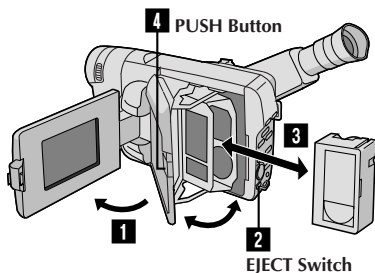

- 1 Open the LCD monitor to an angle of over 60 degrees.
- 2 Slide **EJECT** to open the cassette holder.
- 3 Insert a video cassette.
- 4 Press **PUSH** to close the cassette holder.
(For more details, pg. 13)

PLAYBACK

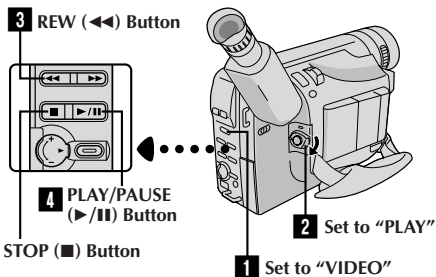

- 1 Set the System Select Switch to "VIDEO".
 - 2 Set the Power Switch to "PLAY".
 - 3 Press **REW** (◀◀).
 - 4 Press **PLAY/PAUSE** (▶/||).
- The tape will automatically stop at the beginning of the tape.
 - Playback starts and the playback picture appears.
 - To stop playback, press **STOP** (■).
- (For more details, pg. 44.)
- The viewfinder switches off automatically to save power when the LCD monitor is opened at an angle of over 60 degrees.
 - The LCD monitor turns on/off when it is opened/closed at approx. 60 degrees.

Or simply play back the tape on a VHS VCR using the Cassette Adapter. pg. 47

SHOOTING

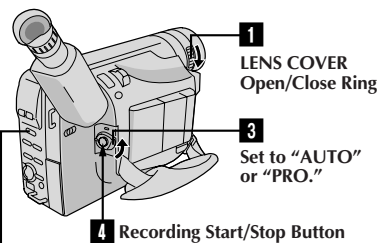

- 1 Turn the **LENS COVER** Open/Close Ring to open the lens cover.
 - 2 Set the System Select Switch to "VIDEO".
 - 3 Set the Power Switch to "AUTO" or "PRO.".
 - The power lamp will light and an image will appear.
 - 4 Press the Recording Start/Stop Button.
 - Recording starts.
- (For more details, pgs. 16 – 19)
- The viewfinder switches off automatically to save power when the LCD monitor is opened at an angle of over 60 degrees.
 - The LCD monitor turns on/off when it is opened/closed at approx. 60 degrees.

A still image you shoot is stored in the camcorder's built-in memory.

SUPPLY POWER

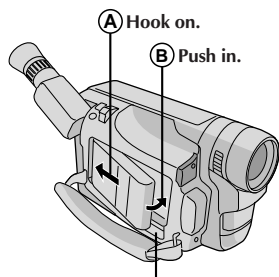

BATTERY RELEASE

Using the battery pack

Hook its end to the camcorder (A) and push the battery pack in until it locks in place (B).
(Charging procedure, pg. 8)

To remove the battery pack

Slide **BATTERY RELEASE** and pull out the battery pack.

SHOOTING

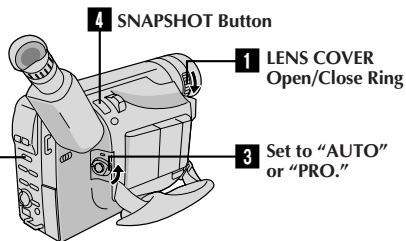

2 System Select Switch
Set to "D.S.C."

- 1** Turn the **LENS COVER** Open/Close Ring to open the lens cover.
- 2** Set the System Select Switch to "D.S.C."
- 3** Set the Power Switch to "AUTO" or "PRO."
— The power lamp will light and an image will appear.
- 4** Press the **SNAPSHOT** Button.
— A still image is shot and is stored in the camcorder's memory.
(For more details, pgs. 20 – 23)

- The viewfinder switches off automatically to save power when the LCD monitor is opened at an angle of over 60 degrees.
- The LCD monitor turns on/off when it is opened/closed at approx. 60 degrees.

PLAYBACK

REW (◀◀/PAGE -) Button,
FF (▶▶/PAGE +) Button

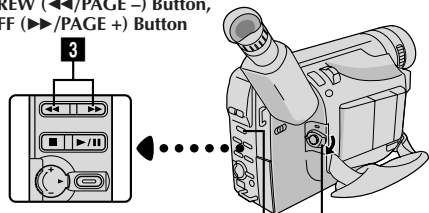

1 System Select Switch
Set to "D.S.C."

2 Set to "PLAY"

- 1** Set the System Select Switch to "D.S.C."
- 2** Set the Power Switch to "PLAY".
— A still image stored in memory appears.
- 3** Press **REW** (◀◀/PAGE -) or **FF** (▶▶/PAGE +) to select the still image you want to view.

(For more details, pg. 50.)

- The viewfinder switches off automatically to save power when the LCD monitor is opened at an angle of over 60 degrees.
- The LCD monitor turns on/off when it is opened/closed at approx. 60 degrees.

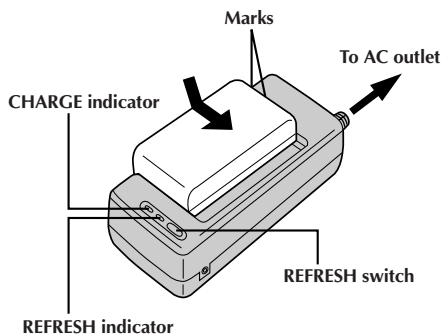

REFRESH

The AC Power Adapter/Charger features a REFRESH function that allows you to fully discharge the battery pack before recharging. Perform the REFRESH function after no less than 5 chargings.

To discharge the battery . . .

.... attach the battery pack to the adapter as shown in the above illustration. Then push REFRESH. The REFRESH indicator lights when discharging starts, and goes out when discharging is complete.

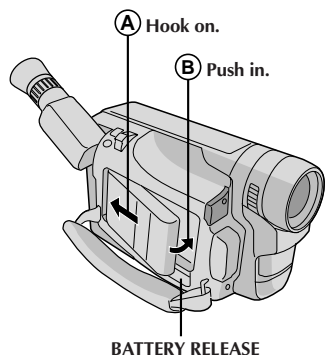

ATTENTION:

Before detaching the power source, make sure that the camcorder's power is turned off. Failure to do so can result in a camcorder malfunction.

Power

This camcorder's 3-way power supply system lets you choose the most appropriate source of power.

NOTES:

- No function is available without power supply.
- Use only the specified power supply.
- Do not use provided power supply units with other equipment.

CHARGING THE BATTERY PACK

1 SUPPLY POWER

Connect the charger's AC power cord to a wall outlet.

2 ATTACH BATTERY PACK

Align the marks and slide the battery pack in the direction of the arrow until it locks in place.

- The CHARGE indicator begins blinking to indicate charging has started.

3 DETACH BATTERY PACK

When the CHARGE indicator stops blinking but stays lit, charging is finished. Slide the battery pack opposite the direction of the arrow.

Battery pack	Charging time	Discharging time
BN-V12U	approx. 1 hr. 10 min.	approx. 3 hrs. 30 min.
BN-V20U	approx. 1 hr. 50 min	approx. 6 hrs. 40 min.

USING THE BATTERY PACK

1 ATTACH BATTERY PACK

Hook its end to the camcorder (A) and push the battery pack in until it locks in place (B).

2 DETACH BATTERY PACK

Slide BATTERY RELEASE and pull out the battery pack.

Approximate recording time (unit: min.)

Battery pack	LCD monitor on/ Viewfinder off	LCD monitor off/ Viewfinder on	LCD monitor on/ Viewfinder on
BN-V12U	50 (35)	55 (35)	45 (30)
BN-V20U	85 (55)	90 (55)	75 (50)

() : when the video light is on.

INFORMATION:

VU-V856KIT is a set composed of the BN-V856U battery pack and AA-V80EK AC Power Adapter/Charger.

The BN-V856U battery pack provides approx. 7 hours of recording time when the viewfinder is on and the LCD monitor and the video light are off. Also read thoroughly the VU-V856KIT's instruction manuals.

It is impossible to charge the BN-V856U battery pack using the provided AC Power Adapter/Charger. Use the optional AA-V80EK AC Power Adapter/Charger.

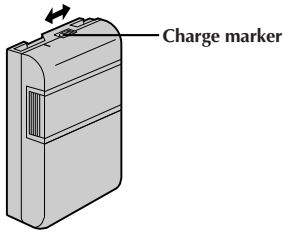

Charge Marker

A charge marker is provided on the battery pack to help you remember whether it has been charged or not. Two colours are provided (red and black)—you choose which one means charged and which means discharged.

NOTES:

- The recording time per charge is affected by such factors as the time spent in Record-Standby mode and the frequency of zooming. It is safer to have spare battery packs to cover 3 times the planned shooting time.
- Charging times noted on page 8 are for a fully discharged battery pack, and discharging times are for a fully charged battery pack.
- Charging and discharging times vary according to the ambient temperature and the status of the battery pack.
- Remember to set the charge marker after charging a battery pack or after detaching a discharged one from your camcorder.
- Perform the REFRESH function after no less than 5 chargings.
- While the AC Power Adapter/Charger's power cord is disconnected from the AC outlet, it is possible to discharge the battery by pressing the REFRESH switch. During that time, the AC Power Adapter/Charger does not charge the battery. When discharging is complete, detach the battery from the AC Power Adapter/Charger to store it.
- High temperatures can damage the battery pack, so use only where good ventilation is available. Do not allow it to discharge in a container, such as a bag.
- If you stop recharging or discharging part way through, make sure to remove the battery pack before unplugging the adapter's AC cord.
- Remove the battery pack from the adapter immediately after discharging.
- To avoid interference with reception, do not use the AC Power Adapter/Charger near a radio.
- Make sure you unplug the DC cord before charging or discharging the battery pack.
- The CHARGE indicator may not light properly with a brand new battery pack, or with one that has been stored for an extended period. In this case, remove and reattach the battery pack and recharge it. The CHARGE indicator should blink during recharging. If it doesn't, contact your nearest JVC dealer.

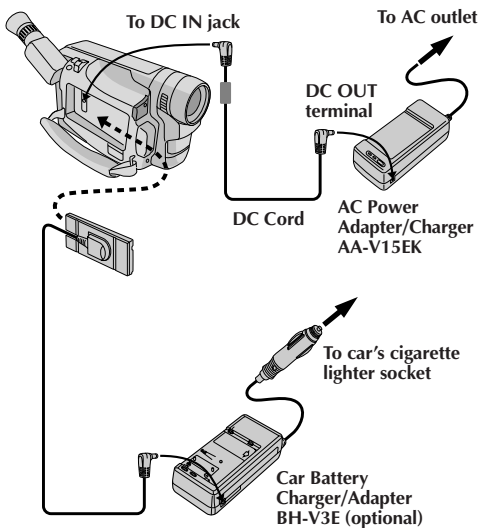

USING AC POWER

Use the AC Power Adapter/Charger (connect as shown in the illustration).

NOTES:

- The provided AC Power Adapter/Charger features automatic voltage selection in the AC range from 110 V to 240 V.
- When using the DC cord, make sure you connect the end of the cord with the core filter to the camcorder. The core filter reduces interference.

USING A CAR BATTERY

Use the optional Car Battery Charger/Adapter (connect as shown in the illustration).

NOTES:

- When using the car battery, leave the engine idling.
- The optional Car Battery Charger/Adapter (BH-V3E) can also be used to charge the battery pack (except BN-V20U/V856U).
- When using the optional Car Battery Charger/Adapter or Car Battery Cord (AP-V7U), refer to the respective instruction booklet.

Clock (Lithium) Battery Insertion/Removal

This battery is necessary for clock operation and to perform date/time settings.

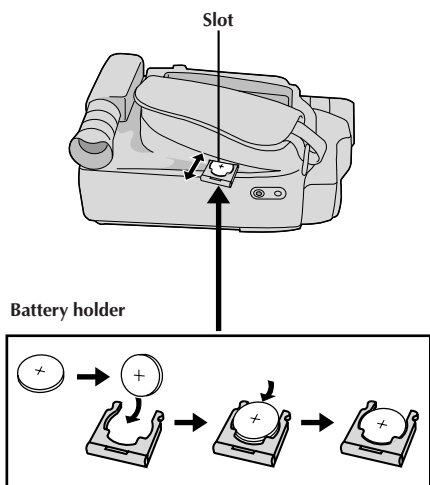

1 SWITCH OFF POWER

Switch off the unit's power and remove the power supply unit (battery pack, AC Power Adapter/Battery Charger, etc.).

2 REMOVE BATTERY HOLDER

Pull out the battery holder.

3 INSERT BATTERY IN HOLDER

Insert the battery in the holder, and be sure to have the "+" mark visible.

4 RE-INSERT HOLDER

Slide the holder back into the slot until you hear a click.

NOTES:

- See "SAFETY PRECAUTIONS" (☞ pg. 2) for information on safe handling of lithium batteries.
- To avoid losing the battery and/or battery holder, place the camcorder with the grip side up as shown in the illustration when inserting/removing the battery.

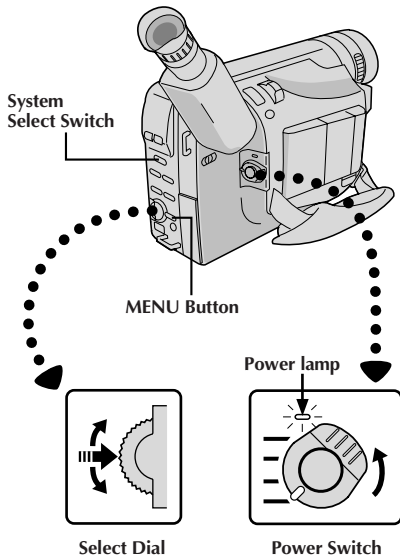

Display

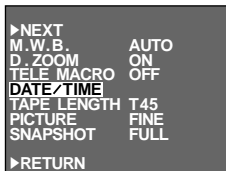

Menu Screen

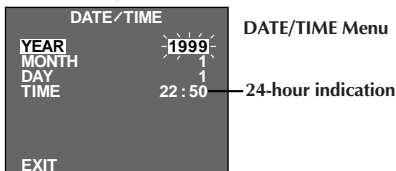

DATE/TIME Menu

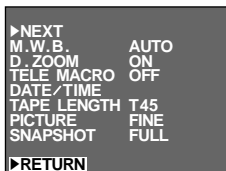

Date/Time Settings

1 SELECT OPERATION SYSTEM AND MODE

Set the System Select Switch to "VIDEO" or "D.S.C.", and set the Power Switch to "PRO."

- The power lamp comes on.

2 ACCESS MENU SCREEN

Press MENU.

3 SELECT FUNCTION

Rotate the Select Dial to move the highlight bar to "DATE/TIME", then press it. The DATE/TIME Menu appears.

- If you decide you want to return the date and time to the previous settings, rotate the Select Dial to move the highlight bar to "EXIT" and press it, then go to step 7.
- If you want to set only the time without changing the date, go to step 5.

4 SET DATE

Rotate the Select Dial to move the highlight bar to the item you want to set and then press it. When the setting begins blinking, rotate the Select Dial until the correct setting appears and then press it. The setting stops blinking.

- Repeat this procedure until you're satisfied with the Date settings ("YEAR", "MONTH" and "DAY").

5 SET TIME

Rotate the Select Dial to move the highlight bar to "TIME" and then press it. When the hour setting begins blinking, rotate the Select Dial until the correct setting appears and then press it. When the hour setting stops blinking and the minute setting begins blinking, rotate the Select Dial until the correct setting appears and then press it. The minute setting stops blinking.

6 START CLOCK OPERATION

When none of these settings ("YEAR", "MONTH", "DAY", "TIME") blinks, rotate the Select Dial to move the highlight bar to "EXIT", and press it. The Menu Screen reappears with the highlight bar on "RETURN".

7 CLOSE MENU SCREEN

Press the Select Dial.

NOTE:

To display the date and time in the camcorder's display and on a connected TV, see "Date/Time Insert" (pg. 32).

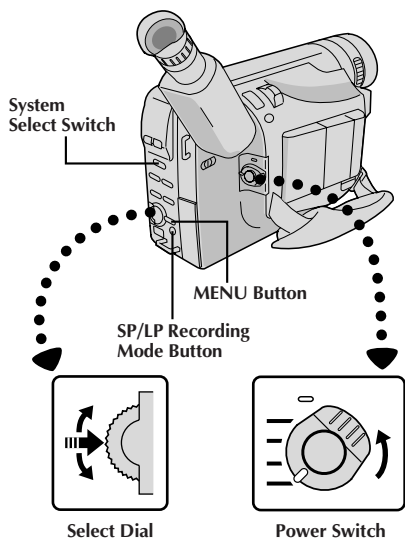

Viewfinder

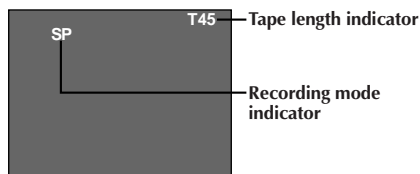

Display

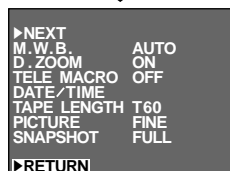
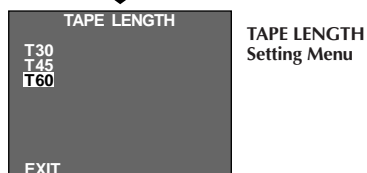
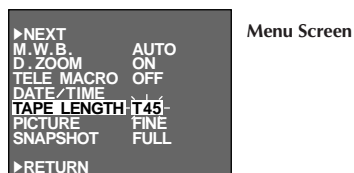

Recording Mode Setting

Set depending on your preference.

1 SET RECORDING MODE

First set the System Select Switch to "VIDEO", then set the Power Switch to "AUTO" or "PRO.". Press **SP/LP** for more than 1 second. "SP" (Standard Play) provides higher picture and sound quality and is better for dubbing, while "LP" (Long Play) is more economical, providing twice the recording time.

NOTE:

If the recording mode is switched during recording, the playback picture will be blurred at the switching point.

Tape Length Setting

Set the tape length according to the length of the tape used.

1 ACCESS MENU SCREEN

First set the System Select Switch to "VIDEO", then set the Power Switch to "PRO.". Press **MENU**.

2 SELECT FUNCTION

Rotate the Select Dial to move the highlight bar to "TAPE LENGTH", then press it. The TAPE LENGTH Setting Menu appears.

3 SET TAPE LENGTH

Rotate the Select Dial to move the highlight bar to the correct setting. T30=30 minutes of recording time, T45=45 minutes, and T60=60 minutes (in SP).

- If you decide you want to return the tape length to the previous setting, rotate the Select Dial to move the highlight bar to "EXIT".

4 CLOSE MENU SCREEN

Press the Select Dial. The Menu Screen reappears with the highlight bar on "RETURN". Press the Select Dial again to close the Menu Screen.

NOTE:

The tape remaining time (⏪ pg. 17) displayed in the viewfinder is correct only if the correct tape length has been selected.

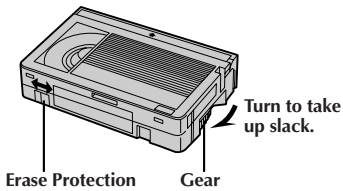
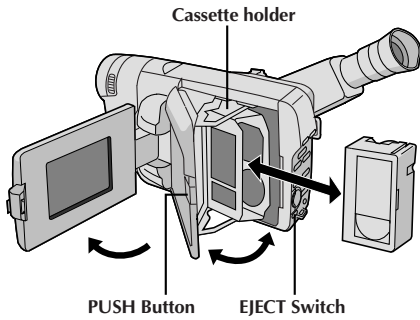

Loading/Unloading A Cassette

- 1 OPEN LCD MONITOR**
Open the LCD monitor to an angle of over 60 degrees.
- 2 OPEN CASSETTE HOLDER**
Slide **EJECT** until the holder opens. Do not use force to open.
- 3 INSERT/REMOVE CASSETTE**
Make sure the label is facing outward.
- 4 CLOSE CASSETTE HOLDER**
Press **PUSH** and make sure the holder is closed and locked.
- 5 CLOSE LCD MONITOR**
First make sure the holder is closed. Then close the LCD monitor.

NOTES:

- Closing the LCD monitor while the cassette holder is still open may cause damage to the LCD monitor.
- The cassette holder can't be opened unless a power supply is attached.
- Make sure that the tape is not slack when loading the cassette. If there is any slack, turn the gear on the cassette in the direction of the arrow to take up the slack.
- Make sure the Erase Protection tab is in the position that allows recording. If not, slide the tab. Some cassettes have removable tabs. If the tab has been removed, cover the hole with adhesive tape.
- The cassette holder cannot be opened while the camcorder is in the record mode.

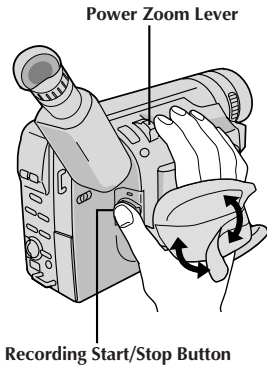

Grip Adjustment

- 1 EXPAND LOOP**
Separate the Velcro strip.
- 2 INSERT HAND**
Pass your right hand through the loop and grasp the grip.
- 3 ADJUST STRAP LENGTH**
Adjust so that your thumb and fingers can easily operate the Recording Start/Stop Button and Power Zoom Lever. Refasten the Velcro strip.

Viewfinder Adjustment

- 1 SELECT OPERATION MODE**
Set the Power Switch to "CAMERA" ("AUTO" or "PRO.").
- 2 POSITION VIEWFINDER**
Adjust the viewfinder manually for best viewability (see illustration on left).
- 3 ADJUST DIOPTR**
Turn the Dioptre Adjustment Control until the indications in the viewfinder are clearly focused.

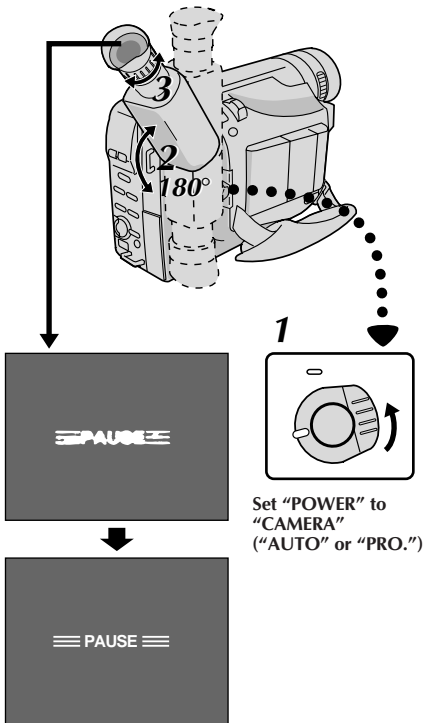

Shoulder Strap Attachment

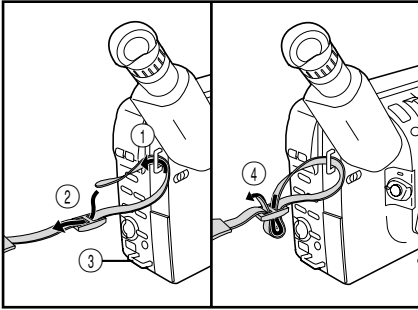

1 ATTACH STRAP

Following the illustration on left, thread the strap through the top of the eyelet (1), then fold it back and thread it through the buckle (2). Repeat the procedure to attach the other end of the strap to the other eyelet (3), making sure the strap is not twisted.

2 ADJUST LENGTH

Adjust as shown in the illustration on left (4).

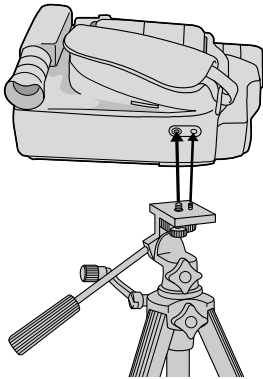

Tripod Mounting

1 ALIGN AND TIGHTEN

Align the screw and camera direction stud on the tripod with the camera's mounting socket and stud hole. Then tighten the screw.

CAUTION:

When using a tripod, be sure to open and extend its legs fully to stabilize the camcorder. To prevent damage to the unit caused by falling over, do not use a small-sized tripod.

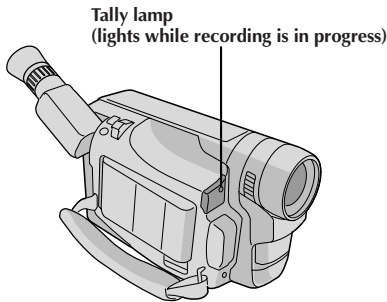
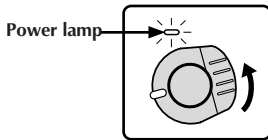
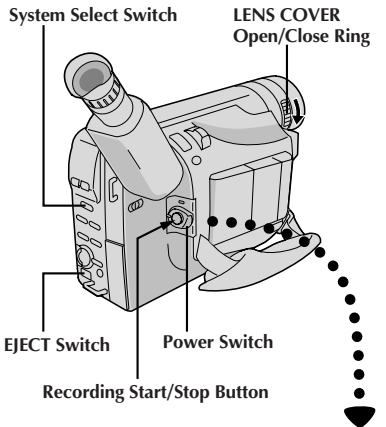
**NOTE:**

You should already have performed the procedures listed below. If not, do so before continuing.

- Power (☞ pg. 8)
- Recording Mode Setting (☞ pg. 12)
- Tape Length Setting (☞ pg. 12)
- Grip Adjustment (☞ pg. 14)
- Viewfinder Adjustment (☞ pg. 14)

1 LOAD A CASSETTE

First open the LCD monitor to an angle of over 60 degrees.

Slide **EJECT** to open the cassette holder, then insert the cassette with the label facing out. Press **PUSH** to ensure the holder is closed and locked.

Shooting While Watching The Viewfinder**2 ENTER RECORD-STANDBY MODE**

Make sure the LCD monitor is closed and locked.

Turn the **LENS COVER Open/Close Ring** to open the lens cover. Set the System Select Switch to "VIDEO", then set the Power Switch to "CAMERA" ("AUTO" or "PRO.").

- The power lamp lights and the camcorder enters the Record-Standby mode.
- The scene you are aimed at appears on the viewfinder screen, with the word "PAUSE" superimposed upon it.

3 START SHOOTING

Press the Recording Start/Stop Button.

- "REC" appears in the viewfinder while recording is in progress.

Power Switch Position

According to the Power Switch position you have selected, the following functions are available:

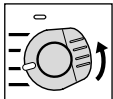

AUTO
(Full Auto mode):

Allows you to record using NO special effects or manual adjustments. Suitable for standard recording.

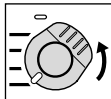

PRO.
(PRO. mode):

Allows you to set various recording functions using the menus. If you want more creative capabilities than full auto recording, try this mode.

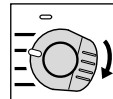

POWER OFF:

Allows you to switch off the camcorder.

Tape remaining time indicator

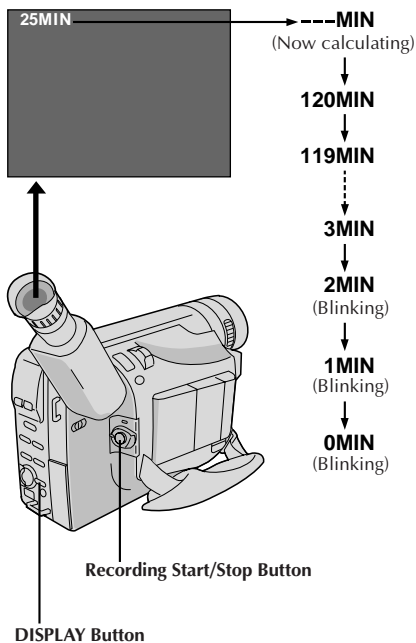

4 STOP RECORDING

Press the Recording Start/Stop Button again to stop recording.

- The camcorder re-enters the Record-Standby mode.

NOTES:

- When the Power Switch is set to "CAMERA" and the LCD monitor is opened at an angle of 60 degrees or more, the LCD monitor switches on and the viewfinder switches off automatically to save power.
- The cassette holder cannot be opened unless a power supply is attached.
- There may be a delay after you slide **EJECT** until the holder opens. Do not use force.
- The tape remaining time is only displayed in the viewfinder as shown.
- The remaining time indicated in the viewfinder is approximate.
- The time required to calculate the remaining tape length, and the accuracy of the calculation, may vary according to the type of tape used.
- The tape remaining time indicator is correct only if the correct tape length has been selected (☞ pg. 12).
- "TAPE END" appears when the tape reaches its end, and the power goes off automatically if left in this condition for 5 minutes. "TAPE END" also appears when a cassette whose tape is already at its end is loaded.
- If the Record-Standby mode continues for 5 minutes without performing Zoom or any other operations, the camcorder's power shuts off automatically. Set the Power Switch to "POWER OFF", and then back to "CAMERA" to turn the camcorder on again.
- If the Recording Start/Stop button is pressed after the Record-Standby mode has continued for over 5 minutes, recording may not start immediately.
- If you are recording on a cassette from the middle (such as when a tape is removed and re-inserted during recording), use the Retake function (☞ pg. 27) to find the end of the last recording so you don't erase any of it.
- The LENS COVER warning blinks for about 5 seconds when the camcorder is turned on with the cover closed.
- While shooting, sound is not heard from the speaker.
- To turn the tally lamp off during recording, refer to pgs. 34 and 36.

LCD Monitor/Viewfinder Indications

Press **DISPLAY** to make the following indications appear/disappear from the camcorder's display: cassette warning, tape remaining time, battery pack remaining power indicator and tape length indicator (☞ pg. 64, 65).

1 PRESS DISPLAY BUTTON

To turn off the indications, press **DISPLAY** for more than 1 second.

Press again for more than 1 second to make the indications reappear.

NOTE:

Even if the indications are off, the tape remaining time appears blinking when the tape is near its end, and the battery pack remaining power indicator appears blinking when the power is almost gone.

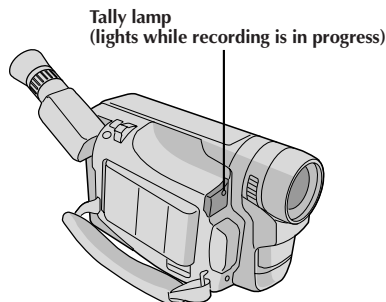
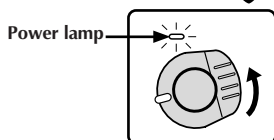
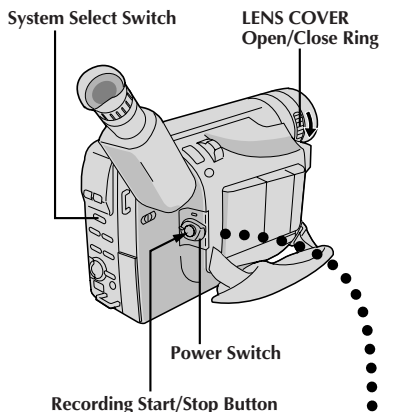
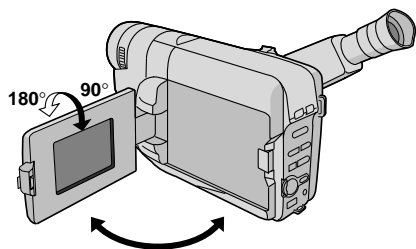

Shooting While Watching The LCD Monitor

Before the following steps, perform step 1 (pg. 16).

2 ENTER RECORD-STANDBY MODE

Make sure the LCD monitor is fully open. Turn the **LENS COVER Open/Close Ring** to open the lens cover. Set the System Select Switch to "VIDEO", then set the Power Switch to "CAMERA" ("AUTO" or "PRO.").

- The power lamp lights and the camcorder enters the Record-Standby mode.
- The scene you are aimed at appears in the LCD monitor, with the word "PAUSE" superimposed upon it.

3 START SHOOTING

Tilt the LCD monitor upward/downward for best viewability (pg. 19) and press the Recording Start/Stop Button.

- "REC" appears in the LCD monitor while recording is in progress.

4 STOP RECORDING

Press the Recording Start/Stop Button again to stop recording.

- The camcorder re-enters the Record-Standby mode.

NOTES:

- When you use the LCD monitor outdoors in direct sunlight, the LCD monitor may be difficult to see. If this happens, we recommend that you use the viewfinder (pg. 16).
- To turn the tally lamp off during recording, refer to pgs. 34 and 36.
- For other notes, refer to pg. 17.



Self-recording

Journalistic Shooting

In some situations different angles of shooting may be required for more dramatic results.

1 OPEN LCD MONITOR

Make sure the LCD monitor is fully open.

2 TILT LCD MONITOR

Tilt the LCD monitor in the most convenient direction.

- The LCD monitor can rotate almost full circle (270°: 90° downward, 180° upward).

Interface Shooting

The person you shoot can view himself/herself in the LCD monitor, and you can even shoot yourself while viewing your own image in the LCD monitor.

1 TILT LCD MONITOR UPWARD

Open the LCD monitor and tilt it upward to 180 degrees so that it faces forward.

- When the LCD monitor is tilted upward to an angle of over approx. 105 degrees, the monitor image is inverted vertically, and the viewfinder also switches on.

2 START RECORDING

Point the lens toward the subject (yourself when self-recording) and start recording.

- During Interface Shooting, the monitor image and indications do not appear inverted as they would when viewing a mirror.

NOTE:

The monitored image can be viewed on the LCD monitor and in the viewfinder.

Brightness Control

You can adjust the brightness of the LCD monitor by turning the **BRIGHT** Dial.

1 ADJUST BRIGHTNESS

If you want to brighten the image . . .

Turn the Dial towards "+".

If you want to darken the image . . .

Turn the Dial towards "-".

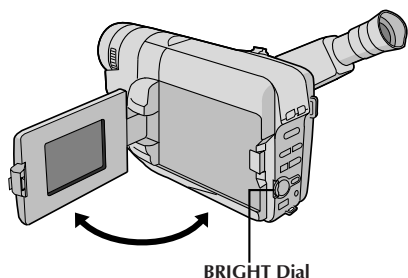

BRIGHT Dial

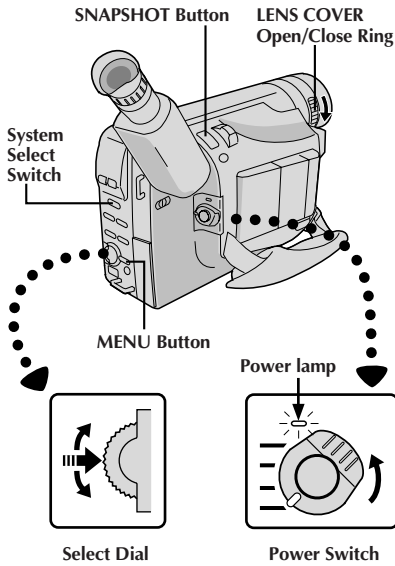

Display

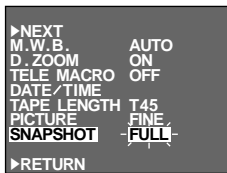

Menu Screen



SNAPSHOT Menu

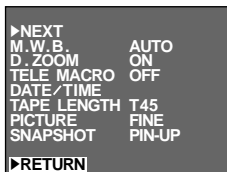

Menu Screen

Normal Screen

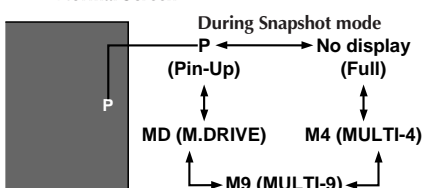

Basic Shooting

When shooting a still image, it is not recorded onto the tape, but it is stored in the camcorder's built-in memory in the selected Picture Mode. A stored still image data can be transferred to a PC, saved, and processed using a Paint Software program (☞ pg. 51).

A still image processed on the PC can be also inserted onto a tape (☞ pg. 51, 65).

MODE SELECTION

1 SELECT OPERATION SYSTEM AND MODE

Turn the **LENS COVER Open/Close Ring** to open the lens cover, then set the **System Select Switch** to "D.S.C.". Set the **Power Switch** to "PRO".

- The power lamp lights and an image appears.

2 SELECT PICTURE MODE

Do steps 2 and 3 of "OPERATION" on pg. 22. Set "PICTURE" to "FINE" or "STANDARD" in the Menu Screen as required.

- There are two modes: FINE allows you to shoot up to approx. 30 still images with higher resolution, and STANDARD allows you to shoot up to approx. 60 still images with lower resolution.

3 SELECT SNAPSHOT MODE

Rotate the **Select Dial** to move the highlight bar to "SNAPSHOT", and press it. The **SNAPSHOT Menu** appears.

Rotate the **Select Dial** to move the highlight bar to the appropriate mode among the 5 Snapshot modes (☞ pg. 21), and press it. Selection is complete.

4 CLOSE MENU SCREEN

The **Menu Screen** reappears with the highlight bar on "RETURN". Press the **Select Dial** again to close the **Menu Screen**.

STILL IMAGE STORAGE

1 TAKE SNAPSHOT

Press **SNAPSHOT**.

- Regardless of the **Power Switch** position ("AUTO" or "PRO."), Snapshot recording takes place using the selected Snapshot mode.
- A still image is stored in the built-in memory and displayed for approx. 2 seconds. While the still image remains displayed, that image is in the process of being stored in memory, and it is therefore impossible to take another shot during that time. When the still image disappears and the scene you are currently aimed at appears on the screen, you may take another shot.
- The remaining number of shots available is displayed.

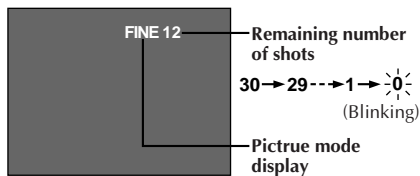

NOTES:

- The remaining number of shots varies according to the selected Picture Mode. In the "STANDARD" mode, twice as many still images can be shot as in the "FINE" mode.
- Some sample images have been stored in the built-in memory at the factory. If you wish to delete them, first remove the "Protect" function (☞ pg. 55), then perform the "Delete" function (☞ pg. 56).
- When the Power Switch is set to "AUTO", it is not possible to select the Snapshot mode. You can use the Snapshot mode you selected in the "PRO." mode.
- If a Snapshot is taken while the camcorder is in the WIDE mode (☞ pg. 35), the Snapshot image is recorded without the black bars at the top and bottom of the screen.



FULL*
(Snapshot mode with no frame)



PIN-UP*
(Pin-Up mode)

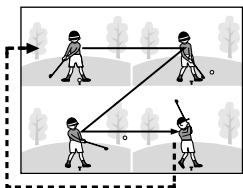

MULTI-4**
(Multi-Analyzer 4)

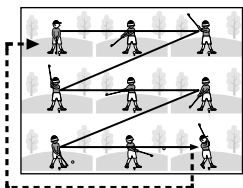

MULTI-9**
(Multi-Analyzer 9)



M. DRIVE ✓
(Motor Drive mode)

- * There is a momentary camera shutter-type blackout together with the image.
- ** Continuous camera shutter-type blackout takes place 4 or 9 times with the image, like serial photography, then the 4 or 9 still images you took are displayed.
- ✓ Stores 4 still images continuously for approx. 2 seconds. During still image storage, "MD" blinks and the 4 still images are displayed in the order that you took them. There is no sound effect of a shutter closing.

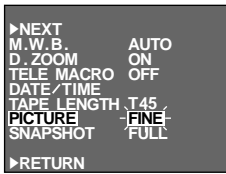
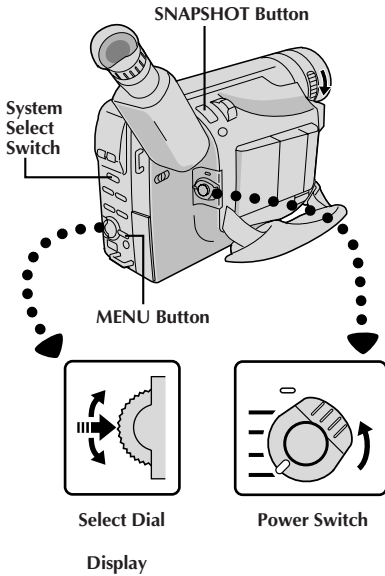

Menu Screen

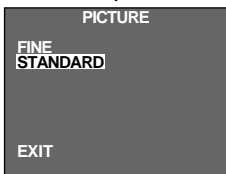

PICTURE Menu

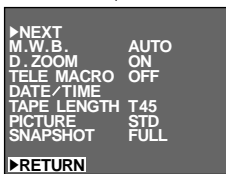

Menu Screen

Normal Screen

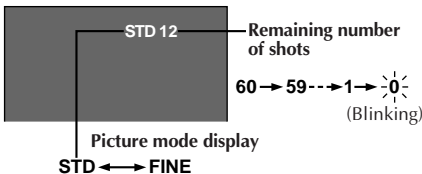

FEATURE: Picture Mode Setting

PURPOSE:

There are two image settings you can choose from when storing in the camcorder's memory: FINE and STANDARD. FINE allows you to shoot up to approx. 30 still images in a format based on JPEG (Joint Photographic Experts Group) format. Since the quality of image is better than "STANDARD", "FINE" is more suitable for post-production on a PC. "STANDARD" allows you to shoot up to approx. 60 still images in a format based on JPEG (Joint Photographic Experts Group) format. Since in this mode, twice as many still images can be shot as in the "FINE" mode, select this mode when you wish to shoot many still images.

OPERATION:

- 1) Turn the **LENS COVER** Open/Close Ring to open the lens cover, and set the System Select Switch to "D.S.C.". Set the Power Switch to "PRO."
- 2) Press **MENU**. The Menu Screen appears.
 - If you wish the Picture Mode to return to the previous setting, rotate the Select Dial to move the highlight bar to "RETURN".
- 3) Rotate the Select Dial to move the highlight bar to "PICTURE", and press it. The PICTURE Menu appears. Rotate the Select Dial to move the highlight bar to "FINE" or "STANDARD", and press it. Selection is complete.
- 4) The Menu Screen reappears with the highlight bar on "RETURN". Press the Select Dial again to close the Menu Screen.

NOTES:

- The picture mode's factory-preset is FINE.
- Some sample images have been stored in the built-in memory at the factory.
If you wish to delete them, first remove the "Protect" function (☞ pg. 55), then perform the "Delete" function (☞ pg. 56).
- To store the still images you shot, we recommend that you transfer them to a computer and save them on disk (☞ pg. 51), or transfer them to a VCR connected to the camcorder and record them onto a tape.
- When the Power Switch is set to "CAMERA" ("AUTO" or "PRO.") and the LCD monitor is opened at an angle of 60 degrees or more, the LCD monitor switches on and the viewfinder switches off automatically to save power. When you use the LCD monitor outdoors in direct sunlight, the LCD monitor may be difficult to see. If this happens, we recommend that you use the viewfinder.
- When the remaining number indicator displays "0" (blinking), it is not possible to continue storing pictures until you delete some shots to make room for new ones. Perform "DELETE" function in the Menu Screen to remove pictures you do not need (☞ pg. 56).
- The Picture Mode can be switched to either "FINE" or "STANDARD". Since the remaining number of shots available depends on the selected Picture Mode, switching the Picture Mode will vary this number.
- The LENS COVER warning blinks for approx. 5 seconds when the camcorder is turned on with the cover closed.
- When **SNAPSHOT** is pressed with the System Select Switch set to "VIDEO", the picture is stored in the camcorder's built-in memory (in the Snapshot mode selected in the "VIDEO" system) and also onto the tape (if a tape is in the camcorder) (☞ pg. 24).
- When you shoot in a dark environment, the still image will become coarse and its true colors will be lost.

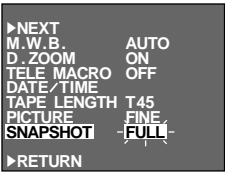
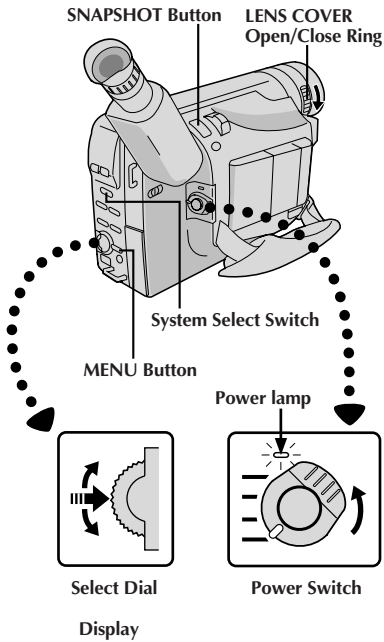

Menu Screen



SNAPSHOT Menu

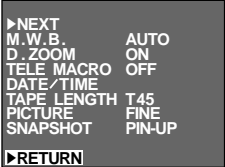

Menu Screen



P
(Pin-Up)
↕
No display
(Full)

Snapshot

This interesting feature lets you record two types of digital still images that look like photographs on a tape, as well as keeping them in the camcorder's built-in memory. It is a great way to spice up footage of events such as parties, weddings and graduations.

SNAPSHOT MODE SELECTION

1 SELECT OPERATION SYSTEM AND MODE

Turn the **LENS COVER Open/Close Ring** to open the lens cover, and set the **System Select Switch** to "VIDEO". Set the **Power Switch** to "PRO."

- The power lamp lights and the camcorder enters Record-Standby mode.

2 SELECT SNAPSHOT MODE

Press **MENU**. The Menu Screen appears.

Rotate the **Select Dial** to move the highlight bar to "SNAPSHOT", and press it. **SNAPSHOT Menu** appears.

Rotate the **Select Dial** to move the highlight bar to "FULL" or "PIN-UP", and press it. Selection is complete.

3 CLOSE MENU SCREEN

The Menu Screen reappears with the highlight bar on "RETURN". Then press the **Select Dial** to close the Menu Screen.

SNAPSHOT



Display (ex. Pin-Up)



①

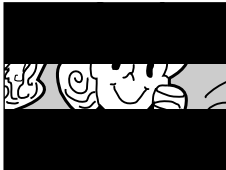

②



③

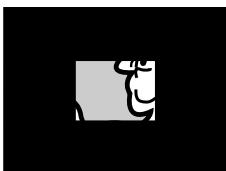

④



⑤



FULL
(Snapshot mode with
no frame)



PIN-UP
(Pin-Up mode)

SNAPSHOT RECORDING

1 TAKE SNAPSHOTPress **SNAPSHOT**.

- Regardless of the Power Switch position ("AUTO" or "PRO."), Snapshot recording takes place using the selected Snapshot mode.
- A still image is recorded onto the tape and into the camcorder's built-in memory.
- First there is a momentary camera shutter-type blackout together with the sound effect of a shutter closing, then a still image appears. The scene you are currently aimed at starts in the center of a black screen and wipes in toward the corners. The screen changes as shown in the illustrations ① to ⑤ and the screens ① to ⑤ are recorded onto the tape in the selected mode. Only the still image ③ is stored in the built-in memory in the selected mode, then the camcorder resumes normal recording.

If you press during Record-Standby mode . . .

.... the screens ① to ③ are recorded onto the tape in the selected mode. Then the camcorder re-enters the Record-Standby mode.

NOTES:

- When the remaining number indicator displays "0" (blinking), the still image will be recorded onto the tape but not in the built-in memory. If you wish to store a still image in the built-in memory, see pg. 56.
- The Picture Mode can be switched to either "FINE" or "STANDARD". Since the remaining number of shots available depends on the selected Picture Mode, switching the Picture Mode will vary this number.
- If **SNAPSHOT** is pressed with the System Select Switch set to "D.S.C.", see pg. 20.
- Image data stored in the camcorder's built-in memory can be transferred to a Windows® PC and saved using the provided image transfer software, Picture Navigator (see pg. 51). The image data transferred to a Windows® PC can also be further processed using Mr. Photo Gold.
- If a snapshot is taken while the camcorder is in the WIDE mode (see pg. 35), the snapshot image is recorded without the black bars at the top and bottom of the screen.
- When a Snapshot is taken in a dark environment, the still image recorded onto the tape and stored in memory will become coarse and its true colors will be lost.

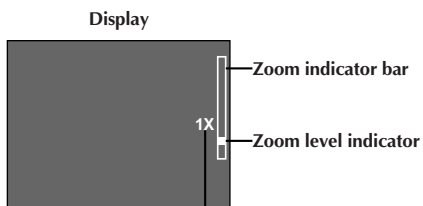
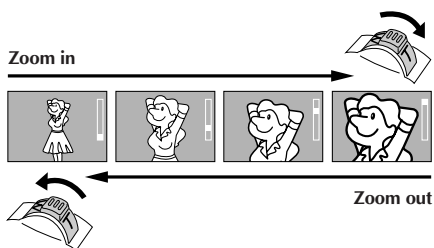

Approximate zoom ratio

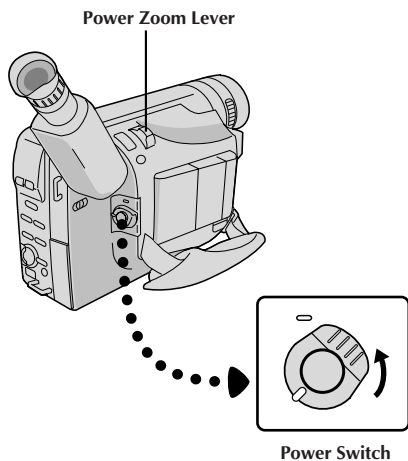
**FEATURE: Zooming****PURPOSE:**

To produce the zoom in/out effect, or an instantaneous change in image magnification.

Digital circuitry extends the maximum magnification offered by optical zoom. This system is called Digital Zoom.

OPERATION:**Zoom In**

Push the Power Zoom Lever towards "T".

Zoom Out

Push the Power Zoom Lever towards "W".

- The harder you push the Power Zoom Lever, the quicker the zoom action.

NOTES:

- Focusing may become unstable during Zooming. In this case, set the zoom while in Record-Standby, lock the focus by using the manual focus (☞ pg. 39), then zoom in or out in Record mode.
- The zoom level indicator (■) moves during zoom. Once the zoom level indicator reaches the top of the zoom indicator bar, all magnification from that point is through digital processing.
- When using Digital Zoom, the quality of image may suffer. To deactivate Digital Zoom, set "D.ZOOM" to "OFF" in the Menu Screen (☞ pg. 35).

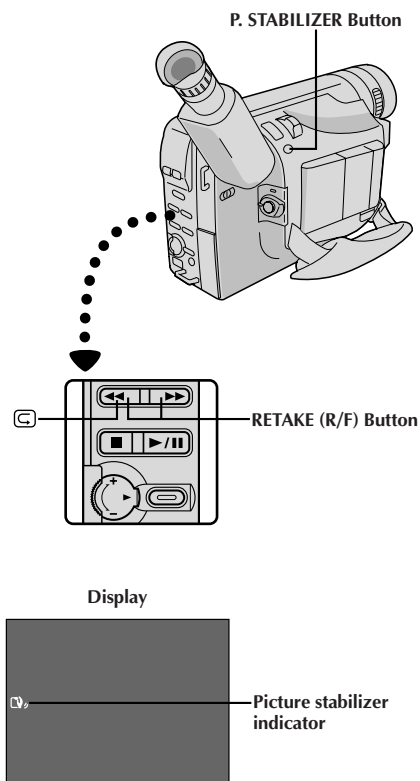

FEATURE: Quick Review

PURPOSE:

To check the end of the last recording.

OPERATION:

- 1) Press "⏮" and release quickly during the Record-Standby mode.
 - Tape is rewound for about 1 second and played back automatically, then pauses in Record-Standby mode for the next shot.

NOTE:

Distortion may occur at the start of playback. This is normal.

FEATURE: Retake

PURPOSE:

To re-record certain segments.

OPERATION:

- 1) Make sure the camcorder is in the Record-Standby mode.
- 2) Press and hold either **RETAKE** to reach the start point for new recording. Pressing "F" forwards the tape and pressing "R" reverses it.
- 3) Press the Recording Start/Stop Button to start recording.

NOTE:

Noise bars appear and pictures may become monochrome or darken during Retake. This is normal.

FEATURE: Picture Stabilizer

PURPOSE:

To compensate for unstable images caused by camera-shake, particularly at high magnification.

OPERATION:

- 1) Press **P. STABILIZER**. "Ⓢ" appears.
 - To switch off the Picture Stabilizer, press **P. STABILIZER**. The indicator disappears.

NOTES:

- Accurate stabilisation may not be possible if hand shake is excessive, or under the following conditions:
 - When shooting subjects with vertical or horizontal stripes.
 - When shooting dark or dim subjects.
 - When shooting subjects with excessive backlighting.
 - When shooting scenes with movement in various directions.
 - When shooting scenes with low-contrast backgrounds.
- Switch off the Picture Stabilizer when recording with the camcorder on a tripod.
- The "Ⓢ" indicator appears blinking if the Stabilizer cannot be used.

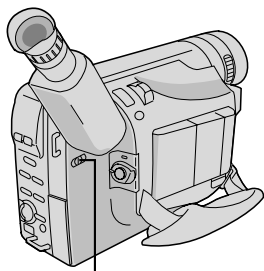

LIGHT OFF/AUTO/ON Switch

DANGER

- The video light can become extremely hot. Do not touch it either while in operation or soon after turning it off, otherwise serious injury may result.
- Do not place the camcorder into the carrying case immediately after using the video light, since it remains extremely hot for some time.
- When operating, keep a distance of about 30 cm. between the video light and people or objects.
- Do not use near flammable or explosive materials.
- It is recommended that you consult your nearest JVC dealer for replacing the video light.

FEATURE: Video Light**PURPOSE:**

To brighten the scene when natural lighting is too dim.

OPERATION:

1) Set the **LIGHT OFF/AUTO/ON** Switch as required:

OFF : Turns off the light.

AUTO : Automatically turns on the light when the camcorder senses insufficient lighting on the subject.

ON : Always keeps the light on as long as the camcorder is turned on.

- The video light can only be used with the camcorder's power on.
- It is recommended to set the white balance (☞ pg. 40) to when you use the video light.
- When not using the video light, turn it off to save battery power.

NOTES:

- Even if the battery indicator () does not blink if the battery pack's charge is low, the camcorder may turn off automatically when you turn on the video light, or when you start recording with the video light turned on.
- When the **LIGHT OFF/AUTO/ON** Switch is set to "AUTO":
 - Depending on the lighting conditions, the video light may keep turning on and off. In this case, manually switch the light on or off using the **LIGHT OFF/AUTO/ON** switch.
 - While the "Sports" or "High Speed Shutter" mode (☞ pg. 31) is engaged, the light is likely to stay on.
 - While the "Twilight" mode (☞ pg. 31) is engaged, the light will not activate.

[Ex.: Fader]

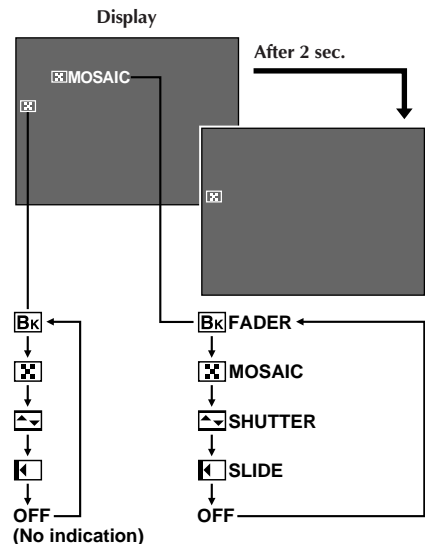
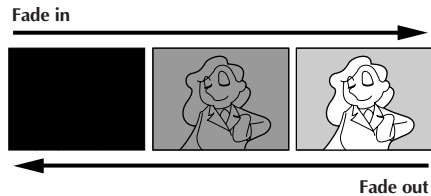

Fade/Wipe

These effects let you make pro-style scene transitions. Fade- or wipe-in works at recording start, and fade- or wipe-out works at recording end.

1 SELECT OPERATION SYSTEM AND MODE

Set the System Select Switch to "VIDEO", and set the Power Switch to "PRO."

2 ENGAGE FADE- OR WIPE-STANDBY MODE

Press **EFFECT** to cycle through the modes as shown at left. Once the desired mode appears, it is selected and reserved.

- The selected mode's name and its indication are displayed for approx. 2 seconds. Then the name disappears, and only the indication remains.

3 START OR END RECORDING

Press the Recording Start/Stop Button to activate fade-in/out or wipe-in/out.

4 TO CANCEL FADE- OR WIPE-STANDBY MODE

Press **EFFECT** repeatedly until "OFF" appears.

- "OFF" is displayed for approx. 2 seconds and the fade/wipe standby mode is canceled.

Bk FADER

Fades in/out to a black screen.

MOSAIC (Fader)

Gradually turns/returns the picture into/from a mosaic pattern.

SHUTTER (Wipe)

A black screen moves in from the top and bottom, closing over the image like a shutter, or a new image pushes open the black screen vertically from the centre.

SLIDE (Wipe)

A black screen moves in from the left to gradually cover the image, or a new image moves in from right to left.

NOTES:

- Pressing and holding the Recording Start/Stop Button allows you to vary the length for the image during fade in/out or wipe in/out.
- The screen becomes slightly reddish when the Fade/Wipe is used with Sepia (pg. 31).
- With the Electronic fog filter mode (pg. 31) engaged, the image fades in/out to a white screen.
- Even if you start shooting with the Fade/Wipe indication displayed during Digital Still Camera Shooting, the Fade/Wipe does not function.

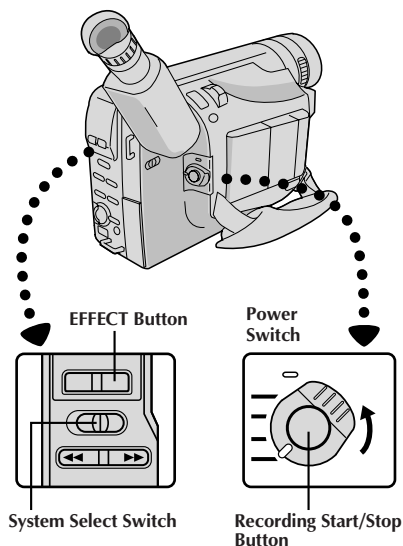

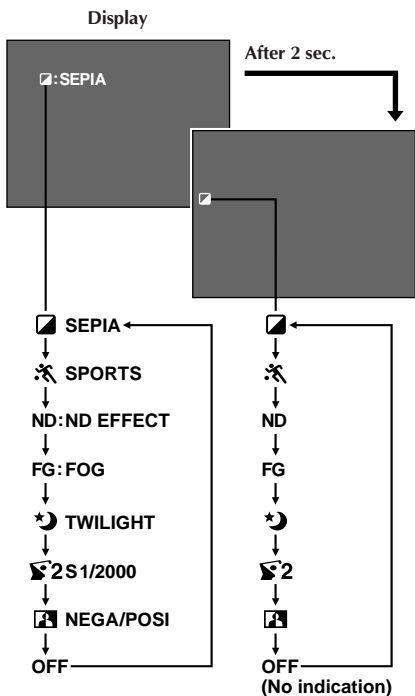

Programme AE With Special Effects

All you have to do to access any of the variety of shooting effects is press **P.AE**.

1 SELECT OPERATION SYSTEM AND MODE

Set the System Select Switch to "D.S.C." or "VIDEO", and set the Power Switch to "PRO."

2 SELECT MODE

Press **P.AE** to cycle through the modes as shown on the left.

- The selected mode's name and its indication are displayed for approx. 2 seconds. Then the name disappears, and only the indication remains. The mode is activated.

NOTES:

- Only one mode can be engaged at a time.
- The screen becomes slightly reddish when the Fade/Wipe (pg. 29) is used in the Sepia mode.
- The screen becomes slightly dark in the High Speed Shutter mode. Use in well-lit situations.
- In the "High Speed Shutter" or "Sports" modes, picture colour may be adversely affected if the subject is lit by alternating discharge-type light sources such as fluorescent or mercury-vapour lights.

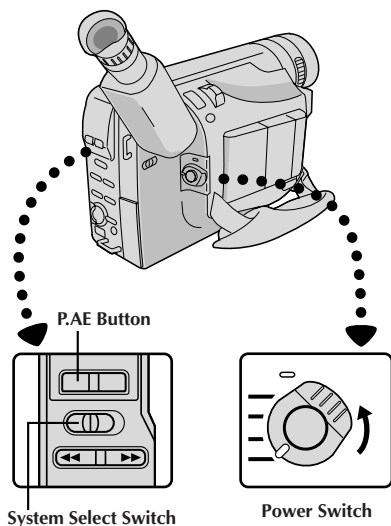

Display

Mode

**Sepia**

The scene being shot is recorded in sepia-tinted (reddish-brown) monochrome, giving the effect of an older movie. Use together with Wide (📖 pg. 35) for the authentic look of a classic Hollywood movie.

- When the Power Switch is set to “D.S.C.”, the scene is stored in black-and-white in the camcorder’s memory.

**Sports**

High shutter speed clearly captures fast-moving action.

**ND Effect**

A black mist darkens the picture, as when an ND filter is used. Helps to counter the effects of glare on the subject.

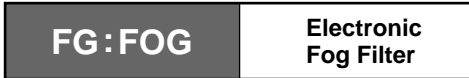
**Electronic Fog Filter**

Makes the picture look misty white, as when an external fog filter is attached to the lens. Softens the image and gives it a “fantasy” look.

Display

Mode

**Twilight**

Dusk, twilight scenery, fireworks, etc., look more natural and dramatic. The following happens when Twilight mode is selected:

- Auto gain control is turned off.
- White Balance is set to “☀️” (FINE day mode), but can also be manually changed to another mode (📖 pg. 40).
- Auto Focus becomes available only in the range of 10 m to infinity. To focus when the subject-to-camera distance is less than 10 m, use manual focusing (📖 pg. 39).

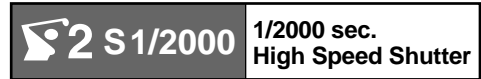
**High-Speed Shutter (1/2000s.)**

Captures faster action than Sports mode.

**Nega/Posi (Negative/Positive)**

The colours of a picture are reversed.

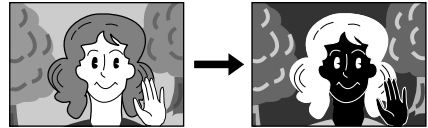
**NEGA POSI mode**

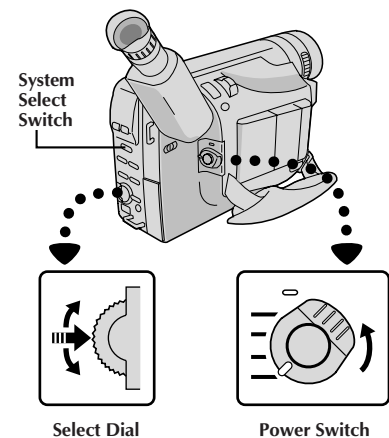

Display

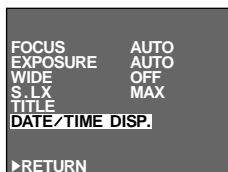

Menu Screen



DATE/TIME DISP. Menu

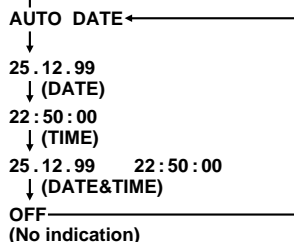
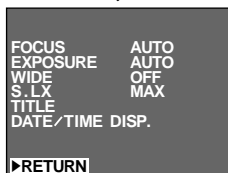

Date/Time Insert

This feature allows you to display the date and time on the LCD monitor, in the viewfinder, or on a connected colour monitor, as well as to record them manually or automatically.

1 SELECT OPERATION SYSTEM AND MODE

Set the System Select Switch to "VIDEO", and set the Power Switch to "PRO."

2 ACCESS MENU SCREEN

Press the Select Dial to display the Menu Screen.

3 ACCESS "DATE/TIME DISP." MENU

Move the highlight bar to "DATE/TIME DISP." by rotating the Select Dial while in Record-Standby. Then press it to display the DATE/TIME DISP. Menu.

4 SELECT THE DESIRED MODE

Move the highlight bar to the desired mode by rotating the Select Dial, then press it. The desired mode is activated.

- You should have already performed the Date/Time Setting procedure (pg. 11). If you haven't, do so first.

5 CLOSE MENU SCREEN

The Menu Screen reappears with the highlight bar on "RETURN". Then press the Select Dial to close the Menu Screen.

NOTES:

DISPLAY

- The selected display can be recorded.
- If you do not want to record the display, select the OFF mode before shooting.
- Even if you shoot with the date/time displayed during Digital Still Camera Shooting, they will not be recorded.

AUTO DATE

- Your camcorder automatically records the date for about 5 seconds after recording is initiated in the following situations:
 - After changing the date.
 - After loading a cassette.
 - After Auto Date Record mode is selected by rotating the Select Dial.
- In this mode, the date is replaced after 5 seconds with "AUTO DATE" but this is not recorded.

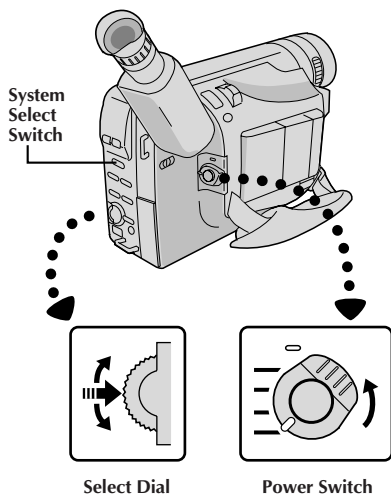

Display

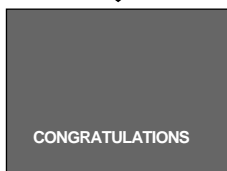
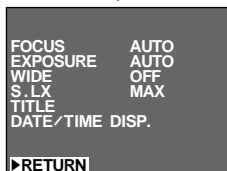
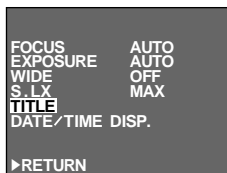

Instant Titles

The camcorder has eight preset titles in memory. You can superimpose one of them over a picture as shown in the illustration on left.

1 SELECT OPERATION SYSTEM AND MODE

Set the System Select Switch to "VIDEO", and set the Power Switch to "PRO."

2 ACCESS MENU SCREEN

Press the Select Dial to display the Menu Screen.

3 ACCESS "TITLE" MENU

Move the highlight bar to "TITLE" by rotating the Select Dial while in Record-Standby. Then press it to display the TITLE Menu.

4 SELECT THE DESIRED MODE

Move the highlight bar to the desired mode by rotating the Select Dial, then press it. The desired mode is activated.

- If you wish to make the title indication disappear, select "OFF".

5 CLOSE MENU SCREEN

The Menu Screen reappears with the highlight bar on "RETURN". Then press the Select Dial to close the Menu Screen.

NOTE:

Even if you shoot with the Title displayed during Digital Still Camera Shooting, this is not recorded.

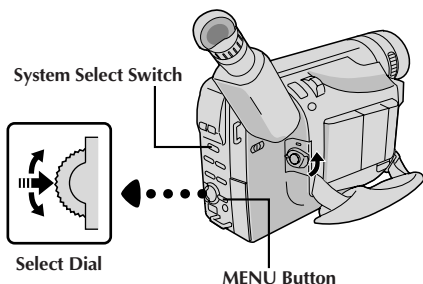

Display
(ex. Menu Screen available
using the MENU Button)

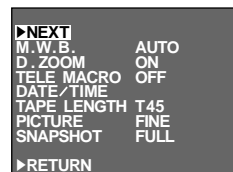

Menu Screen 1

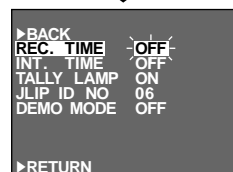

Menu Screen 2

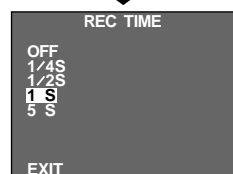
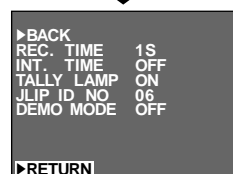
Setting Menu
(ex. REC TIME)

Normal Screen



Using Menu For Detailed Adjustment

This camcorder is equipped with an easy-to-use, on-screen menu system that simplifies many of the more detailed camcorder settings.

1 SELECT OPERATION SYSTEM AND MODE

The operation system depends on the function you wish to select.

Set the System Select Switch to "VIDEO" or "D.S.C." according to each function's "*/**" explanation described at the bottom of pages 35 and 36, and set the Power Switch to "PRO".

2 ACCESS MENU SCREEN

Menu access depends on the function you select.

If you select the functions from the "Menu Screen Available Using The Select Dial" described on pg. 35 . . .

.... press the Select Dial. The Menu Screen appears.

If you select the functions from the "Menu Screen Available Using The MENU Button" described on pg. 35 and 36 . . .

.... press MENU. The Menu Screen appears.

3 SELECT FUNCTION

Rotate the Select Dial to place the highlight bar on the desired function.

- To go from Menu Screen 1 to Menu Screen 2, rotate the Select Dial to "NEXT" and press it. To go back to Menu Screen 1 from Menu Screen 2, rotate the Select Dial to "BACK", and press it.
- If the setting you want cannot be found in the Menu Screen, place the highlight bar on "RETURN", then go to step 6.

4 MAKE SETTING

Press the Select Dial. The setting procedure depends on the function you select.

If you select "FOCUS", "EXPOSURE", "TITLE", "DATE/TIME DISP.", "DATE/TIME", "PICTURE" or "SNAPSHOT": . . .

.... see respective pages (FOCUS: pg. 38, 39,

EXPOSURE: pg. 37, TITLE: pg. 33,

DATE/TIME DISP.: pg. 32, DATE/TIME: pg. 11,

PICTURE: pg. 22, SNAPSHOT: pg. 20, 25).

If you select "WIDE", "D.ZOOM", "TELE MACRO" or "DEMO MODE" . . .

.... the selected function's parameter starts blinking.

Rotate the Select Dial until the desired parameter appears. Go to step 5.

If you select "JLIP ID NO." . . .

.... press the Select Dial so that the number blinks, then rotate it until the desired number appears, and press it. Then rotate the Select Dial to move the highlight bar to "EXIT".

If you select any other functions . . .

.... rotate the Select Dial to move the highlight bar to the desired setting.

- If you decide you want to return to the previous setting, rotate the Select Dial to move the highlight bar to "EXIT".

5 END SETTING

Press the Select Dial. The Menu Screen reappears with the highlight bar on "RETURN".

6 CLOSE MENU SCREEN

Press the Select Dial. The normal screen reappears.

NOTE:

No menu functions except "FOCUS" and "EXPOSURE" are available while in the Record mode.



MENU SCREEN EXPLANATIONS

Menu Screen Available Using The Select Dial

FOCUS	AUTO	Adjusts focus automatically.
	MANU	Allows you to adjust focus manually (☞ pg. 38, 39).
EXPOSURE	AUTO	Adjusts exposure automatically.
	MANU	Allows you to adjust exposure manually (☞ pg. 37).
WIDE	OFF	Does not display black bars.
	ON	Allows you to record black bars at the top and bottom of the screen to produce a cinema-like “wide-screen” effect. If a snapshot (☞ pg. 20, 24) is taken while the camcorder is in the WIDE mode, the snapshot image is recorded without the black bars at the top and bottom of the screen.
S.LX	MAX	To record a subject in a darkly lit environment, when it is more convenient to shoot the subject with a brighter image even if the picture becomes slightly coarse.
	NORMAL	To record a subject in a dimly lit environment, when it is more convenient to shoot with a less coarse picture although the subject becomes slightly dark.
	OFF	Allows you to shoot dark scenes with no picture brightness adjustment.
TITLE*	Allows you to superimpose one of eight preset titles (☞ pg. 33).	
DATE/TIME DISP.*	Makes the date/time settings appear in the camcorder or on a connected monitor (☞ pg. 32).	

Menu Screen Available Using The MENU Button

This Menu Screen cannot be accessed while recording.

M.W.B.	AUTO	This camcorder's Automatic Colour Temperature system senses the colour temperature of the ambient lighting for automatic white balance adjustment. However, precise colour adjustment is not possible under the following conditions: <ul style="list-style-type: none"> • When an object is in various shades of the same colour. • When a predominantly red or brown object is being shot outdoors. In these cases, use the camcorder's built-in preset filters for white balance adjustment (☞ pg. 40, 41).
	 : FINE	
	 : CLOUD	
	 : HALOGEN	
	MWB	
D. ZOOM	ON	Allows you to use the Digital Zoom. By digitally processing and magnifying images, zooming is possible from 16 times (the optical zoom limit), to a maximum of 50 times digital magnification.
	OFF	Digital Zoom is not available. Only optical zoom (maximum 16x magnification) can function. When set to “OFF” during Digital Zoom, zoom magnification changes to 16x.

* Activated only with the System Select Switch set to “VIDEO”. If the System Select Switch is set to “D.S.C.”, this function will not be activated although the highlight bar will move on the Menu Screen like the setting procedure.

Functions listed without an asterisk are available with the System Select Switch set to either “D.S.C.” or “VIDEO”.

 : Factory-preset

CONTINUED ON NEXT PAGE

Menu Screen Available Using The MENU Button (cont.)

TELE MACRO	OFF	Usually the distance to a subject where the lens is in focus depends on the zoom magnification. Unless there is a distance of more than 1m to the subject, the lens is out of focus at the maximum telephoto setting. When set to "ON", you can shoot a subject as large as possible at a distance of approx. 60 cm. • Depending on the zoom position, the lens may go out of focus.
	ON	
DATE/TIME	Allows you to set the current date and time (☞ pg. 11).	
TAPE LENGTH*	Allows you to set the tape length depending on the tape used (☞ pg. 12).	
PICTURE**	Allows you to select the image setting "FINE" or "STD" when storing in the camcorder's memory (☞ pg. 22).	
SNAPSHOT	FULL	Displayed with the System Select Switch set to either "VIDEO" (☞ pg. 24) or "D.S.C." (☞ pg. 21).
	PIN-UP	
	MULTI-4	Displayed only with the System Select Switch set to "D.S.C." (☞ pg. 21).
	MULTI-9	
M.DRIVE		
REC TIME*	This feature allows you to set the parameters for Animation and Time-Lapse recording (☞ pg. 43).	
INT. TIME	This feature allows you to set the parameters for Self-Timer (☞ pg. 42) and Time-Lapse recording (☞ pg. 43).	
TALLY LAMP*	OFF	The tally lamp remains off at all times.
	ON	The tally lamp comes on to signal the start of recording.
JLIP ID NO.	This number is necessary when connecting the camcorder to a device such as a computer using the J terminal (JLIP). The numbers range from 01 to 99. Factory setting is 06.	
DEMO MODE*	OFF	Automatic demonstration will not take place.
	ON	Demonstrates certain functions such as Fade/Wipe, etc. When "DEMO MODE" is set to "ON" and the Menu Screen is closed, the demonstration starts. NOTES: • When a tape whose Erase Protection tab is in the position that allows recording is loaded in the camcorder, demonstration is not available. • By turning off the camcorder or inserting a tape whose Erase Protection tab is in the position that allows recording into it, "DEMO MODE" is set to "OFF" automatically. • During the demonstration, all functions except zoom are disabled.

* Activated only with the System Select Switch set to "VIDEO". If the System Select Switch is set to "D.S.C.", this function will not be activated although the highlight bar will move on the Menu Screen like the setting procedure.

** Activated only with the System Select Switch set to "D.S.C.". If the System Select Switch is set to "VIDEO", this function will not be activated although the highlight bar will move on the Menu Screen like the setting procedure.

Functions listed without an asterisk are available with the System Select Switch set to either "D.S.C." or "VIDEO".

: Factory-preset

Exposure Control

This feature automatically adjusts the iris for the best available picture quality, but you can override and make the adjustment manually.

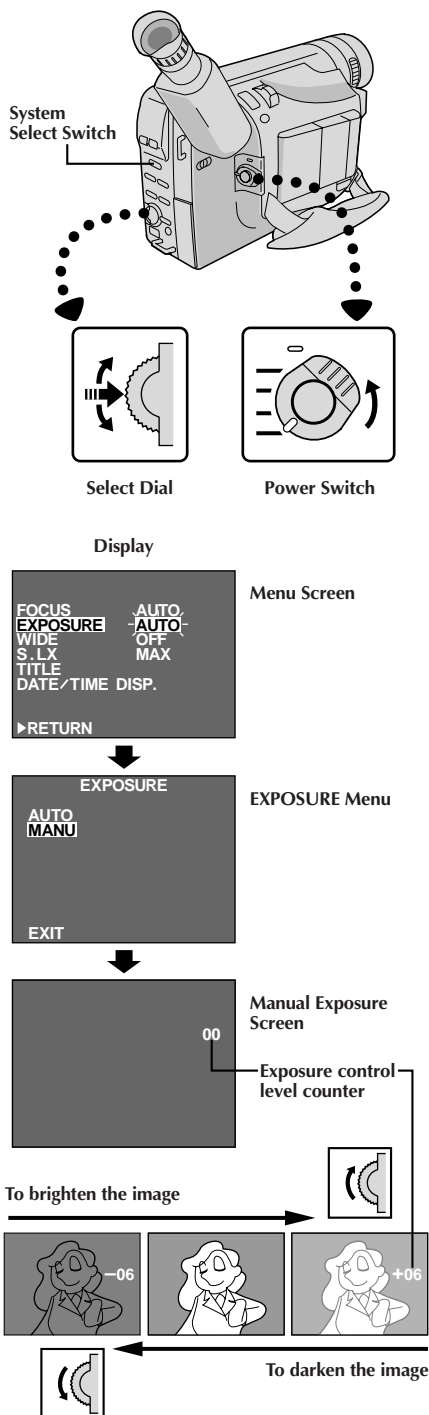

1 SELECT OPERATION SYSTEM AND MODE

Set the System Select Switch to "D.S.C." or "VIDEO", and set the Power Switch to "PRO."

2 ACCESS MENU SCREEN

Press the Select Dial to display the Menu Screen.

3 ACCESS "EXPOSURE" MENU

Rotate the Select Dial to move the highlight bar to "EXPOSURE" and press it.

4 ACCESS MANUAL EXPOSURE

Rotate the Select Dial to move the highlight bar to "MANU", then press it. "00" (exposure control level counter) appears.

5 ADJUST EXPOSURE

To brighten the image . . .

.... rotate the Select Dial upward. The exposure control level counter increases (maximum +06).

Go to step 6.

To darken the image . . .

.... rotate the Select Dial downward. The exposure control level counter decreases (maximum -06).

Go to step 6.

6 END ADJUSTMENT OF EXPOSURE

Press the Select Dial. The Menu Screen reappears with the highlight bar on "RETURN".

7 CLOSE MENU SCREEN

Press the Select Dial. The Menu Screen disappears and the exposure control level counter reappears to indicate the exposure is adjusted.

NOTES:

- To return to the factory setting, select "AUTO" in step 4.
- To re-adjust exposure, repeat the procedure from step 2.

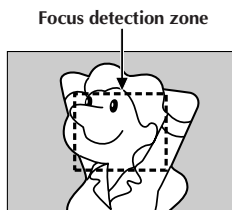

Focusing

AUTO FOCUS

The camcorder's Full Range AF system offers continuous shooting ability from close-up to infinity. However, correct focus may not be obtainable in the situations listed below (in these cases use manual focusing):

- When two subjects overlap in the same scene.
- When illumination is low.*
- When the subject has no contrast (difference in brightness and darkness), such as a flat, one-colour wall, or a clear, blue sky.*
- When a dark object is barely visible in the viewfinder.*
- When the scene contains minute patterns or identical patterns that are regularly repeated.
- When the scene is affected by sunbeams or light reflecting off the surface of a body of water.
- When shooting a scene with a high-contrast background.

* The low-contrast warning "▲▲" appears.

NOTES:

- If the lens is smeared or blurred, accurate focusing is not possible. Keep the lens clean, wiping with a piece of soft cloth if it gets dirty. When condensation occurs, wipe with a soft cloth or wait for it to dry naturally.
- When shooting a subject close to the lens, zoom out first (☞ pg. 26). If zoomed in in the auto focus mode, the camcorder could automatically zoom out depending on the distance between the camcorder and the subject. When Tele Macro (☞ pg. 36) is activated, the camcorder will not zoom out automatically.

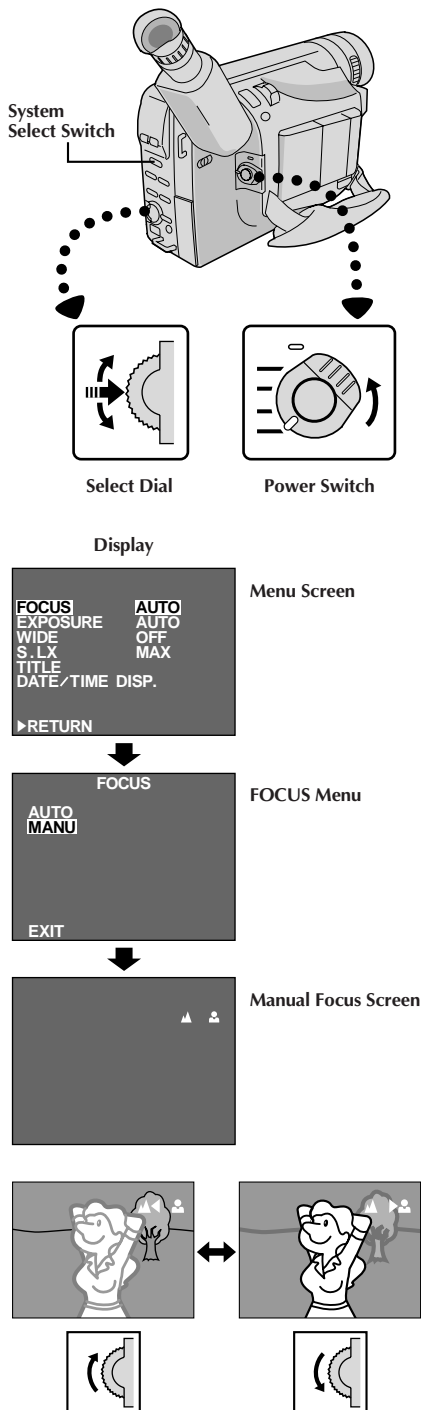

MANUAL FOCUS

NOTE:

You should already have made the necessary viewfinder adjustments (☞ pg. 14). If you haven't, do so before continuing.

- 1 SELECT OPERATION SYSTEM AND MODE**
Set the System Select Switch to "D.S.C." or "VIDEO", and set the Power Switch to "PRO."
- 2 ACCESS MENU SCREEN**
Press the Select Dial to display the Menu Screen.
- 3 ACCESS "FOCUS" MENU**
Move the highlight bar to "FOCUS" by rotating the Select Dial, then press it.
- 4 ACCESS MANUAL FOCUS**
Rotate the Select Dial to move the highlight bar to "MANU", then press it. "▲" and "●" appear. The focus is locked at this point.
- 5 ADJUST FOCUS**
To farther subject . . .
.... rotate the Select Dial upward. "◀" appears and blinks.
Go to step 6.
To nearer subject . . .
.... rotate the Select Dial downward. "▶" appears and blinks.
Go to step 6.
- 6 END ADJUSTMENT OF FOCUS**
Press the Select Dial. The Menu Screen reappears with the highlight bar on "RETURN".
- 7 CLOSE MENU SCREEN**
Press the Select Dial. The Menu Screen disappears and "▲●" reappears to indicate the focus is locked.

NOTES:

- To return to Auto Focus, select "AUTO" in step 4.
- To re-adjust Manual Focus, repeat the procedure from step 2.
- Be sure to focus the lens in the maximum telephoto position when you use the Manual Focus mode. If you focus in on a certain subject in the wide-angle position, sharply focused images cannot be obtained when zoomed in because the depth-of-field is reduced at longer focal lengths.
- When the focus level cannot be adjusted any farther or closer, "▲" or "●" will blink.

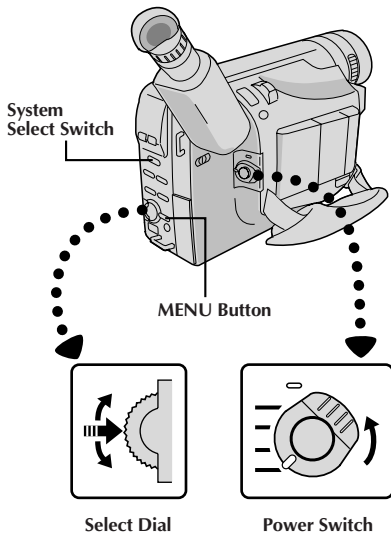

Display

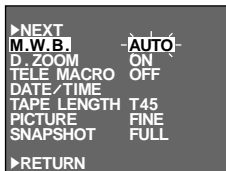

Menu Screen

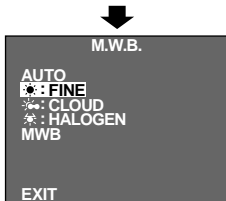

M.W.B. Menu

White Balance Adjustment

A term that refers to the correctness of colour reproduction under various lighting. If the white balance is correct, all other colours will be accurately reproduced. The white balance is usually adjusted automatically. However, the more advanced camcorder operator would prefer to control this function manually and achieve a more professional colour/tint reproduction.

1 SYSTEM OPERATION SYSTEM AND MODE

Set the System Select Switch to "D.S.C." or "VIDEO", and set the Power Switch to "PRO."

2 ACCESS MENU SCREEN

Press MENU. The Menu Screen appears.

3 ACCESS WHITE BALANCE ADJUSTMENT

Move the highlight bar to "M.W.B." by rotating the Select Dial, then press it. The Menu Screen disappears and the M.W.B. Menu appears.

4 SET FUNCTION PARAMETERS

Move the highlight bar to the required white balance by rotating the Select Dial.

"AUTO"

The white balance is adjusted automatically. This is the factory preset position.

"☀️ : FINE"

When shooting outdoors on a sunny day.

"☁️ : CLOUD"

When shooting outdoors on a cloudy day.

"💡 : HALOGEN"

When using a video light or other similar type of lighting.

"MWB"

When shooting with the white balance already having been set on the subject (to set "MWB", see pg. 41).

5 CLOSE MENU SCREEN

Press the Select Dial. The Menu Screen reappears with the highlight bar on "RETURN". Press the Select Dial again to close the Menu Screen.

To Return To Automatic White Balance . . .

.... select "AUTO" in step 4. Or set the Power Switch to "AUTO".

NOTE:

White balance cannot be used when Sepia (see pg. 31) is activated.

Manual White Balance Operation

If the camera is operating in PRO. mode, perform a Manual White Balance when shooting under various types of lighting.

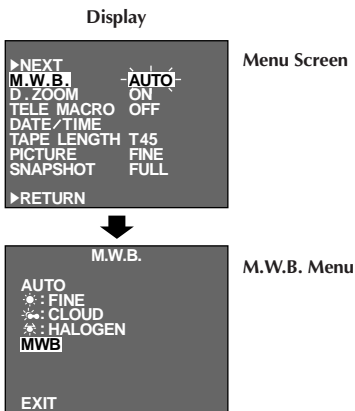
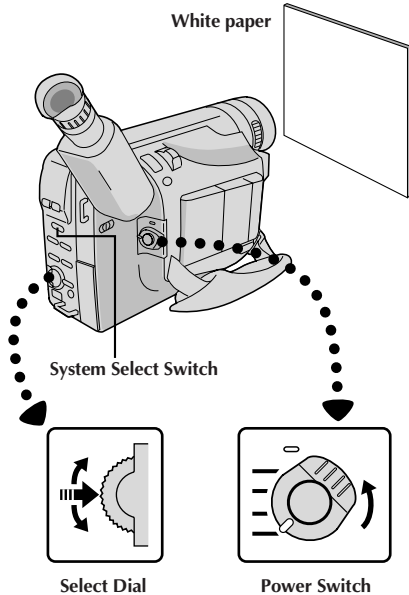

1 SELECT OPERATION SYSTEM AND MODE

Follow steps 1 through 4 of the white balance adjustment (☞ pg. 40), and select "MWB".

2 SET MANUAL WHITE BALANCE

Hold a sheet of plain white paper in front of the subject. Adjust zoom or position yourself so that the white paper fills the screen.

3 ENTER SETTING

Press the Select Dial until "MWB" begins blinking.

- When the setting is completed, "MWB" stops blinking, and the Menu Screen reappears with the highlight bar on "RETURN".

4 CLOSE MENU SCREEN

Press the Select Dial again to close the Menu Screen.

To Change The Tint For Recording . . .

.... in step 2, substitute coloured paper for white. The white balance is adjusted based on the colour, changing the tint. Red paper — deeper green; blue paper — orange; yellow paper — deeper purple.

NOTES:

- In step 2, it may be difficult to focus on the white paper in some circumstances. In such a case, adjust focus manually (☞ pg. 39).
- A subject can be shot under various types of lighting conditions indoors (natural, fluorescent, candlelight, etc.). Because the colour temperature is different depending on the light source, the tint of the subject will differ depending on the white balance settings. Use this function for a more natural result.
- Once you adjust white balance during Manual White Balance operation, the setting is retained even if the power is turned off or the battery removed.

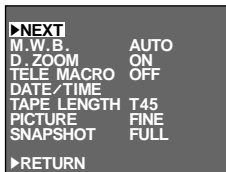
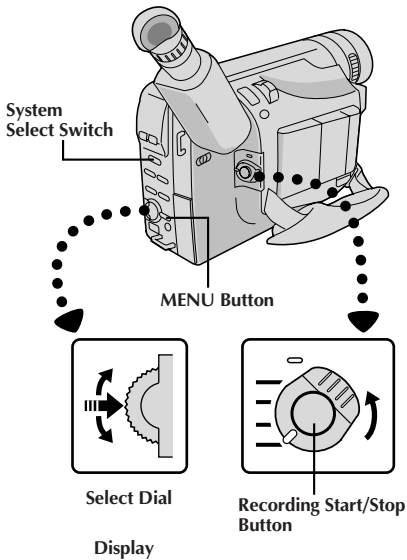

Menu Screen 1



Menu Screen 2

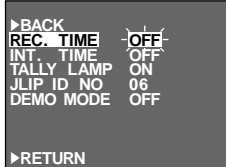

INT. TIME Menu

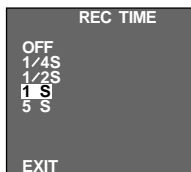

REC TIME Menu

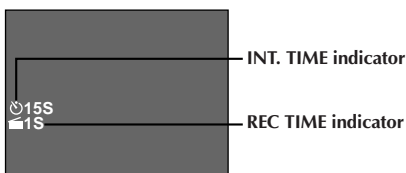

INT. TIME and REC TIME indications on the normal screen

Self-Timer

You can set the delay between pressing the Recording Start/Stop button and the actual start of recording. If you secure the camcorder, you (or whoever is operating the camcorder) can enter the scene before recording starts.

NOTE:

Before performing the following steps, make sure that:

- The System Select Switch is set to "VIDEO" or "D.S.C." according to your needs.
- The Power Switch is set to "PRO."
- The camcorder is in the Record-Standby mode.

1 ACCESS MENU SCREEN

Press MENU.

2 ACCESS "INT. TIME" MENU

Rotate the Select Dial to move the highlight bar to "NEXT" in Menu Screen 1 and press it to display Menu Screen 2. Then, move the highlight bar to "INT. TIME" and press it.

3 SET INTERVAL TIME

Rotate the Select Dial to move the highlight bar to the desired time, then press it. The Menu Screen reappears with the highlight bar on "RETURN".

4 CLOSE MENU SCREEN

Press the Select Dial.

5 START DELAYED RECORDING

If you set the System Select Switch to "VIDEO" . . .
 press the Recording Start/Stop Button. When the selected time has elapsed, recording begins automatically.

If you set the System Select Switch to "D.S.C." . . .
 press **SNAPSHOT**. When the selected time has elapsed, a still image is shot automatically.

To Cancel Self-Timer . . .

If you set the System Select Switch to "VIDEO" . . .

.... before the recording begins, press the Recording Start/Stop Button to display "≡PAUSE≡", then set "INT. TIME" in the Menu Screen to "OFF".

If you set the System Select Switch to "D.S.C." . . .

.... before shooting a still image, press **SNAPSHOT**, then set "INT.TIME" in the Menu Screen to "OFF".

Animation

You can give stationary scenes or objects an illusion of movement. This function allows you to shoot a series of pictures, each slightly different, of the same object for a brief period of time.

NOTE:

Before performing the following steps, make sure that:

- The System Select Switch is set to "VIDEO".
- The Power Switch is set to "PRO.".
- The camcorder is in the Record-Standby mode.
- The recording mode is set to "SP".

1 ACCESS MENU SCREEN

Press MENU.

2 SET RECORDING TIME

Rotate the Select Dial to move the highlight bar to "NEXT" in Menu Screen 1 and press it to display Menu Screen 2. Then, move the highlight bar to "REC TIME" and press it. The REC TIME Menu appears. Rotate the Select Dial to move the highlight bar to the desired time, then press it. The Menu Screen reappears with the highlight bar on "RETURN". Press the Select Dial again to close the Menu Screen.

3 START RECORDING

Press the Recording Start/Stop Button after focusing on the subject. The recording stops automatically after the selected period of time.

4 ASSEMBLE SERIES OF PICTURES

Repeat step 3 for the desired number of pictures.

5 RELEASE ANIMATION MODE

Set "REC TIME" in the Menu screen to "OFF".

NOTES:

- For best results, make sure the camcorder is secured when shooting in Animation or Time-Lapse mode.
- Fade- or wipe-in/out cannot be performed during Animation or Time-Lapse shooting.
- Before performing other operations following Animation or Time-Lapse recording, make sure the Animation or Time-Lapse mode is deactivated.
- Self-Timer, Animation and Time-Lapse are canceled when the power is shut off or when the cassette is ejected.

Time-Lapse

You can record sequentially at preset time spans. Leaving the camcorder aimed at a specific subject, you can record subtle changes over an extended period of time.

NOTE:

Before performing the following steps, make sure that:

- The System Select Switch is set to "VIDEO".
- The Power Switch is set to "PRO.".
- The camcorder is in the Record-Standby mode.
- The recording mode is set to "SP".

1 ACCESS MENU SCREEN

Press MENU.

2 SET INTERVAL BETWEEN RECORDINGS

Rotate the Select Dial to move the highlight bar to "NEXT" in Menu Screen 1 and press it to display Menu Screen 2. Then, move the highlight bar to "INT. TIME" and press it. The INT. TIME Menu appears. Rotate the Select Dial to move the highlight bar to the desired time, then press it. The Menu Screen reappears.

3 SET RECORDING TIME

Rotate the Select Dial to move the highlight bar to "REC TIME", then press it. The REC TIME Menu appears. Rotate the Select Dial to move the highlight bar to the desired time, then press it. The Menu Screen reappears with the highlight bar on "RETURN". Press the Select Dial again to close the Menu Screen.

4 START TIME-LAPSE RECORDING

Press the Recording Start/Stop Button. Recording and intervals alternate automatically.

5 RELEASE TIME-LAPSE MODE

To release when "≡PAUSE≡" is displayed, set "REC TIME" and "INT. TIME" in the Menu Screen to "OFF". To release when "≡PAUSE≡" and "▶▶▶" are not displayed, press the Recording Start/Stop Button to display "≡PAUSE≡", then set "REC TIME" and "INT. TIME" in the Menu Screen to "OFF".

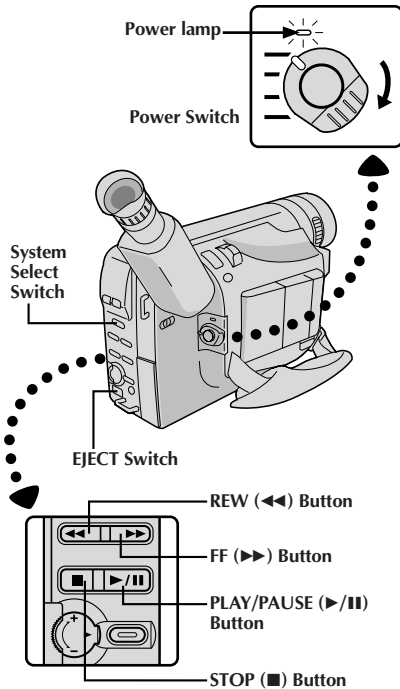

LCD Monitor in Retracted Position

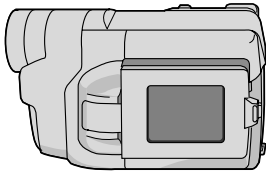

Battery pack remaining power indicator

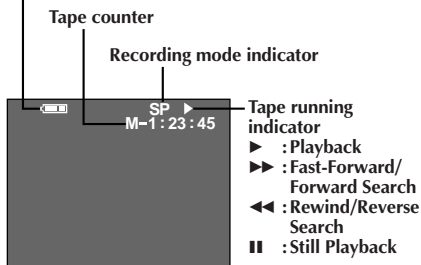

LCD monitor/viewfinder indications

1 LOAD A CASSETTE

First open the LCD monitor to an angle of over 60 degrees. Slide **EJECT** to open the cassette holder, then insert the cassette with the label facing out. Press **PUSH** to ensure the holder is closed and locked.

2 SELECT OPERATION SYSTEM AND MODE

Make sure the LCD monitor is fully open. Set the System Select Switch to "VIDEO", and set the Power Switch to "PLAY".

3 PLAY BACK

Press **PLAY/PAUSE** (▶/||). The playback picture appears.

4 STOP PLAYBACK

Press **STOP** (■).

Rewind or Fast-Forward the tape

Press **REW** (◀◀) to rewind, or **FF** (▶▶) to fast-forward the tape during Stop mode.

NOTES:

- The camcorder shuts off automatically after about 5 minutes in Stop mode. To turn on again, set the Power Switch to "POWER OFF", then to "PLAY".
- When the Power Switch is set to "PLAY" and the LCD monitor is opened at an angle of 60 degrees or more, the LCD monitor switches on and the viewfinder switches off automatically to save power.
- The playback picture can also be viewed in the viewfinder (with the LCD monitor shut) or on a connected TV (see pg. 48, 49). Camcorder operation is the same as described in this section.
- You can also view the playback picture on the LCD monitor with it flipped over and retracted.
- If a blank portion on the tape is played back, the screen may become black. This is not a malfunction.

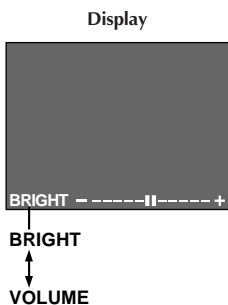
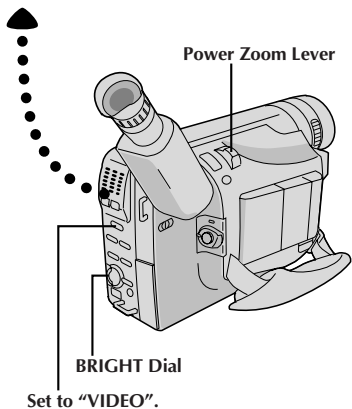
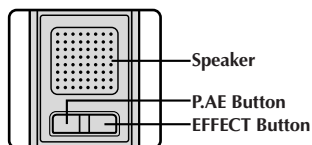

Adjust the brightness of the LCD monitor

To brighten the image, turn the **BRIGHT** Dial towards "+".
To darken the image, turn the Dial towards "-".

Speaker Volume Control

You can adjust the speaker volume by pushing the Power Zoom Lever.

1 ADJUST VOLUME

If you want to turn up the volume . . .

.... push the Power Zoom Lever towards "T".

If you want to turn down the volume . . .

.... push the Power Zoom Lever towards "W".

Tracking

This function can be used to eliminate noise bars that appear on-screen during playback. Initial setting is Auto Tracking. Manual Tracking is also available.

1 ACTIVATE MANUAL TRACKING

Press **P.A.E** and **EFFECT** simultaneously. Then, press **P.A.E** or **EFFECT** as many times as necessary until the noise bars disappear.

- To return to Auto Tracking, press **P.A.E** and **EFFECT** simultaneously. "AT" blinks. When Auto Tracking finishes, the indication disappears.

NOTES:

- When noise bars appear during playback, the camcorder enters the Auto Tracking mode and "AT" is displayed.
- Manual Tracking may not work with tapes recorded on other VCRs or camcorders.

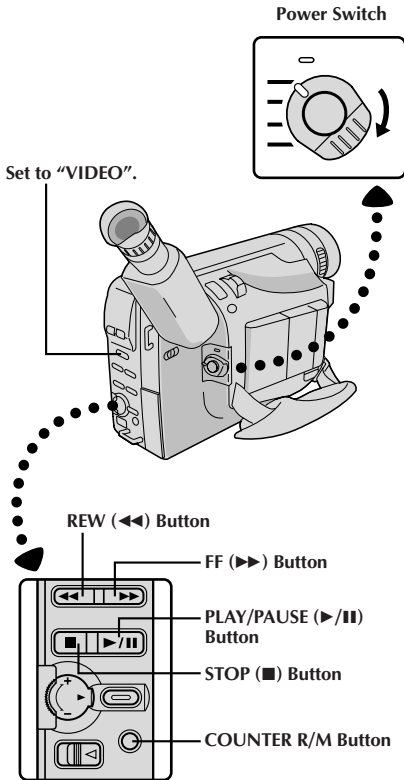

FEATURE: Still Playback

PURPOSE:

To pause during playback.

OPERATION:

- 1) Press **PLAY/PAUSE** (▶/⏸) during playback.
- 2) To resume normal playback, press **PLAY/PAUSE** (▶/⏸) again.

NOTE:

Noise bars appear and pictures may become monochrome during Still Playback. This is normal.

FEATURE: Shuttle Search

PURPOSE:

To allow high-speed search in either direction.

OPERATION:

- 1) Press **FF** (▶▶) to search forward or press **REW** (◀◀) to reverse during playback.
- 2) To resume normal playback, press **PLAY/PAUSE** (▶/⏸).

NOTES:

- During playback, press and hold **REW** (◀◀) or **FF** (▶▶). The search continues as long as you hold the button. Once you release it, normal playback resumes.
- Noise bars appear and pictures may become monochrome or darken during Shuttle Search. This is normal.

FEATURE: Counter Memory Function

PURPOSE:

To make it easier to locate a specific tape segment.

OPERATION:

- 1) Press **COUNTER R/M** and hold for more than 1 second. The counter resets to "0:00:00".
- 2) Press **COUNTER R/M** for less than 1 second. "M" appears.
- 3) After recording or playback, press **STOP** (■), then **REW** (◀◀). The tape automatically stops at or close to 0:00:00.
- 4) Press **PLAY/PAUSE** (▶/⏸) to start playback.

NOTES:

- The counter memory functions in the Fast-Forward and Rewind modes.
- To disable the Counter Memory Function, press **COUNTER R/M** for less than 1 second so that "M" disappears.

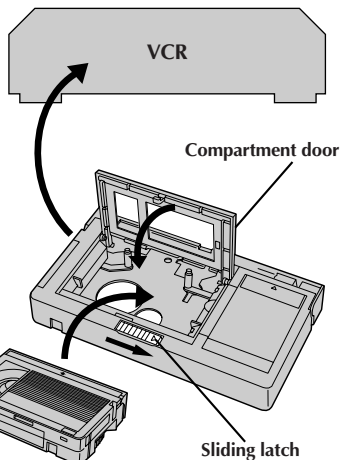
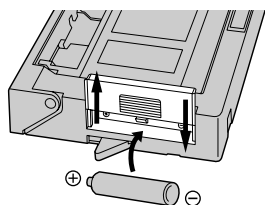

Compact video cassette

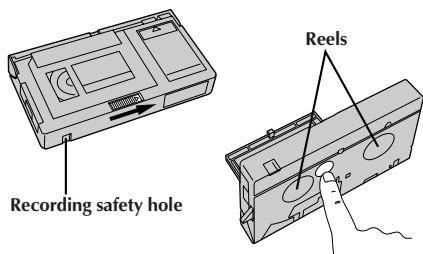

Cassette Adapter

Use this to play back a VHS-C video cassette recorded with this camcorder on a VHS VCR. It is fully compatible with any VHS video cassette recorder. The C-P7U adapter is battery powered and automatically performs tape loading and unloading.

1 INSERT BATTERY

Slide the battery cover up to remove it, and install one "R6 (AA)" size battery as shown in the illustration on left, then reattach the cover.

2 INSERT CASSETTE IN ADAPTER

Slide the latch to open the adapter compartment door, then insert the cassette and close the compartment door.

3 PLAY BACK ON CONNECTED VCR

Load the cassette adapter into the VCR and play the tape back as you would any other.

4 REMOVE CASSETTE FROM ADAPTER

Slide the latch and the compartment door opens automatically. This may take around 10 seconds. Do not attempt to force the adapter open. Then, insert your finger in the hole on the underside of the adapter as shown in the illustration on left, and push up and remove the cassette.

NOTES:

- During tape loading and unloading, do not touch the reels for safety and tape protection.
- During special-effect playback (slow motion, still frame, etc.), the picture may vibrate or noise bars may appear on the screen.
- To record on a VCR using a compact cassette and the adapter, cover the adapter's recording safety hole with adhesive tape.

These are some basic types of connections. When making connections, refer also to your VCR and TV instruction manuals.

Basic Connections

Use optional Video and Audio cables.

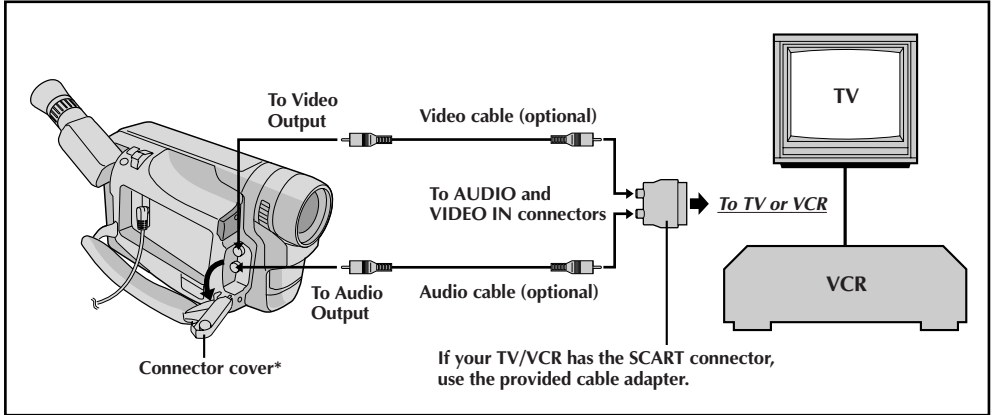

Connection For Tape Dubbing

Use optional Video and Audio cables.

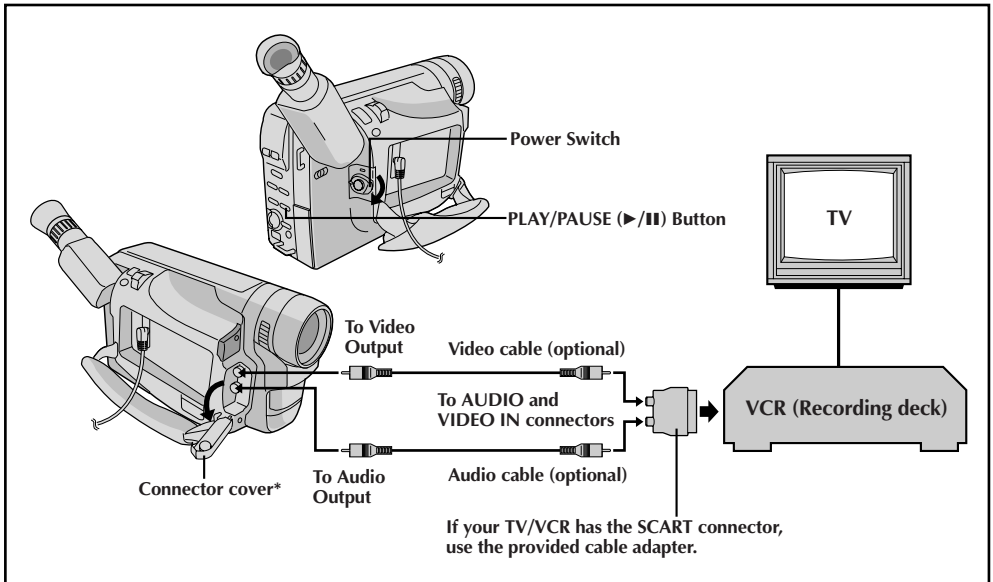

* When connecting the cables, open this cover.

Basic Connections

- 1 CONFIRM POWER-OFF STATUS**
Make sure the camcorder's power is off.
- 2 CONNECT CAMCORDER TO TV OR VCR**
Pull out the connector cover and open it.
Connect as shown in the illustration (☞ pg. 48).
If using a VCR . . . go to step 3.
If not . . . go to step 4.
- 3 CONNECT VCR OUTPUT TO TV INPUT**
Refer to your VCR's instruction manual.
- 4 SUPPLY POWER**
Turn on the camcorder, the VCR and the TV.
- 5 SELECT MODE**
Set the VCR to its AUX input mode, and set the TV to its VIDEO mode.

NOTES:

- *It is recommended to use the AC Power Adapter/Charger as the power supply instead of the battery pack (☞ pg. 9).*
- *To monitor the picture and sound from the camcorder without inserting a tape, set the camcorder's Power Switch to "CAMERA" ("AUTO" or "PRO."), then set your TV to the appropriate input mode.*
- *Make sure you adjust the TV sound volume to its minimum level to avoid a sudden burst of sound when the camcorder is turned on.*
- *If you have a TV or speakers that are not specially shielded, do not place the speakers adjacent to the TV as interference will occur in the camcorder playback picture.*

Tape Dubbing

- 1 CONNECT EQUIPMENT**
Following the illustration on pg. 48, connect the camcorder and the VCR.
- 2 PREPARE FOR DUBBING**
Set the camcorder's Power Switch to "PLAY", turn on the VCR's power, and insert the appropriate cassettes in the camcorder and the VCR.
- 3 SELECT VCR MODE**
Engage the VCR's AUX and Record-Pause modes.
- 4 FIND EDIT-IN POINT**
Engage the camcorder's Play mode to find a spot just before the edit-in point. Once it is reached, press **PLAY/PAUSE** (▶/||) on the camcorder.
- 5 START EDITING**
Press **PLAY/PAUSE** (▶/||) on the camcorder and engage the VCR's Record mode.
- 6 STOP EDITING TEMPORARILY**
Engage the VCR's Record-Pause mode and press **PLAY/PAUSE** (▶/||) on the camcorder.
- 7 EDIT MORE SEGMENTS**
Repeat steps 4 through 6 for additional editing, then stop the VCR and camcorder when finished.

NOTE:

If you wish to dub still images recorded with the System Select Switch set to "D.S.C.", play back the still images (☞ pg. 50 – 54) instead of doing the above steps 4 thorough 6, engage the VCR's Record mode and record them onto a tape.

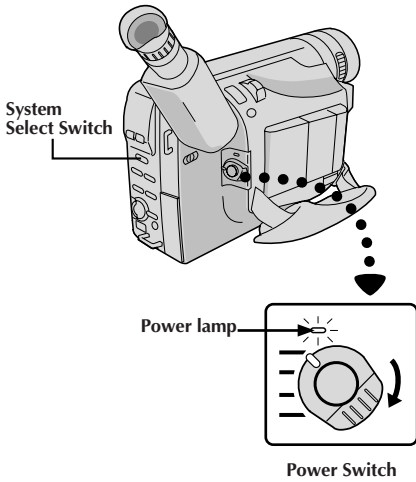

To move
the page next

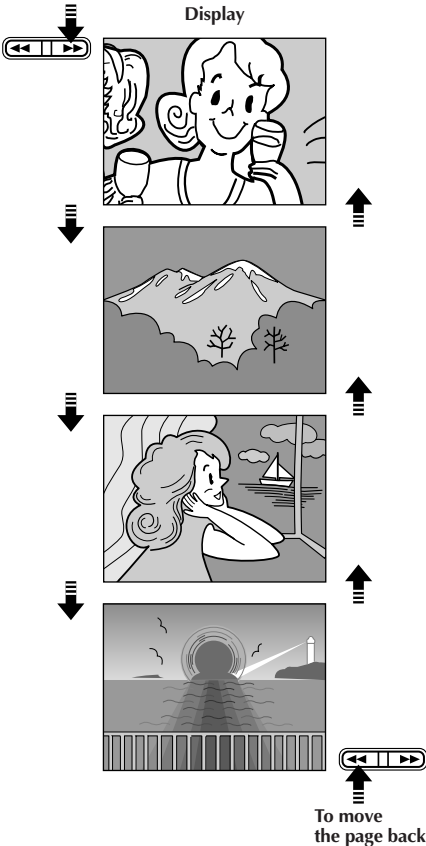

Still images shot using this camcorder are automatically numbered, then stored in numerical order in the built-in memory. You can view the still images stored in memory, one at a time, much like flipping through a photo album.

1 SELECT OPERATION SYSTEM AND MODE

Set the System Select Switch to "D.S.C.", and set the Power Switch to "PLAY".

- The power lamp lights.
- The still image stored in memory is displayed.
- When no still image is stored in memory, the screen becomes blue.

2 PLAY BACK

Press **FF** (▶▶/PAGE+) or **REW** (◀◀/PAGE-) to select the still image you want to view.

- Each time **REW** (◀◀/PAGE-) is pressed, the page goes back, while each time **FF** (▶▶/PAGE+) is pressed, the page goes next.
- Even if you shoot a new picture after playing back a still image with a low number, this will not overwrite the existing picture because new pictures are automatically stored after the still image most recently stored in memory.

NOTES:

- When the Power Switch is set to "PLAY" and the LCD monitor is opened at an angle of 60 degrees or more, the LCD monitor switches on and the viewfinder switches off automatically to save power.
- The playback picture can also be viewed in the viewfinder (with the LCD monitor shut) or on a connected TV (pg. 48, 49). Camcorder operation is the same as described in this section.
- When viewing a playback picture on a connected TV, it may jitter slightly.
- You can also view the playback picture on the LCD monitor with it flipped over and retracted.

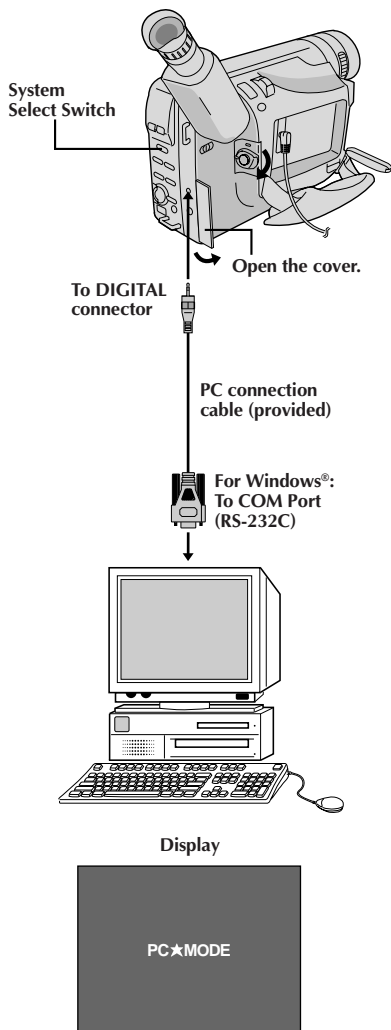

Connection to a Windows® PC

Image data stored in the camcorder's built-in memory can be transferred to a Windows® PC and saved using the provided image transfer software, Picture Navigator. The image data transferred to a Windows® PC can also be further processed using Mr. Photo Gold, and the still image processed on the PC can be inserted onto a tape (☞ pg. 65).

To assure safety, make sure all units are turned off before making any connection.

1 CONNECT TO PERSONAL COMPUTER

Connect the camcorder's DIGITAL connector to the COM Port (RS-232C) on a Windows® PC, using the provided PC connection cable.

2 SELECT OPERATION SYSTEM AND MODE

Set the System Select Switch to "D.S.C.", then set the Power Switch to "PLAY".

- A still image stored in memory appears.
- When transferring still images to a computer, be sure that a still image is displayed on the screen.

3 RUN IMAGE TRANSFER SOFTWARE

Launch the provided software on your Windows® PC. Transfer the still images stored in the camcorder's memory to the Windows® PC. Refer to the software's instruction manual on the provided CD-ROM for details.

- During transfer of the still image, the camcorder's screen becomes blue and "PC★MODE" is displayed. After transferring is finished, the screen displays the same still image as in step 2.

4 END TRANSFERRING

Close the software, then switch off the camcorder.

NOTES:

- Before transferring still images from your personal computer to the camcorder's built-in memory, perform the camcorder's Picture Mode Setting (☞ pg. 20). The still images will be transferred from the personal computer in the selected Picture Mode.
- When transferring still images from your personal computer to the camcorder, make sure the number of images to be transferred is smaller than the camcorder's remaining number of shots available.
- Use the AC Power Adapter/Charger as the power supply instead of the battery pack.
- The still images stored in the camcorder's memory are not automatically removed after being transferred to the PC. If you wish to remove those still images from the camcorder's memory, delete them (☞ pg. 56, 57).
- Windows® are trademarks of Microsoft Corporation, registered in the U.S.A. and other countries.

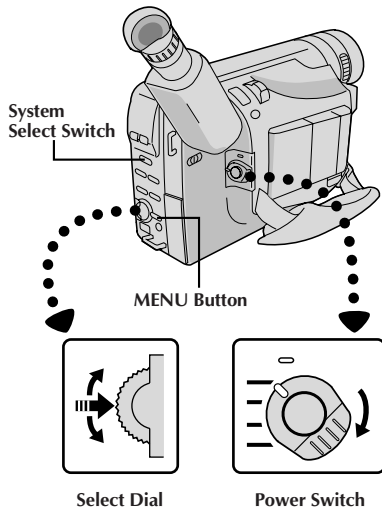

Display

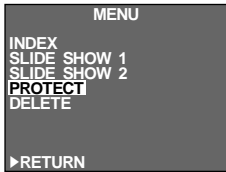

Menu Screen

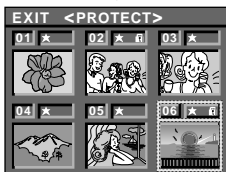
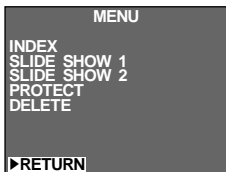
Setting Menu
(ex. PROTECT)

Normal Screen

Using Menu For Detailed Adjustment

This camcorder is equipped with an easy-to-use, on-screen menu system that simplifies many of the more detailed camcorder settings.

1 SELECT OPERATION SYSTEM AND MODE

Set the System Select Switch to "D.S.C.", and set the Power Switch to "PLAY".

2 ACCESS MENU SCREEN

Press MENU. The Menu Screen appears.

3 SELECT FUNCTION

Rotate the Select Dial to place the highlight bar on the desired function.

- If the setting you want cannot be found in the Menu Screen, place the highlight bar on "RETURN", then press the Select Dial.

4 MAKE SETTING



Press the Select Dial. The setting menu of the selected function appears. The setting procedure depends on the function you select.

If you select "SLIDE SHOW 1" or "SLIDE SHOW 2" . . .
 a slide-show will start (☞ pg. 53).

If you select any other functions . . .

.... see respective pages (INDEX: ☞ pg. 54,
 PROTECT: ☞ pg. 55, DELETE: ☞ pg. 56, 57)
 and do each procedure from step 4.

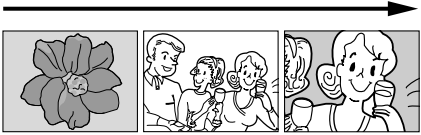
Menu Screen Explanations

Mode	Effect			
INDEX	All still images stored in memory can be displayed six at a time. This mode is a convenient way to look for the still image you want to view and to check the still images you shot beforehand (☞ pg. 54).			
SLIDE SHOW 1	<p>After doing steps 1 through 4 on pg. 52, you can run through all the still images stored in memory automatically in numerical order. Each still image is displayed. This mode is like a regular slide-show. If you wish to stop the slide-show, press the Select Dial twice.</p> 			
SLIDE SHOW 2	<p>After doing steps 1 through 4 on pg. 52, you can run through all the still images stored in memory automatically in numerical order. The still image wipes in over the last one from the bottom of the screen to the top. If you wish to stop the slide-show, press the Select Dial twice.</p> 			
PROTECT	Lets you protect selected still images from accidental erasure. Select a still image for which you want to perform "Protect" to put a padlock mark next to it. A still image with a padlock mark cannot be deleted. When selecting a still image to protect, you can check six still images stored in memory at a time (☞ pg. 55).			
DELETE	Allows you to delete some still images already stored in memory (☞ pg. 56).			
	<p>CAUTION: While "ENTER" is selected on the Delete Execute Menu and it is blinking, switching off the camcorder or removing the power supply unit (battery pack or AC Power Adapter/Charger) may cause the camcorder's built-in memory to become corrupt. Never remove the power supply unit at this stage.</p>			
	<table border="1"> <tr> <td data-bbox="273 1117 385 1174">SELECT</td> <td data-bbox="385 1117 1059 1174">Allows you to check 6 still images stored in memory at a time, to select the still images you want to delete.</td> </tr> <tr> <td data-bbox="273 1174 385 1233">ALL</td> <td data-bbox="385 1174 1059 1233">Allows you to delete all the still images at once except protected images.</td> </tr> </table>	SELECT	Allows you to check 6 still images stored in memory at a time, to select the still images you want to delete.	ALL
SELECT	Allows you to check 6 still images stored in memory at a time, to select the still images you want to delete.			
ALL	Allows you to delete all the still images at once except protected images.			

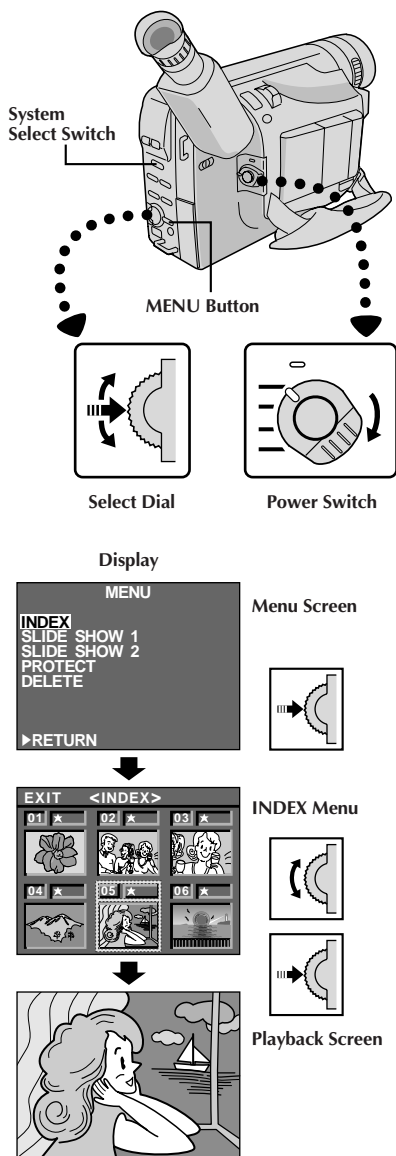

Index

You can view all still images stored in memory six at a time. Use this mode when looking for a still image you want to view and when checking the still images you shot beforehand.

1 SELECT OPERATION SYSTEM AND MODE

Set the System Select Switch to "D.S.C.", and set the Power Switch to "PLAY".

2 ACCESS MENU SCREEN

Press MENU. The Menu Screen appears.

3 ACCESS "INDEX" MENU

Rotate the Select Dial to move the highlight bar to "INDEX" and press it. The "INDEX" Menu appears.

4 VIEW INDEX IMAGES

Rotate the Select Dial to move the frame to the desired still image, then press it. The one you selected is displayed on the whole screen, then the screen enters normal playback.

- On the INDEX Menu, 6 still images are displayed at a time. When viewing the still images that follow the 6th one, rotate the Select Dial to move the frame from Index No. 1 to No. 6, and then rotate it further downward. The frame is placed on the 7th still image automatically. Images after the 7th one can also be accessed in the same way.
- If the desired still image cannot be found, place the highlight bar on "EXIT", then press the Select Dial twice to exit the Menu.

NOTES:

- When moving the frame from the 7th still image back to the 6th, rotate the Select Dial upward to place the highlight bar on "EXIT", then rotate it further upward. The frame is moved to the 6th still image. Perform the same procedure for the 13th image.
- On the INDEX Menu, a star mark is displayed next to a still image you shot in the FINE mode.

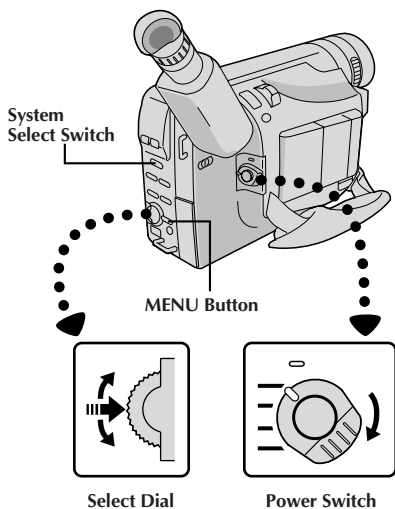

Display

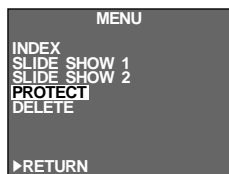

Menu Screen

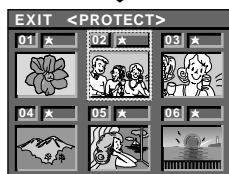

PROTECT Menu



A padlock mark appears.



Protect

This mode helps prevent accidental erasure of images. Put a padlock mark next to the desired still image, and that still image cannot be deleted.

1 SELECT OPERATION SYSTEM AND MODE

Set the System Select Switch to "D.S.C.", and set the Power Switch to "PLAY".

2 ACCESS MENU SCREEN

Press MENU. The Menu Screen appears.

3 ACCESS "PROTECT" MENU

Rotate the Select Dial to move the highlight bar to "PROTECT", and press it. The PROTECT Menu appears.

- If you do not want to perform "Protect" for any still image, go to step 5.

4 SET PROTECT

Rotate the Select Dial to move the frame to the desired still image, then press it. The padlock mark appears above the selected image.

- On the PROTECT Menu, all still images are displayed six at a time. To perform "Protect" for the still images that come after the 6th one, rotate the Select Dial to move the frame from Index No. 1 to No. 6, then rotate it further downward. The frame is placed automatically on the 7th still image. Images after the 7th one can also be accessed in the same way.
- To complete "Protect", go to step 5.

5 CLOSE MENU SCREEN

Rotate the Select Dial upward to place the highlight bar on "EXIT", then press it twice.

To remove "Protect" . . .

.... perform steps 1 through 3, rotate the Select Dial to move the frame to the desired still image with the padlock mark, then press it. The padlock mark located above the still image disappears and the image is no longer protected. When finished removing protection, perform step 5.

NOTES:

- To move the frame from Index No. 7 to 6, place the highlight bar on "EXIT" by rotating the Select Dial upward. Rotate the Select Dial further upward. The frame is moved to the 6th still image automatically. Perform the same procedure for still images that follow the 13th one.
- On the PROTECT Menu, a star mark is displayed next to a still image you shot in the FINE mode.

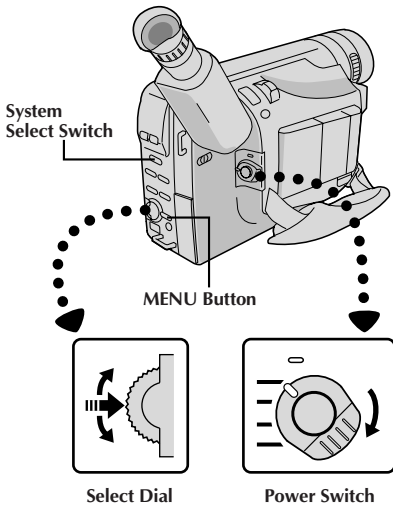

Display

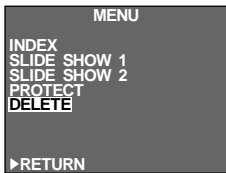

Menu Screen

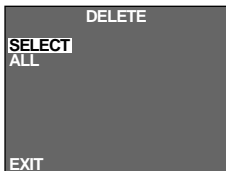

DELETE Menu

In case of "ALL"

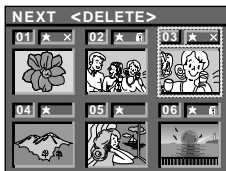

In case of "SELECT"

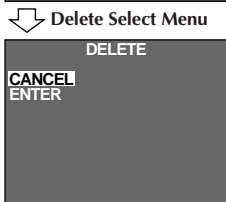

Delete Execute Menu

Menu Screen



Delete

When the memory in which still images are stored becomes full, the number of remaining shots available reaches "0" (blinking). In this situation it becomes impossible to take your next shot. Delete some still images already stored in memory to make room for new shots.

1 SELECT OPERATION SYSTEM AND MODE

Set the System Select Switch to "D.S.C.", and set the Power Switch to "PLAY".

2 ACCESS MENU SCREEN

Press MENU. The Menu Screen appears.

3 ACCESS "DELETE" MENU

Rotate the Select Dial to move the highlight bar to "DELETE", and press it. The DELETE Menu appears.

4 SELECT DELETE MODE

Rotate the Select Dial to move the highlight bar to "SELECT" or "ALL", then press it.

To select a still image by checking the still images stored in memory . . .

.... select "SELECT", then go to step 5.

To delete all the still images stored in memory at once without checking them . . .

.... select "ALL", then go to step 6.

To quit the Delete Mode . . .

.... rotate the Select Dial to place the highlight bar on "EXIT", then press it twice.

5 SELECT ON DELETE SELECT MENU

Rotate the Select Dial to move the frame to the desired still image, then press it. "X" appears above the selected still image. When you have finished selecting all the desired still images, rotate the Select Dial upward to place the highlight bar on "NEXT", then press the Select Dial.

- On the Delete Select Menu, the still images are displayed six at a time. To delete the still images that follow the 6th one, rotate the Select Dial to move the frame from No. 1 to No. 6, then rotate it further downward. The frame is moved to the 7th still image automatically. Perform the same procedure for still images that follow the 7th one.

In case of "SELECT"

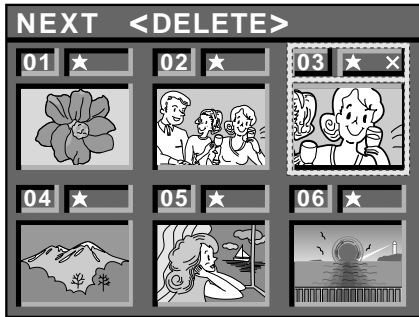

If you check the remaining still images on INDEX Menu after deleting...

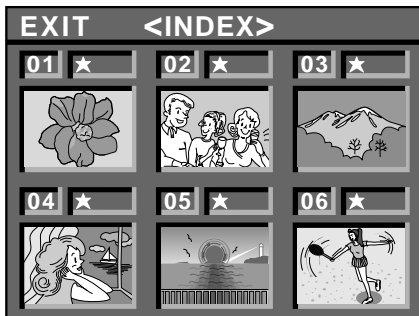

6 ACCESS DELETE EXECUTE MENU

Rotate the Select Dial to move the highlight bar to "CANCEL" or "ENTER", then press it.

- "CANCEL" does not delete the selected still images and the screen returns to the Menu Screen.
- "ENTER" deletes the selected still images. While "ENTER" blinks, they are in the process of being deleted from memory. After deleting is finished, the screen returns to the Menu Screen.

7 CLOSE MENU SCREEN

Press the Select Dial again to exit the Menu Screen.

CAUTION:

While "ENTER" is selected on the Delete Execute Menu and it is blinking, switching off the camcorder or removing the power supply unit (battery pack or AC Power Adapter/Charger) may cause the camcorder's built-in memory to become corrupt. **Never remove the power supply unit at this stage.**

NOTES:

- Before deleting some still images stored in memory, perform "Protect" for the necessary ones (☞ pg. 55) or save them on a PC so that you do not lose them accidentally (☞ pg. 51).
- Even if "ALL" is selected on the DELETE Menu, it is not possible to delete a still image with a padlock mark. "ALL" only deletes all still images that are not protected. After images are deleted from memory, the remaining images are automatically moved up to fill in any gaps in the numerical sequence. The Index No. for images protected (with the padlock mark) may therefore change.
- When selecting the desired still image in step 5, to move the frame from No. 7 to 6, place the highlight bar on "EXIT" by rotating the Select Dial upward. Rotate it further upward to move the frame to No. 6. Perform the same procedure for still images that follow the 13th one.
- On the Delete Select Menu, a star mark is displayed next to a still image you shot in the FINE mode.
- If the remaining number of shots is not 30 in the FINE mode or 60 in the STANDARD mode when "ALL" is selected on the DELETE Menu, initialize the camcorder's memory (☞ pg. 69).

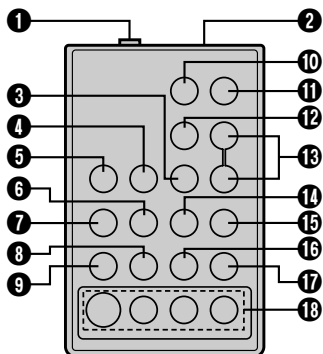
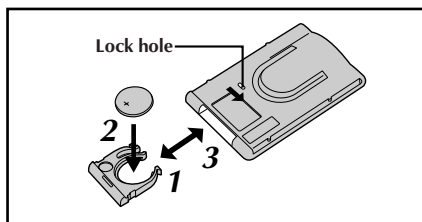

RM-V709U (provided)

The Full-Function Remote Control Unit can operate this camcorder from a distance as well as the basic operations (Playback, Stop, Pause, Fast-Forward and Rewind) of your VCR. The RM-V709U remote control unit makes additional recording functions possible.

Installing The Battery

The remote control uses one lithium battery (CR2025).

1

PULL OUT BATTERY HOLDER

Pull out the battery holder while sliding the lock hole.

2

INSERT BATTERY IN HOLDER

Insert the battery in the holder, and be sure to have the "+" mark visible.

3

RE-INSERT HOLDER

Slide the holder back in until you hear a click.

- Read the caution concerning lithium batteries (☞ pg. 2).

Buttons	Functions	
	With the camcorder's Power Switch set to "CAMERA" ("AUTO" or "PRO.").	With the camcorder's Power Switch set to "PLAY".
① PAUSE IN Connector	—	☞ pg. 61
② Infrared beam transmitting window	Transmits the beam signal.	
③ MBR SET Button	—	☞ pg. 60
④ INT. TIME Button	Self-Timer/Time-Lapse (☞ pg. 59)	—
⑤ REC TIME Button	Animation/Time-Lapse (☞ pg. 59)	—
⑥ FF Button	Retake (forward) (☞ pg. 27)	Fast-Forward, Forward Shuttle Search (☞ pg. 44, 46)
⑦ REW Button	Retake (rewind)/Quick Review (☞ pg. 27)	Rewind, Reverse Shuttle Search (☞ pg. 44, 46)
⑧ PAUSE Button	—	Pause (☞ pg. 46)
⑨ PLAY Button	—	Playback start (☞ pg. 44)
⑩ SNAPSHOT Button	Functions same as snapshot button on the camcorder. (☞ pg. 20, 24)	—
⑪ START/STOP Button	Functions the same as the Recording Start/Stop Button on the camcorder.	
⑫ VISS Button	Ineffective	
⑬ ZOOM (T/W) Buttons	Zoom in and out (☞ pg. 26)	—
⑭ VCR CTL Button	—	☞ pg. 60
⑮ DUB Button	—	Audio dubbing (☞ pg. 66)
⑯ STOP Button	—	Stop (☞ pg. 44)
⑰ INSERT Button	—	Insert Editing (☞ pg. 64, 65)
⑱ R.A.EDIT Buttons	—	☞ pg. 62

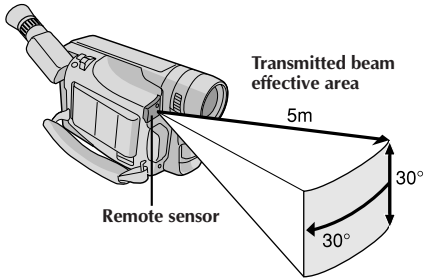

When using the remote control, be sure to point it at the remote sensor. The illustration shows the approximate transmitted beam effective area for indoor use.

The transmitted beam may not be effective or may cause incorrect operation outdoors or when the remote sensor is directly exposed to sunlight or powerful lighting.

Interval timer indicator

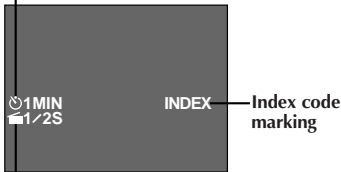

Rec time indicator

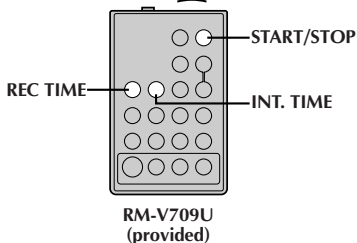
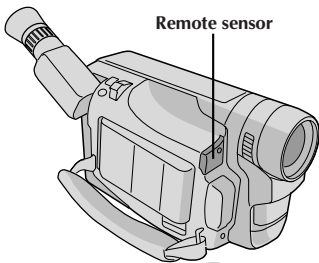

FEATURE: Self-Timer, Animation and Time-Lapse

PURPOSE:

The remote control lets you set/release Interval Timer and Rec Time functions without using the Menu Screen.

OPERATION:

Self-Timer

1) Set

Instead of performing steps 1 through 4 on pg. 42 ("Self-Timer"), press **INT. TIME** on the remote control. Each time **INT. TIME** is pressed, the Interval Timer indicator appears, changing in the following order: 15S, 30S, 1MIN, 5MIN and No indication (off).

2) Release

Instead of setting "INT. TIME" to "OFF" in the Menu, press **INT. TIME** on the remote control until the Interval Timer indicator disappears.

Animation

1) Set

Instead of performing steps 1 and 2 on pg. 43 ("Animation"), press **REC TIME** on the remote control. Each time **REC TIME** is pressed, the Rec Time indicator appears, changing in the following order: 1/4S, 1/2S, 1S, 5S and No indication (off).

2) Release

Instead of using the Menu in step 5 on pg. 43, press **REC TIME** on the remote control until the Rec Time indicator disappears.

Time-Lapse

1) Set

Instead of performing steps 1 through 3 on pg. 43 ("Time-Lapse"), press **INT. TIME** and **REC TIME** on the remote control. Each time **INT. TIME** is pressed, the Interval Timer indicator appears, changing in the following order: 15S, 30S, 1MIN, 5MIN and No indication (off). Each time **REC TIME** is pressed, the Rec Time indicator appears, changing in the following order: 1/4S, 1/2S, 1S, 5S and No indication (off).

2) Release

Instead of using the Menu in step 5 on pg. 43, press **INT. TIME** and **REC TIME** on the remote control until the indicators disappear.

NOTE:

Also refer to pgs. 42 and 43.

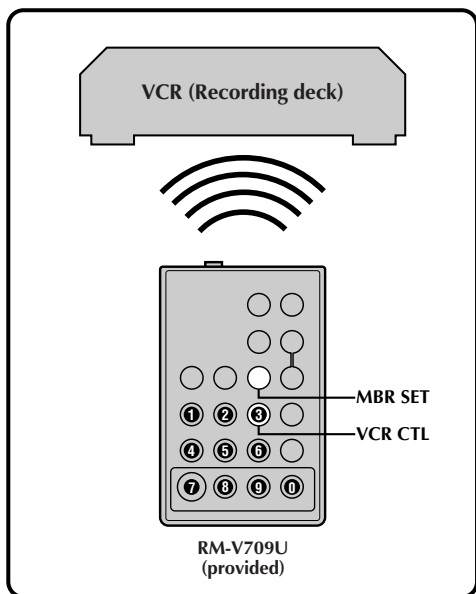

Random Assemble Editing [R.A.Edit]

Create edited videos easily using your camcorder as the source player. You can select up to 8 "cuts" for automatic editing, in any order you like. R.A.Edit is more easily performed when the RM-V709U MBR (Multi-Brand Remote, see pg. 58) is set to operate with your brand of VCR (see VCR CODE LIST), but can also be performed by operating the VCR manually.

Before operation, make sure the lithium battery is installed in the remote control RM-V709U (see pg. 58).

SET REMOTE/VCR CODE

1 SET REMOTE TO OPERATE VCR

Turn off the power to the VCR and point the remote towards the VCR's infrared sensor. Then, referring to the VCR CODE LIST on the left, press and hold **MBR SET**, and press button (A) and then (B).

- The code is automatically set once you release **MBR SET**, and the VCR's power comes on.

2 OPERATE VCR

Make sure the VCR's power is on. Then, while holding **VCR CTL**, press the button on the remote for the desired function. The functions the remote can control are PLAY, STOP, PAUSE, FF, REW and VCR REC STBY (you do not need to press **VCR CTL** for this one).

You are now ready to try Random Assemble Editing.

IMPORTANT

Although the MBR is compatible with JVC VCRs and those of many other makers, it may not work with yours or may offer limited functions.

NOTES:

- If the VCR's power does not come on in step 1, try another code from the VCR CODE LIST.
- Some brands of VCR do not come on automatically. In this case, turn the power on manually and try step 2.
- If the remote control is not able to control the VCR, use the controls on the VCR.
- When the remote control's battery runs out, the VCR brand you have set will be erased. In that case, replace the old battery with a new one and reset the VCR brand.

VCR CODE LIST

VCR BRAND NAME	BUTTONS (A) (B)	VCR BRAND NAME	BUTTONS (A) (B)
AKAI	6 2 6 4 7 7	PHILIPS	1 9 9 5 1 1 9 4 9 1
BLAUPUNKT	1 3		9 6 1 2 3 3 7 2
FERGUSON	9 7 9 8 3 2	SANYO	3 6 3 5
GRUNDIG	1 4 3 4	SELECO, REX	9 1 9 6
HITACHI	6 6 6 3	SHARP	1 5 1 0
JVC A B C	9 1 9 6 9 3	SONY	6 5 6 0 3 9 3 1
MITSUBISHI	6 7 6 8	THOMSON, TELEFUNKEN, SABA, NORDMENDE	9 1 9 6 9 7 3 2
NEC	3 7 3 8	TOSHIBA	6 9 6 1
PANASONIC	1 3 1 7 1 1 9 4 1 8		

MAKE CONNECTIONS

1 CONNECT TO . . .**A JVC VCR EQUIPPED WITH REMOTE PAUSE TERMINAL**

Connect the editing cable to the Remote PAUSE terminal.

B JVC VCR NOT EQUIPPED WITH REMOTE PAUSE TERMINAL BUT EQUIPPED WITH R.A. EDIT CONNECTOR

Connect the editing cable to the R.A.EDIT connector.

C VCR OTHER THAN TYPE A OR B

Connect the editing cable to the RM-V709U's PAUSE-IN connector.

2 PREPARE CAMCORDER

Insert a recorded tape. Set the System Select Switch to "VIDEO", and set the Power Switch to "PLAY".

3 PREPARE VCR

Turn the power on, insert a recordable tape and engage the AUX mode (refer to the VCR's instructions).

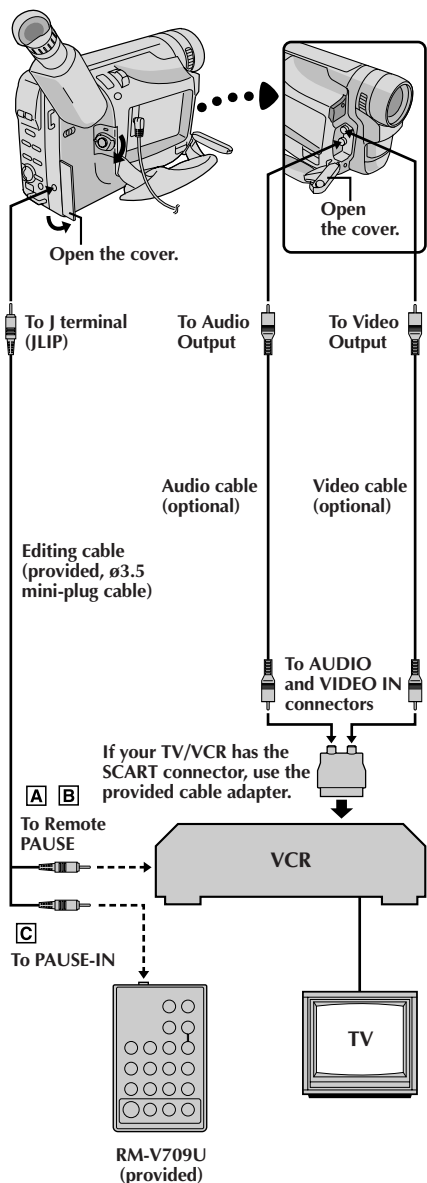

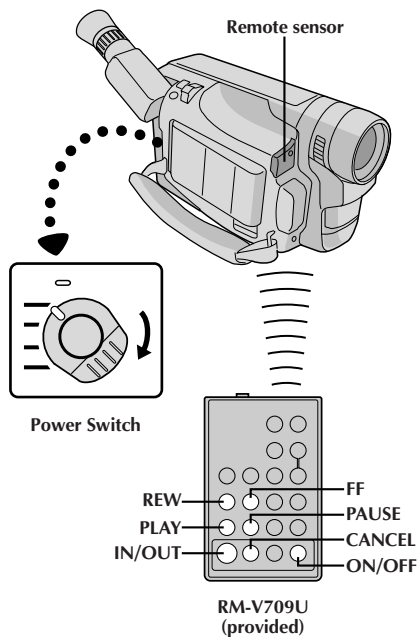

	IN	OUT
1	0:00:25	--:--:--
2		
3		
4		
5		
6		
7		
8		
COUNTER	0:00:25	
TOTAL	0:00:00	

	IN	OUT
1	0:00:25	0:01:05
2	0:03:18	0:03:31
3	0:02:33	0:02:53
4	0:04:11	--:--:--
5		
6		
7		
8		
COUNTER	0:04:11	
TOTAL	0:01:13	

SELECT SCENES

4 START SOURCE PLAYBACK

Press **PLAY**, then press **ON/OFF** on the remote control. Make sure to point the remote control at the camcorder's remote sensor.

- The R.A. Edit counter display appears.

5 REGISTER BEGINNING OF SCENE

Press **REW** or **FF** to locate the beginning of the scene you want, then press **IN/OUT** to register that point.

- The data appears under "IN" on the display.

6 REGISTER END OF SCENE

Press **REW** or **FF** to locate the end of the scene and press **IN/OUT** to register it.

- The data appears under "OUT" on the display.
- The total time of the registered scene(s) is displayed at the bottom of the screen.

7 REGISTER ADDITIONAL SCENES

Repeat steps 5 and 6 for each additional scene (as many as 8).

8 MAKE CORRECTIONS (IF NECESSARY)

Press **CANCEL** during steps 5 and 6 to erase the most recently registered point.

NOTES:

- There must be at least one second between an in-point and its corresponding out-point.
- To ensure correct operation, there should be at least 15 seconds between an out-point and the next in-point.
- Blank portions of a tape cannot be registered as in-points or out-points.
- If it takes more than 5 minutes to search for an in-point, the VCR's Record-Pause mode is cancelled and editing does not take place.
- Pressing **ON/OFF** clears all in- and out-points from memory.
- Leave a small margin for error around each in-point to ensure the scene is recorded in its entirety.
- Turning off the camcorder's power erases all registered in- and out-points.

AUTOMATIC EDITING TO VCR

9 PREPARE SOURCE TAPE

Rewind the tape in the camcorder to the beginning of the scene you want to edit and press **PAUSE**.

10 ENGAGE VCR'S RECORD-PAUSE MODE

Point the remote control towards the VCR's infrared sensor and press **VCR REC STBY**, or manually engage the VCR's Record-Pause mode.

11 BEGIN AUTOMATIC EDITING

Press **MENU/DISPLAY** on the camcorder, and the previously selected scenes are copied to the VCR in the specified order.

While editing, the R.A. Edit counter of the scene which is being copied is shown with a blinking highlight.

- Pressing **START/STOP** on the remote control does not start editing.

12 END AUTOMATIC EDITING

When all selected scenes have been copied, the camcorder and VCR enter the Still or Pause mode. Press **STOP** on both units. To make the R.A. Edit counter display disappear, press **ON/OFF**.

- When finished editing, be sure to disconnect the editing cable and the audio/video cable.

NOTES:

- If you performed step 1  on page 61 ("MAKE CONNECTIONS"), keep the remote control pointed at the VCR during editing.
- The on-screen display only appears while the camcorder searches for each scene.
- There may be noise at in- or out-points on the edited tape with certain VCRs.

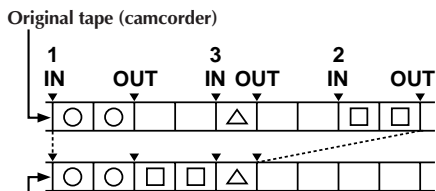

Edited tape (VCR)

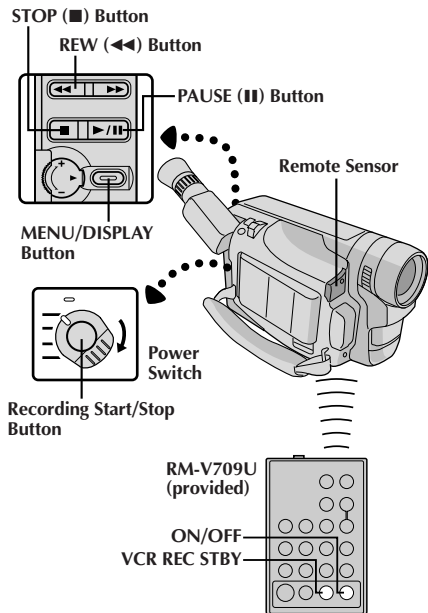
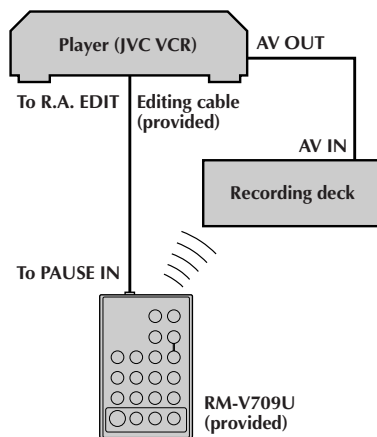
**SUPPLEMENTAL INFORMATION ON THE REMOTE CONTROL**

Using the RM-V709U, it is also possible to perform deck-to-deck Random Assemble Editing. The playback deck must be an R.A. Edit-capable JVC VCR. The recording deck can be...

- a VCR other than JVC, or
- a JVC VCR which has **neither** a Remote PAUSE nor an R.A. EDIT connector

How to use:

- Connect the playback deck and RM-V709U as shown on the left.
- Set the RM-V709U to correspond to the brand of the recording deck. (☞ pg. 60)
- For Random Assemble Editing procedure, please refer to the instruction manual of the JVC VCR you are using as the playback deck.

Notes:

- RM-V709U cannot be used to control the playback deck.
- RM-V709U is capable of controlling basic operations of the recording deck. While pressing VCR CTL, press PLAY, STOP, PAUSE, FF or REW for these functions. (Not possible with some brands and models.) Other buttons cannot be used.
- To put the recording deck in the Record-Pause mode, use the controls on the recording deck itself.

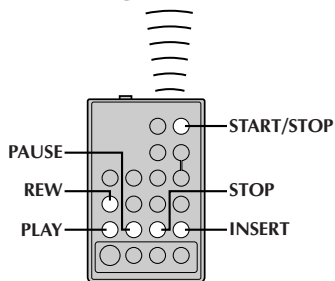
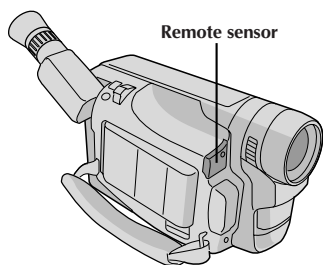
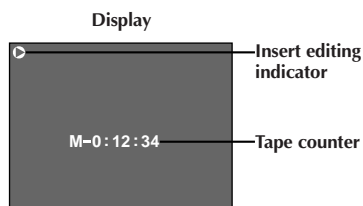
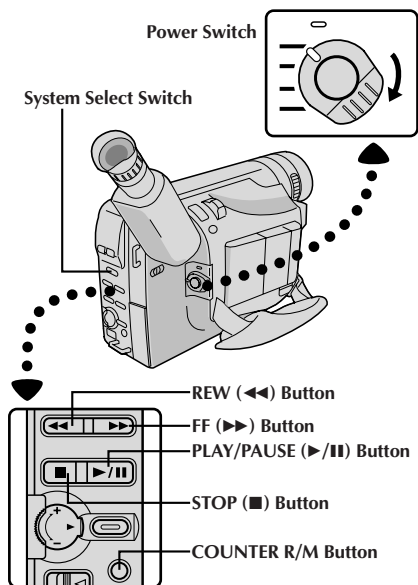
RM-V709U
(provided)

Insert Editing (VIDEO)

You can record a new scene onto a previously recorded tape, replacing a section of the original recording with minimal picture distortion at the in- and out-points. The original audio remains unchanged.

NOTE:

Use the RM-V709U remote control unit to perform this procedure.

1 SELECT OPERATION SYSTEM AND MODE

Set the System Select Switch to "VIDEO", and set the Power Switch to "PLAY".

2 FIND EDIT-OUT POINT

Play back the tape, locate the Edit Out point and press **PAUSE** on the camcorder or the remote control.

3 RESET COUNTER

Press and hold **COUNTER R/M** for more than 1 second to reset the tape counter, then press again for less than 1 second so that "M" appears.

4 FIND EDIT-IN POINT

Press **REW** to go a little beyond the beginning of the scene you want to replace, press **PLAY** to view the recorded tape, and press **PAUSE** exactly at the Edit-In point where the new scene should start.

5 ENGAGE INSERT EDITING MODE

Press and hold **INSERT**, and without releasing **INSERT**, press and release **PAUSE**. The Insert Editing mode is engaged. When the scene the camcorder is aimed at appears on the screen, go to the next step.

6 BEGIN INSERT EDITING

Press **START/STOP**. When the counter reaches "0:00:00", editing stops automatically and the camcorder enters the Insert-Pause mode.

7 END INSERT EDITING

Press **STOP**.

NOTES:

- During Insert Editing, the original audio will be heard from the speaker.
- After step 5, Retake (☐ pg. 27) can be performed.
- The tape may stop slightly before or after the designated end point, and noise bars may appear. Neither indicates a defect in the unit.
- Only the video signal is recorded in the Insert Editing mode.

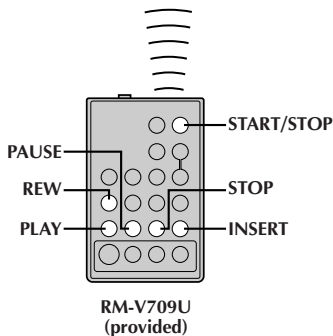
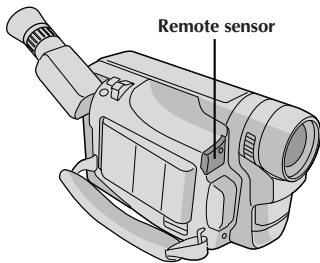
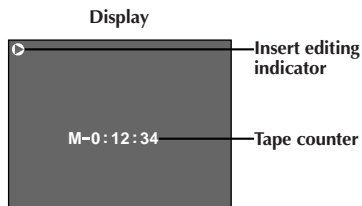
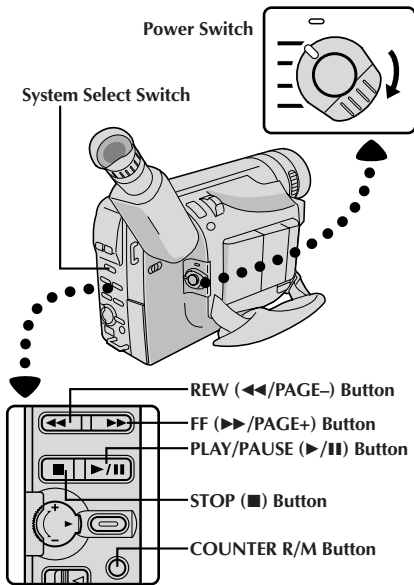

Insert Editing (Insert A Still Image From The Built-in Memory Onto A Tape)

You can insert a still image stored in the camcorder's built-in memory into a previously recorded tape, replacing a section of the original recording with minimal picture distortion at the in- and out-points. The original audio remains unchanged.

Perform steps 1 through 5 in Insert Editing (VIDEO) (pg. 64) before the following procedure.

NOTE:

Use the RM-V709U remote control unit to perform this procedure.

1 SELECT STILL IMAGE

First set the System Select Switch to "D.S.C.". Press **REW (◀/PAGE-)** or **FF (▶/PAGE+)** to select the still image you wish to insert.

2 BEGIN INSERT EDITING

Press **START/STOP**. When the counter reaches "0:00:00", editing stops automatically and the camcorder enters the Insert-Pause mode.

To insert still images in sequential order onto the tape . . .

... press **REW (◀/PAGE-)** or **FF (▶/PAGE+)** to move the page forward.

To insert still images at random onto the tape . . .

... first record the still image you selected in step 1 onto the tape, then press **START/STOP** to engage the Insert-Pause mode. To select another still image, press **REW (◀/PAGE-)** or **FF (▶/PAGE+)** again, then press **START/STOP**. Insert-Editing begins.

3 END INSERT EDITING

Press **STOP**.

NOTES:

- The tape may stop slightly before or after the designated end point, and noise bars may appear. Neither indicates a defect in the unit.
- Only video signal is recorded in the Insert Editing mode.

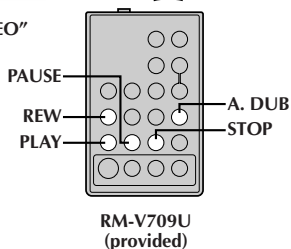
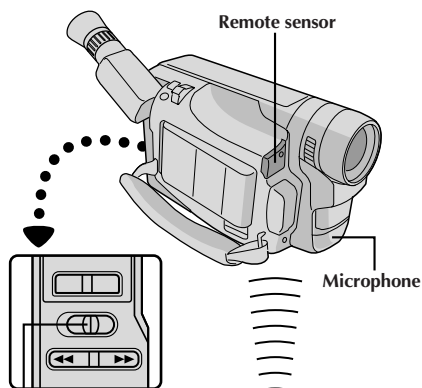
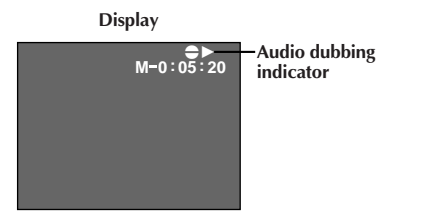

Audio Dubbing

You can record a new soundtrack on a prerecorded tape (normal audio only).

Perform steps **1**, **2** and **3** of the Insert Editing (VIDEO) procedure (pg. 64) before continuing.

- The sound comes from the built-in microphone.

1 FIND EDIT-IN POINT

Press **REW** to go a little beyond the beginning of the scene onto which you want to dub the new audio, press **PLAY** to view the recorded tape, then press **PAUSE** at exactly the point where dubbing should start.

2 ENGAGE AUDIO DUB-STANDBY MODE

Press and hold **A. DUB**, and without releasing **A. DUB**, press and release **PAUSE**.

3 BEGIN AUDIO DUBBING

Press **PLAY**. When the counter reaches "0:00:00", Audio Dubbing stops automatically and the camcorder enters the Audio Dub-Standby mode.

4 END AUDIO DUBBING

Press **STOP**.

NOTES:

- Do not press **FF** or **REW** during Audio Dub-Standby, or the edit points will not be accurate.
- If the microphone is too close to the TV, or if the TV's volume is too high, whistling or howling may occur.

NOTES (for Insert Editing and Audio Dubbing):

- Insert Editing and Audio Dubbing may not work correctly if the tape contains blank segments, or if the recording speed was changed during the original recording.
- To edit/dub onto a tape, make sure the Erase Protection tab is in the position that allows recording. If not, slide the tab. Some cassettes have removable tabs. If the tab has been removed, cover the hole with adhesive tape.
- Do not press **STOP** during Insert Editing or Audio Dubbing, or the edit points will not be accurate.
- During Insert Editing and Audio Dubbing, when Insert-Pause or Audio Dub-Standby is engaged, the counter may go slightly past "0:00:00". Recording, however, stops at exactly 0:00:00.

If, after following the steps in the chart below, the problem still exists, please consult your JVC dealer.

The camcorder is a microcomputer-controlled device. External noise and interference (from a TV, a radio, etc.) might prevent it from functioning properly. In such cases, first disconnect its power supply unit (battery pack, AC Power Adapter/Battery Charger, etc.) and clock battery; and then re-connect it and proceed as usual from the beginning.

SYMPTOM	POSSIBLE CAUSE(S)
POWER	
No power is supplied.	<ul style="list-style-type: none"> ● The battery pack has not been attached correctly (☞ pg. 8). ● The battery pack is not charged (☞ pg. 8). ● The power supply has not been correctly connected (☞ pg. 9).
The power suddenly goes off and does not come back on by itself.	<ul style="list-style-type: none"> ● The battery pack has completely discharged. ● Remove the cassette and disconnect the power source, then after a few minutes, try turning the power back on. If it still doesn't come on, consult your nearest JVC dealer.
OTHER	
Some functions are not available.	<ul style="list-style-type: none"> ● The Power Switch is set to "AUTO". ● Certain combinations of modes or effects are not possible to use.
During recording, the indications do not appear.	<ul style="list-style-type: none"> ● Press DISPLAY for longer than 1 second to make the indications appear (☞ pg. 17).
Vertical white lines appear when shooting a very bright object.	<ul style="list-style-type: none"> ● This sometimes occurs when the contrast between the background and the object is great. It is not a defect of the camcorder.
Bright, crystal-shaped spots appear in the LCD monitor and the viewfinder.	<ul style="list-style-type: none"> ● Sunlight is directly entering the lens. This is not a defect of the camcorder.
The rear of the LCD monitor is hot.	<ul style="list-style-type: none"> ● The light used to illuminate the LCD monitor causes it to be hot. Close the LCD monitor to turn it off or set the power switch to "OFF", and let the unit cool down.
Coloured bright spots appear all over the LCD monitor or the viewfinder.	<ul style="list-style-type: none"> ● The LCD monitor and the viewfinder are made with high-precision technology. However, black spots or bright spots of light (red, green or blue) may appear constantly on the LCD monitor or in the viewfinder. These spots are not recorded on the tape. This is not due to any defect of the unit. (Effective dots: more than 99.99 %.)
The indicators and the picture colour on the LCD monitor are not clear.	<ul style="list-style-type: none"> ● This may occur when the surface or the edge of the LCD monitor is pressed.
The LCD monitor, the viewfinder and the lens have become dirty (ex. fingerprints).	<ul style="list-style-type: none"> ● Wipe them gently with soft cloth. Gently wipe the LCD monitor in a semicircle because wiping strongly spreads the stain and it won't come out easily.
An error number (i.e. E03) appears.	<ul style="list-style-type: none"> ● Turn the camcorder's power off, then disconnect the power source. After a few minutes, try turning the power on again. If the error number still appears, consult your nearest JVC dealer.
The image is out of focus.	<ul style="list-style-type: none"> ● The dioptre needs to be adjusted (☞ pg. 14). ● The scene being shot is adversely affecting the operation of Auto Focus (☞ pg. 38).
Even though the Lens Cover is open, the Lens Cover Warning indicator blinks.	<ul style="list-style-type: none"> ● The Lens Cover Warning indicator may blink when the camcorder is used in dark areas, regardless of the position of the Lens Cover.

When the System Select Switch is set to "VIDEO":

SYMPTOM	POSSIBLE CAUSE(S)
RECORDING	
Recording cannot be performed.	<ul style="list-style-type: none"> ● Make sure the Erase Protection tab is in the position that allows recording. If not, slide the tab. Some cassettes have removable tabs. If the tab has been removed, cover the hole with adhesive tape (☞ pg. 13). ● If the System Select Switch is set to "D.S.C.", it is not possible to record onto the tape. Change the Switch position to "VIDEO" (☞ pg. 16).
Animation or Time-Lapse is not available.	<ul style="list-style-type: none"> ● Before recording in the Animation mode at the very beginning of a tape, set the camcorder to the Recording mode for about 5 seconds, so that the tape runs smoothly. Using the Fade-in function at this point is a good way to begin an animated programme (☞ pg. 43, 59).
Recording does not start.	<ul style="list-style-type: none"> ● The camcorder Power Switch has not been set to "CAMERA" ("AUTO" or "PRO.") (☞ pg. 16).
PLAYBACK	
The tape is running, but there is no playback picture.	<ul style="list-style-type: none"> ● The TV has not been set to its VIDEO mode or channel. ● If A/V connection is used, the TV's VIDEO/TV Switch has not been set to VIDEO.
Playback cannot be performed.	<ul style="list-style-type: none"> ● If the System Select Switch is set to "D.S.C.", it is not possible to play back a tape. Change the Switch position to "VIDEO" (☞ pg. 44).
Playback picture is blurred or interrupted.	<ul style="list-style-type: none"> ● The video heads are dirty or worn out. Consult your nearest JVC dealer for head cleaning or replacement.
The counter indication is blurred during Still playback.	<ul style="list-style-type: none"> ● This is normal.
TAPE TRANSPORT	
The tape stops during fast-forward or rewind.	<ul style="list-style-type: none"> ● The Counter Memory Function has been activated (☞ pg. 46).
Rewinding or fast-forwarding cannot be performed.	<ul style="list-style-type: none"> ● The tape is already fully wound on one reel or the other.
OTHER	
The picture is blurred in the Quick Review or Retake mode.	<ul style="list-style-type: none"> ● This is normal while recording in the LP mode. Some noise may be present while recording in the SP mode (☞ pg. 12).
The date and time displays disappear.	<ul style="list-style-type: none"> ● If you remove the power source from the camcorder while the power is on, all settings and selections are erased. Make sure to turn the camcorder's power off before disconnecting the power source.
The wrong date and time are displayed/recorded.	<ul style="list-style-type: none"> ● If you have not performed Date/Time Setting (☞ pg. 11), the date and time are not displayed/recorded correctly. Be sure that Date/Time setting is carried out.
The tape will not eject.	<ul style="list-style-type: none"> ● The battery pack is running low. ● If the LCD monitor is not open over 60 degrees, EJECT switch does not function.

When the System Select Switch is set to “D.S.C.”:

SYMPTOM	POSSIBLE CAUSE(S)
SHOOTING	
Although the SNAPSHOT Button is pressed, a still image is not stored in the built-in memory.	<ul style="list-style-type: none"> When the number of remaining shots available reaches “0” (blinking), it becomes impossible to take your next shot. Perform “DELETE” function to remove some still images already stored in memory (☞ pg. 56).
Self-Timer Shooting is not available.	<ul style="list-style-type: none"> Pressing the Recording Start/Stop Button does not start recording in the Self-Timer Shooting procedure. Press the SNAPSHOT Button (☞ pg. 42).
It is not possible to shoot in succession.	<ul style="list-style-type: none"> A still image is in the process of being stored in memory for approx. 2 seconds after the SNAPSHOT Button is pressed. During that time, it is impossible to take another shot. When the still image disappears and the scene you are currently aimed at appears on the screen, take another shot (☞ pg. 20).
PLAYBACK	
Although “ALL” is selected in the DELETE Menu Screen, all still images cannot be deleted.	<ul style="list-style-type: none"> The “Protect” function is in effect for some still images. If they are not necessary, cancel the “Protect” function, then try deleting all still images again (☞ pg. 55).
OTHER	
Date/Time Insert is not performed while shooting a still image.	<ul style="list-style-type: none"> It is not possible to display the date/time on a still image.
Instant Titles are not displayed while shooting a still image.	<ul style="list-style-type: none"> It is not possible to display the Instant Titles on a still image.
Some settings cannot be changed in the Menu Screen.	<ul style="list-style-type: none"> It is not possible to set “REC TIME” in the Menu Screen.

Since the camcorder is a microcomputer-controlled device, external noise and interference (from a TV, a radio, etc.) might prevent it from functioning properly. For example, when a still image you shot is stored in the camcorder's built-in memory, the above may cause the following: Although the remaining number of shots indicator shows that shooting is possible, a still image cannot be stored in memory after shooting. In such a case, initialize the memory by following steps 1 through 3 below. Please note that initialization deletes all the still images (including ones for which you performed the “Protect” function) stored in the camcorder's memory. If you wish to keep any of the still images that are stored in memory, before initialization first transfer them to a PC and save them. If image data is corrupt, transfer is impossible.

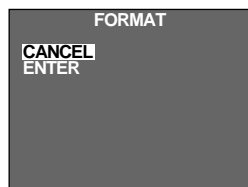

FORMAT Menu







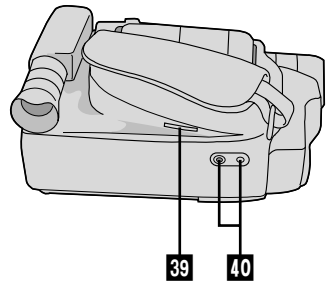
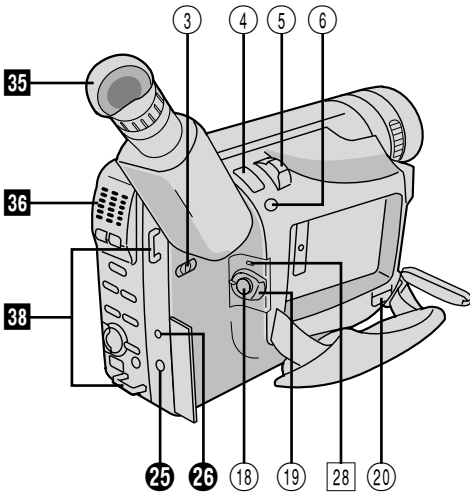
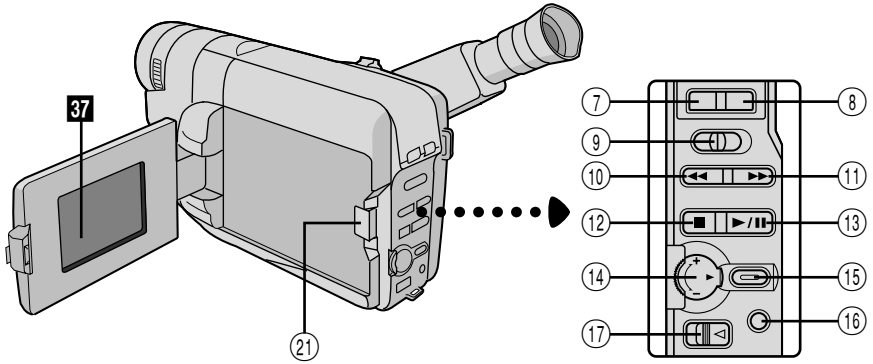
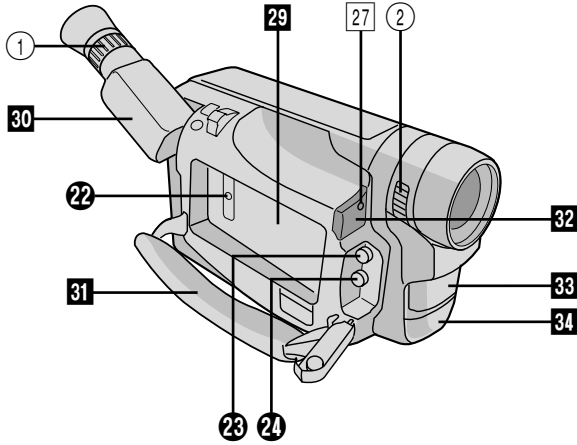



















- Set the System Select Switch to “D.S.C.”, then set the Power Switch to “PLAY”.
- Press the **SP/LP** Recording Mode Button for more than 2 seconds. The **FORMAT** Menu Screen appears.
- Rotate the Select Dial to move the highlight bar to “CANCEL” or “ENTER”, then press it.
 - “CANCEL” does not initialize the memory.
 - “ENTER” initializes the memory. During initialization, “ENTER” blinks. When initialization is complete, the screen becomes blue back.

CAUTION:





While “ENTER” is selected and it is blinking, switching off the camcorder or removing the power supply unit (battery pack or AC Power Adapter/Charger) may cause the camcorder's built-in memory to become corrupt. **Never remove the power supply unit at this stage.**





Controls

- ① Dioptre Adjustment Control  pg. 14
- ② Lens Cover Open/Close Ring  pg. 16
- ③ Video Light Switch
[LIGHT OFF/AUTO/ON]  pg. 28
- ④ Snapshot Button [SNAPSHOT]  pg. 20, 24
- ⑤ • Power Zoom Lever [T/W]  pg. 26
• Speaker Volume Control [VOL.]  pg. 45
- ⑥ Picture Stabilizer Button
[P.STABILIZER]  pg. 27
- ⑦ Programme AE Button [P.AE]  pg. 30
- ⑧ Fade/Wipe Button [EFFECT]  pg. 29
- ⑨ System Select Switch
[D.S.C./VIDEO]  pg. 16, 20, 44, 50
- ⑩ • Rewind Button
[◀, REW/PAGE-]  pg. 44, 50
• Retake Rewind Button [RETAKE R]  pg. 27
• Quick Review Button [◻ R]  pg. 27
- ⑪ • Fast-Forward Button
[▶▶, FF/PAGE+]  pg. 44, 50
• Retake Forward Button [RETAKE F]  pg. 27
- ⑫ Stop Button [■, STOP]  pg. 44
- ⑬ Play/Pause Button
[▶/⏸, PLAY/PAUSE]  pg. 44
- ⑭ • Select Dial [+ , - , PUSH]  pg. 11, 34
• Bright Dial [BRIGHT]  pg. 19
- ⑮ MENU/DISPLAY Button  pg. 17, 34
- ⑯ • Counter Reset/Memory Button
[COUNTER R/M]  pg. 46
• Recording Mode Button [SP/LP]  pg. 12
- ⑰ EJECT Switch  pg. 13
- ⑱ Recording Start/Stop Button  pg. 16
- ⑲ Power Switch  pg. 16, 20, 44, 50
- ⑳ Battery Release Switch
[BATTERY RELEASE]  pg. 8
- ㉑ PUSH Button  pg. 13













Connectors

- ㉒ DC IN Jack  pg. 9
- The connectors ㉓ to ㉖ are located beneath the cover.
- ㉓ Video Output Connector  pg. 48
 - ㉔ Audio Output Connector  pg. 48
 - ㉕ J Terminal [JLIP (Joint Level Interface Protocol) Connector]
 - Connect the editing cable when performing Random Assemble Editing ( pg. 60 – 63).
 - It is used to connect the camcorder to a device such as a personal computer.
For further details consult your nearest JVC dealer.
 - JLIP-controlled editing from camcorder to VCR is not possible if the VCR is not equipped with a J terminal.
 - ㉖ Digital Connector  pg. 51









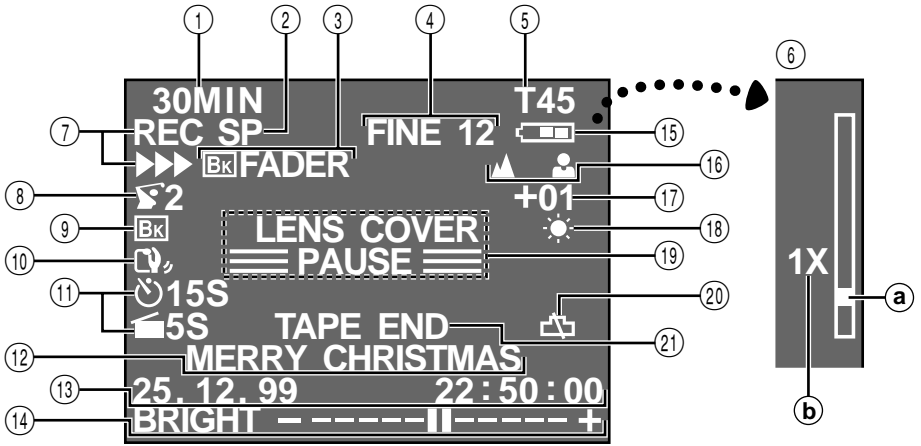























Indicators

- ㉗ Tally Lamp  pg. 16
- ㉘ Power Lamp  pg. 16

Other Parts

- ㉙ Battery Pack Mount  pg. 8
- ㉚ Viewfinder  pg. 14
- ㉛ Grip Strap  pg. 14
- ㉜ • Camera sensor
Be careful not to cover this area; a sensor necessary for shooting is built-in here.
• Remote sensor  pg. 59
- ㉝ Video Light  pg. 28
- ㉞ Microphone  pg. 66
- ㉟ Eyepiece  pg. 78
- ㊱ Speaker  pg. 45
- ㊲ LCD Monitor  pg. 19
- ㊳ Shoulder Strap Eyelets  pg. 15
- ㊴ Clock Battery Slot  pg. 10
- ㊵ Tripod Mounting Socket  pg. 15



- ① **Cassette Warning/**
Tape Remaining Time  pg. 17
When no cassette is inserted: the cassette () warning blinks.
When the Erase Protection tab is not in the position that allows recording: the cassette () warning lights. Otherwise, the tape remaining time is displayed and the tape remaining time warning blinks when the tape is about to reach its end.
When the Power Switch is set to "PLAY" and a tape is loaded: the cassette () mark is displayed regardless of the Erase Protection tab's position.
- ② **Recording Mode (SP/LP) Indicator**  pg. 12
- ③, ⑧ **Programme AE Indicator**  pg. 30
Displayed at ③ for approx. 2 seconds when Programme AE with special effects is switched from one mode to another by pressing **P.AE.**, then only the indicator remains at ⑧.
- ③, ⑨ **Fade/Wipe-Standby Indicator**  pg. 29
Displayed at ③ for approx. 2 seconds when the Fade/Wipe is switched from one effect to another by pressing **EFFECT**, then only the indicator remains at ⑨.
- ④ • **Picture Mode Display**  pg. 21, 22
• **Remaining Number Of Shots Indicator**  pg. 21, 22
- ⑤ **Tape Length Indicator**  pg. 12
- ⑥ **Zoom Indicator Bar**  pg. 26
Ⓐ **Zoom Level Indicator**
Ⓑ **Approximate Zoom Ratio**
- ⑦ **Recording Indicator**  pg. 16
- ⑩ **Picture Stabilizer Indicator**  pg. 27
- ⑪ **Interval Timer/Recording Time Indicator**  pg. 42, 59
- ⑫ **Instant Title Display**  pg. 33
- ⑬ **Date/Time Display**  pg. 32
- ⑭ • **Bright Level Indicator**  pg. 45
• **Speaker Volume Indicator**  pg. 45
- ⑮ **Battery Pack Remaining Power Indicator**
Changes as follows according to the battery pack's remaining power level:
"→→→". When the power is almost gone, the indicator "" blinks (battery power warning), then the unit shuts off. Replace the battery pack with a fully charged one.
Note: The symbol containing 3 darkened squares —  — does not necessarily mean that the battery pack is fully charged.
- ⑯ **Focus Indicator**  pg. 38
- ⑰ **Exposure Control Level Counter**  pg. 37
- ⑱ **White Balance Mode Indicator**  pg. 40
- ⑲ • **Record-Standby Mode Indicator**  pg. 16
• **Lens Cover Warning:**
LENS COVER  pg. 17
- ⑳ **Clock Battery Warning**
Blinks for approx. 10 seconds when the power is turned on. This display also blinks when the clock (lithium) battery is either not installed or has discharged. Install or replace the old battery with a new one ( pg. 10).
- ㉑ • **Tape End Display: TAPE END**  pg. 17
Appears when the end of the tape is reached during playback, recording or fast-forward.
• **Condensation Warning:** 
When this indication appears, all functions except tape eject and power on/off are disabled. Turn the unit off (without removing the power source) for a few hours, and when you turn it on again the indication should disappear.
• **Head Clog Warning:** 
Appears if dirty heads are detected during recording. In such a case, use the optional Cleaning Cassette. If, after using it, the problems still exist, consult your nearest JVC dealer.

A

AC Power Adapter/Charger	pg. 8
Animation Recording	pg. 43, 59
Audio Dubbing	pg. 66
Auto Date Record	pg. 32
Auto Focus	pg. 38
Auto Shut Off	pg. 17, 44

B

Battery Pack	pg. 8, 77
Brighten The LCD Monitor	pg. 19

C

Car Battery	pg. 9
Cassette Adapter	pg. 47
Charge Marker	pg. 9
Charging The Battery Pack	pg. 8
Clean The Camcorder	pg. 76
Clock (Lithium) Battery	pg. 10
COM Port (RS-232C)	pg. 51
Connection To A VCR/TV	pg. 48
Connection To A Windows PC/Macintosh	pg. 51
Contents	Cover page
Counter Memory	pg. 46

D

Darken The LCD Monitor	pg. 19
Date/Time Display	pg. 32
Date/Time Settings	pg. 11
DELETE Menu	pg. 56
Delete Mode	pg. 56
Delete Select Menu	pg. 56
Demonstration Mode	pg. 36
Digital Zoom	pg. 35
Digital Still Camera	pg. 20 – 23
Dioptr Adjustment	pg. 14
Discharge The Battery Pack	pg. 8

E

Electronic Fog Filter Mode	pg. 31
Erase Protection	pg. 13
Exposure Control	pg. 37

F

Fade-In/Out	pg. 29
Fast-Forward Tape	pg. 44
FINE Mode	pg. 22
Full Image	pg. 21, 25

G

Grip Adjustment	pg. 14
-----------------------	--------

H

High Speed Shutter Mode	pg. 31
-------------------------------	--------

I

INDEX Menu	pg. 54
Index Mode	pg. 54
Index Number	pg. 54
Insert Editing	pg. 64, 65
Instant Titles	pg. 33
Interface Shooting	pg. 19

J

JLIP ID NO.	pg. 36
Journalistic Shooting	pg. 19
JPEG	pg. 22

L

LCD monitor/Viewfinder, Indications	pg. 72, 73
Load A Tape	pg. 13

M

Manual Focus	pg. 39
Menu Screen	pg. 35, 36, 53
Modem Port	pg. 51
Move The Page Back	pg. 50
Move The Page Next	pg. 50

N

ND Effect Mode	pg. 31
Nega/Posi Mode	pg. 31

P

Padlock Mark	pg. 55
Picture Mode Setting	pg. 22
Picture Stabilizer	pg. 27
Pin-Up Image	pg. 21, 25
Playback (D.S.C.)	pg. 50
Playback (VIDEO)	pg. 44
Power Switch Position	pg. 16
Printer Port	pg. 51
Program AE With Special Effects	pg. 30, 31
PROTECT Menu	pg. 55
Protect Mode	pg. 55
Provided Accessories	pg. 5

Q

Quick Review	pg. 27
--------------------	--------

R

Recording, Advanced Features (VIDEO) ...	pg. 29 – 43
Recording, Start/Stop (VIDEO)	pg. 16, 17
Recording Mode	pg. 12
Record-Standby	pg. 16
Remote Control	pg. 58
Retake	pg. 27
Rewind The Tape	pg. 44

S

Self-Recording	pg. 19
Self-Timer	pg. 42, 59
Sepia Mode	pg. 31
Shooting,	
Advanced Features (D.S.C.)	pg. 30, 35 – 42
Shooting (D.S.C.)	pg. 20 – 23
Shoulder Strap Attachment	pg. 15
Shuttle Search	pg. 46
Slide Show Mode	pg. 53
Snapshot Mode	pg. 20, 24
Snapshot (VIDEO)	pg. 24, 25
Specifications	pg. 80
Sports Mode	pg. 31
STANDARD Mode	pg. 22
Star Mark On The Setting Menus	pg. 54, 55, 57
Still Image Data Transfer	pg. 51
Still Playback	pg. 46
Store A Still Image In The Built-In Memory	pg. 20
Super LoLux (S.LX)	pg. 35

T

Tally	pg. 36
Tape Counter	pg. 44
Tape Dubbing	pg. 48, 49
Tape Length Setting	pg. 12
Tele Macro	pg. 36
Time-Lapse Shooting	pg. 43, 59
Tracking	pg. 45
Tripod Mounting	pg. 15
Twilight Mode	pg. 31

U

Unload A Tape	pg. 13
---------------------	--------

V

Video Light	pg. 28
-------------------	--------

W

White Balance Adjustment	pg. 40
Wide Mode	pg. 35
Wipe-In/Out	pg. 29

Z

Zooming	pg. 26
---------------	--------

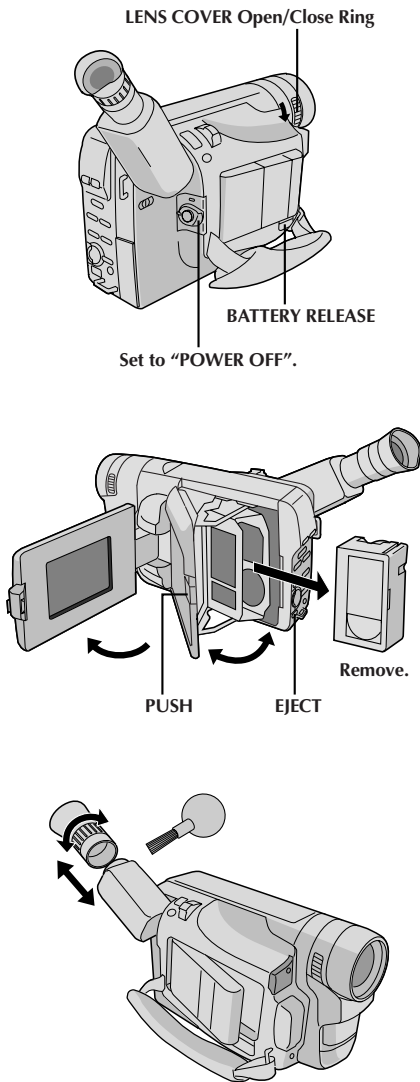

After Use

- 1** Set the Power Switch to "POWER OFF" to turn off the camcorder.
- 2** Open the LCD monitor to an angle of over 60 degrees. Slide **EJECT** to open the cassette holder, then remove the cassette.
- 3** Close and lock the cassette holder by pressing **PUSH**.
- 4** Close and lock the LCD monitor.
- 5** Slide **BATTERY RELEASE** to remove the battery pack.
- 6** Turn the **LENS COVER Open/Close Ring** to close the lens cover.

Cleaning The Camcorder

- 1 CLEAN EXTERIOR**
Wipe gently with a soft cloth.
 - Put cloth in diluted mild soap and wring it well to wipe off heavy dirt, then wipe again with a dry cloth.
- 2 CLEAN LCD MONITOR**
Open the LCD monitor and wipe it gently with a soft cloth. Be careful not to damage the monitor. Close the LCD monitor.
- 3 CLEAN LENS**
Blow it with a blower brush, then wipe it gently with lens cleaning paper.
- 4 REMOVE EYEPIECE**
Turn the eyepiece counterclockwise and pull it out.
- 5 CLEAN VIEWFINDER**
Remove dust using a blower brush.
- 6 RE-ATTACH EYEPIECE**
Re-attach the eyepiece and turn it clockwise.

NOTES:

- Avoid using strong cleaning agents such as benzine or alcohol.
- Cleaning should be done only after the battery pack has been removed or other power units have been disconnected.
- Mould may form if the lens is left dirty.
- When using a cleaner or chemically treated cloth, refer to the cautions that came with it.
- When removing the eyepiece, be sure to hold the viewfinder securely.

DANGER:**Video Light**

- The video light becomes extremely hot. Do not touch it either while in operation or soon after turning it off, otherwise serious injury may result.
- Do not place the camcorder into the carrying case immediately after using the video light, since it remains extremely hot for some time.
- When operating, keep a distance of about 30 cm between the video light and people or object.
- Do not use near flammable or explosive materials.
- It is recommended that you consult your nearest JVC dealer for replacing the video light.

General Battery Precautions

- When the C-P6U or C-P7U (cassette adapter) is not functioning even when correctly operated, the battery is exhausted. Replace it with a fresh one.
- Use only the following battery:
C-P6U or C-P7U R6 (AA) size

Please make note of the following rules for battery use. When misused, battery can leak or explode.

1. Refer to the C-P6U/C-P7U instructions when replacing the battery.
2. **Do not** expose the battery to excessive heat as it can leak or explode.
3. **Do not** dispose of battery in a fire.
4. Remove battery from the unit if it is to be stored for an extended period to avoid battery leakage which can cause malfunctions.

Battery Packs

The battery packs are nickel-cadmium or nickel metal-hydride batteries. Before using the supplied battery pack or an optional battery pack, be sure to read the following cautions:

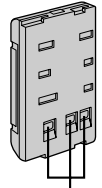
**1. To avoid hazard . . .**

- ... **do not** burn.
- ... **do not** short-circuit the terminals.
- ... **do not** modify or disassemble.
- ... use only specified chargers.

2. To prevent damage and prolong service life . . .

- ... **do not** subject to unnecessary shock.
- ... avoid repeated charging without fully discharging.
- ... charge in an environment where temperatures are within the tolerances shown in the chart below. This is a chemical reaction type battery—cooler temperatures impede chemical reaction, while warmer temperatures can prevent complete charging.
- ... store in a cool, dry place. Extended exposure to high temperatures will increase natural discharge and shorten service life.
- ... avoid prolonged uncharged storage.
- ... remove from charger or powered unit when not in use, as some machines use current even when switched off.

NOTES:

- *It is normal for the battery pack to be warm after charging, or after use.*
Temperature Range Specifications
Charging 10°C to 35°C
Operation 0°C to 40°C
Storage -10°C to 30°C
- *Recharging time is based on room temperature of 20°C.*
- *The lower the temperature, the longer recharging takes.*

Cassettes

To properly use and store your cassettes, be sure to read the following cautions:

1. During use . . .

- ... make sure the cassette bears the VHS-C mark.
- ... be aware that recording onto prerecorded tapes automatically erases the previously recorded video and audio signals.
- ... make sure the cassette is positioned properly when inserting.
- ... do not load and unload the cassette repeatedly without allowing the tape to run at all. This slackens the tape and can result in damage.
- ... do not open the front tape cover. This exposes the tape to fingerprints and dust.

2. Store cassettes . . .

- ... away from heaters or other heat sources.
- ... out of direct sunlight.
- ... where they won't be subject to unnecessary shock or vibration.
- ... where they won't be exposed to strong magnetic fields (such as those generated by motors, transformers or magnets).
- ... vertically, in their original cases.

Main Unit

1. For safety, DO NOT . . .

- ... open the camcorder's chassis.
- ... disassemble or modify the unit.
- ... short-circuit the terminals of the battery pack. Keep it away from metallic objects when not in use.
- ... allow inflammables, water or metallic objects to enter the unit.
- ... remove the battery pack or disconnect the power supply while the power is on.
- ... leave the battery pack attached when the camcorder is not in use.

2. Avoid using the unit . . .

- ... in places subject to excessive humidity or dust.
- ... in places subject to soot or steam such as near a cooking stove.
- ... in places subject to excessive shock or vibration.
- ... near a television set.
- ... near appliances generating strong magnetic or electric fields (speakers, broadcasting antennas, etc.).
- ... in places subject to extremely high (over 40°C) or extremely low (under 0°C) temperatures.

3. DO NOT leave the unit . . .

- ... in places of over 50°C.
- ... in places where humidity is extremely low. (below 35%) or extremely high (above 80%).
- ... in direct sunlight.
- ... in a closed car in summer.
- ... near a heater.

4. To protect the unit, DO NOT . . .

- ... allow it to become wet.
- ... drop the unit or strike it against hard objects.
- ... subject it to shock or excessive vibration during transportation.
- ... keep the lens directed at extremely bright objects for long periods.
- ... direct the eyepiece of the viewfinder at the sun.
- ... carry it by holding the viewfinder or the LCD monitor. Be sure to hold the main unit with both hands or use the grip.
- ... swing it excessively when using the shoulder strap.

LCD Monitor

1. To prevent damage to the LCD monitor, DO NOT . . .

- ... push it strongly or apply any shocks.
- ... place the camcorder with the LCD monitor on the bottom.

2. To prolong service life . . .

- ... avoid rubbing it with coarse cloth.

3. Be aware of the following phenomena for LCD monitor use. These are not malfunctions . . .

- While using the camcorder, the surface around the LCD monitor and/or the back of the LCD monitor may heat up.
- If you leave power on for a long time, the surface around the LCD monitor becomes hot.

How to handle a CD-ROM

- Take care not to soil or scratch the mirror surface (opposite to the printed surface). Do not write anything or put a sticker on either the front or back surface. If the CD-ROM gets dirty, gently wipe it with a soft cloth outward from the centre hole using a circular motion.
- Do not use conventional disc cleaners or cleaning spray.
- Do not bend the CD-ROM or touch its mirror surface.
- Do not store your CD-ROM in a dusty, hot or humid environment. Keep it away from direct sunlight.

About moisture condensation . . .

- You may have observed that pouring a cold liquid into a glass will cause drops of water to form on the glass' outer surface. This same phenomenon occurs on the head drum of a camcorder when it is moved from a cool place to a warm place, after heating a cold room, under extremely humid conditions or in a place directly subjected to the cool air from an air conditioner.
- Moisture on the head drum can cause severe damage to the video tape, and can lead to internal damage to the camcorder itself.

Serious malfunctioning

If malfunctioning occurs, stop using the unit immediately and consult your local JVC dealer.

SPECIAL NOTES ON VIDEO HEADS

Dust and dirt on video heads

1. **Always allow enough time for your camcorder to acclimatize to its environment before using it.**
2. **Do not use the unit in areas of high humidity. (Typical areas of high humidity are given below.)**
 - From being used or stored in a very cold outdoor situation, then immediately being used in a warm indoor situation.
 - From being used or stored in a cool air-conditioned situation, then being used in a high-humidity outdoor situation.
 - Other areas where rapid large temperature changes can occur.
3. **Taking care of your "C" format video cassette tapes.**
 - Store the video cassette tapes in a vertical position, complete in their cassette cases.
 - During transportation, always store cassettes in their cassette cases.
4. **Check recorded information at regular intervals.**

If the camcorder is equipped with a quick review facility, use this facility to check whether the picture is clear or not.

If the quick review or playback picture is not clear, then the video heads may be dirty.

NOTE:

As a maladjusted tracking control can give similar symptoms to dirty video heads, please check that the tracking control of the unit is in the centre position.

Cleaning the video heads

Accumulation of dirt and other particles on the video heads may cause the playback picture to become blurred or interrupted. Although this camcorder is equipped with a built-in head cleaner which automatically cleans the heads, reducing the likelihood of dirty heads, if such troubles are encountered, we recommend the use of the cleaning cassette specifically designed for JVC camcorders, model number TCC-2U. Please use the cleaning cassette as indicated below:

- ① After inserting the cleaning cassette, activate the Play mode for a maximum of 15 seconds (normally, 5 seconds is sufficient).
- ② Remove the cleaning cassette and check the playback picture with a previously good-recorded tape.
- ③ If the picture is clear, then recording on a new tape can begin when desired.
- ④ If the picture is not clear, repeat steps 1 to 3 up to two more times.
- ⑤ If the picture is still unclear, consult your local JVC dealer.



Important Note:

If heads have become dirty, the associated tape will also be damaged, please do not use the tape again.



- *A built-in head cleaner automatically cleans the video heads and head drum whenever a cassette is loaded and unloaded to reduce head clogging.*
- *Cleaning cassette TCC-2U is available from your JVC local dealer.*

Camcorder

General

Format	: VHS PAL standard	Operating temperature	: 0°C to 40°C
Power source	: DC 6.0 V 	Operating humidity	: 35% to 80%
Power consumption		Storage temperature	: -20°C to 50°C
LCD monitor off, viewfinder on	: 6.5 W	Weight	: Approx. 890 g
LCD monitor on, viewfinder off	: 7.0 W	Dimensions	: 99 (W) x 119 (H) x 198 (D) mm (with the LCD monitor closed and with the viewfinder fully tilted downward)
LCD monitor on, viewfinder on	: 7.6 W	Pickup	: 1/4" format CCD
Video light	: 2.9 W	Lens	: F1.6, f = 3.9 to 62.4 mm, 16:1 power zoom lens with auto iris and macro control, filter diameter 40.5 mm
Signal system	: PAL-type	Viewfinder	: Electronic viewfinder with 0.5" black/white CRT
Video recording system		White balance adjustment	: Auto/Manual adjustment
Luminance	: FM recording	LCD monitor	: 2.5" diagonally measured, LCD panel/TFT active matrix system
Colour	: Converted sub-carrier direct recording Conforms to VHS standard	Speaker	: Monaural
Cassette	:  cassette	Connectors	
Tape speed		JLIP	: ø3.5 mm, 4-pole, mini-head jack (compatible with RC-5325 plug)
SP	: 23.39 mm/sec.	Video	: 1 Vp-p, 75 Ω unbalanced, analogue output (via Video output connector)
LP	: 11.70 mm/sec.	Audio	: -8 dBs, 1 kΩ analogue output (via Audio output connector)
Recording time (max.)		Digital	: ø2.5 mm, 4-pole, mini-head jack
SP	: 60 minutes		
LP	: 120 minutes (with EC-60 cassette)		
D.S.C. format			
Recording format	: Digital data storage (based on JPEG)		
Recording medium	: Built-in flash memory, 2 Mbyte		
Number of storable shots	: FINE mode: approx. 30 shots STANDARD mode: approx. 60 shots		
Image size	: 640 x 480 pixels		

AC Power Adapter/Charger AA-V15EK

Power requirement	: AC 110 V to 240 V \sim , 50/60 Hz
Power consumption	: 23 W
Output	
Charge	: DC 8.5 V  , 1.3 A
VTR	: DC 6.3 V  , 1.8 A
Charging system	: Constant current, peak detection, timer controlled
Dimensions	: 140 (W) x 42 (H) x 68 (D) mm
Weight	: Approx. 350 g

Cassette Adapter C-P7U

Dimensions	: 188 (W) x 25 (H) x 104 (D) mm
Weight	: Approx. 240 g
Accessory	: "R6 (AA)"-size battery x 1

Provided Accessories  pg. 5

Optional Accessories

- Battery Packs BN-V12U, BN-V20U, BN-V856U
- Car Battery Charger BH-V3E
- Compact VHS-C () Cassettes EC-60/45/30
- Active Carrying Bag CB-V7U
- Remote Control Unit RM-V700U

Some accessories are not available in some areas. Please consult your nearest JVC dealer for details on accessories and their availability.

Specifications shown are for SP mode unless otherwise indicated.

E & O.E. Design and specifications subject to change without notice.

