

**Operator's manual**  
**Manuel d'utilisation**  
**Manual de instrucciones**

**128RJ**



Please read these instructions and make sure you understand them before using the machine.

Lire attentivement et bien assimiler le manuel d'utilisation avant d'utiliser la machine.

Lea detenidamente el manual de instrucciones y asegúrese de entender su contenido antes de utilizar la máquina.

**EN (2-27)**  
**FR (28-53)**  
**ES (54-79)**

# SYMBOL EXPLANATION

## Symbols

**WARNING:** Clearing saws, brush-cutters and trimmers can be dangerous! Careless or incorrect use can result in serious or fatal injury to the operator or others.



Please read the operator's manual carefully and make sure you understand the instructions before using the machine.



Always wear:

- A protective helmet where there is a risk of falling objects
- Hearing protection
- Approved eye protection



Max. speed of output shaft, rpm



Beware of thrown objects and ricochets.



The operator of the machine shall ensure, while working, that no persons or animals come closer than 15 metres.



Machines fitted with grass blades can be thrown violently to the side when the blade comes into contact with a fixed object. The blade is capable of amputating an arm or leg. Always keep people and animals at least 15 metres from the machine.



Arrows which show limits for handle mounting.



Always wear approved protective gloves.



Use anti-slip and stable boots.



Only use non-metallic, flexible cutting attachments, i.e. trimmer heads with trimmer line.



This product is in accordance with applicable EC directives.



Noise emission to the environment according to the European Community's Directive. The machine's emission is specified in the Technical data section and on label.



Sound pressure level at 7,5 metres.



Use unleaded or quality leaded petrol and two-stroke oil mixed at a ratio of 2% (1:50).



**Other symbols/decals on the machine refer to special certification requirements for certain markets.**

Stop the engine by pushing and holding the stop switch in the STOP position. **CAUTION!** The stop switch automatically returns to the start position. In order to prevent unintentional starting, the spark plug cap must be removed from the spark plug when assembling, checking and/or performing maintenance.



Regular cleaning is required.



Visual check.



Approved eye protection must always be used.



# CONTENTS

## Contents

<b>KEY TO SYMBOLS</b>	
Symbols .....	2
<b>CONTENTS</b>	
Contents .....	3
Note the following before starting .....	3
<b>WHAT IS WHAT?</b>	
What is what? .....	4
<b>GENERAL SAFETY PRECAUTIONS</b>	
Important .....	5
Personal protective equipment .....	5
Machine's safety equipment .....	6
Cutting equipment .....	8
<b>ASSEMBLY</b>	
Fitting the handlebar .....	10
Fitting the harness and harness clamp .....	10
Fitting blades and trimmer heads .....	11
Fitting a blade guard, grass blade and grass cutter .....	11
Fitting the trimmer guard and trimmer head .....	12
<b>FUEL HANDLING</b>	
Fuel safety .....	13
Fuel .....	13
Fuelling .....	14
<b>STARTING AND STOPPING</b>	
Check before starting .....	15
Starting and stopping .....	15
<b>WORKING TECHNIQUES</b>	
General working instructions .....	17
<b>MAINTENANCE</b>	
Carburetor .....	20
Muffler .....	20
Spark plug .....	21
Air filter .....	21
Bevel gear .....	21
Sharpening grass cutters and grass blades .....	22
Maintenance schedule .....	23
<b>TECHNICAL DATA</b>	
Technical data .....	24
EC-declaration of conformity (Applies to Europe only) .....	25

## Note the following before starting:

Please read the operator's manual carefully.

 **WARNING:** Under no circumstances may the design of the machine be modified without the permission of the manufacturer. Always use genuine accessories. Non-authorized modifications and/or accessories can result in serious personal injury or the death of the operator or others.

 **WARNING:** A clearing saw, brushcutter or trimmer can be dangerous if used incorrectly or carelessly, and can cause serious or fatal injury to the operator or others. It is extremely important that you read and understand the contents of this operator's manual.

 **WARNING:** Long-term exposure to noise can result in permanent hearing impairment. So always use approved hearing protection.

Husqvarna AB has a policy of continuous product development and therefore reserves the right to modify the design and appearance of products without prior notice.

## WHAT IS WHAT?

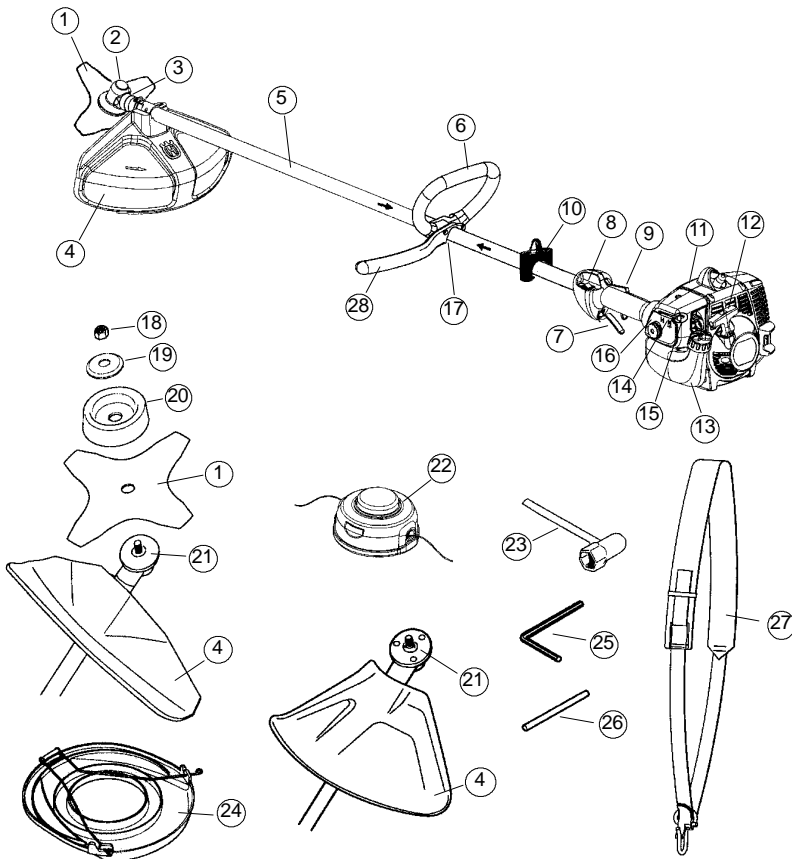

### What is what?

- |                             |                       |
|-----------------------------|-----------------------|
| 1. Blade                    | 16. Air filter cover  |
| 2. Grease filler cap        | 17. Handle adjustment |
| 3. Bevel gear               | 18. Locking nut       |
| 4. Cutting attachment guard | 19. Support flange    |
| 5. Shaft                    | 20. Support cup       |
| 6. Loop handle              | 21. Drive disc        |
| 7. Throttle control         | 22. Trimmer head      |
| 8. Stop switch              | 23. Socket spanner    |
| 9. Throttle lock-out        | 24. Transport guard   |
| 10. Harness clamp           | 25. Hex wrench        |
| 11. Cylinder cover          | 26. Locking pin       |
| 12. Starter handle          | 27. Harness           |
| 13. Fuel tank               | 28. J-handle          |
| 14. Choke control           | 29. Operator's manual |
| 15. Primer bulb             |                       |

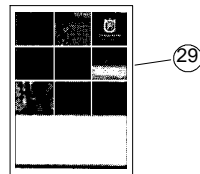

# GENERAL SAFETY PRECAUTIONS

## Important

**IMPORTANT!** The machine is only designed for trimming grass, grass clearing and/or forestry clearing.

The only accessories you can operate with this engine unit are the cutting attachments we recommend in the section on Technical data. Never use the machine if you are tired, if you have drunk alcohol, or if you are taking medication that could affect your vision, your judgement or your co-ordination.

Never use the machine in extreme weather conditions such as severe cold, very hot and/or humid climates.

Wear personal protective equipment. See instructions under the heading Personal protective equipment.

Never use a machine that has been modified in any way from its original specification.

Never use a machine that is faulty. Carry out the checks, maintenance and service instructions described in this manual. Some maintenance and service measures must be carried out by trained and qualified specialists. See instructions under the heading Maintenance. All covers and guards must be fitted before starting. Make sure the spark plug cap and lead are not damaged. Otherwise you could get an electric shock.

The machine operator must ensure that no people or animals come closer than 15 metres while working. When several operators are working in the same area, the safety distance should be at least 15 metres.

**WARNING:** Using an incorrect cutting attachment or an incorrectly filed blade can increase the risk of accidents.

**WARNING:** Never allow children to use or be in the vicinity of the machine. As the machine is equipped with a spring-loaded stop switch and can be started by low speed and force on the starter handle, even small children under some circumstances can produce the force necessary to start the machine. This can mean a risk of serious personal injury. Therefore remove the spark plug cap when the machine is not under close supervision.

## Personal protective equipment

**IMPORTANT!** A clearing saw, brushcutter or trimmer can be dangerous if used incorrectly or carelessly, and can cause serious or fatal injury to the operator or others. It is extremely important that you read and understand the contents of this operator's manual. You must use approved personal protective equipment whenever you use the machine. Personal protective equipment cannot eliminate the risk of injury but it will reduce the degree of injury if an accident does happen. Ask your dealer for help in choosing the right equipment.

**WARNING:** Listen out for warning signals or shouts when you are wearing hearing protection. Always remove your hearing protection as soon as the engine stops.

### HELMET

A helmet should be worn if the brush being cleared is taller than 2 metres.



### HEARING PROTECTION

Wear hearing protection that provides adequate noise reduction.

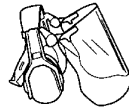

### EYE PROTECTION

Always wear approved eye protection. If you use a visor then you must also wear approved protective goggles. Approved protective goggles must comply with EN 166 in EU countries.

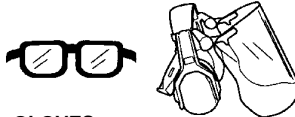

### GLOVES

Gloves should be worn when necessary, e.g., when fitting cutting attachments.



### BOOTS

Wear anti-slip and stable boots.



## GENERAL SAFETY PRECAUTIONS

### CLOTHING

Wear clothes made of a strong fabric and avoid loose clothing that can catch on shrubs and branches. Always wear heavy, long pants. Do not wear jewelry, shorts sandals or go barefoot. Secure hair so it is above shoulder level.

### FIRST AID KIT

A first aid kit should be carried by operators of clearing saws, brushcutters or trimmers.



### Machine's safety equipment

This section describes the machine's safety equipment, its purpose, and how checks and maintenance should be carried out to ensure that it operates correctly. See the "What is what" section to locate where this equipment is positioned on your machine. The life span of the machine can be reduced and the risk of accidents can increase if machine maintenance is not carried out correctly and if service and/or repairs are not carried out professionally. If you need further information please contact your nearest service workshop.

**IMPORTANT!** All servicing and repair work on the machine requires special training. This is especially true of the machine's safety equipment. If your machine fails any of the checks described below you must contact your service agent. When you buy any of our products we guarantee the availability of professional repairs and service. If the retailer who sells your machine is not a servicing dealer, ask him for the address of your nearest service agent.

**WARNING:** Never use a machine that has faulty safety equipment! Follow the control, maintenance and service instructions described in this section. If your machine fails any of these checks contact your service agent to get it repaired.

### Throttle lock-out

The throttle lock-out is designed to prevent accidental operation of the throttle control. When you press the lock-out (A) (i.e. when you grasp the handle) it releases the throttle control (B). When you release the handle, the throttle control and the throttle lock-out both move back to their original positions. This movement is controlled by two independent return springs. This arrangement means that the throttle control is automatically locked at the idle setting.

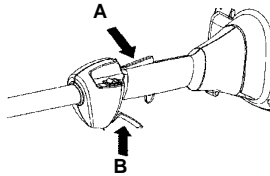

Make sure the throttle control is locked at the idle setting when the throttle lock-out is released.

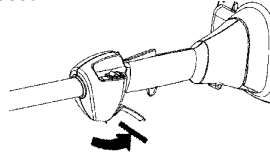

Press the throttle lock-out and make sure it returns to its original position when you release it.

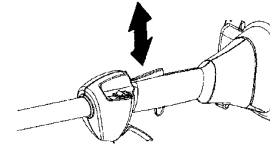

Check that the throttle control and throttle lock-out move freely and that the return springs work properly.

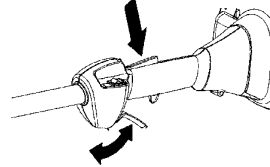

See instructions under the heading Start. Start the machine and apply full throttle. Release the throttle and check that the cutting attachment stops and remains at a standstill. If the cutting attachment rotates with the throttle in the idle position then the carburettor idle setting must be checked. See instructions under the heading Maintenance.

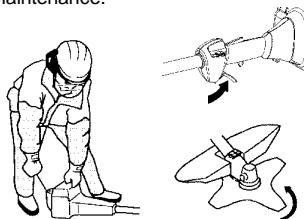

## GENERAL SAFETY PRECAUTIONS

### Stop switch

Make sure the engine stops when you push and hold the stop switch.

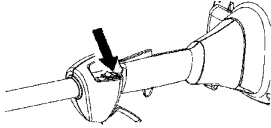

### Cutting attachment guard

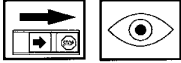

This guard is intended to prevent loose objects from being thrown towards the operator. The guard also protects the operator from accidental contact with the cutting attachment.

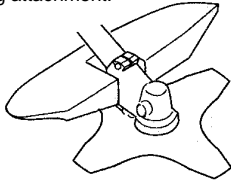

Check that the guard is undamaged and not cracked. Replace the guard if it has been exposed to impact or is cracked.

Always use the recommended guard for the cutting attachment you are using. See the "Technical data" section.

**WARNING:** Never use a cutting attachment without an approved guard. See the section on "Technical data". If an incorrect or faulty guard is fitted this can cause serious personal injury.

Use of incorrectly wound trimmer line or an incorrect cutting attachment increases the level of vibration.

**WARNING:** Overexposure to vibration can lead to circulatory damage or nerve damage in people who have impaired circulation. Contact your doctor if you experience symptoms of overexposure to vibration. Such symptoms include numbness, loss of feeling, tingling, pricking, pain, loss of strength, changes in skin color or condition. These symptoms normally appear in the fingers, hands or wrists. The risk increases at low temperatures.

### Muffler



The muffler is designed to reduce the noise level and to direct the exhaust gases away from the operator.

**CAUTION!** Muffler is fitted with a catalytic converter designed to reduce harmful exhaust gases.

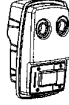

In countries that have a warm and dry climate there is a significant risk of fire. We therefore fit certain mufflers with a spark arrestor mesh. Check whether the muffler on your machine is fitted with this kind of mesh.

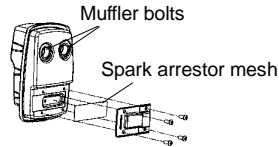

For mufflers, it is very important that you follow the instructions on checking, maintaining, and servicing your machine. Never use a machine that has a faulty muffler.

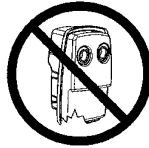

Regularly check that the muffler is securely attached to the machine.

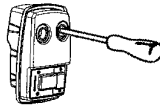

**WARNING:** Mufflers fitted with catalytic converters get very hot during use and remain so for some time after stopping. This also applies at idle speed. Contact can result in burns to the skin. Remember the risk of fire!

**WARNING:** The inside of the muffler contain chemicals that may be carcinogenic. Avoid contact with these elements in the event of a damaged muffler.

## GENERAL SAFETY PRECAUTIONS



**WARNING:** Bear in mind that: Engine exhaust fumes contain carbon monoxide, which can cause carbon monoxide poisoning. For this reason you should not start or run the machine indoors, or anywhere that is poorly ventilated. The exhaust fumes from the engine are hot and may contain sparks which can start a fire. Never start the machine indoors or near combustible material!

### Locking nut

A locking nut is used to secure some types of cutting attachment.

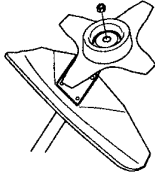

When fitting, tighten the nut in the opposite direction to the direction of rotation of the cutting attachment. To remove it, undo the nut in the same direction as the cutting attachment rotates. (**CAUTION!** The nut has a left-hand thread.) Tighten the nut using the socket spanner.

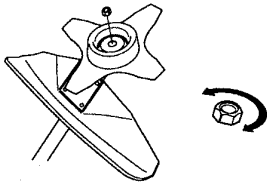

The nylon lining inside the locking nut must not be so worn that you can turn it by hand. The lining should offer a resistance of at least 1.5 Nm. The nut should be replaced after it has been put on approx. 10 times.

### Cutting equipment

This section describes how to choose and maintain your cutting equipment in order to:

- Reduce the risk of blade thrust.
- Obtain maximum cutting performance.
- Extend the life of cutting equipment.

### IMPORTANT!

Only use cutting attachments with the guards we recommend! See the section on "Technical data". Refer to the instructions for the cutting attachment to check the correct way to load the trimmer line and the correct line diameter. Keep the teeth of the blade correctly sharpened! Follow our recommendations. Also refer to the instructions on the blade packaging. Maintain the correct blade setting! Follow our instructions and use the recommended file gauge.



**WARNING:** Always stop the engine before doing any work on the cutting attachment. This continues to rotate even after the throttle has been released. Ensure that the cutting attachment has stopped completely and disconnect the lead from the spark plug before you start to work on it.



**WARNING:** Using an incorrect cutting attachment or an incorrectly sharpened blade increases the risk of kickback.

### Cutting equipment

Grass blades and grass cutters are intended for cutting coarse grass.



A trimmer head is intended for trimming grass.

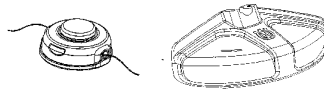

### General rules



Only use cutting attachments with the guards we recommend! See the section on Technical data.



Keep the teeth of the blade correctly sharpened! Follow our instructions and use the recommended file gauge. An incorrectly sharpened or damaged blade increases the risk of accidents.



## GENERAL SAFETY PRECAUTIONS

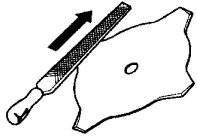

Check the cutting attachment for damage or cracks. A damaged cutting attachment should always be replaced.



### Sharpening grass cutters and grass blades



- See the cutting attachment packaging for correct sharpening instructions. Sharpen blades and cutters using a single-cut flat file.
- Sharpen all edges equally to maintain the balance of the blade.

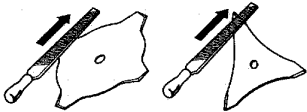

**WARNING:** Always discard a blade that is bent, twisted, cracked, broken or damaged in any other way. Never attempt to straighten a twisted blade so that it can be re-used. Only use original blades of the specified type.

### Trimmer head

#### IMPORTANT!

Always ensure the trimmer line is wound tightly and evenly around the drum, otherwise the machine will generate harmful vibration.

- Only use the recommended cutting attachments. See the section on "Technical data".



- Smaller machines generally require small trimmer heads and vice versa. This is because when clearing using trimmer line the engine must throw out the trimmer line radially from the trimmer head and overcome the resistance of the grass being cleared.
- The length of the trimmer line is also important. A longer trimmer line requires greater engine power than a shorter trimmer line of the same diameter.
- Make sure that the cutter on the trimmer guard is intact. This is used to cut the trimmer line to the correct length.
- To increase the life of the trimmer line it can be soaked in water for a couple of days. This will make the line tougher so that it lasts longer.

## ASSEMBLY

**NOTE:** Make sure unit is assembled correctly as shown in this manual.

### Fitting the loop handle

- Position the handle on the shaft. Note that the handle must be mounted between the two arrows on the shaft.

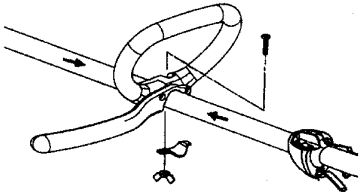

- Fit the screw, securing plate and wing nut as shown in the diagram.

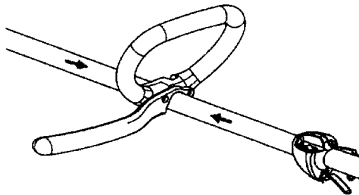

- Make a final adjustment of the J-handle to a comfortable working position. Tighten the wing nut.

**WARNING:** Only grass blades/grass cutters or trimmer heads/plastic blades may be used when the J-handle is fitted. Saw blades must never be used with the J-handle.

### Fitting the harness



**WARNING:** When using a brushcutter, it must always be hooked securely to the harness. Otherwise, you will be unable to control the brushcutter safely. This can result in injury to yourself or others.

Proper harness and handlebar adjustments must be made with the engine completely stopped before using unit.

### Fitting the harness clamp

- Place the upper harness clamp over the shaft and position the lower harness clamp under the shaft. Align the upper and lower clamp screw holes. Clamp must be fitted above the arrow on the shaft (see illustration).

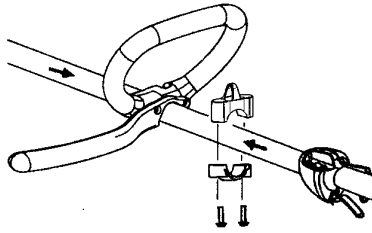

- Insert two screws into the screw holes.
- Secure harness clamp by tightening screws with a hex wrench.

### Adjusting the harness

- Insert your right arm and head through the harness and allow it to rest on your left shoulder. Make sure the harness hook is to the right side of your waist.

**NOTE:** A one-half twist is built in the harness to allow the harness to rest flat on the shoulder.

- Adjust the harness, allowing the hook to be about 15 cm below the waist.
- Fasten the harness to the harness clamp on the shaft and lift the unit to the operating position.
- Put on the harness. Now make a final adjustment so that the unit is in a comfortable working position when it hangs from the harness.

**NOTE:** It may be necessary to relocate the harness clamp on the shaft for proper balancing of unit.



### Correct height

Adjust the harness so that the cutting attachment is parallel to the ground.



## ASSEMBLY

### Correct balance

Let the cutting attachment rest lightly on the ground. If you use a grass blade, it should balance about 10 cm above the ground to prevent contact with stones and the like. Adjust the position of the harness clamp to balance the unit correctly.



### Fitting blades and trimmer heads

- When fitting the cutting attachment it is extremely important that the raised section on the drive disc/support flange engages correctly in the centre hole of the cutting attachment. If the cutting attachment is fitted incorrectly it can result in serious and/or fatal personal injury.

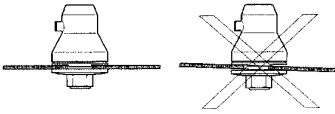

**WARNING:** Never use a cutting attachment without an approved guard. See the section on Technical data. If an incorrect or faulty guard is fitted this can cause serious personal injury.

### Fitting a blade guard, grass blade and grass cutter

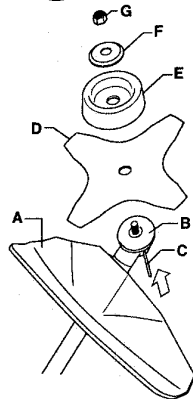

- Hook the blade guard/combination guard (A) onto the fitting on the shaft and secure with the bolt.
- CAUTION!** Use the recommended blade guard. See the Technical data section.
- Fit the drive disc (B) on the output shaft.
- Turn the blade shaft until one of the holes in the drive disc aligns with the corresponding hole in the gear housing.
- Insert the locking pin (C) in the hole to lock the shaft.
- Place the blade (D), support cup (E) and support flange (F) on the output shaft.
- Fit the nut (G). The nut must be tightened to a torque of 35-50 Nm (3.5-5 kpm). Use the socket spanner in the tool kit. Hold the shaft of the spanner as close to the blade guard as possible. To tighten the nut, turn the spanner in the opposite direction to the direction of rotation (**CAUTION!** left-hand thread).

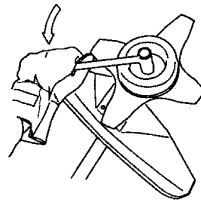

## ASSEMBLY

### Fitting the trimmer guard and trimmer head



- Fit the correct trimmer guard (A) for use with the trimmer head. Hook the trimmer guard/combination guard onto the fitting on the shaft and secure with the bolt (D).

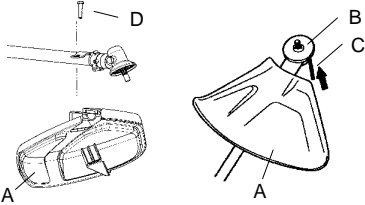

- Fit the drive disc (B) on the output shaft.
- Turn the shaft until one of the holes in the drive disc aligns with the corresponding hole in the gear housing.
- Insert the locking pin (C) in the hole to lock the shaft.
- Screw on the trimmer head (H) in the opposite direction to the direction of rotation.

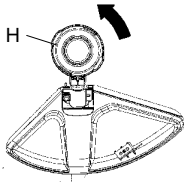

- To dismantle, follow the instructions in the reverse order.

# FUEL HANDLING

## Fuel safety

Never start the machine:

1. If you have spilled fuel on it. Wipe off the spillage and allow remaining fuel to evaporate.
2. If you have spilled fuel on yourself or your clothes, change your clothes. Wash any part of your body that has come in contact with fuel. Use soap and water.
3. If the machine is leaking fuel. Check regularly for leaks from the fuel cap and fuel lines.

## Transport and storage

- Store and transport the machine and fuel so that there is no risk of any leakage or fumes coming into contact with sparks or naked flames, for example, from electrical machinery, electric motors, electrical relays/switches or boilers.
- When storing and transporting fuel always use approved containers intended for this purpose.
- When storing the machine for long periods the fuel tank must be emptied. Contact your local petrol station to find out where to dispose of excess fuel.
- Ensure the machine is cleaned and that a complete service is carried out before long-term storage.
- The transport guard must always be fitted to the cutting attachment when the machine is being transported or in storage.
- In order to prevent unintentional starting of the engine, the spark plug cap must always be removed during long-term storage, if the machine is not under close supervision and when performing all service measures.

**WARNING:** Take care when handling fuel. Bear in mind the risk of fire, explosion and inhaling fumes.

## Fuel

**CAUTION!** The machine is equipped with a two-stroke engine and must always be run using a mixture of petrol and two-stroke engine oil. It is important to accurately measure the amount of oil to be mixed to ensure that the correct mixture is obtained. When mixing small amounts of fuel, even small inaccuracies can drastically affect the ratio of the mixture.

**WARNING:** Fuel and fuel fumes are highly inflammable and can cause serious injury when inhaled or allowed to come in contact with the skin. For this reason observe caution when handling fuel and make sure there is adequate ventilation.

## Petrol



**CAUTION!** Always use a good quality petrol/oil mixture (at least 90 octane). Use low-emission petrol, also known as alkylate petrol, if it is available.

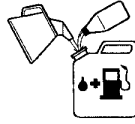

- The lowest octane recommended is 90. If you run the engine on a lower octane than 90, it can result in knocking. This gives rise to a high engine temperature, which can result in serious engine damage.
- When working at continuous high revs, a higher octane rating is recommended.

## Two-stroke oil

- For best results and performance, use HUSQVARNA two-stroke oil, which is specially formulated for our two-stroke engines. Mixture 1:50 (2%).
- If HUSQVARNA two-stroke oil is not available, you may use another two-stroke oil of good quality that is intended for air cooled engines. Contact your dealer when selecting an oil. Mixing ratio 1:33 (3%).
- Never use two-stroke oil intended for water-cooled outboard engines, sometimes referred to as outboard oil.
- Never use oil intended for four-stroke engines.

Petrol, litre	Two-stroke oil, litre	
	2% (1:50)	3% (1:33)
5	0,10	0,15
10	0,20	0,30
15	0,30	0,45
20	0,40	0,60

## FUEL HANDLING

### Mixing

- Always mix the petrol and oil in a clean container intended for fuel.
- Always start by filling half the amount of the petrol to be used. Then add the entire amount of oil. Mix (shake) the fuel mixture. Add the remaining amount of petrol.
- Mix (shake) the fuel mixture thoroughly before filling the machine's fuel tank.

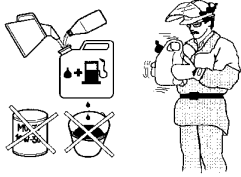

- Do not mix more than one month's supply of fuel at a time.
- If the machine is not used for some time, the fuel tank should be emptied and cleaned.

**WARNING:** The catalytic converter muffler gets very hot during and after use. This also applies during idling. Be aware of the fire hazard, especially when working near flammable substances and/or vapors.

### Fuelling



**WARNING:** Taking the following precautions, will lessen the risk of fire:

- Do not smoke or place hot objects near fuel.
- Always shut off the engine before refueling.
- Always stop the engine and let it cool for a few minutes before refuelling.
- When refueling, open the fuel cap slowly so that any excess pressure is released gently.
- Tighten the fuel cap carefully after refueling.
- Always move the machine away from the refueling area before starting.

- Clean the area around the fuel cap. Contamination in the tank can cause operating problems.
- Ensure that the fuel is well mixed by shaking the container before filling the tank.

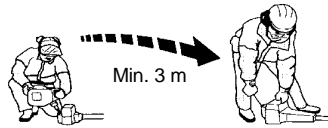

## STARTING AND STOPPING

### Check before starting

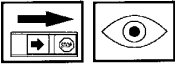

- Check the blade to ensure that no cracks have formed at the bottom of the teeth or by the centre hole. The most common reason why cracks are formed is that sharp corners have been formed at the bottom of the teeth while sharpening or that the blade has been used with dull teeth. Discard a blade if cracks are found.



- Check that the support flange is not cracked due to fatigue or due to being tightened too much. Discard the support flange if it is cracked.

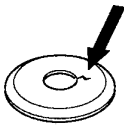

- Ensure the locking nut has not lost its captive force. The nut lock should have a locking force of at least 1.5 Nm. The tightening torque of the locking nut should be 35-50 Nm.

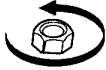

- Check that the trimmer head and trimmer guard are not damaged or cracked. Replace the trimmer head or trimmer guard if they have been exposed to impact or are cracked.

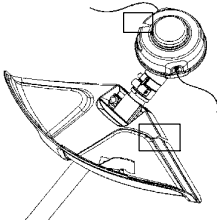

- Never use the machine without a guard nor with a defective guard.
- All covers must be correctly fitted and undamaged before you start the machine.

### Starting and stopping



**WARNING:** The complete clutch, clutch cover, and shaft must be fitted before the machine is started, otherwise parts could come loose and cause personal injury. Always move the machine away from the refueling area before starting. Place the machine on a flat surface. Ensure the cutting attachment cannot come into contact with any object. Make sure no unauthorized persons are in the working area, otherwise there is a risk of serious personal injury. The safety distance is 15 meters.

#### Cold engine

**Primer bulb:** Press the primer bulb 10 times until fuel begins to fill the bulb. The primer bulb need not be completely filled.

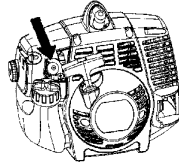

**Choke:** Move the blue engine choke lever over to the closed position.

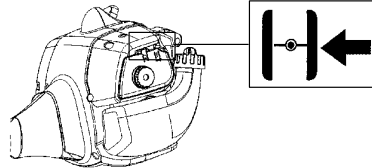

#### Starting

Hold the body of the machine on the ground using your left hand (**CAUTION!** Not with your foot!).

Firmly grip the starter rope handle with your right hand. **DO NOT squeeze throttle trigger.** Slowly pull out the cord until you feel some resistance (the starter pawls grip); then quickly and powerfully pull the cord.

**Never wrap the starter cord around your hand.**

Repeat pulling the cord until the engine attempts to start. Move the blue engine choke lever to the  $\frac{1}{2}$  position. Pull starter rope until engine runs. Move the blue engine choke lever to the opened position.

## STARTING AND STOPPING

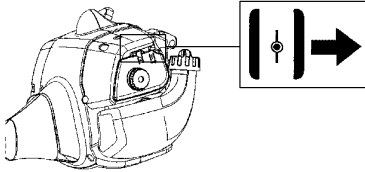

**NOTE:** If engine dies, return blue engine choke lever to the closed position and repeat starting steps.

**CAUTION!** Do not pull the starter cord all the way out and do not let go of the starter handle when the cord is fully extended. This can damage the machine.

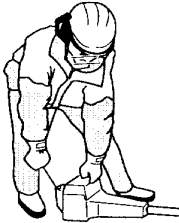

### Warm engine

With a warm engine, Move the blue engine choke lever to the  $\frac{1}{2}$  position. Pull starter rope until engine runs. Move the blue engine choke lever to the opened position.

### CAUTION!

Do not put any part of your body in marked area. Contact can result in burns to the skin, or electrical shock if the spark plug cap has been damaged. Always use gloves. Do not use a machine with damaged spark plug cap.

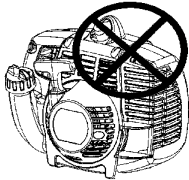

### Stopping

Stop the engine by pushing and holding the stop switch in the STOP position until the engine stops.

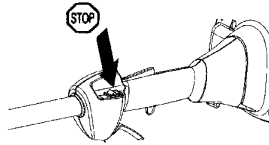

**CAUTION!** The stop switch automatically returns to the start position. In order to prevent unintentional starting, the spark plug cap must be removed from the spark plug when assembling, checking and/or performing maintenance.



**WARNING:** When the engine is started with the choke in the closed position the cutting attachment will start to rotate immediately.



# WORKING TECHNIQUES

## General working instructions

### IMPORTANT!

This section describes the basic safety precautions for working with trimmers. If you encounter a situation where you are uncertain how to proceed you should ask an expert. Contact your servicing dealer. Avoid all usage which you consider to be beyond your capability. You must understand the difference between forestry clearing, grass clearing and grass trimming before use.

### Basic safety rules



1. Look around you:
  - To ensure that people, animals or other things cannot affect your control of the machine.
  - To ensure that people, animals, etc., do not come into contact with the cutting attachment or loose objects that are thrown out by the cutting attachment.
  - **CAUTION!** Do not use the machine unless you are able to call for help in the event of an accident.
2. Do not use the machine in bad weather, such as dense fog, heavy rain, strong wind, intense cold, etc. Working in bad weather is tiring and often brings added risks, such as icy ground, unpredictable felling direction, etc.
3. Make sure you can move and stand safely. Check the area around you for possible obstacles (roots, rocks, branches, ditches, etc.) in case you have to move suddenly. Take great care when working on sloping ground.



4. Switch off the engine before moving to another area. Fit the transport guard before carrying or transporting the equipment any distance.
5. Never put the machine down with the engine running or while the cutting attachment is rotating.

## The ABC of clearing

- Always use the correct equipment.
- Make sure the equipment is well adjusted.
- Follow the safety precautions.
- Organise your work carefully.
- Always use full throttle when starting to cut with the blade.
- Always use sharp blades.
- Avoid stones.

**WARNING:** Neither the operator of the machine nor anyone else may attempt to remove the cut material while the engine is running or the cutting equipment is rotating, as this can result in serious injury. Stop the engine and cutting equipment before you remove material that has wound around the blade shaft as otherwise there is a risk of injury. The bevel gear can get hot during use and may remain so for a while afterwards. You could get burned if you touch it.

**WARNING:** Watch out for thrown objects. Always wear approved eye protection. Never lean over the cutting attachment guard. Stones, rubbish, etc. can be thrown up into the eyes causing blindness or serious injury. Keep unauthorised persons at a distance. Children, animals, onlookers and helpers should be kept outside the safety zone of 15 m. Stop the machine immediately if anyone approaches. Never swing the machine around without first checking behind you to make sure no one is within the safety zone.

**WARNING:** Sometimes branches or grass get caught between the guard and cutting attachment. Always stop the engine before cleaning.

## Basic working techniques

- Always slow the engine to idle speed after each working operation. Long periods at full throttle without any load on the engine can lead to serious engine damage.

## WORKING TECHNIQUES

### Grass clearing using a grass blade



- Grass blades and grass cutters must not be used on woody stems.
- A grass blade is used for all types of tall or coarse grass.
- The grass is cut down with a sideways, swinging movement, where the movement from right-to-left is the clearing stroke and the movement from left-to-right is the return stroke. Let the left-hand side of the blade (between 8 and 12 o'clock) do the cutting.

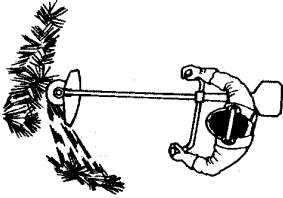

- If the blade is angled to the left when clearing grass, the grass will collect in a line, which makes it easier to collect, e.g. by raking.
- Try to work rhythmically. Stand firmly with your feet apart. Move forward after the return stroke and stand firmly again.
- Let the support cup rest lightly against the ground. It is used to protect the blade from hitting the ground.
- Reduce the risk of material wrapping around the blade by following these instructions:
  - Always work at full throttle.
  - Avoid the previously cut material during the return stroke.
- Stop the engine, unclip the harness and place the machine on the ground before you start to collect the cut material.

### Grass trimming with a trimmer head Trimming



- Hold the trimmer head just above the ground at an angle. It is the end of the trimmer line that does the work. Let the trimmer line work at its own pace. Never press the trimmer line into the area to be cut.

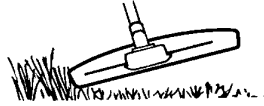

- The trimmer line can easily remove grass and weeds up against walls, fences, trees and borders, however it can also damage sensitive bark on trees and bushes, and damage fence posts.
- Reduce the risk of damaging plants by shortening the trimmer line to 10-12 cm and reducing the engine speed.
- When trimming you should use less than full throttle so that the trimmer line lasts longer and to reduce the wear on the trimmer head.

### Clearing



- The clearing technique removes all unwanted vegetation. Keep the trimmer head just above the ground and tilt it. Let the end of the trimmer line strike the ground around trees, posts, statues and the like. **CAUTION!** This technique increases the wear on the trimmer line.

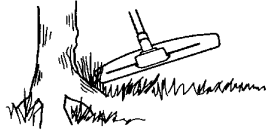

- The trimmer line wears quicker and must be fed forward more often when working against stones, brick, concrete, metal fences, etc., than when coming into contact with trees and wooden fences.

## WORKING TECHNIQUES

### Cutting



- The trimmer is ideal for cutting grass that is difficult to reach using a normal lawn mower. Keep the trimmer line parallel to the ground when cutting. Avoid pressing the trimmer head against the ground as this can ruin the lawn and damage the tool.

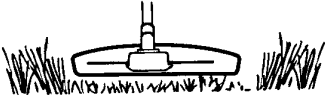

- Do not allow the trimmer head to constantly come into contact with the ground during normal cutting. Constant contact of this type can cause damage and wear to the trimmer head.

### Sweeping



- The fan effect of the rotating line can be used for quick and easy clearing up. Hold the trimmer line parallel to and above the area to be swept and move the tool to and fro.

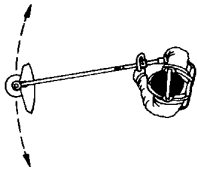

- When cutting and sweeping you should use full throttle to obtain the best results.



**WARNING:** Neither the operator of the machine nor anyone else may attempt to remove the cut material while the engine is running or the trimmer line is rotating, as this can result in serious injury. Stop the engine and trimmer head before you remove material that has wound around the drive shaft as otherwise there is a risk of injury. The bevel gear can get hot during use and may remain so for a while afterwards. You could get burned if you touch it.



**WARNING:** Watch out for thrown objects. Always wear eye protection. Never lean over the cutting attachment guard. Stones, rubbish, etc. can be thrown up into the eyes causing blindness or serious injury. Keep unauthorized persons at a distance. Children, animals, onlookers and helpers should be kept outside the safety zone of 15 m. Stop the machine immediately if anyone approaches.

## MAINTENANCE

The owner is responsible for the performance of all required maintenance as defined in the operator's manual.

### Carburetor

Your Husqvarna product has been designed and manufactured to specifications that reduce harmful emissions. After the engine has used 8-10 tanks of fuel, the engine will be run-in. To ensure that it continues to run at peak performance and to minimize harmful exhaust emissions after the run-in period, ask your servicing dealer to adjust your carburetor.

**WARNING:** The complete clutch, clutch cover, and shaft must be fitted before the machine is started, otherwise parts could come loose and cause personal injury.

### Function



- The carburetor governs the engine's speed via the throttle control. Air and fuel are mixed in the carburetor.
- The T-screw regulates the throttle setting at idle speed. If the T-screw is turned clockwise this gives a higher idle speed; turning it counterclockwise gives a lower idle speed.

### Basic setting

- The basic carburetor settings are adjusted during testing at the factory. Fine adjustment should be carried out by a skilled technician.

**CAUTION!** If the cutting attachment rotates when the engine is idling the idle adjustment screw T should be turned counterclockwise until the cutting attachment stops.

### Rec. idle speed:

See "Technical data" section.

### Recommended max. speed:

See "Technical data" section.

### Fine adjustment of the idle speed-T

Adjust the idle speed using the idle adjustment screw-T if it is necessary to readjust. First, turn the idle adjustment screw-T clockwise until the cutting attachment starts to rotate. Then, turn the screw counterclockwise until the cutting attachment stops. The idle speed is correctly adjusted when the engine will run smoothly in every position. The idle speed should also be well below the speed at which the cutting attachment starts to rotate.

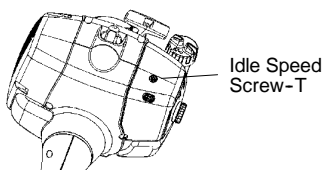

Idle Speed Screw-T

**WARNING:** If the idle speed cannot be adjusted so that the cutting attachment stops, contact your servicing dealer. Do not use the machine until it has been correctly adjusted or repaired.

### Unit/Maintenance Safety

Disconnect the spark plug before performing maintenance, except carburetor adjustments.

### Muffler



**CAUTION!** Muffler is fitted with a catalytic convertic designed to reduce harmful exhaust gases.

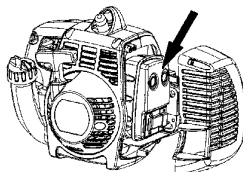

The muffler is designed to reduce the noise level and to direct the exhaust gases away from the operator. The exhaust gases are hot and can contain sparks, which may cause fire if directed against dry and combustible material.

Mufflers are equipped with a special spark arrestor mesh. You should clean the mesh at least once a month. This is best done with a wire brush. **If the mesh is damaged it should be replaced.** If the mesh is frequently blocked, this can be a sign that the performance of the catalytic converter is impaired. Contact your dealer to inspect the muffler. A blocked mesh will cause the machine to overheat and result in damage to the cylinder and piston.

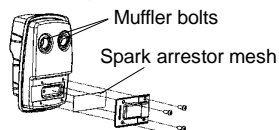

**CAUTION!** Never use a machine that has a faulty or loose muffler. Ensure the muffler bolts are tight.

## MAINTENANCE

**WARNING:** Mufflers fitted with catalytic converters get very hot during use and remain so for some time after stopping. This also applies at idle speed. Contact can result in burns to the skin. Remember the risk of fire!

**WARNING:** The inside of the muffler contain chemicals that may be carcinogenic. Avoid contact with these elements in the event of a damaged muffler.

**WARNING:** Bear in mind that: Engine exhaust fumes contain carbon monoxide, which can cause carbon monoxide poisoning. For this reason you should not start or run the machine indoors, or anywhere that is poorly ventilated. The exhaust fumes from the engine are hot and may contain sparks which can start a fire. Never start the machine indoors or near combustible material!

### Spark plug



The spark plug condition is influenced by:

- Incorrect carburetor adjustment.
- An incorrect fuel mixture (too much or incorrect type of oil).
- A dirty air filter.

These factors cause deposits on the spark plug electrodes, which may result in operating problems and starting difficulties. If the machine is low on power, difficult to start or runs poorly at idle speed: always check the spark plug first before taking any further action. If the spark plug is dirty, clean it and check that the electrode gap is 0,6 mm. The spark plug should be replaced after about a month in operation or earlier if necessary.

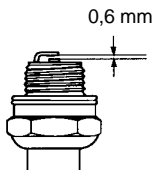

**CAUTION!** Always use the recommended spark plug type! Use of the wrong spark plug can damage the piston/cylinder.

### Air filter

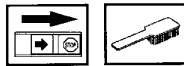

The air filter must be regularly cleaned to remove dust and dirt in order to avoid:

- Carburetor malfunctions
- Starting problems
- Loss of engine power
- Unnecessary wear to engine parts
- Excessive fuel consumption

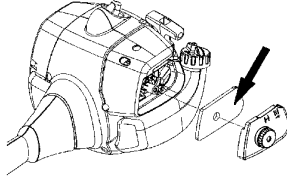

Clean the filter every 25 hours, or more regularly if conditions are exceptionally dusty.

#### Cleaning the air filter

Remove the air filter cover and take out the filter. Wash it clean in warm, soapy water. Rinse thoroughly. Ensure that the filter is dry before refitting it.

An air filter that has been in use for a long time cannot be cleaned completely. The filter must therefore be replaced with a new one at regular intervals. **A damaged air filter must always be replaced.**

### Bevel gear



The bevel gear is filled with the right quantity of grease at the factory. However, before using the machine you should check that the bevel gear is filled three-quarters full with grease. Use HUSQVARNA special grease.

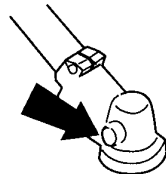

The grease in the bevel gear does not normally need to be changed except if repairs are carried out.

## MAINTENANCE

### Sharpening grass cutters and grass blades



**WARNING:** Always stop the engine before doing any work on the cutting attachment. This continues to rotate even after the throttle has been released. Ensure that the cutting attachment has stopped completely and disconnect the HT lead from the spark plug before you start to work on it.

- See the cutting attachment packaging for correct sharpening instructions.
- Sharpen blades and cutters using a single-cut flat file.
- Sharpen all edges equally to maintain the balance of the blade.

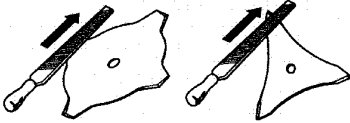

**WARNING:** Always discard a blade that is bent, twisted, cracked, broken or damaged in any other way. Never attempt to straighten a twisted blade so that it can be re-used. Only use original blades of the specified type.

## MAINTENANCE

### Maintenance schedule

The following is a list of the maintenance that must be performed on the machine. Most of the items are described in the Maintenance section. The user must only carry out the maintenance and service work described in this Operator's Manual. More extensive work must be carried out by an authorised service workshop.

Maintenance	Daily Maintenance	Weekly Maintenance	Monthly Maintenance
Clean the outside of the machine.	X		
Make sure the throttle trigger lock and the throttle function correctly from a safety point of view.	X		
Check that the stop switch works correctly.	X		
Check that the cutting attachment does not rotate at idle.	X		
Clean the air filter. Replace if necessary.	X		
Check that the guard is undamaged and not cracked. Replace the guard if it has been exposed to impact or is cracked.	X		
Check that the trimmer head is undamaged and not cracked. Replace the trimmer head if necessary.	X		
Check that the locking nut of the cutting equipment is tightened correctly.	X		
Check that nuts and screws are tight.	X		
Check that there are no fuel leaks from the engine, tank or fuel lines.	X		
Check the starter and starter cord.		X	
Clean the outside of the spark plug. Remove it and check the electrode gap. Adjust the gap to 0,6 mm or replace the spark plug. Check that the spark plug is fitted with a suppressor.		X	
Clean the outside of the carburetor and the space around it.		X	
Check that the bevel gear is filled three-quarters full with lubricant. Fill if necessary using special grease.		X	
Check the fuel filter from contamination and the fuel hose from cracks or other defects. Replace if necessary.			X
Check all cables and connections.			X
Check the clutch, clutch springs and the clutch drum for wear. Replace if necessary by an authorized service workshop.			X
Replace the spark plug. Check that the spark plug is fitted with a suppressor.			X
Clean or replace the spark arrestor mesh on the muffler.			X

## TECHNICAL DATA

### Technical data

#### 128RJ

#### Engine

Cylinder displacement, cm <sup>3</sup>	28
Cylinder bore, mm	35
Stroke, mm	28,7
Idle speed, rpm	2800-3200
Recommended max. fast idle speed, rpm	11000
Speed of output shaft, rpm	8000
Max. engine output, acc. to ISO 8893, kW	0,8
Catalytic converter muffler	Yes
Speed-regulated ignition system	Yes

#### Ignition system

Manufacturer/type of ignition system	Walbro/CD
Spark plug	Champion RCJ-8Y
Electrode gap, mm	0,6

#### Fuel and lubrication system

Manufacturer/type of carburetor	Zama
Zama	
Fuel tank capacity, litre	0,4

#### Weight

Weight without fuel, cutting attachment and guard, kg	4,8
---	-----

#### Noise emissions

(see note 1)

Sound power level, measured dB(A)	109
Sound power level, guaranteed L <sub>WA</sub> dB(A)	114

#### Noise levels

(see note 2)

Equivalent noise pressure level at the operators' ear, measured according to EN/ISO 11806 and ISO 22868, dB(A)	100
--	-----

#### Vibration levels

Vibration levels at handles, measured according to EN/ISO 11806 and ISO 22867

##### FRONT HANDLE

Idling, m/s <sup>2</sup>	3,9
Racing, m/s <sup>2</sup>	5,6

##### REAR HANDLE

Idling, m/s <sup>2</sup>	2,9
Racing, m/s <sup>2</sup>	8,5

**Note 1:** Noise emissions in the environment measured as sound power (L<sub>WA</sub>) in conformity with EC directive 2000/14/EC.

**Note 2:** Equivalent sound pressure level is calculated as the time-weighted energy total for sound pressure levels under various working conditions with the following time distribution: 1/2 idling and 1/2 max speed.

**NOTE!** The noise pressure level at operator's ear and vibrations on the handles are measured with all the approved cutting attachments for the machine. The table indicates the lowest and highest values.

Model 128RJ (M10 LH arbor shaft thread) - Centre hole in blades/cutters, Ø 25,4 mm		
Approved accessories	Type	Cutting attachment guard, part. no.
Grass blade/grass cutter	Grass 255-4 1 inch (Ø 250 4-teeth)	503 93 42-02
Trimmer head	T25	537 33 83-02
Plastic blades	Tricut 300 mm	531 00 38-11
Support cup	Fixed	-



---

## DECLARATION OF CONFORMITY

---

### EC Declaration of Conformity (Only applies to Europe)

We, **Husqvarna AB**, SE-561 82 Huskvarna, Sweden, Tel: +46-36-146000, as authorised representative in the Community, declare that the brushcutter model **Husqvarna 128RJ** from serial numbers 2009-031N00001 and onwards (the year is clearly stated on the rating plate, followed by the serial number), comply with the requirements of the **COUNCIL'S DIRECTIVES**:

of 22 June 1998 "relating to machinery" **98/37/EC**, annex IIA;

of 15 December 2004 "relating to electromagnetic compatibility" **2004/108/EC**, and applicable supplements; and

of 8 May 2000 "relating to the noise emissions in the environment" in accordance with Annex V of **2000/14/EC**. The measured sound power is 109 dB(A), the guaranteed sound power is 114 dB(A). The cutting width is 43 cm.

The following standards have been applied: **EN12100-1:2003**, **EN 12100-2:2003**, **EN ISO 11806:1997** and **CISPR 12:2005**.

**SMP, The Swedish Machinery Testing Institute**, Fyrisborgsgatan 3 S-754 50 Uppsala, Sweden, has carried out voluntary type approval. The certificate(s) are numbered: **SEC/06/1099**.

09-1-31



Ronnie E. Goldman, Director of Engineering  
Handheld Consumer Products

# Trimmer Head Line Loading Instructions



<b>1</b> 	<b>2</b> 	<b>3</b> 
<b>4</b> 	<b>5</b> 	
<b>6</b> 	<b>7</b> 	<b>8</b> 
<b>9</b> 		

# Plastic Blades (Tri Cut)

