

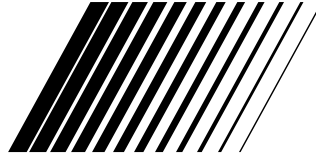

JVC



COMPACT VHS CAMCORDER

GR-AX460
GR-AX360
GR-AX260

ENGLISH

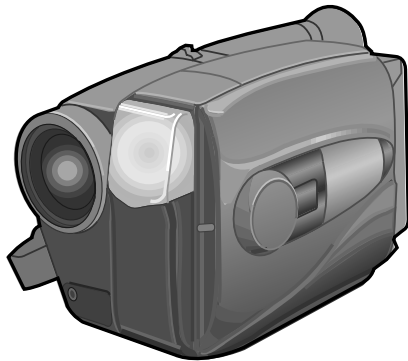

(GR-AX460 shown)

Compact VHS



INSTRUCTIONS

YU30052-562-1





2

Dear Customer,

Thank you for purchasing the JVC Compact VHS camcorder. Before use, please read the safety information and precautions contained in the following pages to ensure safe use of your new camcorder.

Using This Instruction Manual

- All major sections and subsections are listed in the Table Of Contents (☞ pg. 3).
- Notes appear after most subsections. Be sure to read these as well.
- Basic and advanced features/operation are separated for easier reference.

It is recommended that you . . .

- refer to the Index (☞ pgs. 36, 37) and familiarize yourself with button locations, etc. before use.
- read thoroughly the Safety Precautions that follow and cautions (☞ pgs. 38, 39). They contain extremely important information regarding the safe use of your new camcorder.

SAFETY PRECAUTIONS

WARNING:
TO PREVENT FIRE OR SHOCK HAZARD, DO NOT EXPOSE THIS UNIT TO RAIN OR MOISTURE.

CAUTIONS:

- To prevent shock, do not open the cabinet. No user serviceable parts inside. Refer servicing to qualified personnel.
- When you are not using the AC Power Adapter/Battery charger for a long period of time, it is recommended that you disconnect the power cord from AC outlet.



- Camcorder is designed exclusively for the VHS-C video cassette. Only cassettes marked VHS-C can be used with this unit.
- HQ VHS is compatible with existing VHS equipment.

Warning on lithium battery

The battery used in this device may present a fire or chemical burn hazard if mistreated. Do not recharge, disassemble, heat above 100°C or incinerate.

Replace battery with Panasonic (Matsushita Electric), Sanyo or Maxell CR2025; use of another battery may present a risk of fire or explosion.

- Dispose of used battery promptly.
- Keep away from children.
- Do not disassemble and do not dispose of in fire.

Crossed Out Dust Bin Mark

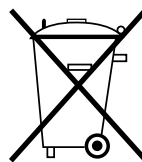

Cd

- The Crossed Out Dust Bin Mark on the battery pack indicates that the product complies with Directives 91/157/EEC and 93/86/EEC.
- Nickel-Cadmium (Ni-Cd) battery pack must be recycled or disposed of properly.

This camcorder is designed to be used with PAL-type colour television signals. It cannot be used for playback with a television of a different standard. However, live recording is possible anywhere. Use the BN-V12U/V22U/V25U battery packs and, to recharge them, the provided multi-voltage AC Power Adapter/Charger. (An appropriate conversion adapter may be necessary to accommodate different designs of AC outlets in different countries.)

NOTES:

- The rating plate (serial number plate) and safety caution are on the bottom and/or the back of the main unit.
- The rating plate (serial number plate) of the AC Power Adapter/Charger is on its bottom.

This unit is produced to comply with Standard IEC Publ. 65.



MAJOR FEATURES

- Programme AE with Special Effects (☞ pg. 14)
- Intelligent Function Control (☞ pg. 16 – 23)
- 14x Variable-Speed Hyper Zoom (☞ pg. 11)
- EasyEdit (Random Assemble Editing) (☞ pg. 30 – 33)
- Design-Integrated Auto Light (GR-AX460 only) (☞ pg. 13)

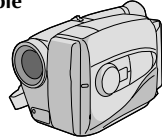

REMEMBER

The Logical Choice

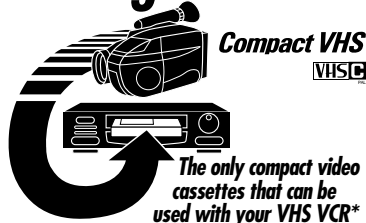

The only compact video cassettes that can be used with your VHS VCR*
*with Cassette Adapter

PROVIDED ACCESSORIES

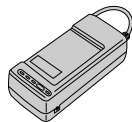

- AC Power Adapter/Charger AA-V11EG



- Battery Pack BN-V12U

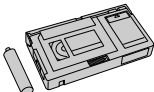

- Cassette Adapter C-P7U

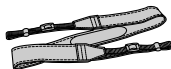

- Shoulder Strap



- Lithium Battery CR2025

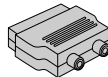

- Cable adapter



- Editing cable

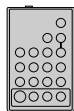

- Remote Control Unit RM-V704U (GR-AX460 only)



- AUDIO/VIDEO (A/V) cable

CONTENTS

3

GETTING STARTED 4

Power	4
Clock (Lithium) Battery Removal/Insertion	6
Date/Time Settings	6
Viewfinder Adjustment	7
Tape Length Setting	7
Loading/Unloading A Cassette	7
Grip Adjustment	8
Shoulder Strap Attachment	8
Tripod Mounting	8
Remote Control Unit	9

RECORDING 10

Basic Recording	10
Basic Features	11
Advanced Features	13

PLAYBACK 26

Using The Cassette Adapter	26
Basic Connections	27
Basic Playback	28
Features	29

EDITING 30

Tape Dubbing	30
Random Assemble Editing (R.A.Edit)	30
Insert Editing	34
Audio Dubbing	35

INDEX 36

Controls	36
Connectors	36
Indicators	36
Other Parts	36
Viewfinder	37

CAUTIONS 38

TROUBLESHOOTING 40

SPECIFICATIONS 41

OPTIONAL ACCESSORIES 41



4

GETTING STARTED

Power

This camcorder's 3-way power supply system lets you choose the most appropriate source of power.

NOTES:

- No function is available without power supply.
- Use only specified power supply.
- Do not use provided power supply units with other equipment.

CHARGING THE BATTERY PACK

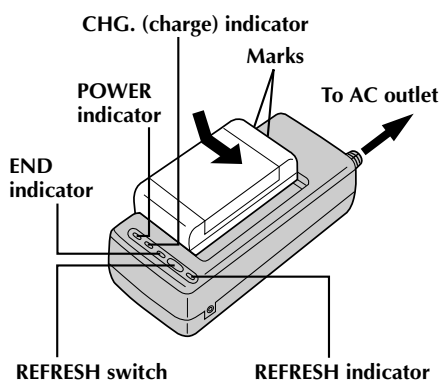

1 SUPPLY POWER

Connect the charger's AC power cord to a wall outlet. The power indicator lights.

2 ATTACH BATTERY PACK

Align the marks and slide the battery pack in the direction of the arrow until it locks in place. The CHG. indicator lights.

3 DETACH BATTERY PACK

When charging is completed, the END indicator lights. Slide the battery pack opposite the direction of the arrow.

BATT. PACK	CHARGE	DISCHARGE
BN-V12U	approx. 1 hr. 10 min.	approx. 3 hrs. 30 min.
BN-V22U	approx. 2 hrs. 10 min.	approx. 7 hrs.
BN-V25U	approx. 2 hrs. 40 min.	approx. 10 hrs.

USING THE BATTERY PACK

1 ATTACH BATTERY PACK

Hook its top end to the camcorder and push the battery pack in until it locks in place.

2 DETACH BATTERY PACK

Slide BATT. RELEASE and pull out the battery pack.

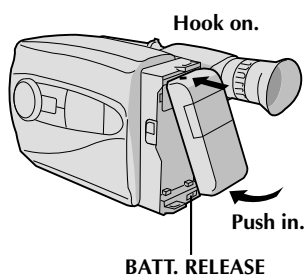

BATT. PACK	APPROXIMATE RECORDING TIME	
	GR-AX460/AX260	GR-AX360
BN-V12U	1 hr. 5 min. (35 min.)	1 hr.
BN-V22U	2 hrs. 15 min. (1 hr. 25 min.)	2 hrs. 10 min.
BN-V25U	3 hrs. (1 hr. 50 min.)	2 hrs. 50 min.

() : when the video light is on (GR-AX460 only).

**REFRESH

The AC power adapter features a REFRESH function that allows you to fully discharge the battery pack before recharging.

To discharge the battery . . .

.... attach the battery pack to the adapter as shown in the illustration to the left. Then push REFRESH. The REFRESH indicator lights when discharging starts, and goes out when discharging is complete.

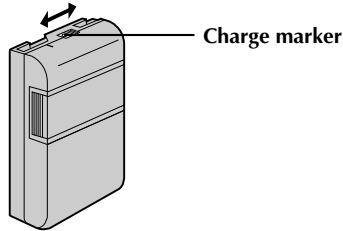

****CHARGE MARKER**

A charge marker is provided on the battery pack to help you remember whether it has been charged or not. Two colours are provided (red and black)—you choose which one means charged and which means discharged.

NOTES:

- The recording time per charge is affected by such factors as the time spent in Record/Standby mode and the frequency of zooming. It is safer to have spare battery packs.
- Charging times noted on page 4 are for fully discharged battery pack, and discharging times are for fully charged battery pack.
- Charging and discharging times vary according to the ambient temperature and the status of the battery pack.
- Remember to set the charge marker after charging a battery pack or after detaching a discharged one from your camcorder.
- Perform the REFRESH function after no less than 5 chargings.
- High temperatures can damage the battery pack, so use only where good ventilation is available. Don't allow it to discharge in container, such as a bag.
- If you stop recharging or discharging partway through, make sure to remove the battery pack before unplugging the adapter's AC cord.
- Remove the battery pack from the adapter immediately after discharging.
- To avoid interference with reception, do not use the AC Power Adapter/Charger near a radio.
- Make sure you unplug the DC cord before charging or discharging the battery pack.
- A blinking CHG. indicator means that the battery pack has become hot. Wait until it cools down to continue.
- The CHG. indicator may not light properly with a brand new battery pack, or with one that's been stored for an extended period. In this case, remove and reattach the battery pack and recharge it. The CHG. indicator should light during recharging. If not, contact your nearest JVC dealer.

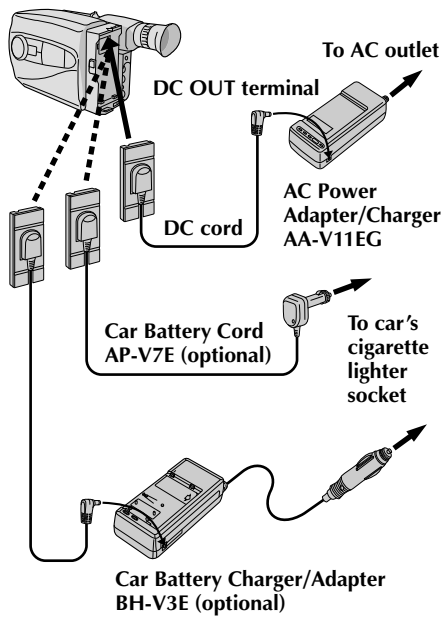

USING A CAR BATTERY

Use the optional Car Battery Cord or Car Battery Charger/Adapter (connect as shown in the illustration to the left).

NOTES:

- When using the car battery, leave the engine idling.
- The optional Car Battery Charger (BH-V3E) can also be used to charge the battery pack.
- When using the optional Car Battery Charger or Car Battery Cord (AP-V7E), refer to the respective instruction booklet.

USING AC POWER

Use the AC Power Adapter (connect as shown in the illustration to the left).

NOTE:

The supplied AC Power Adapter/Charger features automatic voltage selection in the AC range from 110 V to 240 V.



6

GETTING STARTED (cont.)

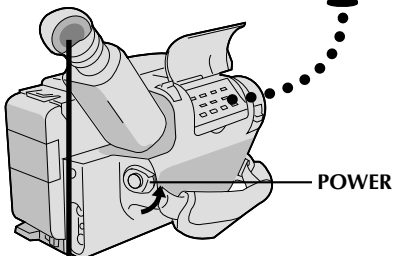
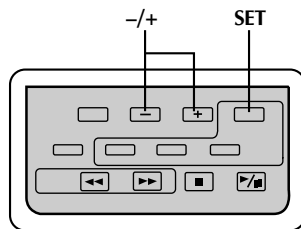
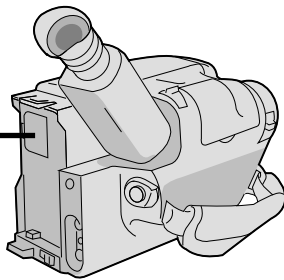
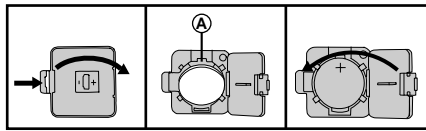

Date
Day/Month/Year
DATE ... Date setting is performed

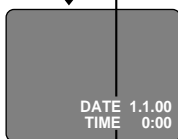

Time
24-hour indication
TIME Time setting is performed

Clock (Lithium) Battery Removal/Insertion

This battery is necessary to operate the clock and to perform date/time settings.

- 1 SWITCH OFF POWER**
Switch off the unit's power and remove the power supply unit.
- 2 OPEN COVER**
Open the clock battery compartment cover while pressing the release tab.
- 3 REMOVE BATTERY (when replacing)**
Insert a pointed, non-metallic object between the battery and the compartment (A) and pull the battery out.
- 4 INSERT BATTERY**
Ensuring the plus (+) side is up, insert the supplied lithium battery and push it in.
- 5 CLOSE COVER**
Close the compartment cover until it clicks in place.

NOTE:

See "SAFETY PRECAUTIONS" (pg. 2) for information on safe handling of lithium batteries.

Date/Time Settings

- 1 SELECT MODE**
Set the power switch to CAMERA.
- 2 SET DATE/TIME**
Press **SET** and the day blinks. Press + or - to set the day. Repeat to set month, year, hour and minute.
- 3 START CLOCK**
Press **SET**. The blinking stops. The date and time are both displayed for confirmation, then the time display disappears.

NOTE:

The clock does not keep time while the date and time are blinking.



TAPE30•45 tape length select button

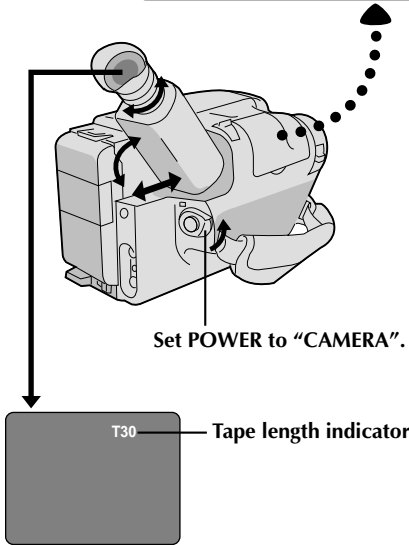
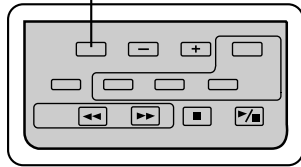

Set POWER to "CAMERA".

T30 — Tape length indicator

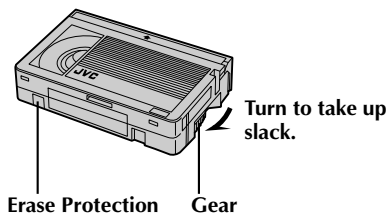
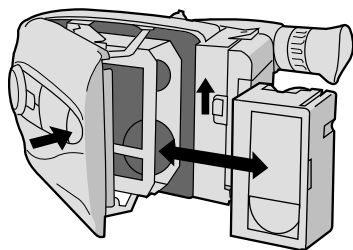

Viewfinder Adjustment

POSITION VIEWFINDER

1 Adjust the viewfinder manually for best viewability (see illustration at left).

SELECT MODE

2 Set the power switch to CAMERA.

ADJUST DIOPTER

3 Turn the diopter adjustment control until the indications in the viewfinder are clearly focused.

Tape Length Setting

SET TAPE LENGTH

1 Set the tape length button according to the length of the tape used. T30 = 30 minutes of recording time and T45 = 45 minutes.

NOTE:

The tape remaining time indicator does not work with tapes other than EC30 and EC45. (See Basic Recording on pg. 10 for "tape remaining time indicator".)

Loading/Unloading A Cassette

OPEN CASSETTE HOLDER

1 Slide EJECT until holder opens. Do not use force to open.

INSERT/REMOVE CASSETTE

2 Make sure label is facing outward.

CLOSE CASSETTE HOLDER

3 Press PUSH and make sure the holder is closed and locked.

NOTES:

- A cassette holder can't be opened unless a power supply is attached.
- Make sure that the tape is not slack when loading the cassette. If there is any slack, turn the gear on the cassette in the direction of the arrow to take up the slack.
- Make sure the Erase Protection tab is present. If not, cover the hole with adhesive tape. (Some cassettes have sliding tabs – in this case, check the tab's position.)



8

GETTING STARTED (cont.)

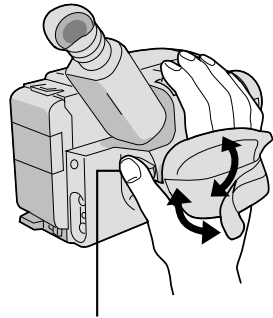

Recording Start/Stop button

Grip Adjustment

EXPAND LOOP

- 1** Separate the Velcro strip.

INSERT HAND

- 2** Pass your right hand through the loop and grasp the grip.

ADJUST STRAP LENGTH

- 3** Adjust so your thumb and fingers can easily operate the Recording Start/Stop button and Power Zoom switch. Refasten the Velcro strip.

Shoulder Strap Attachment

ATTACH STRAP

- 1** Following the illustration at left, thread the strap through the top of the eyelet ①, then fold it back and thread it through the keeper ②, and then through the buckle ③. Repeat the procedure to attach the other end of the strap to the other eyelet, making sure the strap isn't twisted.

ADJUST LENGTH

- 2** Adjust as shown in the illustration at left ①, then slide both keepers snug against the eyelets to prevent slipping ②.

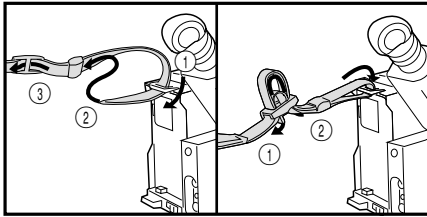

Tripod Mounting

ALIGN AND TIGHTEN

- 1** Align the screw and camera direction stud on the tripod with the camera's mounting socket and stud hole. Then tighten the screw.

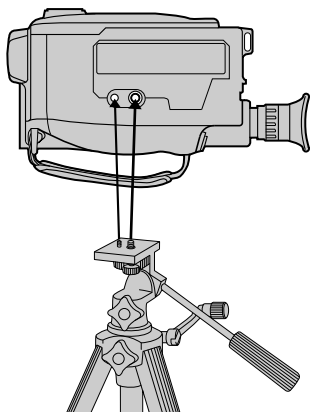

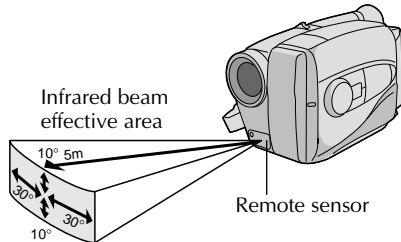

The transmitted beam may not be effective or may cause misoperations when the remote sensor is directly exposed to sunlight or powerful lighting.

Remote Control Unit

The RM-V704U Full-Function Remote Control Unit can operate this camcorder from a distance as well as the basic operations (PLAY, STOP, PAUSE, FF, and REW) of your VCR. This remote control unit makes additional recording functions possible. To operate, point it at the camcorder's remote sensor. The RM-V704U is provided with GR-AX460, and is available optionally for GR-AX360/AX260.

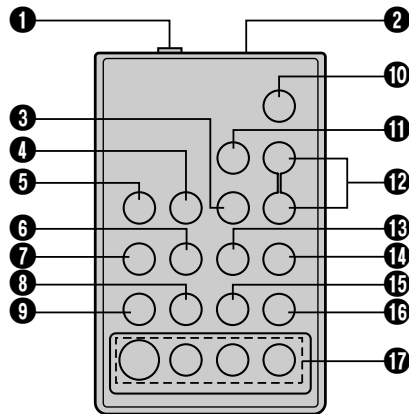

1 PULL OUT BATTERY HOLDER

Pull out the battery holder according to the type of remote control unit you have.

Type Ⓐ: Pull out the battery holder while sliding the lock hole.

Type Ⓑ: Pinch the release tab and pull out the battery holder.

2 INSERT BATTERY

Insert the lithium battery* (CR2025), with its plus (+) side up, into the battery holder.

3 REPLACE BATTERY HOLDER

Replace the battery holder until it clicks in place.
*Read warning on lithium battery. (☞ pg. 2)

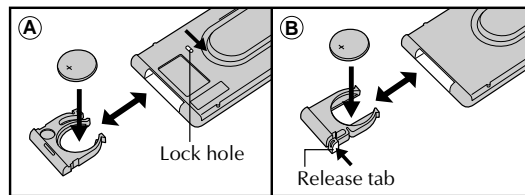

Buttons	Functions	
	With the camcorder's power switch set to "CAMERA".	With the camcorder's power switch set to "PLAY".
① PAUSE IN connector	—	☞ pg. 32
② Infrared beam transmitting window	Transmits the beam signal.	
③ MBR SET button	—	☞ pg. 31
④ INT. TIME button	Self-Timer/Time lapse (☞ pg. 24, 25)	—
⑤ REC TIME button	Animation/Time lapse (☞ pg. 25)	—
⑥ FF button	Retake (Forward) (☞ pg. 11)	FF/FF Shuttle Search (☞ pg. 28)
⑦ REW button	Retake (Rewind) (☞ pg. 11)	Rew/Rew Shuttle Search (☞ pg. 28)
⑧ PAUSE button	—	Pause (☞ pg. 29)
⑨ PLAY button	—	Playback start (☞ pg. 28)
⑩ START/STOP button	Functions same as the Recording Start/Stop button of the camcorder.	
⑪ VISS button	Index code marking (☞ pg. 12)	—
⑫ ZOOM (T/W) button	Zoom (invariable speed) (☞ pg. 11)	—
⑬ VCR CTL button	—	☞ pg. 31
⑭ A. DUB button	—	Audio dubbing (☞ pg. 35)
⑮ STOP button	—	Stop (☞ pg. 28)
⑯ INSERT button	—	Insert Editing (☞ pg. 34)
⑰ R. A. EDIT button	—	☞ pg. 32



10

RECORDING Basic Recording

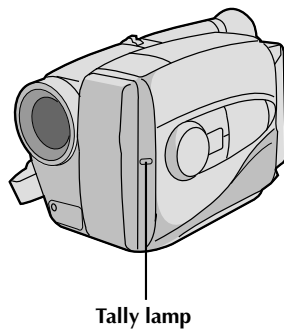
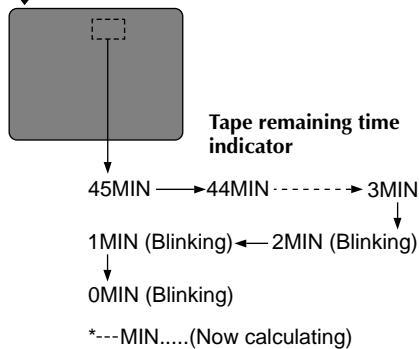
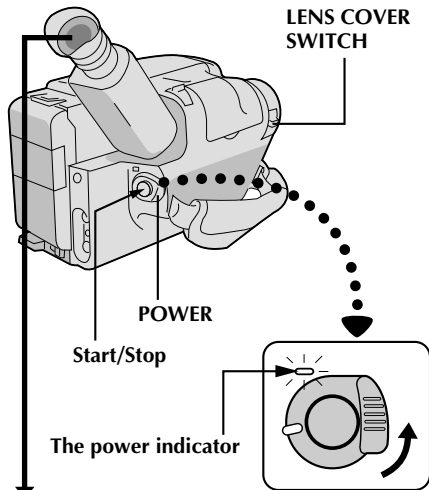

NOTE:

You should already have performed the procedures listed below. If not, do so before continuing.

- Power (☞ pg. 4)
- Tape Length Setting (☞ pg. 7)
- Grip Adjustment (☞ pg. 8)

LOAD A CASSETTE

- 1 Slide EJECT to open the cassette holder, then insert the cassette with the label facing out. Press PUSH to ensure the holder is closed and locked.

ENTER RECORD-STANDBY MODE

- 2 Slide the LENS COVER open/close switch to open the lens cover, then set the power switch to CAMERA.

- The power indicator lights and the camcorder enters the Record-Standby Mode.
- The scene you're aimed at appears on the viewfinder screen, with the word "PAUSE" superimposed upon it.

START SHOOTING

- 3 Press the Recording Start/Stop button.

- The tally lamp lights while recording is in progress, and "REC" appears in the viewfinder.

STOP RECORDING

- 4 Press the Recording Start/Stop button again.

- The camcorder re-enters the Record-Standby mode.

NOTES:

- A cassette holder can't be opened unless a power supply is attached.
- There may be a delay after you slide EJECT until the holder opens. Do not use force.
- The tape's remaining time is displayed in the viewfinder as shown.
- "TAPE END" appears when the tape reaches its end, and the power goes off automatically if left in this condition for 5 minutes. "TAPE END" also appears when a cassette whose tape is already at its end is loaded.
- If the Record-Standby mode continues for 5 minutes, the camcorder's power shuts off automatically. Set the power switch to POWER OFF, and then back to CAMERA to turn the camcorder on again.
- If you're recording on a cassette from the middle, use the RETAKE function (☞ pg. 11) to find the end of the last recording so you don't erase any of it.
- The LENS COVER warning blinks for about 5 seconds when the camcorder is turned on, whether the cover is open or closed.



RECORDING Basic Features

11

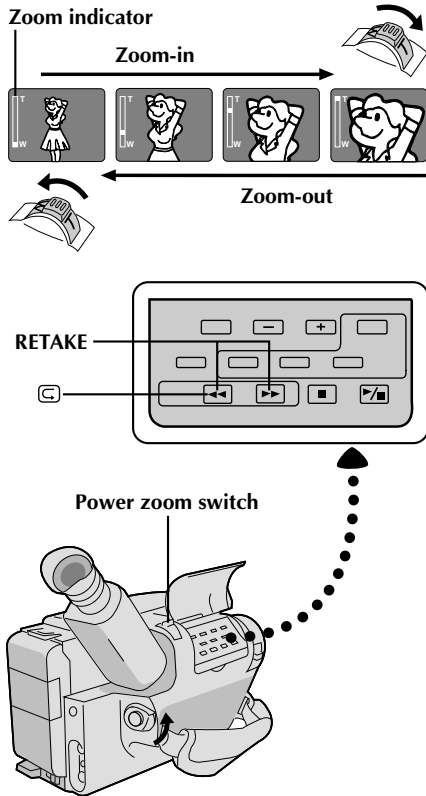

FEATURE:	Zooming
PURPOSE:	To vary the length of the focal lens and produce zoom in/out effect.
OPERATION:	<i>Zoom In</i> 1) Pull the power zoom switch down toward "T". <i>Zoom Out</i> 2) Push the switch up toward "W".
NOTES:	<ul style="list-style-type: none"> • The further the power zoom switch is pushed or pulled, the faster the zoom speed becomes. • Focusing may become unstable during zooming. In this case, set zoom while in Record-Standby, set manual focus or Focus Lock (pg. 18, 19), then zoom in or out in Record mode.
FEATURE:	Quick Review
PURPOSE:	To check end of last recording for confirmation.
OPERATION:	1) Press "⏪" for less than 2 seconds during Record-Standby mode. <ul style="list-style-type: none"> • Tape is rewound for about 2 seconds and played back automatically, then pauses in Record-Standby mode for next shot.
NOTE:	<i>Distortion may occur at start of playback. This is normal.</i>
FEATURE:	Retake
PURPOSE:	To re-record certain segments.
OPERATION:	1) Make sure camcorder is in Record-Standby mode. 2) Press either RETAKE button to reach start point for new recording. 3) Press Recording Start/Stop to start recording.
NOTE:	<i>Noise may appear during Retake. This is normal.</i>

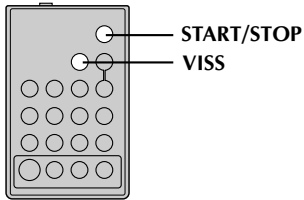
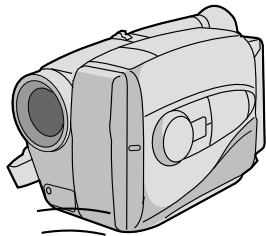

RM-V704U (provided with GR-AX460, optional for GR-AX360/AX260)

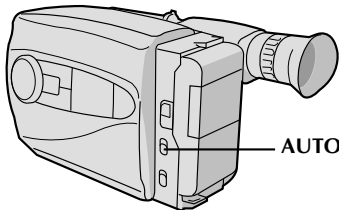

AUTO PAUSE

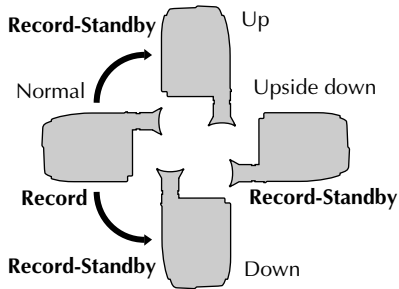

FEATURE:	Index Code Marking
PURPOSE:	To give you automatic access to any selected point on a recording. Auto Marking and Manual Marking are available.
OPERATION:	<i>Auto Marking</i> An index code is always marked to start the first recording on a new date after a cassette is inserted. <i>Manual Marking</i> 1) Press VISS once to place index code. INDEX blinks in the viewfinder during marking.
NOTES:	<ul style="list-style-type: none"> • If VISS is pressed during Record-Standby mode, the mark is placed where START/STOP is pressed. • If the date changes during a recording, it becomes the first recording of the new date and an index mark is placed at that point.
FEATURE:	AUTO PAUSE SYSTEM (GR-AX460 only)
PURPOSE:	To automatically stop recording when the camcorder is pointed down, preventing accidental recordings of the ground, your feet, etc.
OPERATION:	1) Set AUTO PAUSE to "ON". When the camcorder is tilted down by a large degree from its horizontal position during recording, the Record-Standby mode is automatically engaged. "AUTO PAUSE" appears in the viewfinder.
NOTES:	<ul style="list-style-type: none"> • The Auto Pause System is also effective when the camcorder is pointed up, or is positioned upside down. • Auto Pause also works when the camcorder is twisted by a large degree to the left or right. • When you want to shoot in any of the aforementioned positions, make sure you set AUTO PAUSE to "OFF".



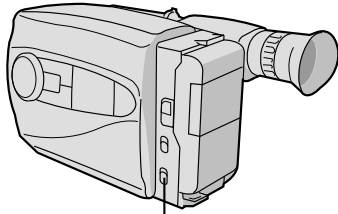

LIGHT ON/AUTO/OFF

Video Light (GR-AX460 only)

When natural lighting is too dim, you can brighten the scene by using the built-in video light.

SET VIDEO LIGHT

1 Set the LIGHT ON/AUTO/OFF as required.

- ON : Always keeps the light on as long as the camcorder is turned on.
- AUTO : Automatically turns on the light when the camcorder senses insufficient lighting on the subject.
- OFF : Turns off the light.
 - The video light can be used with the camcorder's power on.
 - It is recommended to set the white balance to indoor mode (☀) (☞ pg. 15) when you use the video light.
 - When not using the video light, turn it off to save battery power.

NOTES:

- Even if the battery indicator (☐) does not blink in the viewfinder, if the battery pack's charge is low, the camcorder may turn off automatically when you turn on the video light, or when you start recording with the video light turned on.
- When the LIGHT ON/AUTO/OFF is set to "AUTO":
 - Depending on the lighting condition, the video light may not be stably turned on or off. In this case, switch the light on and off manually.
 - While the Sports or High-Speed Shutter mode (☞ pg. 14) is engaged, the light is likely to stay on.
 - While the Twilight mode (☞ pg. 14) is engaged, the light will not activate.

DANGER:

- The video light becomes extremely hot. Do not touch it either while in operation or soon after turning it off, otherwise serious injury may result.
- Do not place the camcorder into the carrying case immediately after using the video light, since it remains extremely hot.
- When operating, keep a distance of about 30 cm between the video light and people or object.
- Do not use near flammable or explosive materials.
- It is recommended that you consult your nearest JVC dealer for replacing the video light.



14 RECORDING Advanced Features (cont.)

Program AE With Special Effects

All you have to do to access any of the variety of shooting effects is to turn the PROGRAM AE select dial until the desired indication appears in the viewfinder. The mode is activated about 1 second later.

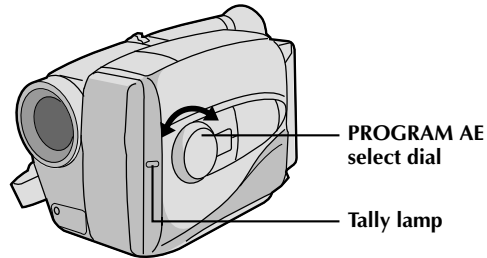

DIAL SYMBOL	VIEWFINDER	MODE
LOCK	AUTO LOCK	Auto Mode Lock

Auto Mode Lock

Locks camcorder in Full Auto mode, preventing accidental misoperation/button pressing during shooting.

- CINEMA, FADER, FOCUS, EXPOSURE, DISPLAY, TITLES and MWB (Manual White Balance) controls are disabled in this mode.

DIAL SYMBOL	VIEWFINDER	MODE
RELEASE	AUTO RELEASE	Auto Mode Release

Auto Mode Release

Re-enables controls that were disabled by Auto Mode Lock.

DIAL SYMBOL	VIEWFINDER	MODE
FG	FG:FOG	Electronic Fog Filter

Electronic Fog Filter

Makes picture look misty white, as when external fog filter is attached to lens. Softens image and gives it "fancy" look.

DIAL SYMBOL	VIEWFINDER	MODE
ND	ND:ND EFFECT	ND Effect

ND EFFECT

Black mist darkens picture, as when ND filter is used. Helps to counter effects of glare on subject.

DIAL SYMBOL	VIEWFINDER	MODE
	SEPIA	Sepia

Sepia

Scene being shot is recorded in sepia-tinted (reddish-brown) monochrome, giving effect of older movie. Use together with Cinema (pg. 17) for authentic look of classic Hollywood movie.

DIAL SYMBOL	VIEWFINDER	MODE
	TWILIGHT	Twilight

Twilight

Disengages auto gain control and auto focus, locks focus to infinity and white balance to "☀" (outdoor) mode. Dusk, twilight scenery, fireworks, etc., look more natural and dramatic.

DIAL SYMBOL	VIEWFINDER	MODE
	SPORTS	Sports

Sports

High shutter speed clearly captures fast-moving action.

DIAL SYMBOL	VIEWFINDER	MODE
1/2000	S 1/2000	High Speed Shutter

High-Speed Shutter (1/2000s.)

Captures faster action than Sports mode.

DIAL SYMBOL	VIEWFINDER	MODE
	SELF TIMER	15 sec. Self-Timer

15 sec. Self-Timer

Lets you delay recording start after Recording Start/Stop is pressed. If camcorder is secured, operator can enter scene before recording starts.

- 1) Set PROGRAM AE dial to "☺". "☺ 15S" appears in viewfinder.
- 2) Press Recording Start/Stop.
 - Recording starts after 15 seconds.
 - Tally lamp begins blinking; blinking speed increases about 5 seconds before recording starts. Blinking stops when recording begins but light stays on.

NOTES:

- Only one effect can be engaged at a time.
- When the PROGRAM AE select dial is switched from one mode to another, the newly selected mode's name and its indication is displayed in the viewfinder for approx. 3 seconds. Then the name disappears, and only the indication remains.
- The screen becomes slightly reddish when the fader (pg. 16) is used in the Sepia mode.
- The screen becomes slightly dark in the High Speed Shutter mode. Use in well-lighted situations.
- In the High Speed Shutter or Sports modes, picture colour may be adversely affected if subject is lit by alternating discharge-type light sources such as flourescent or mercury-vapour lights.

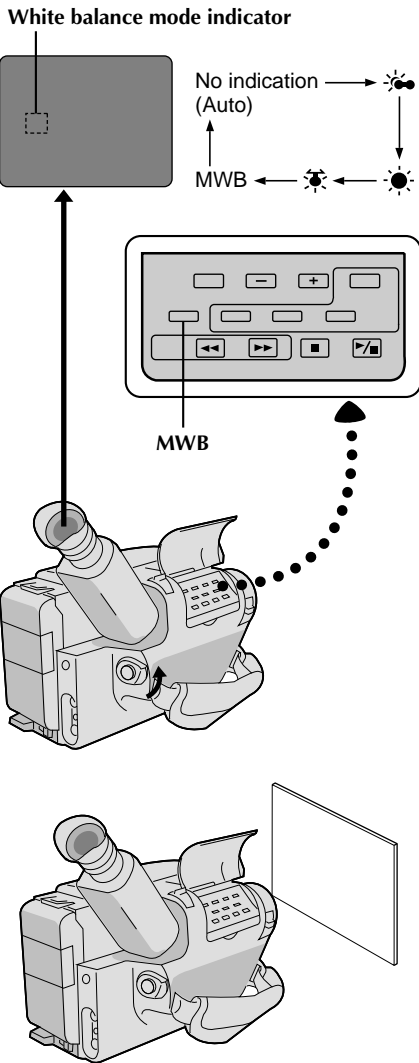

White Balance Adjustment

This camcorder's Automatic Colour Temperature system senses the colour temperature of the ambient lighting for automatic white balance adjustment. However, precise colour adjustment is not possible under the following conditions:

- When an object is in various shades of the same colour.
- When a predominantly red or brown object is being shot outdoors.

In these cases, use the camcorder's built-in preset filters for white balance adjustment.

SELECT MODE

1 Press **MWB** (Manual White Balance) until the required indication appears in the viewfinder.

- "☀•" Outdoors on cloudy day
- "☀" Outdoors on sunny day
- "☀•" Light source is halogen or tungsten lamp
- "MWB" With a memorized personal White Balance setting (see below)

MWB sets the colour temperature for the subject's light source so you can shoot with natural colours that are unaffected by surroundings, even when there are multiple subjects with different colour temperatures.

ADJUST FOCUS

1 Point the camcorder at a white, flat object such as a sheet of white paper, and adjust focus manually (☞ pg. 19).

ADJUST WHITE BALANCE

2 Press **MWB** until "MWB" appears, then press and hold **MWB** for more than 3 seconds.

- "MWB" blinks in the viewfinder during adjustment, then stops blinking but stays lit when adjustment is complete.

NOTES:

- To switch to automatic white balance adjustment, press **MWB** until the indication disappears, or turn the **PROGRAM AE** dial to **LOCK**.
- Re-adjust the White Balance Mode when the lighting has changed, when the camcorder has been turned on and off again, or when the **PROGRAM AE** dial's position has been changed.
- It is helpful to connect your camcorder to a colour monitor when adjusting the white balance ("BASIC CONNECTIONS" ☞ pg. 27).
- When adjusted by putting coloured paper in front of the subject in step 2, this unit makes its colour temperature standard for automatic white balance. So you can enjoy shooting with different colours. For example, when adjusting with red, blue or yellow colours, the image becomes the colour which approximates to green, orange or purple respectively.



16

RECORDING Advanced Features (cont.)

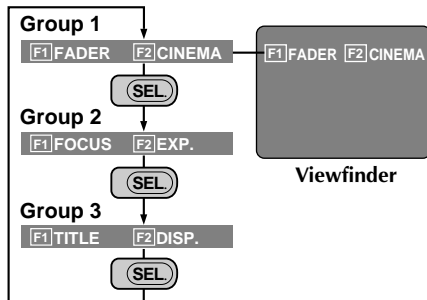

PROGRAM AE select dial

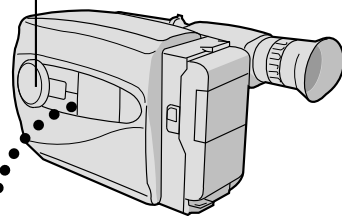

F1 button F2 button

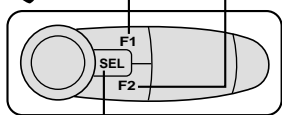

Function SEL. button

FADE IN



FADE OUT

INTELLIGENT FUNCTION CONTROL

This feature makes it easier for you to make selections during the following modes: **Fader, Cinema, Manual Focus Adjust, Exposure Control, Display, and Instant Title.**

1 PREPARATION

Set the **PROGRAM AE** dial to any position except **LOCK**.

2 SELECT MODE

Press **Function SEL.** until the required function's indication appears in the viewfinder.

3 ENTER SELECTION

Press either **F1** or **F2** (the one to the immediate left of the desired function name).

NOTE:

If you set the **PROGRAM AE** dial to **LOCK**, **F1** and **F2** disappear from the viewfinder, indicating that **IFC** (Intelligent Function Control) is unusable.

Fader

This feature allows smooth fade-in and fade-out to black blank screen. Fade-in works at recording start, and fade-out works at recording end or when you enter Record-Standby mode.

1 SELECT MODE

Press **Function SEL.** until "FADER" appears to the right of **F1**.

2 ENGAGE FADE-STANDBY MODE

Press **F1** to engage the Fade-Standby mode. "FADER" appears in the viewfinder.

3 START RECORDING

Press Recording Start/Stop to start recording and activate fade-in.

OR . . .

END RECORDING

Press Recording Start/Stop to end recording and engage fade-out.

NOTES:

- Pressing and holding the Recording Start/Stop button allows you to record a black blank screen.
- The screen becomes slightly reddish when the Fader is used with Sepia (☞ pg. 14).
- With the Electronic fog filter mode (☞ pg. 14) engaged, the image fades in/out to a white screen.

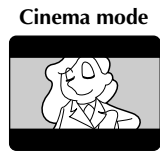

Cinema

This feature allows you to record black bars at the top and bottom of the screen to produce a cinema-like "wide-screen" effect.

- 1** **SELECT MODE**
Press **Function SEL.** until "CINEMA" appears to the right of F2.
- 2** **ENGAGE CINEMA MODE**
Press **F2.**
- 3** **RESTORE NORMAL SCREEN**
Press **F2** again while "CINEMA" appears next to F2 in the viewfinder.

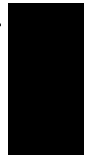

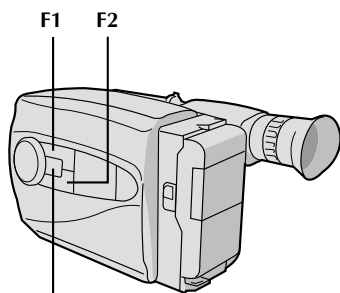
Focus
detection zone

Function SEL.

Focusing

Auto Focus

The camcorder's Full Range AF system offers continuous shooting ability from close-up to infinity. However, correct focus may not be obtainable in the situations listed below (in these cases use manual focusing):

- When two subjects overlap in the same scene.
- When illumination is low.*
- When the subject has no contrast (difference in brightness and darkness), such as a flat, one-colour wall, or a clear, blue sky.*
- When a dark object is barely visible in the viewfinder.*
- When the scene contains minute patterns or identical patterns that are regularly repeated.

* The low-contrast warning "▲◀▶▲" appears in the viewfinder.

Focus Lock

This feature locks the focus in place, which is especially helpful in the following situations:

- When things pass between your subject and the camcorder. Engage the focus lock function to lock your subject in before recording.
- When you want your subject to be focused, and to appear in a corner of the screen. First, centre on the subject and focus using auto focus mode. Then engage the focus lock function and move the camcorder until the subject is where you want it.

SELECT MODE

- 1 Press **Function SEL.** until "FOCUS" appears to the right of F1.

LOCK FOCUS

- 2 Press **F1.** The focus lock indication "◀▶" appears in the viewfinder.

RELEASE FOCUS LOCK

- 3 Press **F1.** Focus lock is immediately released. The focus lock indication disappears.

NOTES:

- If the lens is smeared or blurred, accurate focusing is not possible. Keep the lens clean, wiping with a piece of soft cloth if it gets dirty. When condensation occurs, wipe with a soft cloth or wait for it to dry naturally.
- When shooting a subject close to the lens, zoom-out first (☞ pg. 11). If zoomed-in in the auto focus mode, the camcorder could automatically zoom out depending on the distance between the camcorder and the subject.

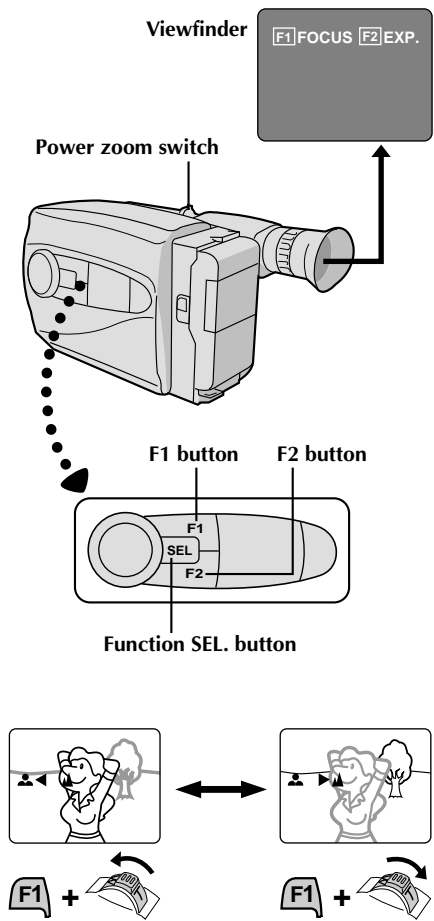

Manual Focus

NOTE:

You should already have made the necessary viewfinder adjustments (pg. 7). If you haven't, do so before continuing.

1 SELECT MODE

Press **Function SEL.** until "FOCUS" appears to the right of F1.

2 ADJUST FOCUS

[A] TO FARTHER SUBJECT

While holding down **F1**, slide the power zoom switch to T. The Manual Focus indications "▶▲" appear and "▶" blinks.

Go to step 3.

[B] TO NEARER SUBJECT

While holding down **F1**, slide the power zoom switch to W. The Manual Focus indications "◀▲" appear and "◀" blinks.

Go to step 3.

3 LOCK FOCUS

Release the power zoom switch. The focus indication is replaced by the focus lock indication "◀▶" and the adjusted focus is locked in.

4 RELEASE MANUAL FOCUS MODE

Press **F1**. The Manual Focus mode is immediately released and the focus lock indication disappears.

NOTES:

- Be sure to focus the lens in the maximum telephoto position when you use the Manual Focus mode. If you focus in on a certain subject in the wide-angle position, sharply focused images cannot be obtained when zoomed up because the depth-of-field is reduced at longer focal lengths.
- Two manual focusing speeds are available. For slow-speed, push the switch slightly and hold that position. For fast-speed, push the switch fully.
- When the focus level cannot be adjusted any farther or closer, "▶▲" or "◀▲" will blink.

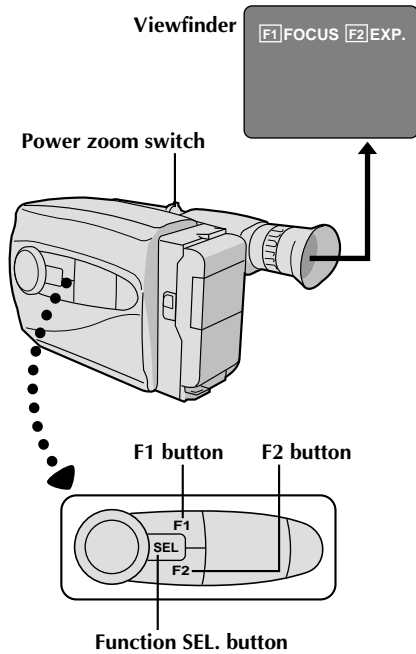

Exposure Control

This feature automatically adjusts the iris for the best available picture quality, but you can override and make the adjustment manually.

- 1 SELECT MODE**
Press **Function SEL.** until "EXP." appears to the right of F2.

- 2 BRIGHTEN IMAGE**
While holding down **F2**, slide the power zoom switch to T. The Exposure indicator bar appears in the viewfinder.
OR . . .
DARKEN IMAGE
While holding down **F2**, slide the power zoom switch to W. The Exposure indicator bar appears in the viewfinder.
When you want to return to the factory setting . . .

- 3 RESTORE INITIAL SETTING**
Press **F2**. The standard setting is immediately restored and the Exposure indicator bar disappears.

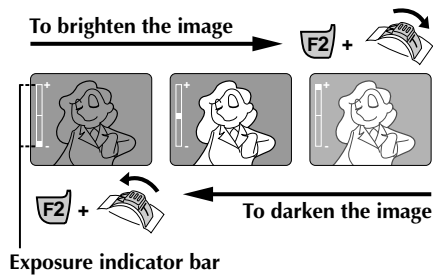

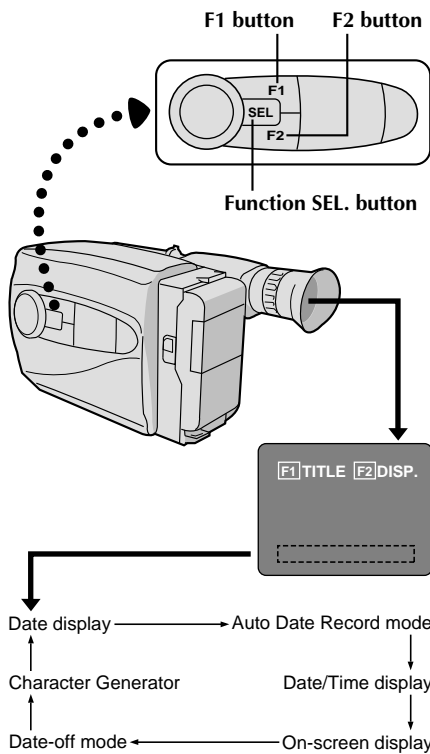

Date display	Auto Date Record mode	
	Auto date record mode	Auto date record executed
Date/Time display	Character Generator	
	No Characters stored	Example of stored characters

NOTES:

- In the On-Screen Display mode, the date is displayed and recorded.
- The on-screen display is not available during recording.

Date/Time Character Insert

This feature allows you to display date, time and characters in your viewfinder and on a connected colour monitor, record them manually or automatically, and even make your own titles.

NOTE:

You should already have performed the Date/Time Setting procedure (pg. 6). If you haven't, do so before continuing.

DISPLAY

1 SELECT DISPLAY

Press **Function SEL.** until "DISP." appears to the right of F2.

2 CHOOSE DISPLAY MODE

Press **F2** while in Record-Standby to cycle through the modes as shown in the illustration at left.

NOTES:

- The selected display can be recorded.
- If you don't want to record the display, select Date-off mode before shooting.
- If you want to delete the display during shooting, press **F2**.
- If you want to call back a deleted display, engage the Record-Standby mode and then select the desired display mode using **F2**.

AUTO DATE RECORD

Your camcorder automatically records the day, month and year for about 5 seconds after recording is initiated in the following situations:

- After changing the date.
- After loading a cassette.
- After Auto Date Record mode is selected by pressing **F2**. In this mode, the month, day and year are replaced after 5 seconds with "AUTO DATE".

NOTES:

- Setting **PROGRAM AE** to **LOCK** always engages this mode, and disables all other modes.
- In the Auto Date Record mode, if the date changes while you're shooting, the date indication is recorded for about 5 seconds from that point. It is not recorded during any other recordings made on that day.

ON-SCREEN DISPLAY

CONNECT CAMCORDER TO MONITOR

1 Connect the camcorder to a monitor as instructed in "BASIC CONNECTIONS" (pg. 27).

DISPLAY VIEWFINDER INDICATIONS

2 Press **F2** until the indications appear on the connected monitor.

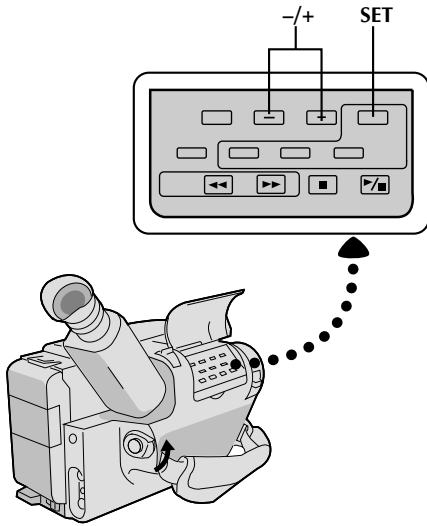

Character Generator

- 1 SELECT MODE**
Press **Function SEL.** until "DISP." appears to the right of F2.
- 2 SET CHARACTER OR TITLE**
Press **F2** until "SET CHAR" or a previously stored title appears in the viewfinder.
- 3 ACCESS CHARACTER MODE SCREEN**
Press **SET**. A character grid appears in the viewfinder.
- 4 ENTER DESIRED CHARACTERS**
Press **+** or **-** to move the cursor on the character grid to the desired character, then press **SET** to enter. The selected characters appears at the bottom of the screen. When you're done, press **SET** as many times as necessary to exit the screen. The title you made appears at the bottom of the screen.

NOTES:

- You can store up to 18 characters.
- You can only make and store one title at a time. To replace it, repeat the procedure.
- To create a space between two characters in a title you make, choose "□" on the CHARACTER SET MODE screen.

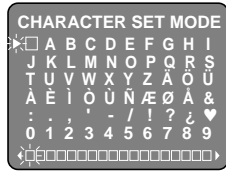

CHARACTER SET MODE screen



CHARACTER SET MODE screen

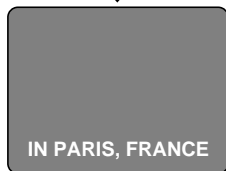

IN PARIS, FRANCE



Example of Character Generator & Title

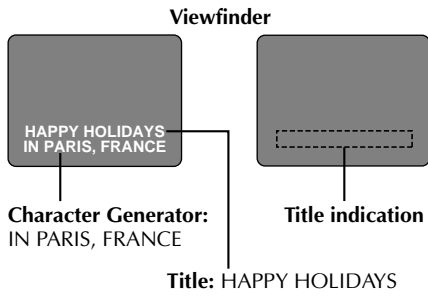

Instant Titles

The camcorder has eight preset titles in memory. You can superimpose one of them above a previously stored title as shown in the illustration to the left. The preset titles appear in this order: HAPPY BIRTHDAY, HAPPY HOLIDAYS, OUR FAMILY, MOVIE STAR, PARTY TIME, MERRY CHRISTMAS, WEDDING DAY, CONGRATULATIONS.

1 SELECT MODE

Press **Function SEL.** until "TITLE" appears to the right of F1.

2 SELECT PRESET TITLE

Engage the Record-Standby mode, then press **F1** to cycle through the preset titles until the desired title is displayed.

NOTES:

- To delete the Instant Title during recording, press **F1**.
- To recall a title, engage the Record-Standby mode and then press **F1** to select the desired title.
- To display a title you made in the position usually occupied by an Instant Title, cycle through in step 2 above until your title appears (after "CONGRATULATIONS"). You can superimpose two personal titles on the scene being shot.

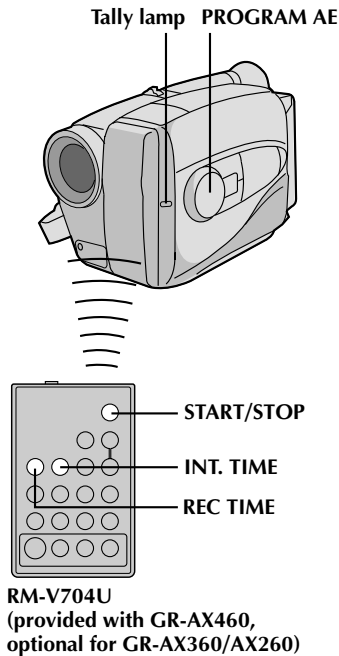

Self-Timer

You can set the delay between pressing Recording Start/Stop and the actual start of recording. If you secure the camcorder, you (or whomever is operating the camcorder) can enter the scene before recording starts.

NOTE:

You need the RM-V704U remote control unit to perform this procedure.

ENGAGE RECORD-STANDBY MODE

- 1 Make sure the lens cover is open, set the power switch to CAMERA.

SET TIME DELAY

- 2 On the RM-V704U, press **INT. TIME** to set the delay time. There are four choices, and they appear in the viewfinder in the following order (each time **INT. TIME** is pressed): 15S (15 seconds), 30S (30 seconds), 1MIN (1 minute) and 5MIN (5 minutes). Pressing again releases the Self-timer.

START DELAYED RECORDING

- 3 Press Recording Start/Stop. The tally lamp begins blinking, and the blinking speed increases about 5 seconds before recording starts. When recording begins, the lamp stops blinking but stays lit.

RELEASE SELF-TIMER MODE

- 4 To release when the tally lamp is not blinking, press **INT. TIME** continuously until "☺" disappears. To release when the tally lamp is blinking, press Recording Start/Stop to stop the blinking, then press **INT. TIME** continuously until "☺" disappears.

NOTE:

If the **PROGRAM AE** dial is set to "☺", 15S is automatically selected.



Animation

Give stationary scenes or objects an illusion of movement. This function allows you to shoot a series of pictures, each slightly different, of the same object for a brief period of time.

NOTE:

You need the RM-V704U remote control unit to perform the following procedure.

ENGAGE RECORD-STANDBY MODE

1 Make sure the lens cover is open, then set the power switch to CAMERA.

SET RECORDING TIME

2 Press **REC TIME** on the remote control. Three choices are available, and they appear in the following order (each time **REC TIME** is pressed): 1/4S (one-fourth of a second), 1/2S (one-half of a second) and 1S (one full second). Press again to release the Animation mode.

START RECORDING

3 Press Recording Start/Stop after focusing on the subject. The recording stops automatically after the selected period of time.

ASSEMBLE SERIES OF PICTURES

4 Repeat steps 2 and 3 for the desired number of pictures.

CHECK YOUR WORK

5 Play back the series of pictures to see if the results were satisfactory.

RELEASE ANIMATION MODE

6 Press **REC TIME** until "■" disappears from the viewfinder.

NOTES:

- For best results, make sure the camcorder is secured when shooting.
- If the **PROGRAM AE** dial is set to Self-Timer mode, Animation is cancelled and Self-Timer mode is engaged with 15S selected.
- Fade-in/out cannot be performed during Animation shooting.

Time-Lapse

You can record sequentially at preset time spans. Leaving the camcorder aimed at a specific subject, you can record subtle changes over an extended period of time.

NOTE:

You need the RM-V704U remote control unit to perform the following procedure.

ENGAGE RECORD-STANDBY MODE

1 Make sure the lens cover is open, then set the power switch to CAMERA.

SET RECORDING TIME

2 Press **REC TIME** on the remote control. There are three choices available, and they appear in the following order (each time **REC TIME** is pressed): 1/4S, 1/2S and 1S. Press again to reset.

SET INTERVAL BETWEEN RECORDINGS

3 Press **INT. TIME** on the remote control. There are four choices available, and they appear in the following order (each time **INT. TIME** is pressed): 15S, 30S, 1MIN, and 5MIN. Press again to reset.

START TIME-LAPSE RECORDING

4 Press Recording Start/Stop. Recording and intervals alternate automatically.

RELEASE TIME-LAPSE MODE

5 To release when the tally lamp is not blinking, press **INT. TIME** and **REC TIME** repeatedly until "■" and "☺" disappear. To release when the tally lamp is blinking, press Recording Start/Stop to stop the blinking, then press **INT. TIME** and **REC TIME** repeatedly until "■" and "☺" disappear.

NOTES:

- Fade-in/out cannot be performed during Time-Lapse shooting.
- For best results, keep the camcorder secured while shooting.
- If, during steps 2 and 3, the **PROGRAM AE** dial is set to the Self-Timer mode, the Self-Timer mode is engaged with 15S selected.

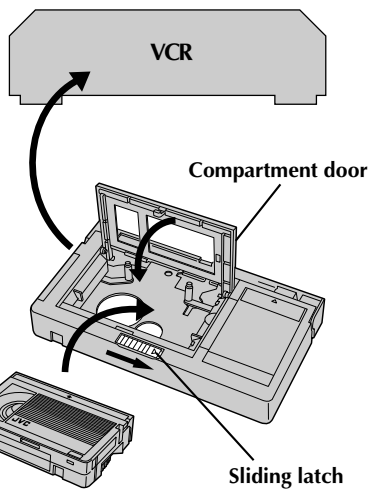
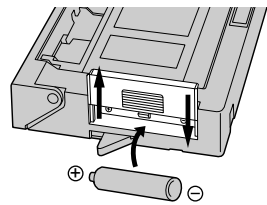

Compact video cassette

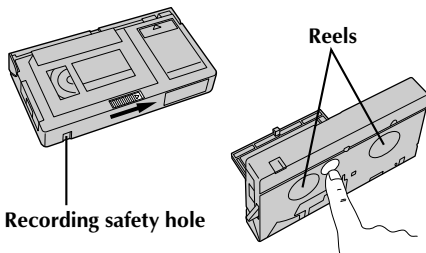

Cassette Adapter

Use this to play back a VHS-C video cassette recorded with this camcorder. It is fully compatible with any VHS video cassette recorder. The C-P7U adapter is battery powered and automatically performs tape loading and unloading.

1 INSERT BATTERY

Slide the battery cover up to remove it, and install one "R6(AA)" size battery as shown in the illustration at left. Then reattach the cover.

2 INSERT CASSETTE IN ADAPTER

Slide the latch to open the adapter compartment door, then insert the cassette and close the compartment door.

3 PLAY BACK ON CONNECTED VCR

Load the cassette adapter into the VCR and play the tape back as you would any other.

4 REMOVE CASSETTE FROM ADAPTER

Slide the latch and the compartment door opens automatically. Then insert your finger in the hole on the underside of the adapter as shown in the illustration at left, push up and remove the cassette.

NOTES:

- During tape loading and unloading, do not touch the reels for safety and tape protection.
- During special-effect playback (slow motion, still frame, etc.), the picture may vibrate or noise bars may appear on the screen.
- To record on a VCR using a compact cassette and the adapter, cover the adapter's recording safety hole with adhesive tape.

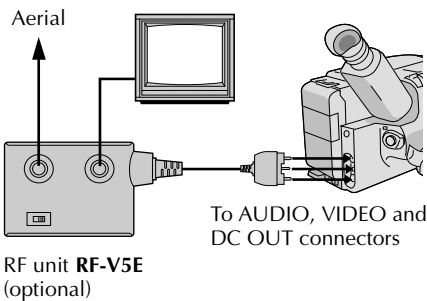
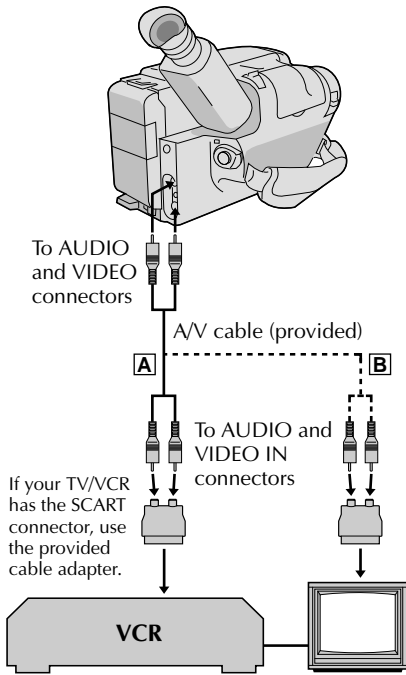

NOTES:

- It is recommended to use the AC Power Adapter/Charger as the power supply instead of the battery pack.
- To monitor the picture and sound from the camcorder without inserting a tape, set the camcorder's power switch to CAMERA, then set your TV to the appropriate input mode.
- If you have a TV or speakers that are not specially shielded, do not place the speakers adjacent to the TV as interference will occur in the camcorder playback picture.

There are three basic types of connections. When making the connections, refer also to your VCR and TV instruction manuals.

**Connection To A VCR [A]
(Editing, Dubbing and Playback)**

NOTE:

Use the provided A/V cable.

- 1 CONNECT CAMCORDER TO VCR**
As shown in the illustration at left, connect the provided A/V cable. between the AUDIO and VIDEO connectors on the camcorder and those on the VCR.
- 2 SUPPLY POWER**
Turn on the camcorder, the VCR and the TV.
- 3 SELECT MODE**
Set the VCR to its AUX input mode, and set the TV to its VIDEO mode.

**Connection To A TV With A/V Input
Connectors [B] (Playback ONLY)**

NOTE:

Use the provided A/V cable.

- 1 CONNECT CAMCORDER TO TV**
As shown in the illustration at left, connect the provided A/V cable. between the AUDIO and VIDEO connectors on the camcorder and those on the TV.
- 2 SELECT MODE**
Set the TV to its VIDEO or AV mode (as specified in its instructions).

**Connection To A TV With NO A/V Input
Connectors (Playback ONLY)**

NOTE:

Use the optional RF-V5E RF unit.

* Refer to the RF-V5E instruction manual for connection procedure.

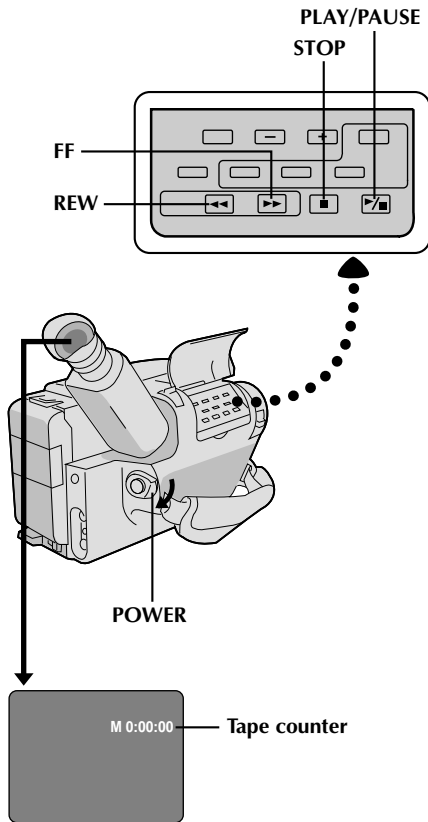

NOTE:

Make sure you connect your camcorder as directed in "BASIC CONNECTIONS" (pg. 27).

- 1 LOAD A CASSETTE**
Load as you did in the recording procedure.
- 2 SELECT MODE**
Set the power switch to PLAY. The Power On indicator lights.
- 3 PLAYBACK**
Press **PLAY/PAUSE**. The playback picture appears in the viewfinder and the connected TV.
- 4 STOP PLAYBACK**
Press **STOP**.

Rewind or Fast-forward the Tape

Press **REW** to rewind, or **FF** to fast-forward the tape during stop mode.

NOTE:

The camcorder shuts off automatically after about 5 minutes in **STOP** mode. To turn on again, set the power switch to **POWER OFF**, then to **PLAY**.





PLAYBACK Features

29

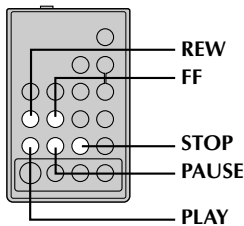
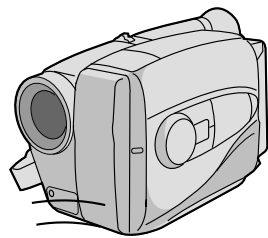
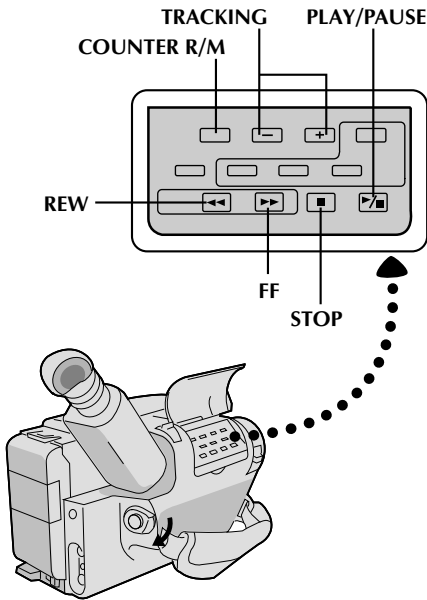

RM-V704U
(provided with GR-AX460,
optional for GR-AX360/AX260)

FEATURE:	Manual Tracking
PURPOSE:	To eliminate noise bars that appear on the screen.
OPERATION:	1) Press either TRACKING button as many times as necessary for best picture.
NOTES:	<ul style="list-style-type: none"> • To reset TRACKING to the original preset, press both TRACKING buttons simultaneously. • Manual Tracking may not work with tapes recorded on other VCRs or camcorders.
FEATURE:	Still Playback
PURPOSE:	To pause during playback.
OPERATION:	1) Press PLAY/PAUSE during playback. 2) To resume normal playback, press PLAY/PAUSE again.
NOTE:	Noise bars appear and pictures may become monochrome during Still Playback. This is normal.
FEATURE:	Shuttle Search
PURPOSE:	To allow high-speed search in either direction.
OPERATION:	Forward Search 1) Press FF during playback. Reverse Search 1) Press REW during playback.
NOTE:	Noise bars appear and pictures may become monochrome in Shuttle Search. This is normal.
FEATURE:	Counter Memory Function
PURPOSE:	To make it easier to locate a specific tape segment.
OPERATION:	1) Press COUNTER R/M and hold for more than 2 seconds. The counter resets to "0:00:00". 2) Press COUNTER R/M . "M" appears. 3) After recording or playback, press STOP , then REW . The tape automatically stops at or close to 0:00:00. 4) Press PLAY/PAUSE to start playback.
NOTES:	<ul style="list-style-type: none"> • The counter memory functions in the FF and REW modes. • To disable Counter Memory Function, press COUNTER R/M so the "M" disappears.

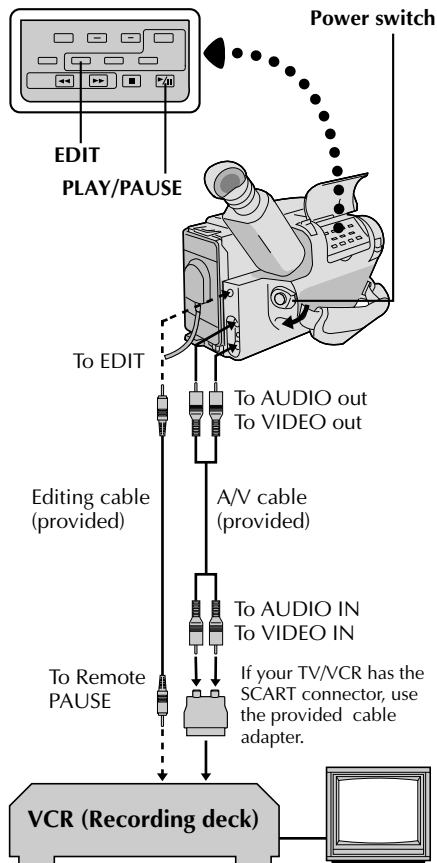

Tape Dubbing

CONNECT EQUIPMENT

- 1 Following the illustration at left, connect the camcorder and the VCR. If you have a Remote PAUSE terminal, use the editing cable to connect it to the camcorder and the VCR. (See "NOTES" below for details.)

PREPARE FOR DUBBING

- 2 Set the camcorder's power switch to PLAY, turn on the VCR's power, and insert the appropriate cassettes in the camcorder and the VCR.

SELECT VCR MODE

- 3 Engage the VCR's AUX and Record-Pause modes.

FIND EDIT-IN POINT

- 4 Engage the camcorder's Play mode to find a spot just before the edit-in point. Once it's reached, press PAUSE on the camcorder.

START EDITING

- 5 Press EDIT on the camcorder and engage the VCR's Record mode.

STOP EDITING TEMPORARILY

- 6 Engage the VCR's Record-Pause mode and press PAUSE on the camcorder.

EDIT MORE SEGMENTS

- 7 Repeat steps 4 through 6 for additional editing, then stop the VCR and camcorder when finished.

NOTES:

- When using a Remote PAUSE terminal, pressing EDIT on the camcorder in step 5 automatically engages the VCR's Record mode.
- When using a Remote PAUSE terminal, you can access a function called Master Edit Control System. Before beginning, reset the camcorder's counter to "0:00:00" at an edit-out point. When the tape reaches this point (remember there's a small margin of error) during editing, the camcorder and VCR pause automatically. However, some VCRs are not compatible with the Master Edit Control System.

Random Assemble Editing [R.A.Edit]

Create edited videos easily using your camcorder as the source player. You can select up to 8 "cuts" for automatic editing, in any order you like. R.A. Edit is more easily performed when the RM-V704U* MBR (Multi-Brand Remote) is set to operate with your brand of VCR (see chart on the next page), but can also be performed by operating the VCR manually.

* RM-V704U is provided with GR-AX460, optional for GR-AX360/AX260.

CONTINUED ON NEXT PAGE

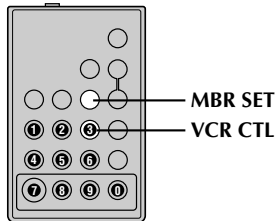

RM-V704U
(provided with GR-AX460,
optional for GR-AX360/AX260)

VCR CODE LIST

VCR BRAND NAME	BUTTONS (A) (B)	VCR BRAND NAME	BUTTONS (A) (B)
AKAI	6 2 6 4 7 7	PHILIPS	1 9 9 5 1 1 9 4 9 1 9 6 1 2 3 3
BLAUPUNKT	1 3	SANYO	3 6 3 5
FERGUSON	9 7 9 8 3 2	SELECO, REX	9 1 9 6
GRUNDIG	1 4 3 4	SHARP	1 5 1 0
HITACHI	6 6 6 3	SONY	6 5 6 0 3 9 3 1
JVC A B C	9 1 9 6 9 3	THOMSON, TELEFUNKEN, SABA, NORDMENDE	9 1 9 6 9 7 3 2
DAIICHI	6 7 6 8	TOSHIBA	6 9 6 1
NEC	3 7 3 8		
PANASONIC	1 3 1 7 1 1 9 4 1 8		

SET REMOTE/VCR CODE

SET REMOTE TO OPERATE VCR

1 Turn off the power to the VCR and point the remote toward the VCR's infrared sensor. Then, referring to the chart at left, press and hold **MBR SET**, and press button (A) and then (B).

- The code is automatically set once you release the **MBR SET** button, and the VCR's power comes on.

OPERATE THE VCR

2 Make sure the VCR's power is on. Then, while holding **VCR CTL**, press the button on the remote for the desired function. The functions the remote can control are PLAY, STOP, PAUSE, FF, REW and VCR REC STBY (you don't need to press **VCR CTL** for this one).

You're now ready to try Random Assemble Editing.

IMPORTANT

Although the MBR is compatible with JVC VCRs and those of many other makers, it may not work with yours or may offer limited functions.

NOTES:

- If the VCR's power doesn't come on in step 1, try another code from the chart.
- Some brands of VCR don't come on automatically. In this case, turn the power on manually and try step 2.
- If the RM-V704U is not able to control the VCR, use the controls on the VCR.

MAKE CONNECTIONS

CONNECT TO . . .

1 **A** JVC VCR EQUIPPED WITH REMOTE PAUSE TERMINAL

Connect the editing cable to the Remote PAUSE terminal.

B JVC VCR NOT EQUIPPED WITH REMOTE PAUSE TERMINAL

Connect the editing cable to the R.A.EDIT connector.

C NON-JVC VCR WITH NEITHER

Connect the editing cable to the RM-V704U's Pause-In jack.

All other connections are as shown in the illustration on page 32.

CONTINUED ON NEXT PAGE

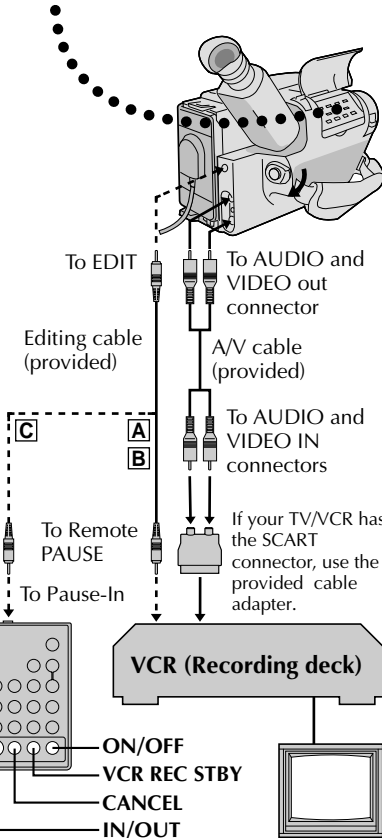
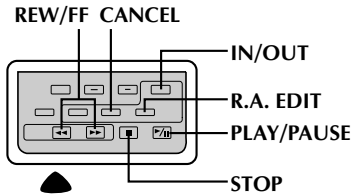

RM-V704U
(provided with GR-AX460,
optional for GR-AX360/AX260)

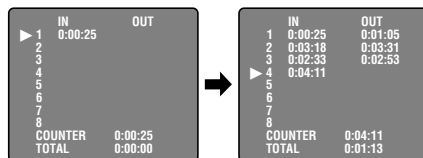

PREPARE CAMCORDER

2 Insert a recorded tape and set the power switch to PLAY.

PREPARE VCR

3 Turn the power on, insert a recordable tape and engage the AUX mode (refer to VCR's instructions).

SELECT SCENES

ACCESS R.A. EDIT COUNTER DISPLAY

1 Press **PLAY/PAUSE**, then press **R.A. EDIT** and the counter display appears in the viewfinder and the screen of the connected TV.

REGISTER BEGINNING OF SCENE

2 Press **REW** or **FF** to locate the beginning of a scene you want, then press **IN/OUT** to register that point. The data appears under IN on the display.

REGISTER END OF SCENE

3 Press **REW** or **FF** to locate the end of the scene and press **IN/OUT** to register it. The data appears under OUT on the display. The total time of the registered scene(s) is displayed at the bottom of the screen.

REGISTER ADDITIONAL SCENES

4 Repeat steps 2 and 3 for each additional scene (as many as 8).

MAKE CORRECTIONS

5 Press **CANCEL** during steps 2 and 3 to erase the most recently registered point.

NOTES:

- The RM-V704U can be used to operate other camcorder functions as well. Point the RM-V704U at the camcorder's remote sensor and press any of the following buttons (function appears in parentheses):
 - ON/OFF (camcorder R.A. EDIT)
 - IN/OUT (camcorder IN/OUT)
 - CANCEL (camcorder CANCEL)
- There must be at least one second between an in-point and its corresponding out-point.
- The camcorder prerolls during R.A. Edit, so there must be at least 15 seconds of recording material prior to any in-point.
- Blank portions of tape cannot be registered as in-points or out-points.
- If it takes more than 5 minutes to search for an in-point, the VCR's Record-Pause mode is cancelled and editing doesn't take place.
- Pressing **R.A. EDIT** clears all in- and out-points from memory.
- Leave a small margin for error around each in-point to ensure the scene is recorded in its entirety.

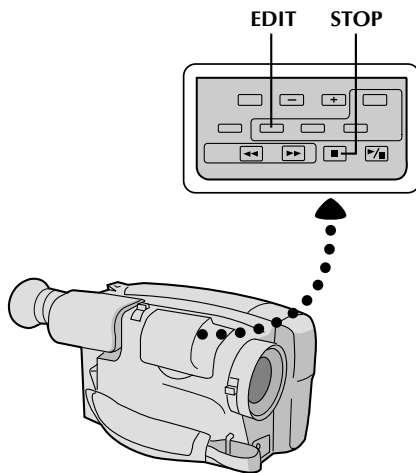
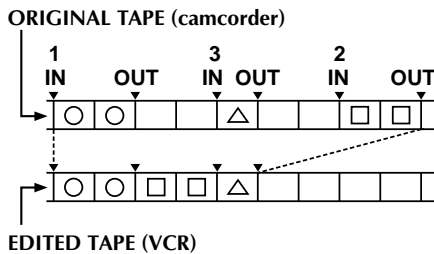

AUTOMATIC EDITING TO VCR

ENGAGE VCR'S RECORD-PAUSE MODE

- 1 Point the remote control toward the VCR's infrared sensor and press VCR REC STBY, or manually engage the VCR's Record-Pause mode.

BEGIN AUTOMATIC EDITING

- 2 Press **EDIT** on the camcorder, and the previously selected scenes are copied to the VCR in the specified order.

END AUTOMATIC EDITING

- 3 When all selected scenes have been copied, the camcorder and VCR enter the still or pause mode. Press **STOP** on both units.

NOTES:

- If you performed step 1C on page 31, keep the remote control pointed at the VCR during editing.
- The on-screen display only appears while the camcorder searches for each scene.
- To dub a copy of the camcorder's (source) tape, perform R.A. EDIT by specifying only one in-point (and no out-point). The contents of the tape from the specified in-point to the end of the tape are automatically copied.
- There may be noise at in- or out-points on the edited tape with certain VCRs.

SUPPLEMENTAL INFORMATION ON THE REMOTE CONTROL

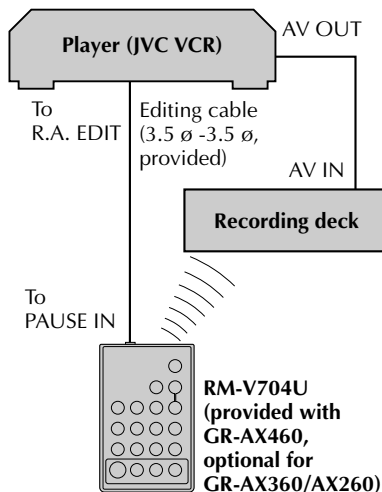

Using the RM-V704U remote control, it is also possible to perform deck-to-deck Random Assemble Editing. The playback deck must be an R.A. Edit-capable JVC VCR. The recording deck can be...

- a VCR other than JVC, or
- a JVC VCR which has **neither** a Remote PAUSE nor an R.A. EDIT connector

How to use:

- Connect the playback deck and RM-V704U as shown on the left.
- Set the RM-V704U to correspond to the brand of the recording deck. (☞ P. 31)
- For Random Assemble Editing procedure, please refer to the instruction manual of the JVC VCR you are using as the playback deck.

Notes:

- RM-V704U cannot be used to control the playback deck.
- RM-V704U is capable of controlling basic operations of the recording deck. While pressing VCR CTL, press PLAY, STOP, PAUSE, FF or REW for these functions. (Not possible with some brands and models). Other buttons cannot be used.
- To put the recording deck in the Record-Pause mode, use the controls on the recording deck itself.

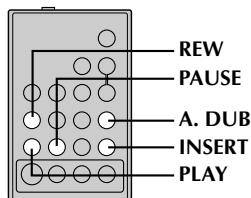
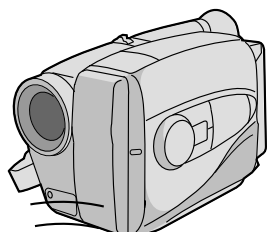
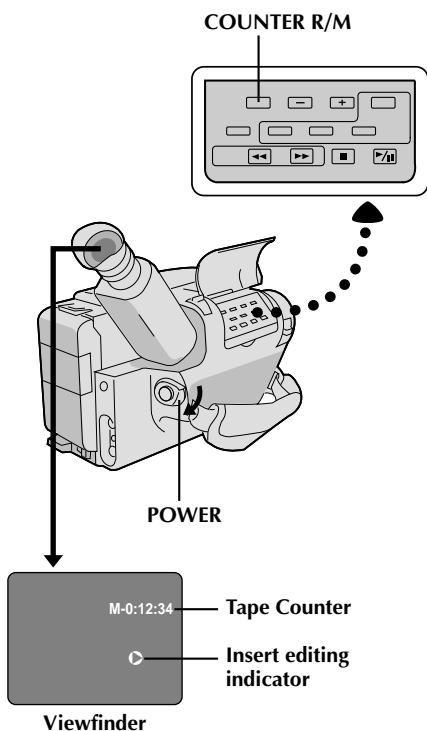

RM-V704U
(provided with GR-AX460,
optional for GR-AX360/AX260)

Insert Editing

You can record a new scene into a previously recorded tape, replacing a section of the original recording with minimal picture distortion at the in- and out-points. The original audio remains unchanged.

NOTE:

You need the RM-V704U remote control unit to perform the following procedure.

1 SELECT MODE

Set the power switch to PLAY.

2 FIND EDIT-OUT POINT

Locate the point and press **PAUSE** on the camcorder or the remote control.

3 RESET COUNTER

Press and hold **COUNTER R/M** for more than 2 seconds to reset the tape counter, then press for less than 1 second and make sure "M" appears in the viewfinder.

4 FIND EDIT-IN POINT

Press **REW** to go a little beyond the beginning of the scene you want to replace, press **PLAY** to view the recorded tape, and press **PAUSE** at exactly at the point where the new scene should start.

5 ENGAGE INSERT EDITING MODE

Press and hold **INSERT**, and press **PAUSE**. The Insert mode is engaged, and the scene the camcorder is aimed at appears on the screen.

6 BEGIN INSERT EDITING

Press Recording Start/Stop. When the counter reaches "0:00:00", editing stops automatically and the camcorder enters the playback mode.

NOTES:

- Insert Editing may not work correctly if a blank segment exists in the recorded tape.
- The tape may stop slightly before or after the designated end point, and noise bars may appear. Neither indicates a defect in the unit.
- To edit onto a tape with the recording safety tab removed, cover the hole with adhesive tape.
- Only video signal is recorded in the Insert Editing mode. When the sound is to be recorded, press A. DUB and PAUSE simultaneously after Step 5. When INSERT and PAUSE are pressed simultaneously again, the unit re-enters the Video-signal-only Recording mode.
- If the camcorder's mike is too close to the TV, or if the TV's volume is too high, whistling or howling may occur.

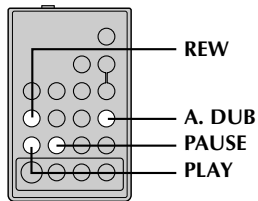
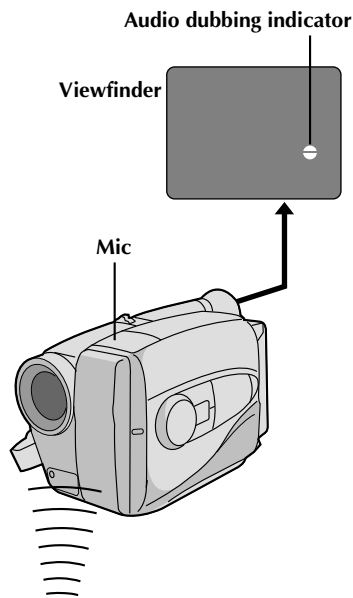

RM-V704U
(provided with GR-AX460,
optional for GR-AX360/AX260)

Audio Dubbing

You can record a new soundtrack on a prerecorded tape (normal audio only).

** Perform steps 1, 2 and 3 of the Insert Editing procedure (pg. 34) before continuing.

FIND EDIT-IN POINT

- 1 Press **REW** to go a little beyond the beginning of the scene onto which you want to dub new audio, press **PLAY** to view the recorded tape, then press **PAUSE** at exactly the point where dubbing should start.

ENGAGE AUDIO DUB STANDBY MODE

- 2 Press and hold **A. DUB**, and press **PAUSE**.

BEGIN AUDIO DUBBING

- 3 Press **PLAY**. When the counter reaches "0:00:00", Audio Dubbing stops automatically and the camcorder enters the playback mode.

NOTES:

- Audio Dubbing may not work correctly if the tape contains blank segments.
- If the camcorder's mike is too close to the TV, or if the TV's volume is too high, whistling or howling may occur.



36

INDEX Controls

Controls

- ① PROGRAM AE Select Dial pg. 14
- ② F1 [Function 1] Button pg. 16
- ③ PUSH Button pg. 7
- ④ Function SEL. Button pg. 16
- ⑤ F2 [Function 2] Button pg. 16
- ⑥ EJECT Switch pg. 7
- ⑦ AUTO PAUSE ON/OFF Switch
(GR-AX460 only) pg. 12
- ⑧ LIGHT ON/AUTO/OFF Switch
(GR-AX460 only) pg. 13
- ⑨ Diopter Adjustment pg. 7
- ⑩ Power Zoom Switch pg. 11
- ⑪ BATT. [Battery] RELEASE Switch pg. 4
- ⑫ MWB [Manual White Balance]
Button pg. 15
- ⑬ Tape Length [TAPE30•45]
Select Button pg. 7
COUNTER R [Reset]/M [Memory]
Button pg. 29
- ⑭ EDIT Button pg. 30
- ⑮ DATE/TIME +/- Buttons pg. 6
CHAR. [Character] SET +/- Buttons pg. 22
TRACKING +/- Buttons pg. 29
- ⑯ DATE/TIME SET Button pg. 6
CHAR. SET Button pg. 22
R.A.EDIT IN/OUT Button pg. 32
- ⑰ R.A.EDIT Button pg. 32
- ⑱ REW Button pg. 28
RETAKE R [Quick Review] Button pg. 11
- ⑲ FF Button pg. 28
RETAKE F Button pg. 11
- ⑳ R.A.EDIT CANCEL Button pg. 32
- ㉑ STOP Button pg. 28
- ㉒ PLAY/PAUSE Button pg. 28
- ㉓ POWER Switch pg. 6
- ㉔ Recording Start/Stop Button pg. 8

Connectors

- ㉕ REMOTE Jack (For connection of the RM-V20U
wired remote control unit (optional).)
- ㉖ Shoulder Strap Eyelets pg. 8
- ㉗ EDIT Jack pg. 30
- ㉘ VIDEO Out Jack pg. 27
- ㉙ RF DC OUT Jack pg. 27
- ㉚ AUDIO Out Jack pg. 27

Indicators

- ㉛ Tally Lamp pg. 10
- ㉜ Power On Indicator pg. 10
- ㉝ LCD window (GR-AX460 only)

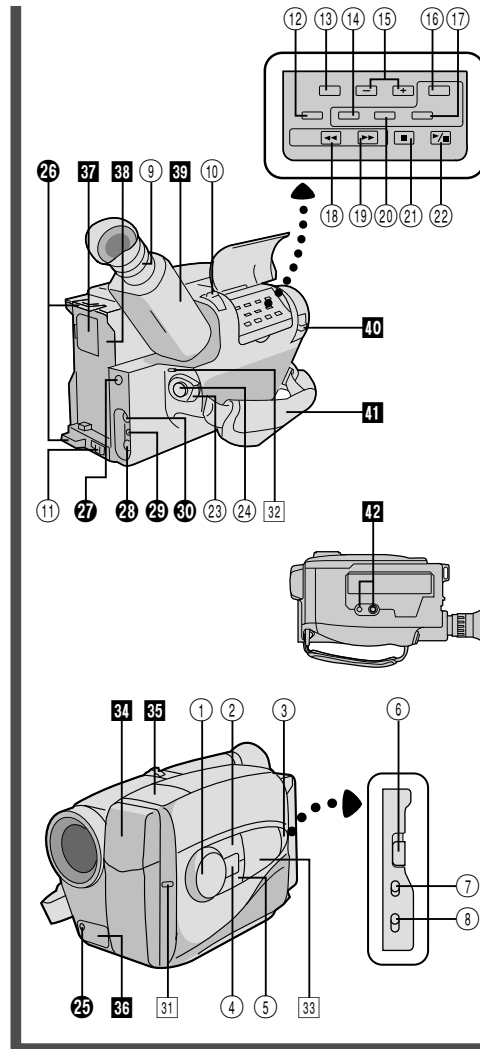

Other Parts

- ㉞ Video light (GR-AX460 only) pg. 13
- ㉟ Microphone
- ㊱ Remote Sensor pg. 9
(Be careful not to cover this area; built-in here is
the sensor necessary for shooting.)
- ㊲ Clock Battery Compartment pg. 6
- ㊳ Battery Pack Mount pg. 4
- ㊴ Electronic Viewfinder pg. 7
- ㊵ LENS COVER Switch pg. 10
- ㊶ Grip Strap pg. 8
- ㊷ Tripod Mounting Socket pg. 8



DANGER:

- The video light becomes extremely hot. Do not touch it either while in operation or soon after turning it off, otherwise serious injury may result.
- Do not place the camcorder into the carrying case immediately after using the video light, since it remains extremely hot.
- When operating, keep a distance of about 30 cm between the video light and people or object.
- Do not use near flammable or explosive materials.
- Consult your nearest JVC dealer for replacing the video light unit.

General Battery Precautions

- When the RM-V20U (remote control), C-P6U or C-P7U (cassette adapter) are not functioning even when correctly operated, the batteries are exhausted. Replace them with fresh ones.
- Use only the following batteries:
 RM-V20U R03 (AAA) size
 C-P6U or C-P7U R6 (AA) size

Please make note of the following rules for battery use. When misused, batteries can leak or explode.

1. Refer to the RM-V20U and C-P6U/C-P7U instructions when replacing batteries.
2. **Do not** use old and new batteries together.
3. **Do not** use two different kinds of batteries. Although sizes may be the same, voltages may differ.
4. **Do not** expose batteries to excessive heat as they can leak or explode.
5. **Do not** dispose of batteries in a fire.
6. Remove batteries from the unit if it is to be stored for an extended period to avoid battery leakage which can cause malfunctions.

Battery Packs

The supplied battery pack is a nickel-cadmium battery. Before using the supplied battery pack or an optional battery pack, be sure to read the following cautions:

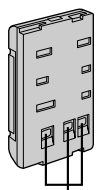

Terminals

1. **To avoid hazard . . .**
 - **do not** burn.
 - **do not** short-circuit the terminals.
 - **do not** modify or disassemble.
 - use only specified chargers.
2. **To prevent damage and prolong service life . . .**
 - **do not** subject to unnecessary shock.
 - avoid repeated charging without fully discharging.

- charge in an environment where temperatures are within the tolerances shown in the chart below. This is a chemical reaction type battery—cooler temperatures impede chemical reaction, while warmer temperatures can prevent complete charging.
- store in a cool, dry place. Extended exposure to high temperatures will increase natural discharge and shorten service life.
- avoid prolonged uncharged storage.
- remove from charger or powered unit when not in use, as some machines use current even when switched off.

3. To prevent damage to the camcorder . . .

- replace the battery pack when it begins to deliver less recording time per charge.

NOTE:

It is normal for the battery pack to be warm after charging, or after use.

Temperature Ranges

Charging	10°C to 35°C
Operation	0°C to 40°C
Storage	-10°C to 30°C

NOTES:

- *Recharging time is based on room temperature of 20°C.*
- *The lower the temperature, the longer recharging takes.*

Cassettes

To properly use and store your cassettes, be sure to read the following cautions:

1. During use . . .

- make sure the cassette bears the VHS-C mark.
- be aware that recording onto prerecorded tapes automatically erases the previously recorded video and audio signals.
- make sure the cassette is positioned properly when inserting.
- do not load and unload the cassette repeatedly without allowing the tape to run at all. This slackens the tape and can result in damage.
- do not open the front tape cover. This exposes the tape to fingerprints and dust.

2. Store cassettes . . .

- away from heaters or other heat sources.
- out of direct sunlight.
- where they won't be subject to unnecessary shock or vibration.
- where they won't be exposed to strong magnetic fields (such as those generated by motors, transformers or magnets).
- vertically, in their original cases.



Main Unit

1. For safety, DO NOT . . .

- open the camcorder's chassis.
- disassemble or modify the unit.
- short-circuit the terminals of the battery pack.
Keep it away from metallic objects when not in use.
- allow inflammables, water or metallic objects to enter the unit.
- remove the battery pack or disconnect the power supply while the power is on.
- leave the battery pack attached when the camcorder is not in use.

2. Avoid using the unit . . .

- in places subject to excessive humidity or dust.
- in places subject to soot or steam such as near a cooking stove.
- in places subject to excessive shock or vibration.
- near a television set.
- near appliances generating strong magnetic or electric fields (speakers, broadcasting antennas, etc.).
- in places subject to extremely high (over 40°C) or extremely low (under 0°C) temperatures.

3. DO NOT leave the unit . . .

- in places of over 50°C.
- in places where humidity is extremely low (below 35%) or extremely high (above 80%).
- in direct sunlight.
- in a closed car in summer.
- near a heater.

4. To protect the unit, DO NOT . . .

- allow it to become wet.
- drop the unit or strike it against hard objects.
- subject it to shock or excessive vibration during transportation.
- keep the lens directed at extremely bright objects for long periods.
- direct the eyepiece of the viewfinder at the sun.
- carry it by holding the viewfinder.
- swing it excessively when using the shoulder strap.

5. This camcorder features a built-in head cleaner which automatically cleans the heads and head drum when a cassette is loaded or unloaded. If, however, the heads become dirty and cause blurriness or interruption in the playback picture, consult your nearest JVC dealer.

About moisture condensation . . .

- You have observed that pouring a cold liquid into a glass will cause drops of water to form on the glass' outer surface. This same phenomenon occurs on the head drum of a camcorder when it is moved from a cool place to a warm place, after heating a cold room, under extremely humid conditions or in a place directly subjected to the cool air from an air conditioner.
- Moisture on the head drum can cause severe damage to the video tape, and can lead to internal damage to the camcorder itself.

Serious malfunctioning

If malfunctioning occurs, stop using the unit immediately and consult your local JVC dealer.

For Your Maintenance

1. After Use

- ① Set the power switch to POWER OFF to turn off the camcorder.
- ② Slide EJECT to open the cassette holder, then remove the cassette.
- ③ Close and lock the cassette holder by pressing PUSH.
- ④ Press BATT. RELEASE to remove the battery pack.
- ⑤ Slide the LENS COVER open/close switch to close the lens cover.

2. Cleaning The Camcorder

- ① **CLEAN EXTERIOR**
Wipe gently with a soft cloth.
- ② **CLEAN LENS**
Blow it with a blower brush, then wipe gently with lens cleaning paper.
- ③ **REMOVE EYEPIECE**
Turn the eyepiece counterclockwise and pull it out.
- ④ **CLEAN VIEWFINDER**
Remove dust using a blower brush.
- ⑤ **RE-ATTACH EYEPIECE**
Align the marks, re-attach the eyepiece and turn it clockwise.

NOTES:

- Avoid using strong cleaning agents such as benzine or alcohol.
- Cleaning should be done only after the battery pack has been removed or other power units have been disconnected.
- Mold may form if the lens is left dirty.



40

TROUBLESHOOTING

SYMPTOM	POSSIBLE CAUSE(S)
POWER	
No power is supplied.	<ul style="list-style-type: none"> • The battery pack has not been attached correctly (☞ pg. 4). • The battery pack is not charged (☞ pg. 4). • The power supply has not been correctly connected (☞ pg. 5).
RECORDING	
Recording cannot be performed.	<ul style="list-style-type: none"> • The recording tape's Erase Protection tab is missing. Cover the hole with adhesive tape. (Some tapes have sliding tabs. In this case, check the position of the tab.)
Recording does not start.	<ul style="list-style-type: none"> • The camcorder power switch has not been set to CAMERA (☞ pg. 10).
PLAYBACK	
The tape is running, but there's no playback picture.	<ul style="list-style-type: none"> • The TV has not been set to its VIDEO mode. • If A/V connection is used, the TV's VIDEO/TV switch has not been set to VIDEO. • The RF unit has not been set to the correct channel.
Noise bars appear in the playback picture.	<ul style="list-style-type: none"> • Manual Tracking has not been performed (☞ pg. 29).
Playback picture is blurred or interrupted.	<ul style="list-style-type: none"> • The video heads are dirty or worn out. Consult your nearest JVC dealer for head cleaning or replacement.
The counter indication is blurred during Still playback.	<ul style="list-style-type: none"> • This is normal.
TAPE TRANSPORT	
The tape stops during fast-forward or rewind.	<ul style="list-style-type: none"> • The Counter Memory Function has been activated (☞ pg. 29).
Rewinding or fast-forwarding cannot be performed.	<ul style="list-style-type: none"> • The tape is already fully wound on one reel or the other.
OTHER	
The tape won't eject.	<ul style="list-style-type: none"> • The battery pack is running low.
Some functions are not available.	<ul style="list-style-type: none"> • The PROGRAM AE dial is set to LOCK (☞ pg. 14).
Vertical white lines appear when shooting a very bright object.	<ul style="list-style-type: none"> • This sometimes occurs when the contrast between the background and the object is great. It is not a defect of the camcorder.
Bright, crystal-shaped spots appear in the viewfinder.	<ul style="list-style-type: none"> • Sunlight is directly entering the lens.
An error number (E01, etc.) appears in the viewfinder.	<ul style="list-style-type: none"> • Consult your nearest JVC dealer.

The camcorder is a microcomputer-controlled device. External noise and interference (from a TV, a radio, etc.) might prevent it from functioning properly. In such cases, first disconnect its power supply unit (battery pack, AC Power Adapter/Battery Charger, etc.) and clock battery; and then re-connect it and proceed as usual from the beginning.



SPECIFICATIONS

41

GENERAL

Format	: VHS PAL standard
Power source	: DC 6 V
Power consumption	
GR-AX460 light on	: 8.7 W
GR-AX460 light off	: 5.7 W
GR-AX360	: 5.9 W
GR-AX260	: 5.7 W
Signal system	: PAL-type
Video recording system	
Luminance	: FM recording
Colour	: Converted sub-carrier direct recording Conforms to VHS standard
Cassette	: cassette
Tape speed	: 23.39 mm/sec
Recording time	
Max.	: 45 minutes (with EC-45 cassette)
Operating temperature	: 0°C to +40°C
Operating humidity	: 35% to 80%
Storage temperature	: -20°C to +50°C
Weight	
GR-AX460	: Approx. 780 g
GR-AX360	: Approx. 750 g
GR-AX260	: Approx. 760 g
Dimensions	
GR-AX460/AX260	: 109 (W) x 113 (H) x 226 (D) mm
GR-AX360	: 109 (W) x 113 (H) x 206 (D) mm

CAMERA

Pick up	: 1/4" format CCD
Minimum required illumination	: 2 lx (F1.2)
Illumination range	: 2 to 100,000 lx
Lens	: F1.2, f = 4.1 to 57.4 mm, 14:1 power zoom lens with auto iris and macro control, filter diameter 46 mm
Viewfinder	: Electronic viewfinder with <ul style="list-style-type: none"> • 0.55" colour LCD (GR-AX360) • 0.5" black/white CRT (GR-AX460/AX260)
White balance adjustment	: Auto/Manual adjustment

VIDEO

Output	: 1 Vp-p, 75 ohms, unbalanced (via VIDEO out connector)
--------	---

AUDIO

Output	: -8 dBs, 1 k-ohm (via AUDIO out connector)
--------	---

AAC POWER ADAPTER/BATTERY CHARGER (AA-V11EG) SPECIFICATIONS

Power requirement	: AC 110 to 240 V \sim , 50/60 Hz
Power consumption	: 23 W
Output	: DC 8.5 V , 1.3 A (CHARGE), DC 6.3 V , 1.8 A (VTR)
Charging system	: Constant current, peak detection, timer controlled
Dimensions	: 150 (W) x 42 (H) x 68 (D) mm
Weight	: Approx. 350 g

CASSETTE ADAPTER (C-P7U) SPECIFICATIONS

Dimensions	: 188 (W) x 25 (H) x 104 (D) mm
Weight	: Approx. 240 g
Accessory	: "R6 (AA)"-size battery x 1

Provided Accessories **pg. 3**

Optional Accessories

- Battery Packs BN-V12U, BN-V22U, BN-V25U
- Car Battery Charger BH-V3E
- Battery Charger BH-VC10EG
- Car Battery Cord AP-V7E
- RF Unit RF-V5E
- Wireless Remote Control Unit RM-V704U
- Wired Remote Control Unit RM-V20U
- Compact VHS-C Cassettes EC-45/30
- Active Carrying Bag CB-V7U

* Some accessories are not available in some areas. Please consult your nearest JVC dealer for details on accessories and their availability.

E.&O.E. Design and specifications subject to change without notice.

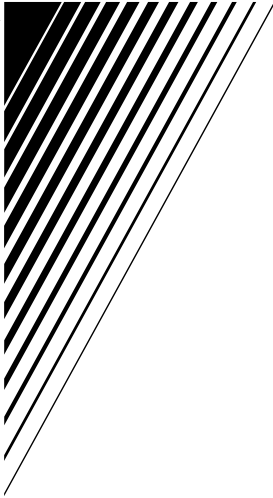

GR-AX460/AX360/AX260



JVC
VICTOR COMPANY OF JAPAN, LIMITED



COPYRIGHT© 1995 VICTOR COMPANY OF JAPAN, LTD.

EG  Printed in Japan
1295TOV*UN*YP

