

# HITACHI

Instruction Manual

## Hi8

8mm Video Camera/Recorder  
VM-H57A



**Hitachi Home Electronics (America), Inc.**  
3890 Steve Reynolds Blvd., Norcross, GA 30093  
Pointe Claire,  
Tel. 404-279-5600

**HITACHI (HSC) CANADA INC.**  
3300 Trans Canada Highway,

Quebec, H9R 1B1, CANADA  
Tel. 514-697-9150

**HITACHI SALES CORPORATION OF  
HAWAII, INC.**

3219 Koapaka Street, Honolulu, Hawaii 96819  
Tel. 808-836-3621

P4708922 © Hitachi, Ltd. 1993

E145554/E72118  
Printed in Japan KM-R(N)

**TABLE OF CONTENTS**

TABLE OF CONTENTS .....	2
For Your Safety .....	4
Read This First .....	6
Before You Begin.....	7
IMPORTANT SAFEGUARDS .....	7
IMPORTANT SAFETY INSTRUCTIONS FOR AC ADAPTER/CHARGER .....	12
Features .....	13
Components and Accessories.....	14
Getting Started.....	15
Charging the Battery .....	15
Additional Information .....	16
Adjusting the Electronic Viewfinder .....	18
Eyepiece Adjustment .....	18
Attaching the Shoulder Strap.....	18
Attaching the Optional Wide or Tele Converter Lens .....	20
Loading Batteries.....	20
Remote Control Battery .....	20
Camera/Recorder Battery .....	21
Removing the Battery .....	21
Checking the Battery's Charge.....	21
Using Alternative Power Sources .....	23
Using the AC Adapter/Charger.....	23
Using Alkaline Dry-Cell Batteries .....	23
Using a Car Battery .....	24
Inserting and Removing Cassettes.....	25
Inserting a Cassette .....	25
Removing a Cassette.....	25
Protecting Recorded Material .....	26
Attaching the Optional DC Camera Light .....	26
Removing the DC Camera Light .....	27
Replacing the DC Camera Light Bulb .....	27
Using Memory .....	28
Setting the Date and Time .....	29
Correcting the Date and Time .....	30
Automatic Date Recording .....	30
Using the Linear Time Counter .....	30
Remaining Tape .....	31
Using the Display Button .....	31
Getting Started - Identifying Controls.....	32
Basic Techniques.....	36
Making a Basic Recording .....	36
Playing Back Your Recording.....	37
Connecting to a Television with a VCR Attached.....	37
Connecting to a Television with Audio In and Video In Jacks.....	37

## TABLE OF CONTENTS

Connecting to a Television without Audio In and Video In Jacks .....	38
Simple Playback (Using the Electronic Viewfinder) .....	38
Using Still .....	38
Using Forward and Reverse Search .....	39
Advanced Techniques .....	39
Using the Power Zoom .....	40
Using the Digital Zoom .....	40
Using the INST. ZOOM (Instant Zoom) Button.....	41
Using Auto Focus .....	42
Using Manual Focus .....	43
Using the Electronic Image Stabilizer .....	44
Using Fade .....	45
Fading In .....	45
Fading Out.....	45
Using Instant Review .....	46
Using Quick Edit .....	46
Using Macro .....	46
Creating and Recording Titles.....	47
Creating a Title.....	47
Correcting Errors .....	48
Recording Title on a Tape in the Camera/Recorder .....	48
Recording a Title while Transferring a Tape .....	49
Using the Wireless Remote Control .....	50
Dubbing from the Camera/Recorder to a VCR.....	50
Using Synchro Edit.....	51
Controlling Your TV with the Camera/Recorder's Remote .....	52
Programming the Remote Control .....	52
Controlling the TV .....	53
Using Audio/Video Dubbing.....	54
Recording Television Programs .....	55
General Maintenance.....	55
Cleaning the Camera/Recorder Heads.....	55
Cleaning the Lens and Picture Tube of the Electronic Viewfinder .....	57
Periodic Maintenance .....	57
Troubleshooting .....	58
Specifications .....	61
Accessories Add Excitement.....	63
To Order in the United States.....	63

## For Your Safety

*The CAMERA/OFF/VIDEO switch turns the camera/recorder on and off, leaving the date/time feature unaffected. If the unit is to be left unattended for a long period of time, Turn the camera/recorder off and attach the lens cap.*

Illustrated below is the label on the bottom of your unit.



This symbol warns the user that uninsulated voltage within the unit may have sufficient magnitude to cause electrical shock. Therefore, it is dangerous to make any kind of contact with any inside part of this unit.



This symbol alerts the user that important literature concerning the operation and maintenance of this unit has been included. Therefore, it should be read carefully to avoid any problems.

**CAUTION:** TO REDUCE THE RISK OF ELECTRIC SHOCK, DO NOT OPEN.  
NO USER-SERVICEABLE PARTS INSIDE.  
REFER SERVICING TO QUALIFIED SERVICE PERSONNEL.

**WARNING:** Many television programs and films are copyrighted. In certain circumstances, copyright law may apply to private in-home videotaping of copyrighted materials.

**WARNING:** TO PREVENT FIRE OR ELECTRIC SHOCK, MATCH WIDE BLADE OF PLUG TO WIDE SLOT, AND FULLY INSERT PLUG.

This digital apparatus does not exceed the Class B limits for radio noise emissions from digital apparatus as set out in the Radio Interference regulations of the Canadian Department of Communications.

**Caution to the user:** Changes or modifications not expressly approved by the party responsible for compliance could void the user's authority to operate the equipment.

This camera/recorder can use 8mm and **Hi8** video cassettes. It automatically determines the loaded cassette is 8mm or and **Hi8** records and plays it back correctly.

**WARNING: TO PREVENT FIRE OR SHOCK HAZARD, DO NOT EXPOSE THIS UNIT TO RAIN OR MOISTURE.**

### MOISTURE

When the camera/recorder is exposed to rapid temperature changes from cold to warm, drops of moisture can form inside the mechanism. A flashing "DEW" indication in the viewfinder indicates that moisture has condensed on the recorder mechanism, which could result in tape damage. Since condensation builds up gradually, the indication does not appear immediately when condensation starts. When the temperature or humidity of the room changes abruptly, turn the power on and check that the "DEW" indication does not appear, then wait for about an hour for safety before using the camera/recorder. When the "DEW" indication in the viewfinder is flashing the unit will not operate. When this happens, slide the "EJECT" switch, remove the tape, and wait for the moisture to dry...the "DEW" indication in the viewfinder will stop flashing.

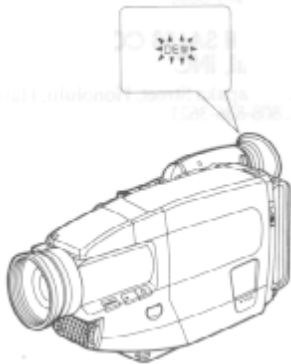

## Read This First

*Thank you for buying a Hitachi product. You've chosen the best 8 mm video camera/recorder for you, and we want to help you make the most of your purchase. Please take time to become familiar with the manual and how it is set up. Keep it handy for future reference.*

*To guide you, we've included:*

- A "Before You Begin" section containing important cautions for your family's safety as well as instruction for getting your video camera/recorder ready for use. Please read and understand this section thoroughly before moving on.
- A "Getting Started" section to familiarize yourself with the controls and prepare you for recording.
- A "Basic Techniques" section to allow you to use your video camera/recorder quickly and confidently before advancing to the more sophisticated features of the Hitachi VM-H57A.
- "Advanced Techniques" to help you with some of the exciting, sophisticated features of the Hitachi VM-H57A. We hope you will take the time to learn about these functions since they have been designed for you. You can use the video camera/recorder without reading this section.
- A "General Maintenance" section to help keep your purchase in good repair.

*We want this manual to be as helpful as possible, so it includes two easy ways to find the information you need:*

- A quick index for the information you use most often (this page).
  - A detailed table of contents directing you to specific information quickly (page 8).
- Get to know your video camera/recorder by using this manual, and get to know Hitachi. We appreciate your business.*

### **Quick Index**

Charging the Battery.....	10
Making a Basic Recording.....	24
Playing Back Your Recording.....	24
Using Power Zoom.....	30
Using Digital Zoom.....	30
Using the Wireless Remote Control.....	37
Dubbing from Camera/Recorder to VCR.....	38

---

## Before You Begin

Any problems that occur as a result of any of the following conditions will not be covered by our warranty.

Be careful that no water, dust or sand enters the camera/recorder.

When you shoot at a scene which contains an extremely bright object such as the sun or a light source, a bright vertical bar may appear in the picture.

Your camera/recorder is functioning properly, but the solid-state pickup device (CCD) usually causes this as an inherent characteristic. Try to avoid shooting an excessive bright object directly.

Be sure not to leave it in a place where the temperature exceeds 120° (49°C), or the pickup device may be damaged.

Dangerous includes:

- Inside a car with the windows closed and in direct sunshine.
- Near heating appliances.

Do not leave the viewfinder lens facing sunlight for a prolonged period, or the phosphorescent surface of the cathode ray tube may be damaged.

## IMPORTANT SAFEGUARDS

In addition to the careful attention devoted to quality standards in the manufacture of your video product, safety is a major factor in the design of every instrument. But, safety is your responsibility too.

This page lists important information that will help to assure your enjoyment and proper use of a Video Camera/Recorder and accessory equipment. Please read it carefully before operating your video product and keep it in a handy place for future reference.

## INSTALLATION

## IMPORTANT SAFEGUARDS

**1 Read and Follow Instructions** -- All the safety and operating instructions should be read before the video product is operated. Follow all operating and use instructions.



**2 Retain Instructions** -- The safety and operating instructions should be retained for future reference.

**3 Heed Warnings** -- Comply with all warnings on the video product and in the operating instructions.

**4 Polarized Plug** -- This video product is equipped with a polarized alternating-current line plug (a plug having one blade wider than the other). This plug will fit into the power outlet only one way. This is a safety feature. If you are unable to insert the plug fully into the outlet, try reversing the plug. If the plug should still fail to fit, contact your electrician to replace your obsolete outlet. To prevent electric shock do not use this polarized plug with an extension cord, receptacle or other outlet unless the blades can be fully inserted without blade exposure. If you need an extension, use a polarized cord.



**5 Power Sources** -- This video product should be operated only from the type of power source indicated on the marking label. If you are not sure of the type of power supply to your home, consult your video dealer or local power company. For video products intended to operate from battery power, or other sources, refer to the operating instructions.

**6 Overloading** -- Do not overload wall outlets and extension cords as this can result in a risk of fire or electric shock. Overloaded AC outlets and extension cords are dangerous, and so are frayed power cords, damaged or cracked wire insulation and broken plugs. They may result in a shock or fire hazard. Periodically examine the cord and have it replaced by your service technician if appearance indicates damage or deteriorated insulation.



**7 Power-Cord Protection** -- Power-supply cords should be routed so that they are not likely to be walked on or pinched by items placed upon or against them, paying particular attention to cords at plugs, convenience receptacles, and the point where they exit from the appliance.

**8 Ventilation** -- Slots and openings in the cabinet are provided for ventilation to ensure reliable operation of the video product and to protect it from overheating. These openings must not be blocked or covered. The openings should never be blocked by placing the video product on a bed, sofa, rug or other similar surface. This video product should never be placed near or over a radiator or heat register. This video product should not be placed in a built-in installation such as a bookcase or rack unless proper ventilation is provided or the video product manufacturer's instructions have been



## IMPORTANT SAFEGUARDS

followed.

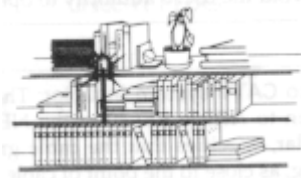

**9 Attachments** -- Do not use attachments unless recommended by the video product manufacturer as they may cause hazards.

**Caution:** Maintain electrical safety. Powerline operated equipment or accessories connected to this unit should bear the UL listing mark or CSA certification mark on the accessory itself and should not have been modified so as to defeat the safety features. This will help avoid any potential hazard from electric shock or fire. If in doubt, contact qualified service personnel.

**10 Water and Moisture** -- Do not use this video product near water - for example, near a bath tub, wash bowl, kitchen sink, or laundry tub, in a wet basement, or near a swimming pool, and the like.

**11 Accessories** -- Do not place this video product on an unstable card, stand, tripod, bracket, or table. The video product may fall, causing serious injury to a child or adult, and serious damage to the appliance. Use only with a cart, stand, tripod, bracket, or table recommended by the manufacturer, or sold with the video product. Any mounting of the product should follow the manufacturer's instructions, and should use a mounting accessory recommended by the manufacturer.

**11A** An appliance and cart combination should be moved with care. Quick stops, excessive force, and uneven surfaces may cause the appliance and cart combination to overturn.



**12 Outdoor Antenna Grounding** -- If an outside antenna or cable system is connected to the video product, be sure the antenna or cable system is grounded so as to provide some protection against voltage surges and built-up static charges. Section 810 of the National Electrical Code, ANSI/NFPA No. 70, provides information with respect to proper grounding of the mast and supporting structure, grounding of the lead-in wire to an antenna discharge unit, size of grounding conductors, location of antenna-discharge unit, connection to grounding electrodes, and requirements for the grounding electrode. See example below:

EXAMPLE OF ANTENNA GROUNDING

**13 Power Lines** -- An outside antenna system should not be located in the vicinity of overhead power lines or other electric light or power circuits, or where it can fall into such power lines or circuits. When installing an outside antenna system, extreme care should be taken to keep from touching or approaching such power lines or circuits as contact with them might be fatal. Installing an outdoor antenna can be hazardous and should be left to a professional antenna installer.

**USE**

**14 Cleaning** -- Unplug this video product from the wall outlet before cleaning. Do not use liquid cleaners or aerosol cleaners. Use a damp cloth for cleaning.

**15 Object and Liquid Entry** -- Never push objects of any kind into this video product through openings as they may touch dangerous voltage points or short-out parts that could result in a fire or electric shock. Never spill liquid of any kind on the video product.

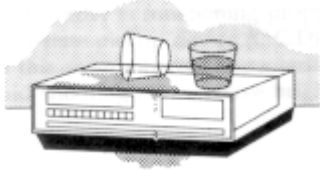

**16 Lightning** -- For added protection for this video product during a lightning storm, or when it is left unattended and unused for long periods of time, unplug it from the wall outlet and disconnect the antenna or cable-system. This will prevent damage to the video product due to lightning and power-line surges.

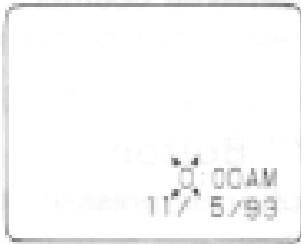

## SERVICE

**17 Servicing** -- Do not attempt to service this video product yourself as opening or removing covers may expose you to dangerous voltage or other hazards. Refer all servicing to qualified service personnel.

**18 Conditions Requiring Service** -- Unplug this video product from the wall outlet and refer servicing to qualified service personnel under the following conditions.

- a. When the power-supply cord or plug is damaged
- b. If liquid has been spilled, or objects have fallen into the video product.
- c. If the video product has been exposed to rain or water.
- d. If the video product does not operate normally by following the operating instructions. Adjust only those controls that are covered by the operating instructions. Improper adjustment of other controls may result in damage and will often require extensive work by a qualified technician to restore the video product to its normal operation.
- e. If the video product has been dropped or the cabinet has been damaged.
- f. When the video product exhibits a distinct change in performance - this indicates a need for service.

**19 Replacement Parts** -- When replacement parts are required, have the service technician verify that the replacements he uses have the same safety characteristics as the original parts. Use of replacements specified by the video product manufacturer can prevent fire, electric shock or other hazards.

**20 Safety Check** -- Upon completion of any service or repairs to this video product, ask the service technician to perform safety checks recommended by the manufacturer to determine that the video product is in safe operating condition.

**IMPORTANT SAFETY INSTRUCTIONS FOR AC ADAPTER/CHARGER**

1. Save these instructions -- This page contains important safety and operating instructions for AC Adapter/Charger Model VM-AC82A(R).
2. Before using AC Adapter/Charger, read all instructions and cautionary markings on (1) AC Adapter/Charger, (2) battery and (3) product using battery.
3. Also read all instructions on pages 4 and 5.

**4. Caution** -- To reduce risk of injury, charge only rechargeable battery, VM-BP82(G), VM-BP82 or VM-BP83.  
Other types of batteries may burst causing personal injury and damage.

5. Do not expose charger to rain or snow.
6. Use of an attachment nor recommended or sold by the battery charger manufacturer may result in a risk of fire, electric shock, or injury to persons.
7. To reduce risk of damage to electric plug and cord, pull by plug rather than cord when disconnecting charger.
8. Make sure cord is located so that it will not be stepped on, tripped over, or otherwise subjected to damage or stress.
9. Do not operate charger with damaged cord or plug - replace them immediately.
10. An extension cord should not be used unless absolutely necessary.  
Use of improper extension cord could result in a risk of fire and electric shock. If extension cord must be used, make sure:
  - A. The pins on plug of extension cord are the same number, size, and shape as those of plug on charger.
  - B. That extension cord is properly wired and in good electrical condition; and
  - C. That wire size should be met below:  
Minimum  
AWG size      Length of extension cord (feet)  
18              Equal to or less than 100  
16              Equal to or less than 150
11. Do not operate charger if it has received a sharp blow, been dropped, or otherwise damaged in any way; take it to a qualified serviceman.
12. Do not disassemble charger: take it to a qualified serviceman when service or repair is required. Incorrect reassembly may result in a risk of electric shock or fire.
13. To reduce risk of electric shock, unplug charger from outlet before attempting any maintenance or cleaning.

**"Note to CATV system installer:** This reminder is provided to call the CATV system installer's attention to Article 820-40 of the NEC that provides guidelines for proper grounding and, in particular, specifies that the cable ground shall be connected to the grounding system of the building, as close to the point of cable entry as practical".

**NOTES:**

- This unit uses **Hi8** video format cassettes.
- It records and plays back in the SP mode (14.3 mm/sec.).
- It cannot record and play back in the LP mode (7.2 mm/sec.).
- This camera/recorder uses a Hi-Fi stereo sound system. When a tape recorded by this camera/recorder is played by a conventional 8mm camera/recorder, monaural sound is output. When a tape recorded by a conventional 8mm camera/recorder is played by this machine, monaural sound is output.

**Features**

- **Hi8**
- Easy to use
- 16x zoom ratio
- Instant zoom
- Multi-function TV/Cam remote control
- Image stabilization

## Components and Accessories

Check that you have the following components and accessories before proceeding.

1. AV stereo output cord with S-VIDEO plug
2. Battery pack
3. AC adapter/charger
4. Remote control battery
5. Shoulder Strap
6. External power adapter
7. Remote control



## Getting Started

*This section guides you through the initial preparation of the camera/recorder. None of these processes are complex. Set aside some time, relax, and familiarize yourself with this quality instrument.*

*Enjoy getting to know all about your Hitachi 8mm camera/recorder. The more comfortable and familiar you are with the machine and its features, the more you can make it do for you. Let's get started!*

*It is crucial that you read and understand all the safety instructions before you begin. If you haven't read the safety instructions yet, please take the time to do so now.*

### Charging the Battery

*The first step is to set the battery to charge. It takes approximately an hour, enough time to familiarize yourself with some of the basic features of the camera/recorder. Once charged the battery will give you approximately 55 ~ 65 minutes of operating time depending on the use of ZOOM and Start/Stop.*

*Charge the battery at a temperature range of 50°F(10°C) - 86°F (30°C) to prevent damage to the battery.*

1. Plug the AC adapter/charger power cord into an AC outlet. Make sure that the wide blade fits into the wide slot. If it doesn't fit try reversing it. If you still cannot make fit the blades fully into the outlet either contact an electrician to replace your obsolete outlet, or use a polarized cord or outlet accessory.
2. To insert the battery into the charger align the reference arrow on the battery with the reference arrow on the AC adapter/charger. Push the battery till it is flush with the AC adapter/charger sliding it in the direction of the arrow as shown in the figure.
3. The CHARGE light remains on while the battery charges, turning off when charging completes.

**Note:** Remove the external power adapter from the AC adapter/charger before attempting to charge the battery. The CHARGE light flashes if the external power adapter remains connected while you attempt to charge the battery.

**Note:** Do not operate the battery at temperature below 14°F (-10°C) or above 95°F (35°C). At extremely low temperatures operation time decreases, while at high temperature the battery may be damaged.

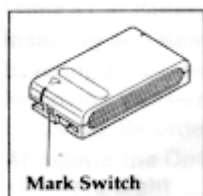

After charging set the mark switch to red so that you may quickly identify

whether the battery is charged or uncharged.

**Note:** The marker switch is not concerned with the battery's performance.

### Additional Information

To use a battery in optimum condition:

- Use the battery until the low charge light (  ) flashes. Using a battery for a short time and then recharging it may shorten the operation time.
- It is recommended to refresh a battery before recharging it when it has not been used for long time; otherwise its operation time becomes short. Press the refresh button. After refreshing is complete, the REFRESH light turns off and the CHARGE light turns on and charging begins automatically.

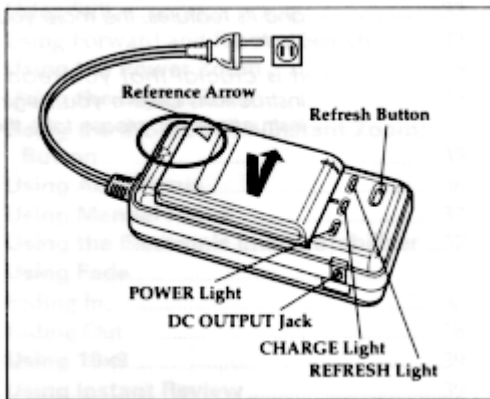

Refreshing a fully charged battery takes approximately 4 hours, adding considerable time to battery charging.

With repeated normal charging and use the battery will gradually lose operating time. When operation time becomes too short to be useful, replace the battery.

If the POWER light begins to flash during charging, remove the battery and then reattach it to the AC charger/adapter. If the POWER light continues to flash after several attempts to attach it, the battery is unable to take a charge and must be replaced. Do not attach a hot battery to the AC adapter/charger. Allow it to cool. Attaching a hot battery to the AC adapter/charger causes the POWER light to flash.

THERE ARE NO USER-SERVICEABLE PARTS INSIDE THE BATTERY OR AC ADAPTER/CHARGER.

THROWING THE BATTERY INTO FIRE OR EXPOSING IT TO EXCESSIVE HEAT (ABOVE 149°F (65°C)) MAY CAUSE INJURY.

SHORTING THE BATTERY'S TERMINAL INCREASES RISK OF FIRE OR ELECTRICAL SHOCK.



**ATTENTION:**



The product that you have purchased contains a rechargeable battery. The battery is recyclable. At the end of its useful life, under various state and local laws, it may be illegal to dispose of this battery into the municipal waste stream. Check with your local solid waste officials for details in your area for recycling options or proper disposal.

## Adjusting the Electronic Viewfinder

The electronic viewfinder adjusts simply by pivoting it to a position where it is comfortable and easy to see through. Place the viewfinder back in its original position before storing the camera/recorder in its case or carrying the camera recorder around to avoid damaging the viewfinder or camera/recorder.

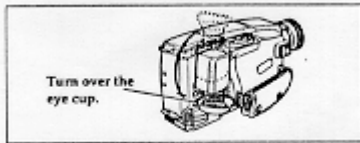

## Eyepiece Adjustment

To use the electronic viewfinder, pull out the eye cup all the way when using it and adjust the diopter control so that the subject is seen most clearly in the viewfinder. Always push in the eye cup after use.

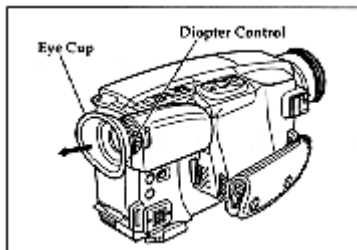

## Attaching the Shoulder Strap

Thread the ends of the provided shoulder strap through the slots at the back of the camera/recorder and thread through the shoulder straps' buckles. Please ensure that the straps are securely fastened before using the shoulder strap to carry the camera/recorder.

## Getting Started

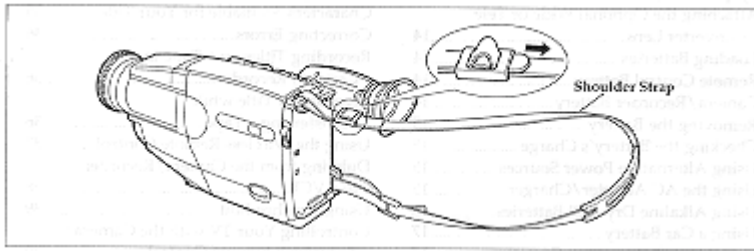

## Attaching the Optional Wide or Tele Converter Lens

1. To remove the lens hood, turn it counterclockwise.

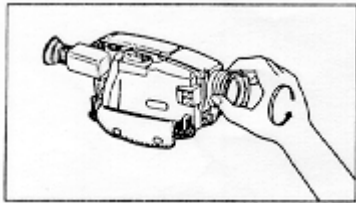

2. Remove both caps of the converter lens.
3. Screw the lens into the threads on the camera/recorder lens assembly.

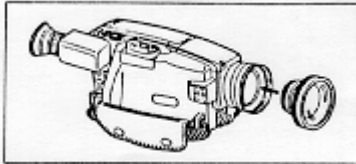

## Loading Batteries

*Install the remote control battery now to prevent misplacing it.*

### Remote Control Battery

1. Push the tab to the right of the remote control and hold it, then remove the battery holder.

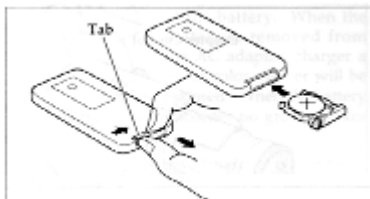

2. Press the PLAY button and hold it for about two seconds.
3. Insert the battery with the + facing in the direction of the open side of the battery holder.
4. Replace the battery holder with battery in the remote control making sure that it is full inserted.

**WARNING:** KEEP THE BATTERY AWAY FROM CHILDREN AND PETS.  
IF SWALLOWED CONSULT A PHYSICIAN IMMEDIATELY FOR EMERGENCY  
TREATMENT.

**Note:** Replace remote control battery with 3V micro lithium cells such as Maxell CR2025 or its equivalent.

**Note:** Dispose of battery safely in accordance with local laws. Do not dispose of in fire.

## Camera/Recorder Battery

Before you install the battery for the first time it must be fully charged. Refer to "Charging the Battery" for details.

1. Align the arrow on the battery with the guide arrow on the camera/recorder.
2. Hold the battery firmly against the camera/recorder while sliding it towards the right of the machine.

**Note:** Always remove the battery from the camera/recorder after use.

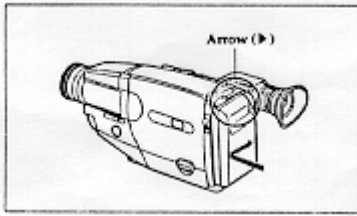

## Removing the Battery

Push the BATT EJECT switch in the direction of the arrow and hold it as you slide the battery toward the left of the camera/recorder and remove.

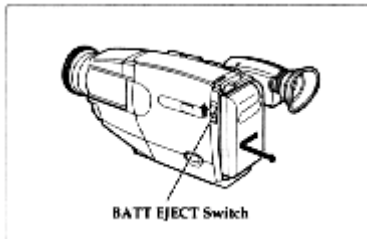

## Checking the Battery's Charge

A battery charge indicator is located on the upper right corner of the viewfinder. One of three symbols displays when the battery is used.

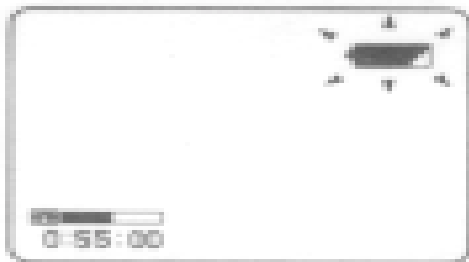

This symbol indicates a fully charged battery.



This symbol indicates a partially charged battery.

## Getting Started



This flashing symbol indicates a battery nearly out of power. Use an alternate power source or charge the battery before continuing to use the camera/recorder.

## Using Alternative Power Sources

### Using the AC Adapter/Charger

*Please ensure that the CAMERA/OFF/VIDEO switch is in the OFF position whenever attaching or detaching any power supply (ie. battery, AC adapter/charger, etc.)*

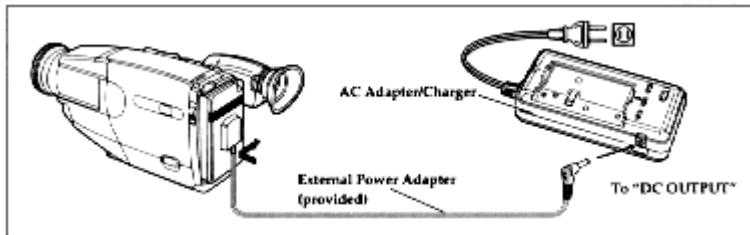

1. Plug the AC adapter/charger power cord into an AC outlet. Make sure that the wide blade fits into the wide slot. If it doesn't fit try reversing it. If you still cannot make fit the blades fully into the outlet either contact an electrician to replace your obsolete outlet, or use a polarized cord or outlet accessory.
2. Align the arrow on the external power adapter with the guide arrow on the camera/recorder.
3. Hold the external power adapter firmly against the camera/recorder while sliding it towards the right of the machine.
4. Connect the external power adapter plug to the DC OUTPUT jack of the AC adapter/charger.

**Note:** The AC adapter/charger can be used around the world. An AC plug adapter is required in some foreign countries. If you need one purchase it at your Hitachi distributor.

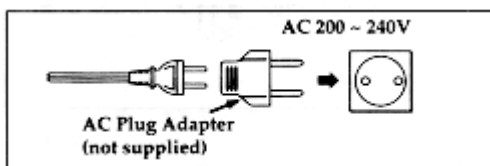

**Note:** The battery level indicator sometimes displays partial charge symbol when using the AC adaptor/charger. Ignore this indicator when using the AC adaptor/charger.

### Using Alkaline Dry-Cell Batteries

*The camera/recorder can be powered with six alkaline dry-cell batteries inserted into the optional battery case (Hitachi VM-BP86C) which can be attached to the camera/recorder. The operation time of the camera/recorder depends on the type of alkaline batteries used. Six special high-quality alkaline batteries can power the camera/recorder for about 50 minutes. Please ensure that the CAMERA/OFF/VIDEO*

## Getting Started

*switch is in the OFF position whenever attaching or detaching any power supply (ie. battery, AC adapter/charger, etc.)*

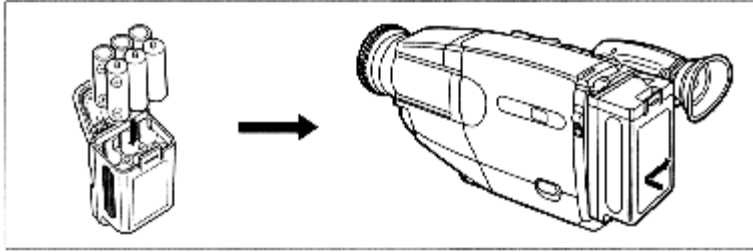

1. Insert six "AA" alkaline dry-cell batteries as shown, being sure not to confuse their polarity.
2. Align the arrow on the battery case with the guide arrow on the camera/recorder.
3. Hold the battery case firmly against the camera/recorder while sliding it towards the right of the machine.

**Note:** At extremely low temperatures operation time decreases, while at high temperatures these batteries may be damaged.

**Note:** Ordinary manganese batteries cannot be used.

**Note:** Attach the battery case immediately before you start recording.

## Using a Car Battery

*The camera/recorder can be powered with a car battery by using an optional car battery cord (Hitachi VM-CC80A) to plug the camera/recorder into the car's cigarette lighter socket. Please ensure that the CAMERA/OFF/VIDEO switch is in the OFF position whenever attaching or detaching any power supply (ie. battery, AC adapter/charger, etc).*

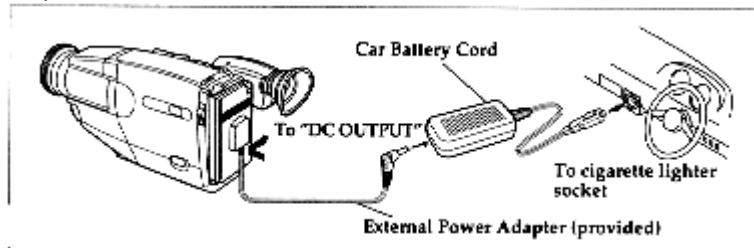

1. Plug the car battery cord into the car's cigarette lighter socket.
2. Align the arrow on the external power adapter with the guide arrow on the camera/recorder.
3. Hold the external power adapter firmly against the camera/recorder while sliding it toward the right of the machine.
4. Connect the external power adapter plug to the DC OUTPUT jack of the car battery cord.

**Note:** Only use the car battery cord with cars having 12/24 volt negative ground system.



## Inserting and Removing Cassettes

*A power source must be connected before inserting or removing cassettes. Once connected cassettes can be inserted or removed whether the CAMERA/OFF/VIDEO switch is on or off.*

### Inserting a Cassette

1. Slide the EJECT switch in the direction of the arrow. The cassette door opens automatically.
2. Place the cassette in the cassette holder so that the transparent window faces away from the body of the camera/recorder and the sprockets toward the body of the camera/recorder.

Characters available for your title.

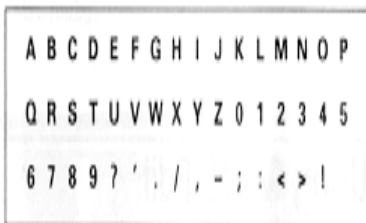

3. Push the cassette holder, which is embossed PUSH on the left hand side, until it "clicks" into place. The camera/recorder automatically closes.

**Caution:** Be sure that you push the cassette holder embossed PUSH to close the holder. Otherwise, the holder will not click into place and the tape may be slack which could lead to damage.

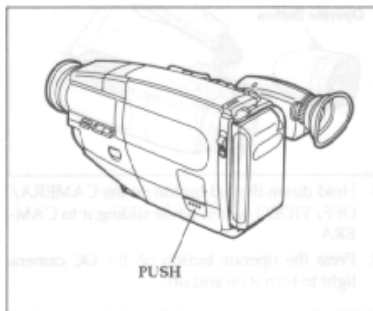

**Note:** If EJECT or TROUBLE flashes in the viewfinder, remove the cassette and check that the tape is not damaged, is not slack or no dust adheres to it, etc. After making sure that there is no abnormality, reinsert the cassette. If EJECT or TROUBLE reappears, see "Troubleshooting" on page 46.

### Removing a Cassette

Slide the EJECT switch in the direction of the arrow. The cassette door opens automatically. Remove the cassette.

## Protecting Recorded Material

Protect 8mm cassettes from accidental erasure by sliding the tab on the side of the cassette towards the opposite side until the tab is completely visible. Slide the tab in the opposite direction, until the tab disappears, to record on the cassette again.

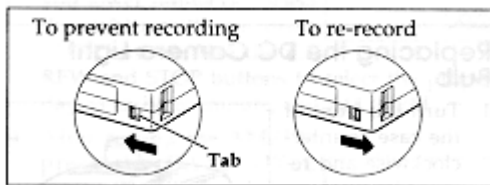

## Attaching the Optional DC Camera Light

*You can use the DC camera light to light subjects in darkened areas or correct unflattering shadows. Use the camera light wisely as it greatly reduces the time you may use a charged battery.*

NEVER TOUCH THE DC CAMERA  
LIGHT TERMINAL WHEN  
THE CAMERA/RECORDER IS TURNED ON TO  
AVOID ELECTRIC SHOCK.

1. Slide the CAMERA/OFF/VIDEO switch to OFF.
2. Connect a fully charged batteries or the AC adapter/charger ("Loading Batteries; Camera/Recorder Battery" p12, Using Alternative Power Sources" p13).
3. Slide the DC camera light onto the DC camera light shoe with the camera light lens facing the same direction as the camera/recorder's lens.

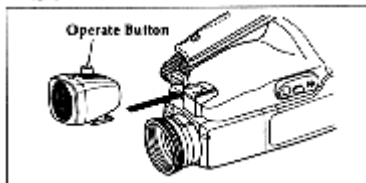

4. Hold down the red button on the CAMERA/OFF/VIDEO switch while sliding it to CAMERA.
5. Press the operate button on the DC camera light to turn it on and off.

### Notes when using the DC camera light:

- Keep the DC camera light away from splashing or dripping water.
- Never cover the DC camera light with paper, plastic or other object as the cooling vents may become blocked possibly causing the camera light to overheat.
- Never use the DC camera light in the vicinity of explosive or highly flammable materials.
- Always allow the DC camera light to cool fully before storing.
- The DC camera light becomes very hot during use of the camera light or immediately after use. Be careful that your hand or hair does not touch them.
- When the DC camera light is on, avoid subjecting the camera light to impacts or sharp vibrations.

## Getting Started

- If the DC camera light is turned on and off during recording, there could be noise in the picture. Watch the battery charge indicator especially when using a battery as the power source.
- When the DC camera light is used, the operation time of the camera/recorder when a fully-charged battery pack is attached is halved.

### Removing the DC Camera Light

Depress the light to release the tab from the hook and then move the light in the direction of the arrow as shown in the figure.

### Replacing the DC Camera Light Bulb

1. Turn the front of the case counter-clockwise and remove it.



2. Remove the bulb by pulling it out through the opened case.

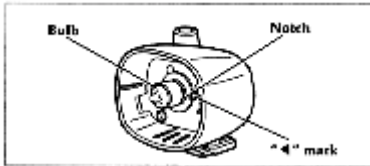

3. Install the new bulb by aligning the notch in the rim of the bulb's base with the "4" mark outside the socket. Avoid touching the bulb directly with your fingers. It may shorten the life of the bulb.
4. Reattach the front of the case by placing the bulb in the hole of the reflective plate, lining up the smaller "-" mark on the front of the cover with the "-" mark on the DC camera light, and turning the front of the cover clockwise till the larger "-" mark on the front of the cover aligns with the "-" mark on the DC camera light. Check that the front of the camera light is attached properly before turning the light on.

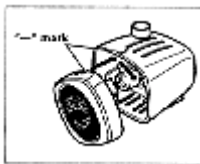

**Note:** Only replace the camera light bulb with VM-CP4L (optional) to reduce the risk of fire.

## Using Memory

*The linear time counter memory stops a rewinding tape at approximately 0:00:00M. This feature helps in locating a specific point in the tape to which you wish to return. An example might be that you have recorded some tape that you have already watched, you continue recording but do not care to watch the tape you recorded earlier. The memory feature returns you to the beginning of the most recent recording.*

1. Press the DISPLAY button on the remote control so the linear time counter with memory is displayed as shown in the figure.
2. Start recording or playback of a cassette. Press the COUNTER RESET button on the remote control at the point to which you wish to return. The linear time counter clears to 0:00:00M.
3. Continue recording or playback until ready to return. Press STOP when finished.
4. Press the REW/REVIEW button and the tape stops at approximately where you reset the linear time counter. This feature works in F.FWD as well.

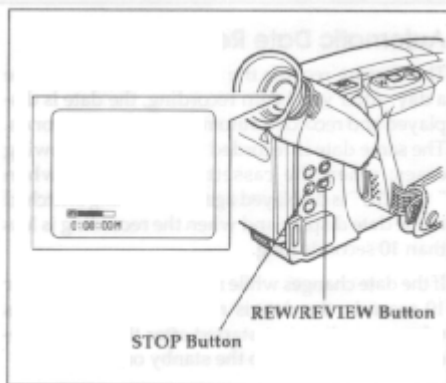

## Setting the Date and Time

*Take the time to set the date and time now: The time backup battery is rechargeable. Charge the backup battery every two months. Set the CAMERA/OFF/VIDEO switch to OFF and connect a charged battery or the AC adapter/charger to the camera/recorder for 24 hours. If you record the date and time at the beginning of each recording session they will serve as a handy reminder when viewing tapes at a later date. Make sure that the current time is displayed correctly before you start filming.*

**Note:** The backup battery should be charged every two months. If it is not charged periodically, it will be over-discharged and its life will be shortened.

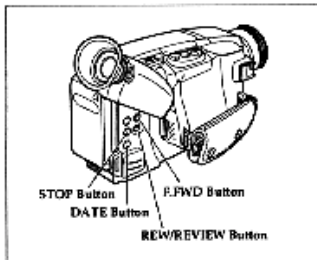

1. Load the battery ("Loading the Batteries: Camera/Recorder battery" p 12). Press the red button on the CAMERA/OFF/VIDEO switch as you slid it to CAMERA.
2. Press the DATE button and look into the viewfinder. The date and time should appear in the lower right with the "1" flashing.

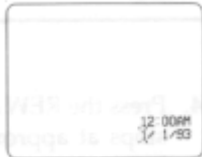

3. Pressing the F.FWD button gives you higher numbers while the REW/REVIEW button gives you lower numbers. Select the right month and press STOP button. Use the F.FWD, REW/REVIEW and STOP buttons to select the proper day, year, hour, minute, and AM or PM.



4. After setting the AM/PM, press the DATE button. The display changes and the internal clock starts.



**Note:** The date/time graphics will be recorded whenever they appear in the viewfinder.

## Correcting the Date and Time

1. Press the DATE button while pressing the stop button. The flashing cursor appears at the month.
2. Move to where you need to make the correction with the STOP button and use the F.FWD and REW/REVIEW to correct.
3. Press the DATE button to set the corrected date and time.

## Automatic Date Recording

This feature records the date automatically once a day. After you begin recording, the date is displayed and recorded automatically for 10 seconds. The same date is recorded again in the following cases; when the cassette is replaced, when " AUTO" is displayed again after being switched to the date display and when the recording is less than 10 seconds long.

If the date changes while recording continues over 10 seconds, the date is recorded for 10 seconds when recording is restarted after the camera/recorder has been set to the standby once.

Press the DATE button until " AUTO" and the date appear at the lower right of the viewfinder before you begin to record. The date will be recorded whenever it appears in the viewfinder.

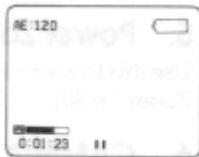

## Using the Linear Time Counter

*The linear time counter displays the tape run in hours, minutes, and seconds helping you to keep track of how long you've been filming or time you have left to film before running out of tape.*

Turn the camera/recorder on to display the linear time counter. The linear time counter keeps track from when you load a cassette into the camera/recorder and clears to 0:00:00 when the cassette is ejected.

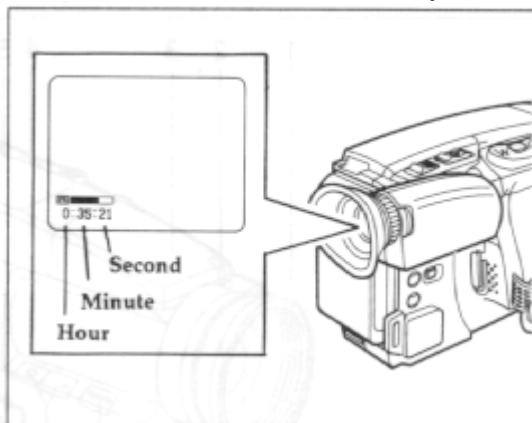

## Remaining Tape

The tape remaining display shows the remaining tape that can be used for recording and playback, using seven dashes. This feature is handy when recording since it lets you know how long you can record on the loaded tape.

Insert a cassette into the camera/recorder and start recording or playback; 10 seconds later, the remaining tape will be displayed. When the cassette is ejected, the display will disappear. " [RECORD] -----" is displayed for 10 seconds after the tape starts to run.

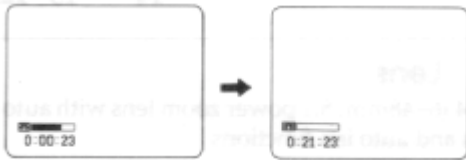

**Note:** The tape remaining display appears 10 seconds after the tape starts to run.

**Note:** When the remaining tape time becomes less than about three minutes, TAPE END flashes in the viewfinder.

## Using the Display Button

Pressing the DISPLAY button on the remote control allows you to switch the displays in the viewfinder. When the camera/recorder is turned on, the linear time counter appears.

- Pressing the DISPLAY button once displays the linear time counter with the memory feature.

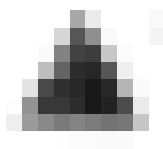

- Pressing the DISPLAY button a second time returns to the linear time counter.



**Note:** The linear time counter with the memory feature in the viewfinder can also be displayed on the connected television.

## Getting Started - Identifying Controls

Left side / Front Controls Illustration

### **1. Lens**

F1.4 (6~46mm) 8:1 power zoom lens with auto focus and auto iris functions.

### **2. Record Indicator**

This indicator lights when the camera/recorder is recording.

### **3. Infrared Receiver**

The area where infrared signals from the wireless remote are received. Aim the remote control to this area for best results.

### **4. INST. ZOOM (Instant Zoom) Button**

Use this button to magnify the image being recorded 1.5 times momentarily.

### **5. Power Zoom Switch**

Use this to zoom automatically ("Using the Power Zoom," p 30).

### **6. CAMERA/OFF/VIDEO Power Switch**

Hold down the red button as you slide the switch to CAMERA or VIDEO. You do not need to hold down the red button to slide the switch to OFF.

### **7. EJECT Switch**

A power source must be connected before cassettes can be inserted or removed though the CAMERA/OFF/VIDEO switch may be set to OFF ("Inserting and Removing Cassettes," p 15).

### **8. BATT EJECT (Battery Eject) Switch**

Slide this switch to remove the battery, battery case or external power adapter.

### **9. Cassette Holder Close Button**

**CAUTION:** Be sure to press this button to close the cassette holder. Otherwise, the tape may become slack and may be damaged.

### **10. Cassette Holder**

A power source must be connected to the camera/recorder before a cassette can be inserted or removed.



### **11. EIS (Electronic Image Stabilizer) Button**

EIS corrects slight shaking of an image ("Using the Electronic Image Stabilizer," p. 32).

### **12. FOCUS Control (AUTO/MAN) Buttons**

Press these buttons simultaneously to select manual or automatic focus. For manual focusing ("Using Manual Focus," p. 32), press the ► or ◀ button to bring the subject into focus. When using manual focus, appears in the viewfinder.

### **13. FADE Button**

The FADE button features three modes; white fade, wipe fade, and zoom fade ("Using Fade," p. 33).

Right side / Rear Illustration

### **14. Microphone**

### **15. PLAY Button**

Use to playback recorded tapes.

### **16. Power Supply Attachment**

The battery, battery case and external power adapter connect here ("Loading Batteries," p 12, "Using Alternative Power Sources," p 13)

### **17. Eye Cup**

Pull this cup all the way to see the image in the viewfinder. Return it to its original position when carrying the camera/recorder or storing it.

### **18. Diopter Control**

Use this control to focus the viewfinder.

### **19. F.FWD Button**

Use this button to fast forward tapes or for visual search. During visual search the camera/recorder fast forwards at approximately 9 times normal playback speed. Also use this button to set date and time.

### **20. Camera Light Shoe**

Attach the DC camera light here.

### **21. Hand Strap**

Refer to page 22.

### **22. Start/Stop Button**

When the CAMERA/OFF/VIDEO switch is in CAMERA press this button to start recording. When pressed a second time the camera pauses. During playback use this button to stop the tape temporarily. Pressing a second time resumes normal playback.

### **23. REW/REVIEW Button**

Use this button to fast rewind tapes or for visual search. During visual search the camcorder rewinds at approximately 7 times normal playback speed. Also use this button to set date and time. Furthermore, use this button to review the last few seconds of the tape you are recording.

#### **24. AV IN/OUT Jack (Behind the door)**

Use this jack to connect the camera/recorder to a VCR or television ("Playing Back Your Recordings," p 24, "Dubbing from the Camera/Recorder to a VCR," p 38 and "Recording Television Programs", P43).

#### **25. DATE Button**

Use this button to record the date and time on your tape. Any time that the date and time display is in the viewfinder they are recorded on your tape.

#### **26. STOP Button**

Use this button to stop playback, fast forward, or reverse. Also use this button to set date and time.

Bottom / Remote Illustration

#### **27. Tripod Mounting Threaded Socket**

Use this threaded socket to mount the camera/recorder to a tripod.

#### **28. TV Control Buttons**

Used for controlling the TV.

- POWER: Turns the TV on and off.
- AVX: Used for recording picture and sound from an auxiliary input (only with Hitachi TVs)
- VOLUME: Increase (▲) or decrease (▼) the volume.
- CHANNEL: Top (▲) button switches to next higher channel, bottom (▼) button switches to the next lower channel. For these to operate, you must have preset your channels.

("Controlling your TV with the Camera/Recorder" P40)

#### **29. Camera/Recorder Remote Control**

The shaded buttons on the remote control have the same functions as the corresponding buttons on the camera/recorder.

#### **30. S.EDIT (Synchro Edit) Button (only on the remote control)**

Use this button to activate the synchro edit function for dubbing. ("Using Synchro Edit", P39)

#### **31. COUNTER RESET Button (only on the remote control)**

Use this button to reset the linear time counter to 0:00:00.

#### **32. TITLE ON/OFF Button (only on the remote control)**

Use this button to create and record titles for your tapes ("Creating and Recording Titles," p 35).

**33. DISPLAY Button (only on the remote control)**

Use this button to select the viewfinder and TV display ("Using the Display Button," p 19).

**34. A/V DUB Button (only on the remote control)**

Use this button to record new audio and video over existing audio and video.

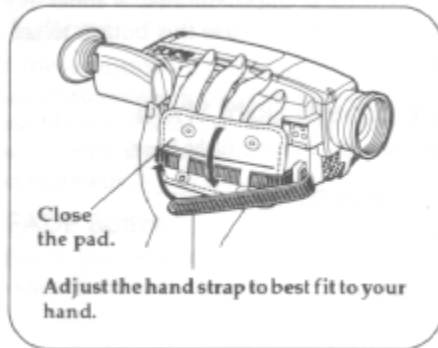

## Basic Techniques

*The batteries are in place and charged, the date and time are set, and you are familiar with the controls it's time to make a recording. Basic recording is easy and simple. Hooking up the camera/recorder to your TV is not complicated but give yourself plenty of time to ensure connections are correct. This section guides you through basic recording and playback. Practice the basic techniques of recording and playback on something unimportant such as traffic or a short tour of your backyard. Once familiar with how the machine works you can move to the more sophisticated features with less stress. Let's get started!*

### Making a Basic Recording

The Hitachi VM-H57A uses PROGRAM AE auto exposure that automatically selects the optimum shutter speed (either 1/60, 1/100, 1/120, 1/180, 1/250, 1/350, 1/500, 1/750, 1/1000, 1/1500, 1/2000, or 1/4000 of a second). The iris adjusts automatically in response to shutter speed.

1. Connect the camera/recorder to a power source ("Loading Batteries; Camera/Recorder Battery," p 12, "Using Alternative Power Sources," p 13).
2. Insert an 8mm cassette ("Inserting and Removing Cassettes," p 15).
3. Press the red button on the CAMERA/OFF/VIDEO switch as you slide it to CAMERA. **II** appears and the camera/recorder is now ready to record.

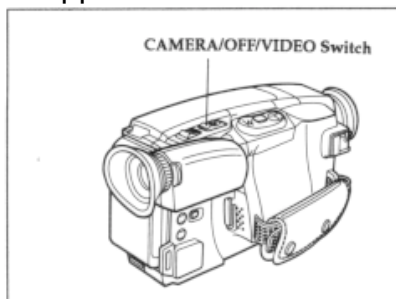

4. Use the diopter control to match the viewfinder's focus with your eyesight.
5. When you are ready to record press the Start/Stop button. **REC** appears in the viewfinder and the camera/recorder records the picture you see in the viewfinder.

**Note:** TAPE flashes in the viewfinder when the tab on the side of the cassette is completely visible.

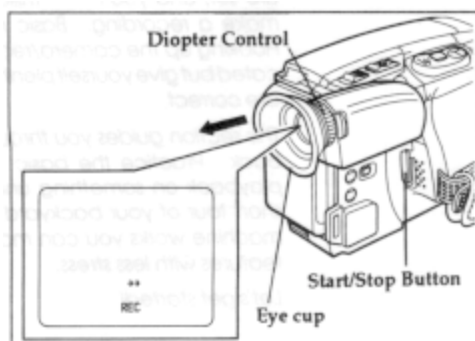

## Basic Techniques

6. To stop recording press the Start/Stop button and *REC* disappears from the viewfinder replaced by **■**. This places the camera/recorder in standby.

**Note:** TAPE END flashes in the viewfinder when about 3 minutes or less remain of the tape cassette.

**Note:** If the camera/recorder is left in record/pause mode for more than 5 minutes, the camera/recorder turns off automatically. To restart it press the Start/Stop button and the camera returns to record/pause mode.

## Playing Back Your Recording

*Depending on the setup of your video equipment, you connect the camera/recorder in one of the 3 methods explained below.*

### Connecting to a Television with a VCR Attached

1. Connect the provided AV output cord to the AUDIO IN and VIDEO IN jacks of your VCR.
2. Connect the free square plug to the AV IN/OUT jack of your camera/recorder.
3. Insert the previously recorded cassette into the camera/recorder.
4. Hold down the red button on the CAMERA/OFF/VIDEO switch while sliding the switch to VIDEO.

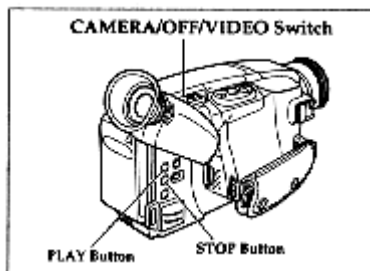

5. Press the PLAY button to begin playback.
6. Press the STOP button when finished.

### Connecting to a Television with Audio In and Video In Jacks

1. Connect the provided AV output cord to the AUDIO IN and VIDEO IN jacks of your television.
2. Connect the free square plug to the AV IN/OUT jack of your camera/recorder.
3. Turn on your television.
4. Insert the previously recorded cassette into the camera/recorder.
5. Hold down the red button on the CAMERA/OFF/VIDEO switch while sliding the switch to VIDEO.
6. Press the PLAY button to begin playback.
7. Press the STOP button when finished.

## Connecting to a Television without Audio In and Video In Jacks

1. Disconnect the VHF antenna leads from the back of the television. Leave the UHF antenna leads connected.
2. Connect the VHF antenna lead to ANT IN of the RF output adapter. If the cable on the VHF antenna lead is flat you need to purchase an antenna adapter (300-ohm to 75-ohm transformer). Connect the antenna adapter to the VHF antenna lead and slide the adapter on to the ANT IN terminal.
3. Connect the 75-ohm coaxial cable of the RF output adapter to the VHF antenna terminals on the back of the television. If the television is set up to connect to a flat antenna lead you need to purchase antenna adapter (75-ohm to 300-ohm transformer). Connect the adapter to the 75-ohm coaxial cable of the RF output adapter and connect the free ends of the adapter to the VHF antenna terminals at the back of your television.
4. Connect the RF output adapter cable to the AV IN/OUT jack of your camera/recorder.
5. Turn your television on and select channel 3 (channel 4 if channel 3 is a channel used in your area).
6. Select the CH3 or CH4 on the RF output adapter matching the channel selected on your television.
7. Insert the previously recorded cassette into the camera/recorder.
8. Hold down the red button on the CAMERA/OFF/VIDEO switch while sliding the switch to VIDEO.
9. Press the PLAY button to begin playback.
10. Press the STOP button when finished.

## Simple Playback (Using the Electronic Viewfinder)

1. Insert the cassette ("Inserting and Removing Cassettes," p 15).
2. Hold down the red button on the CAMERA/OFF/VIDEO switch while sliding the switch to VIDEO.
3. Press the PLAY button and enjoy your video.
4. Press the STOP button when finished.

## Using Still

To view a still picture during playback press the Start/Stop. Press the Start/Stop button again to resume playback. If you leave the camera/recorder in play/pause mode for more than 5 minutes the camera/recorder automatically stops the cassette to prevent damage to the tape.

**Note:** When you engage play/pause mode the still picture will have some interference or noise. This is normal.

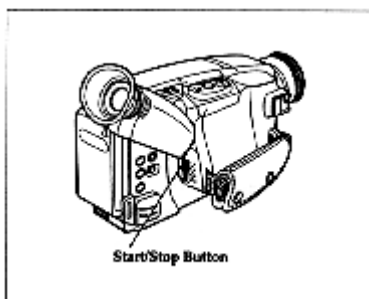

## Using Forward and Reverse Search

When looking for a particular point in your videotape use the F.FWD button and REW/REVIEW button to find the spot quickly.

- Press F.FWD button during playback to play the tape forward at approximately 9 times normal speed. Press PLAY button to return to normal playback.
- Press REW/REVIEW button during playback to play the tape backwards at approximately 7 times normal speed. Press PLAY button to return to normal playback.

**Note:** When you engage F.FWD button or REW/REVIEW button the picture will have some interference or noise. This is normal during search mode.

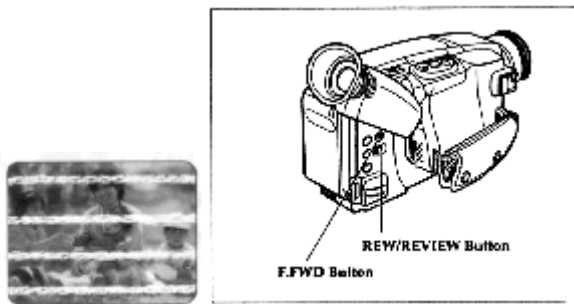

## Advanced Techniques

*The Hitachi VM-H57A offers a diverse group of features that add interest and excitement to your videos. Adding fades to smooth transitions creates videos with a professional look.*

*As you learn and practice with these features think of situations that they might fit in and add a special touch.*

## Using the Power Zoom

The power zoom W control widens the picture, moving the subject farther away, while the power zoom T control brings the subject closer, narrowing the picture. If appears at the left of the viewfinder, the digital zoom function shown below has been engaged.

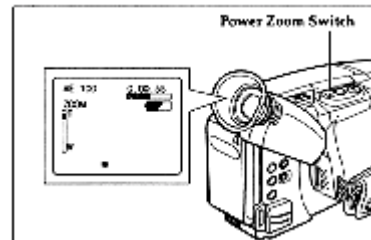

## Using the Digital Zoom

The digital zoom increases the magnification of the power zoom by 2 times. You must place the subject you wish to magnify at the center of the viewfinder.

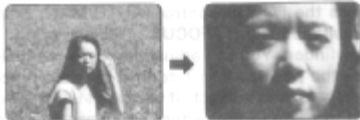

**Note:** When the digital zoom is used, the more the image is magnified, the rougher the picture becomes. Also even a slight shaking of the camera/recorder is conspicuous.

Press and hold the power zoom T control until you find the picture you want. You control the zoom with the power zoom T and W controls. When is not displayed in the viewfinder, normal zoom functions resume.

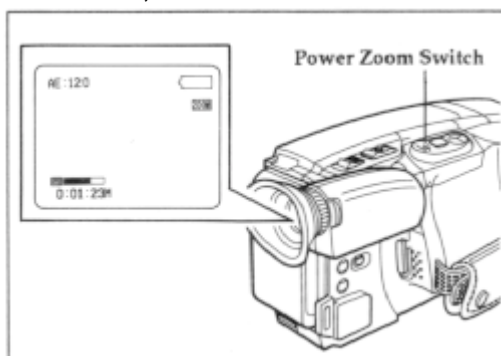



## Using the INST. ZOOM (Instant Zoom) Button

The instant zoom feature activates the digital zoom to magnify the subject 1.5 times regardless of zooming engaged by the power zoom T and W controls.

Press the INST. ZOOM button. appears at the left of the viewfinder and the picture is magnified 1.5 times momentarily.

**Note:** To return to the original zoom position, press the INST. ZOOM button so that disappears from the viewfinder.

**Note:** This instant zoom has certain limitations and may degrade at extreme magnification and amplify camera/recorder's movement.

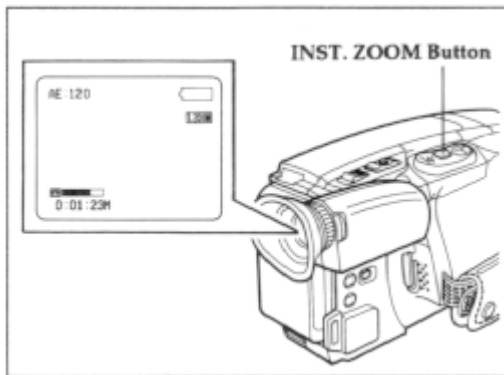

## Using Auto Focus

The camera/recorder focuses the subject in the center of the viewfinder automatically unless the manual focus is engaged. If appears in the viewfinder, manual focus is engaged. Press the FOCUS control (AUTO/MAN) buttons simultaneously to return to auto focus.

- The subject at the center of the viewfinder is in focus.



Good



No good

The auto focus will not work under the following conditions and you must focus manually:



Objects outside the center of the viewfinder

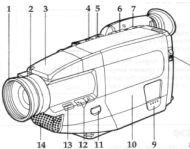

Objects at different distances in the center of the viewfinder



Brightly lit objects such as a neon light, objects lit by spotlight, etc.



Objects behind water dappled or dusty glass

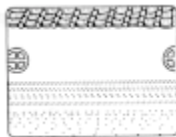

Objects with little difference in light reflection such as a white wall

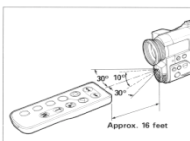

Rapidly moving objects



Dark objects

**Note:** With the T zoom control you can use the auto focus with subjects that are 3.6 feet away from the lens and further away to infinity. With the W zoom control you can use the auto focus with subjects 1.2 inches away from the lens and further away to infinity.

## Using Manual Focus

1. Press the FOCUS control (AUTO/MAN) buttons simultaneously. displays in the viewfinder. You can adjust the focus manually.
2. Use the power zoom T control to zoom up completely to your subject. If you don't use the T control to zoom to the picture you want, the picture may fall out of focus when actual recording starts.
3. Press the Focus control (AUTO/MAN) ◀ or ▶ button until the subject is in focus.
4. Use the power zoom W control to zoom back to the picture you desire.

**Note:** To return to auto focus press FOCUS control (AUTO/MAN) buttons and the disappears from the viewfinder.

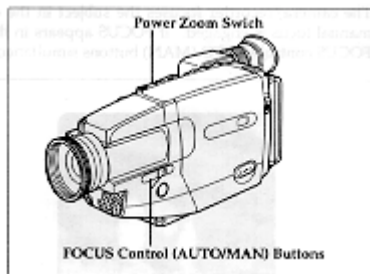

## Using the Electronic Image Stabilizer



The electronic image stabilizer (EIS) corrects slight shaking of the image being recorded and is effective in the following situations.

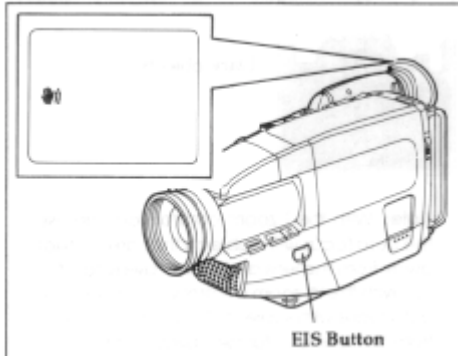

- While you zoom to a distant subject.
  - While you approach a small subject.
  - While you walk around.
  - While you record from inside a moving vehicle.
1. Press the EIS button. The EIS icon appears in the viewfinder.
  2. Press the Start/Stop button to start recording. When EIS is engaged the viewfinder image shakes with a slight delay.

**Note:** EIS may not function you use a wide or teleconverter lens.

**Note:** When the EIS function is engaged in the vicinity of the zoom range with displayed in the viewfinder, when moved from the wide-angle end, the image size will change, but this is normal.

**Note:** When the EIS function is engaged, the picture becomes rough.

**Note:** When the EIS function is engaged, the angle of view at the wide-angle end becomes narrower.

## Using Fade

Use the fade feature to add a professional touch to your recordings. Use the FADE button to select one of the three fade options.

- White fade: Fades in from a white screen or fades out to a white screen.  appears in the upper left corner of the viewfinder.

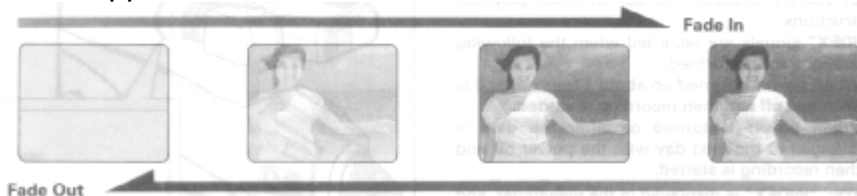

- Wipe fade: The picture opens gradually from the center of a black screen or closes into the center to a black screen.  appears in the upper left corner of the viewfinder.

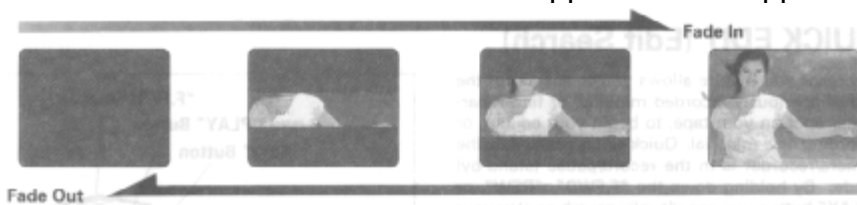

- Zoom fade: Fades in while zooming from a white screen or fades out while zooming to a white screen.  appears in the upper left corner of the viewfinder.

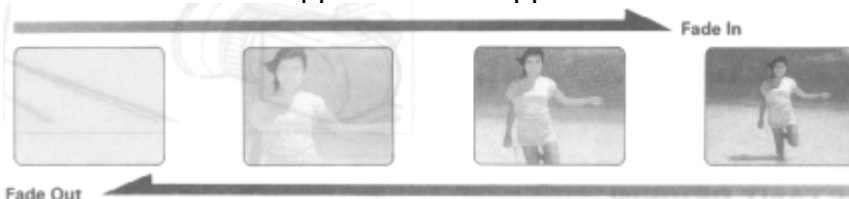

### Fading In

1. Use the FADE button to select a fade option before recording.
2. Press the Start/Stop button to start recording; fade begins automatically.

### Fading Out

1. While recording with the camera/recorder use the FADE button to select a fade option.
2. Press the Start/Stop button to stop recording; the fade begins automatically and REC flashes until the fade ends.

**Note:** When fading out be sure to wait until the PAUSE indicator () is visible in the viewfinder before attempting to put the camera/recorder into the record mode again.

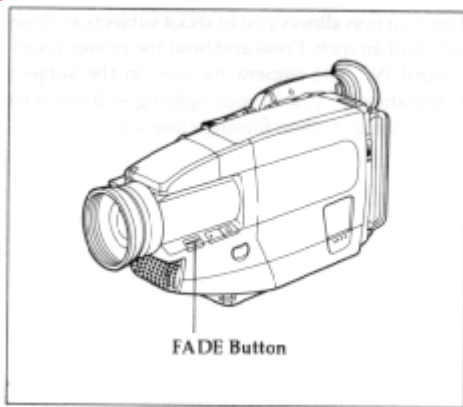

## Using Instant Review

Use this feature to view the last few seconds of the tape you shot.

1. Set the camera/recorder to record/pause mode and tap the REW/REVIEW button. The last few seconds of tape play back in reverse and then in normal playback mode.
2. The camera plays back to the spot where you paused and returns to record/pause mode (standby). Press the Start/Stop button to resume recording.

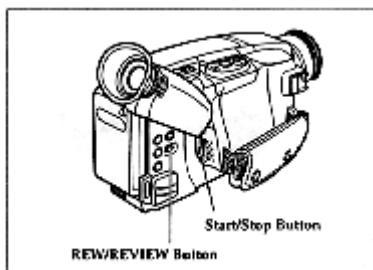

## Using Quick Edit

Use quick edit to search for the end of previously recorded material, find a particular spot on your tape, begin editing, or record new material. While the camera is in record/pause mode hold down the F.FWD, REW/REVIEW, or PLAY button and visually search the tape. Release the button and the camera/recorder stops the tape at the exact position you selected.

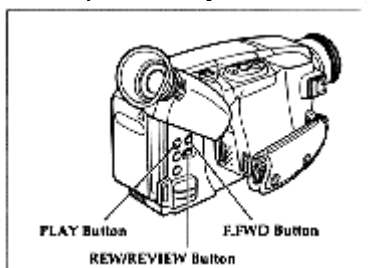

## Using Macro

## Advanced Techniques

This function allows you to shoot subjects as close as 3/8 of an inch. Press and hold the power zoom control W. The camera focuses on the subject automatically. Check your lighting as it tends to be insufficient when filming close up.

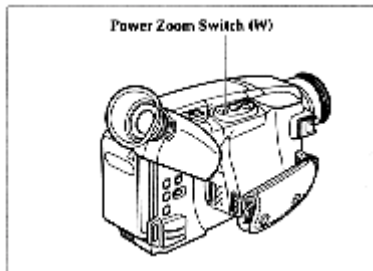

## Creating and Recording Titles

*Create titles easily and personalize your recordings while keeping a permanent visual record of what is contained on a tape. The camera/recorder can store 2 different titles in its memory. A title stored in memory can be displayed and recorded at any time. A title contains two lines of up to 16 characters per line. The camera/recorder contains 47 different characters for creating a title.*

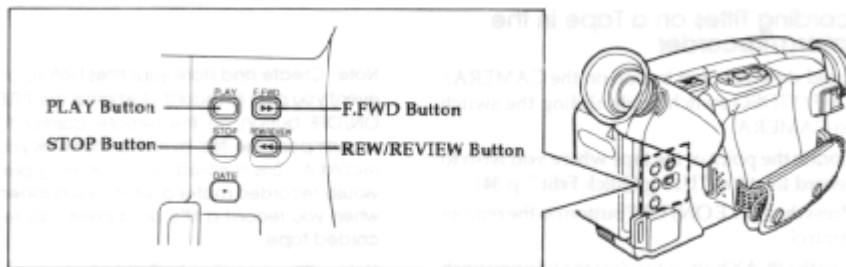

### Creating a Title

1. Connect the camera/recorder to a power source.
2. Hold down the red button on the CAMERA/OFF/VIDEO switch and slide it to either CAMERA or VIDEO.
3. Press the TITLE ON/OFF button on the remote control and a flashing cursor appears in the viewfinder.

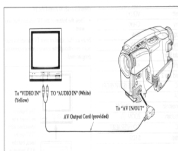

4. Use the STOP button to place the cursor where you wish to begin your title.
5. Use the F.FWD and REW/REVIEW buttons to select the first character of your title.

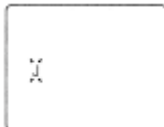

## Advanced Techniques

Characters available for your title.

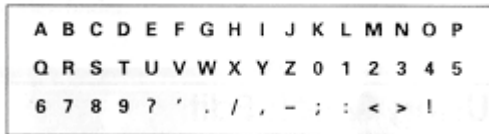

6. Once you've selected a character press the STOP button to set it.

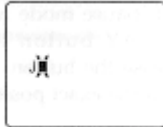

7. Complete the title by repeating steps 5 and 6.

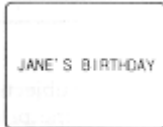

8. When you complete your title, press PLAY to create a second title as required, or press the TITLE ON/OFF button on the remote control to store the title in memory and remove the title graphics from the viewfinder.

**Note:** As long as the correct current time can be displayed, the title is held in memory.

### Correcting Errors

1. Press the TITLE ON/OFF button on the remote control.
2. Select the title with the PLAY button.
3. Use the STOP button to select the character to be corrected.
4. Use the F.FWD and REW/REVIEW buttons to correct the character.
5. Press the TITLE ON/OFF button on the remote control to store the corrected title in memory.

### Recording Title on a Tape in the Camera/Recorder

1. Hold down the red button on the CAMERA/OFF/VIDEO switch while sliding the switch to CAMERA.
2. Locate the point of the tape where you wish to record the title ("Using Quick Edit," p 34).
3. Press the TITLE ON/OFF button on the remote control.
4. Use the PLAY button to select the title you wish to record.
5. Press the Start/Stop button to start recording the title.
6. Press the TITLE ON/OFF button on the remote control to stop recording the title. The title graphics disappear from the viewfinder and the camera/recorder can record normally.

**Note:** Create and store your title before an event you plan to record. Just press the TITLE ON/OFF button on the remote control to superimpose the title over the scene as you record it. This method avoids erasing previously recorded material which will happen when you record a title on a previously recorded tape.

**Note:** Title recording is disabled when you connect the optional AV input cable to the AV IN/OUT jack to record video and audio from the television or VCR.



### Recording a Title while Transferring a Tape

1. Connect the camera/recorder to the VCR (p 24).
2. Press the TITLE ON/OFF button on the remote control to turn title on.
3. Use the PLAY button to select a title from memory.
4. Press the TITLE ON/OFF button on the remote control to turn title off.
5. Turn on the VCR and set it to record. Hold down the red button on the CAMERA/OFF/VIDEO switch while sliding the switch to VIDEO. Press PLAY on the camera/recorder.
6. Press the TITLE ON/OFF button on the remote control at the point on the tape where you wish to record the title.
7. Press the TITLE ON/OFF button on the remote control again to stop recording the title.

**Note:** Recording the title during tape transfer will erase a portion of your recorded material.

## Using the Wireless Remote Control

*Use the wireless remote control to operate the camera/recorder from a distance. The PLAY, F.FWD, REW, STOP, PAUSE (START/STOP) and ZOOM buttons on the wireless remote control operate the functions of the corresponding buttons on the camera/recorder. Aim the wireless remote control at the infrared ray receiver of the camera recorder.*

Wireless Remote Control Range/Angle

**Note:** Use the wireless remote control within the range of the infrared ray receiver of the camera/recorder shown above.

**Note:** The wireless remote control may not function in strong light such as direct sunlight or very bright artificial lighting.

**Note:** Clear a direct path from the wireless remote control to the infrared ray receiver. The wireless remote control won't work if an obstacle blocks the infrared rays.

**Note:** The remote control code of this camera/recorder is Hitachi code VCR2. If you have a VCR with the same code you Hitachi VCR may malfunction when you use the camera/recorder's wireless remote control.

## Dubbing from the Camera/Recorder to a VCR

Connect the camera/recorder to a VCR to copy your or a friend's home 8mm recordings to VHS.

Dubbing Diagram

1. Connect the AV output cord plug to the AV IN/OUT jack of your camera/recorder.
2. Connect the AV output cord to the AUDIO IN and VIDEO IN jacks of your VCR.
3. Hold down the red button of the CAMERA/OFF/VIDEO switch while you slide the switch to VIDEO.
4. Insert the recorded tape in the camera/recorder and a blank tape into the VCR. Set the VCR to record.
5. Play the tape from the camera/recorder while recording on the VCR.

**Note:** If the VCR is connected to a television and the VCR/TV selector is set to VCR, you can monitor the tape being dubbed.

## Using Synchro Edit

Use synchro edit to record only segments of a previously recorded tape when dubbing from the camera/recorder to a VCR. This requires an optional synchro edit cord. The Hitachi VM-H57A uses a flying erase head to eliminate glitches or rainbow noise that sometimes occurs between edits. Your VCR must have the EDIT IN jack to use the synchro edit.

### Synchro Edit Diagram

1. Connect the synchro edit cord to the AV IN/OUT jack of your camera/recorder.
2. Connect the synchro edit cord to the AUDIO IN, VIDEO IN, and EDIT IN jacks of your VCR. Connect either the right or left audio plug into your VCR if it has only one AUDIO IN jack.
3. Insert the recorded tape in the camera/recorder and a blank tape into the VCR.
4. Play the tape in the camera/recorder until you find the place you want to record. Press the Start/Stop button.
5. Press the RECORD button on the VCR. It automatically sets to pause. If the VCR begins to record instead of pausing you need to change the position of the switch on the synchro edit cord. Stop the VCR, change the position of the switch, and press the RECORD button on the VCR.
6. Press the S.EDIT button on the remote control and the last few seconds of the recorded tape reviews in the viewfinder and then the camera/recorder is placed in playback. The recording VCR starts recording automatically.
7. Press the F.FWD, REW/REVIEW, STOP and Start/Stop buttons to pause the VCR. You can then search forward or back through the tape, fast forward, or rewind the tape without affecting the tape in the VCR. Use the F.FWD and REW/REVIEW buttons to search the tape. Press the PLAY button to resume normal playback. To resume recording on the tape in the VCR, press the Start/Stop button and then the S.EDIT button. To fast forward or rewind the tape, press the STOP button, then F.FWD or REW/REVIEW. To return to recording on the tape in the VCR, press the STOP button, then the PLAY button, then the Start/Stop button, and then the S.EDIT button.
8. To stop recording at a certain point turn on the camera/recorder's linear time counter with memory ("Using Memory," p 17). Press the COUNTER RESET button on the remote control where you wish the recording to stop. The linear time counter resets to 0:00:00M. Rewind to the point where you wish to start recording and start copying. When the linear time counter reaches 0:00:00 the recording stops automatically, pausing the VCR in the record mode.

**Note:** If the tape counter reads "0:00:00M" you cannot start recording.

## Controlling Your TV with the Camera/Recorder's Remote

*The remote control is designed to be compatible with many televisions, but will not work with every one made. If your TV does not respond the way it should when you program it as explained below, this remote may be incapable of operating it. Once you have programmed the remote, you won't have to do it again until you change the batteries.*

This remote control can be used with your TV as well as the camera/recorder, as long as your TV comes with a remote control. This feature comes in handy -- you don't have to juggle two remotes.

The remote control is compatible with the fourteen makers of TVs listed below -- but don't be alarmed if yours is not on our list. You may still be able to program the remote for your TV.

Every TV that comes with a remote control is set up to detect certain infrared signals. You need to program the camera/recorder remote control to send signals that your TV will recognize and respond to. Here's what to do:

### Programming the Remote Control

- Turn the television on (any channel is okay).
- Aim the camera/recorder's remote control at your TV set. Hold down the CH (▲) button while you press the button corresponding to your brand of television as shown in the chart (page 41).

For example, if you have an RCA television, press CH (▲) and DISPLAY at the same time. If this button combination sends a signal that matches with your TV, the channel will change on the TV, and you'll know the remote is set to control the television.

- If that button combination does not change the TV channel, go through the whole list of button combinations one by one until you find one that does change your TV channel. Also, if your brand of TV is not listed in the chart, try all the buttons. One of them may work for you.

If the TV channel still doesn't change after going through all the button combinations listed, it is likely that you will not be able to program this remote control for your TV.

### TV Brands Press CH (▲) and This Button

Hitachi	AVX
Zenith	VOL (▼)
Sony	CH (▼)
Magnavox	REW
Sanyo	PLAY
Gold Star 1	F.FWD
Toshiba	AV DUB
Gold Star 2	STOP

---

## Advanced Techniques

NEC	PAUSE (START/STOP)
RCA	DISPLAY
Panasonic	TITLE ON/OFF
Mitsubishi	ZOOM.(T)
JVC	COUNTER RESET
Sharp	S.EDIT

---

### Controlling the TV

Once programmed, the camera/recorder's remote control is ready to control the TV.

- Press the button of the TV function that you want.

Be aware that not all of your TV's functions may work even though the remote control is correctly programmed.

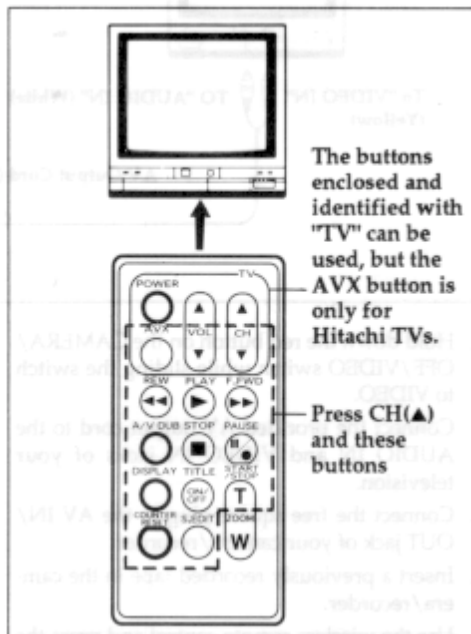

**Note:** The AVX Button can only be used with Hitachi TVs.

**Note:** It may not be possible to control all TVs listed in this Table.

## Using Audio/Video Dubbing

Use audio/video dubbing to record audio and video from the camera/recorder's built-in microphone and camera onto a previously recorded tape in the camera/recorder.

Audio/Video Dubbing Diagram

1. Hold down the red button on the CAMERA/OFF/VIDEO switch while sliding the switch to VIDEO.
2. Connect the provided AV output cord to the AUDIO IN and VIDEO IN jacks of your television.
3. Connect the free square plug to the AV IN/OUT jack of your camera/recorder.
4. Insert a previously recorded tape in the camera/recorder.
5. Use the wireless remote control and press the PLAY button. Use the PLAY, F.FWD, and REW buttons to find the place where you want to stop dubbing. Press the PAUSE (START/STOP) button.
6. Display the linear timer counter with memory ("Using Memory," p 17). Press the COUNTER RESET button to set the linear time counter to 0:00:00M.
7. Use the REW and PLAY buttons to find where you wish to start dubbing. Press the PAUSE (START/STOP) button.
8. Press and hold the A/V DUB button while pressing the PLAY button. This places the camera/recorder in A/V DUB pause mode.
9. Press the PAUSE (START/STOP) button. The audio/video dubbing starts. When the linear time counter reaches 0:00:00M the camera/recorder stops automatically, recording only the portion of the tape that you selected.

Remote Control Buttons

**Note:** If the camera/recorder is in AV DUB pause or STILL mode for more than 5 minutes, the camera/recorder stops automatically to protect the tape.

**Note:** Automatic date recording is disabled during audio/video dubbing.

**Note:** When the audio/video dubbed portion is played back, noise may appear at the end of the dubbed portion.

## Recording Television Programs

If your television or VCR has AUDIO OUT and VIDEO OUT jacks you can record television programs with your camera/recorder.

Recording TV Diagram

1. Connect the camera/recorder to a power source.
2. Insert a cassette in the camera/recorder.
3. Hold down the red button on the CAMERA/OFF/VIDEO switch while sliding the switch to CAMERA.
4. Connect the optional AV input cord to the VIDEO OUT and AUDIO OUT jacks of your television.
5. Connect the free plug to the AV IN/OUT jack of your camera/recorder.
6. Turn your television or VCR on and tune it to the channel you wish to record from.
7. Press the Start/Stop button to start recording the program that is on the screen of the television.
8. Press the Start/Stop button again to stop recording.

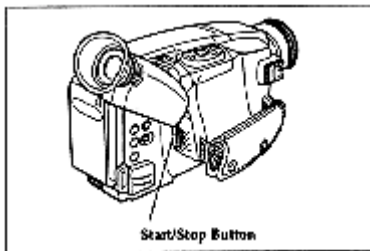

**Note:** If the tape is played back while the AV input cord is left connected to the camera/recorder, noise may appear in the picture. In this event, press the STOP button to stop the camera/recorder, unplug the AV input cord and play back the tape again.

**Note:** To monitor the picture being recorded, connect the AV output cord (provided) to the VIDEO IN jack of the television as shown above.

## Cleaning the Camera/Recorder Heads

Dirt can accumulate on the video heads on the camera causing the playback picture to become blurred or appear as if video information is lost. This often means that the video heads are dirty. Use a video head cleaner such as Maxell 8M-CLT to clean the heads. If after cleaning the heads the picture does not clear up consult your nearest dealer or

General Maintenance

VCR service center for professional head cleaning.

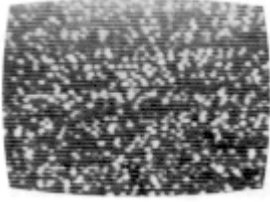



## Cleaning the Lens and Picture Tube of the Electronic Viewfinder

The lens of the electronic viewfinder can be user-cleaned if dust, dirt, or other foreign matter adheres to it.

Cleaning the Lens Illustration

1. Pull out the eye cup to the position where a mark can be seen (up to a half where it is pulled out all the way). The side with the mark should be up.
2. Turn the eye cup counterclockwise until it stops, then pull it out to remove.
3. Clean the picture tube face and lens. To prevent scratching, use a soft non abrasive cloth, swab or lens cleaning paper.
4. Face the rib up as shown above and push and the eye cup in until it stops.
5. Turn the eye cup clockwise until it stops, the push it in all the way.

## Periodic Maintenance

A precision electromechanical device, the Hitachi VM-H57A requires maintenance after a period of normal use. We expect that no other maintenance other than head cleaning will be required during the period of warranty unless the camera/recorder is used either heavily or seldom. Defective parts are covered by the warranty. Normal maintenance is the responsibility of the owner. Consult your dealer or local VCR service center for recommendations regarding normal maintenance based on your use patterns, location, and the age of the camera/recorder.

## Troubleshooting

Quality is very important at Hitachi. We inspect and check every camera/recorder carefully at the factory under the most rigid quality control and inspection systems. If problems develop please check the following possible solutions before inquiring

<b>INSERTING OR REMOVING THE CASSETTE</b>	
<b>Symptom</b>	<b>Check Point &amp; Correction</b>
Cassette holder cannot be opened when you slide "EJECT" button	Connect the power source.
Cassette cannot be inserted into cassette compartment.	Load cassette in direction indicated by arrow on cassette.
	Cassette window must be toward outside.

<b>CAMERA RECORDING</b>	
<b>Symptom</b>	<b>Check Point &amp; Correction</b>
Picture does not appear in the viewfinder.	Remove the lens cap.
	Slide the power switch to "CAMERA"
	Disconnect the AV input cable from the camera/recorder.
The camera/recorder cannot go into the recording mode, even when the start/stop button is pressed.	Check the record protect tab on the cassette.
	Make sure that the "FOCUS M" does not appear in the viewfinder. If it is displayed, press "Focus" select button to erase it.
Picture is out of focus.	Auto-Focus does not operate if a special effects filter is attached.

<b>RECORDING TV PROGRAMS OFF THE AIR</b>	
<b>Symptom</b>	<b>Check Point &amp; Correction</b>
The camera/recorder can not be set to the recording mode, even when the start/sop button on the camera/recorder is pressed.	Check the record protect tab on the cassette.
	Set the power switch to "CAMERA" position.
	Connect the camera/recorder and TV (or VCR).

**General Maintenance****General Maintenance (cont.)**

<b>PLAYBACK OF PRE-RECORDED CASSETTE</b>	
<b>Symptom</b>	<b>Check Point &amp; Correction</b>
"PLAY" button cannot be engaged.	Set the power switch to "VIDEO" position.
No picture appears on television screen when "PLAY" button is pressed.	Set the television to the camera/recorder channel (3 or 4) depending upon the selected channel in the RF channel select switch of RF output adapter. (TV is connect to the camera/recorder by using RF output adapter.)
Interference on playback picture.	When you see the playback picture on yourTV, adjust fine tuning knob on television set to obtain best picture.
Picture bends at the top of the TV screen.	TV receiver is older type. It needs to be modified to work properly with camera/recorder.
	Tape is damaged, try another cassette.
Color of your TV screen is too bright, too faint or change.	TV set has VIR circuit. Turn off during playback.

**DEW**

<b>Symptom</b>	<b>Check Point &amp; Correction</b>
"DEW" indication flashes in the viewfinder.	Condensation on the camera/recorder mechanism – wait until the unit has reached normal room temperature and condensation has dried. "DEW" indication will then stop flashing.

**BATTERY CONDITION**

<b>Symptom</b>	<b>Check Point &amp; Correction</b>
The "  " indication in the electronic viewfinder	Try another battery or charge the battery.

**NO OPERATION IS ACCEPTED**

<b>Symptom</b>	<b>Check Point &amp; Correction</b>
Power is not turned on an no button operations are accepted.	Remove the power source, and after about one minute, push the reset switch gently using a toothpick, etc. until you feel a click. The display will be reset. Then set the information again.

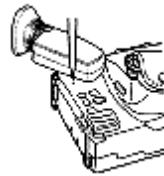

EJECT OR TROUBLE DISPLAY	
Symptom	Check Point & Correction
EJECT or TROUBLE appears in the viewfinder.	Remove the cassette and then try to reinsert, remove it several times. If the indication is still shown in the viewfinder, use a cleaning tape to clean the heads and replace the cassette.

## Specifications

### General Specifications

Power requirements	6V DC
Power consumption	5.9W (when recording)
Dimensions	3-9/16" W x 4-9/16" H x 8-1/16" D (91mm x 116mm x 205mm)
Weight	1.6 lbs (730g) without battery pack, lens hood, lens cap or cassette
Operating temperature	32°F ~ 104°F
Storage temperature	-4°F ~ 140°F

### Video Recorder Specifications

Format	8mm
Record/playback	Two video record/playback heads
Video signal	EIA standard NTSC color
Tape speed	14.3mm/sec
Video input	1.0Vp-p, 75 ohm
Video output	1.0Vp-p, 75 ohm
Audio input	-7.8dBs (316mVrms)
Audio output	-7.8dBs (316mVrms)
Fast forward/rewind time	Less than 8 minutes with P6-120 cassette

### Camera Specifications

Scanning	525 lines/60 fields/30 frames
Required minimum illumination	1 lux
Pickup device	1/3" C.C.D.
Lens diameter	34mm

For U.S.A. only

### HITACHI

Service Hotline

To locate an authorized  
HITACHI service facility  
in the continental U.S.A.

### DIAL TOLL FREE

7 days a week, 24 hours a day

800 HITACHI

1-800-448-2244

### Hitachi Home Electronics (America), Inc.

Hitachi has made every effort to assure you hours of trouble free operation from your unit. However, should you require service, a network of Hitachi Authorized Service Facilities has been established in all 50 states and Puerto Rico. Each facility will provide you with convenient and expedient assistance. Our service "Hotline" operator will direct you to the Hitachi Authorized Service Facility nearest you. Just present proof of purchase and/or delivery receipts to the Hitachi Authorized Service Facility and service will be rendered in accordance with the terms of the limited warranty as stated on your

Specifications

warranty card or operating guide.

---

***Should you have any questions regarding in-warranty service, operation or technical assistance, please contact:***

**Hitachi Home Electronics (America), Inc.**

3890 Steve Reynolds Blvd  
Norcross, GA 30093  
Tel 404-279-5600

**Hitachi Sales Corporation of Hawaii**

3219 Koapaka St./Honolulu, HI 96819  
Tel 808-836-3621

## Accessories Add Excitement

*We know that once you discover how much your Hitachi VM-H57A can add to your life you will want to use these accessories for even more excitement. Converter lenses, adapters for synchro editing, and car cords are just a few of the exciting accessories available to you from Hitachi. Hitachi takes you to wherever your imagination leads.*

### To Order in the United States

#### **By Phone**

To place an order by phone, have your VISA, MASTERCARD, or AMERICAN EXPRESS card ready and call Hitachi's toll-free number anytime: 24 hours a day, 7 days a week.

**1-800-HITACHI**

#### **By Mail**

**Hitachi Home Electronics (America), Inc.  
Parts Division  
401 West Artesia Blvd.  
Compton, CA 90220**