

HITACHI

Instruction Manual

8

8mm Video Camcorder

VM-E535LA / VM-E635LA

**HITACHI HOME ELECTRONICS (AMERICA),
Inc.**

3890 Steve Reynolds Blvd., Norcross, GA 30093
Tel. 770-279-5600

HITACHI (HSC) CANADA INC.

6740 Campobello Road
Mississauga, Ontario, L5N 2L8
CANADA
Tel. 905-821-4545

**HITACHI SALES CORPORATION OF
HAWAII, INC**

3219 Koapaka Street, Honolulu, Hawaii 96819
Tel. 808-836-3621

Thank you for buying a Hitachi product. Please take time to become familiar with the manual and how it is set up. Keep it handy for feature reference.

QR17263 © Hitachi, Ltd. 1997

Printed in Japan NR-S(N)

IMPORTANT SAFETY INFORMATION	5
For Your Safety.....	5
Important Safeguards	6
IMPORTANT SAFETY INSTRUCTIONS FOR AC ADAPTER/CHARGER	10
Before You Begin	10
Read This First.....	11
Quick Index.....	11
Features	12
Getting Started.....	13
Components and Accessories.....	13
Optional RF Adapter	13
Identifying Controls.....	14
Loading Clock and Remote Control Batteries.....	17
Clock Battery	17
Remote Control Batteries.....	18
Charging the Battery	19
Charging Time.....	19
Operating Time	19
Camcorder Batteries	20
Using Battery Pack.....	20
Removing the Battery Pack	21
Checking the Battery's Charge.....	21
Using Alternative Power Sources	21
Using the AC Adapter/Charger.....	21
Using a Car Battery.....	22
Inserting and Removing Cassettes.....	22
Inserting a Cassette	22
Removing a Cassette.....	23
Protecting Recorded Material	23
LCD Monitor	24
Opening the LCD Monitor	24
Adjusting the Brightness of the LCD Screen.....	24
Range in which the LCD Monitor can be moved.....	24
Adjusting the Electronic Viewfinder	25
Eyepiece Adjustment	26
Adjustment the Hand Strap.....	26
Lens Door Opener.....	27
Attaching the Shoulder Strap.....	27
Using the Linear Time Counter	27
Remaining Tape	28
Setting the Date and Time	28
Correcting the Date and Time	29
Basic Techniques.....	30

Making a Basic Recording	30
Using Instant Review	31
Using Auto Focus	31
Using Manual Focus	33
Using the Power Zoom	33
Using the Digital Zoom	33
Using the INST. ZOOM (Instant Zoom) Button.....	34
Using Macro	34
Active Screen	35
Playback.....	35
Simple Playback (Using the Electronic Viewfinder or LCD monitor).....	36
Using Still	36
Using Forward and Reverse Search	36
Playing Back Your Recording on Your TV	37
Connecting to a Television with a VCR Attached.....	37
Connecting to a Television with Audio In and Video In Jacks.....	38
Connecting to a Television without Audio In and Video In Jacks	39
Advanced Techniques	40
Changing the Angle of the LCD Monitor when Recording.....	40
Recording an Image of Yourself while Monitoring the LCD Screen.....	40
Date Recording	41
Digital Effects Recording	43
16x9 Mode Recording.....	44
Negative/Positive Recording.....	45
X130 Digital Zoom Recording.....	45
Half-Mirror Recording.....	45
Mosaic Recording.....	46
Using Fade	46
Fading In	47
Fading Out.....	47
Using the Electronic Image Stabilizer (only for VM-E635LA).....	47
Using Quick Edit	48
Using the Display Button	48
Date Search.....	49
Using Memory	50
Using the Wireless Remote Control	50
Attaching the Optional Wide or Tele Converter Lens	51
Creating and Recording A Title	51
Creating a Title.....	52
Correcting Errors	52
Recording Title on a Tape in the Camcorder	53
Recording a Created Title while Transferring a Tape.....	53
Dubbing from the Camcorder to a VCR.....	53
Simple Programmable Edit (Edit remote control is optional accessory).....	54
Programming the Remote Control for the VCR	54
Operation	56
To End Programmable Simple Edit	58
Using Audio/Video Dubbing.....	58
General Maintenance.....	60
Cleaning the Camcorder Heads.....	60

Cleaning the Lens and Picture Tube of the Electronic Viewfinder	60
Periodic Maintenance	61
Troubleshooting	61
Specifications	64
General Specifications.....	64
Video Recorder Specifications	64
Camera Specifications.....	64
Available Accessories.....	65
To Order in the United States.....	65
By Phone	65
By Mail.....	65
FOR AUTHORIZED HITACHI SERVICE IN CANADA.....	65

IMPORTANT SAFETY INFORMATION

For Your Safety

The CAM/OFF/VIDEO switch turns the camcorder on and off, leaving the date/time feature unaffected. If the unit is to be left unattended for a long period of time, turn the camcorder off and close the lens door.

WARNING: TO PREVENT FIRE OR SHOCK HAZARD, DO NOT EXPOSE THIS UNIT TO RAIN OR MOISTURE.

The camcorder and AC adapter/charger have the following caution marks.



Identifications of caution marks



This symbol warns the user that uninsulated voltage within the unit may have sufficient magnitude to cause electrical shock. Therefore, it is dangerous to make any kind of contact with any inside part of this unit.



This symbol alerts the user that important literature concerning the operation and maintenance of this unit has been included. Therefore, it should be read carefully to avoid any problems.

WARNING: Many television programs and films are copyrighted. In certain circumstances, copyright law may apply to private in-home videotaping of copyrighted materials.

This Class B digital apparatus meets all requirements of the Canadian Interference-Causing Equipment Regulations.

CAUTION: TO REDUCE THE RISK OF ELECTRIC SHOCK, DO NOT OPEN.
NO USER-SERVICEABLE PARTS INSIDE.
REFER SERVICING TO QUALIFIED SERVICE PERSONNEL.

WARNING: TO PREVENT FIRE OR ELECTRIC SHOCK, MATCH WIDE BLADE OF PLUG TO WIDE SLOT, AND FULLY INSERT PLUG.

The liquid crystal display (LCD) panel is made by highly precise technology. More than 99.99% of its picture elements (pixels) are effective, but some (less than 0.01%) may appear as colored bright dots. This does not indicate a fault as the LCD panel stretches

IMPORTANT SAFETY INFORMATION

the limits of current technology.

Warning: This device complies with Part 15 of the FCC Rules. Operation is subject to the following two conditions: (1) This device may not cause harmful interference, and (2) this device must accept any interference received, including interference that may cause undesired operation.

Note: This equipment has been tested and found to comply with the limits for a Class B digital device, pursuant of Part 15 of the FCC Rules. These limits are designed to provide reasonable protection against harmful interference in a residential installation. This equipment generates, uses, and can radiate radio frequency energy and, if not installed and used in accordance with the instructions, may cause harmful interference to radio communications. However, there is no guarantee that interference will not occur in a particular installation. If this equipment does cause harmful interference to radio or television reception, which can be determined by turning the equipment off and on, the user is encouraged to try to correct by one or more of the following measures:

- Reorient or relocate the receiving antenna.
- Increase the separation between the equipment and receiver.
- Connect the equipment into an outlet on a circuit different from that to which the receiver is connected.
- Consult the dealer or an experienced radio/TV technician for help.

Caution to the user: Changes or modifications not expressly approved by the manufacture could void the user's authority to operate the equipment.

"Note to CATV system installer: This reminder is provided to call the CATV system installer's attention to Article 820-40 of the NEC that provides guidelines for proper grounding and, in particular, specifies that the cable ground shall be connected to the grounding system of the building, as close to the point of cable entry as practical".

Notes:

- This unit uses 8mm video format cassettes.
- It records and plays back in the SP mode (14.3 mm/sec).
- It cannot record and play back in the LP mode (7.2 mm/sec).

MOISTURE

Avoid operating your camcorder immediately after moving it from a cold place to a warm, humid place. Give the camcorder 2 to 3 hours to stabilize in the ambient conditions of the surroundings before inserting a cassette. When moved from a cold place to a warm, humid place, moisture may condense on the head drum inside the machine. This moisture could cause the tape to stick to the headwheel and damage the headwheel or tape.

When a small amount of moisture is sensed, "TAPE" flashes in the viewfinder or LCD monitor. Remove the cassette and set the CAM/OFF/VIDEO switch to OFF, then wait for about one hour.

Important Safeguards

In addition to the careful attention devoted to quality standards in the manufacture of your video product, safety is a major factor in the design of every instrument. But,

IMPORTANT SAFETY INFORMATION

safety is your responsibility too.

This page lists important information that will help to assure your enjoyment and proper use of a Video camcorder and accessory equipment. Please read it carefully before operating your video product and keep it in a handy place for future reference.

INSTALLATION

1 Read and Follow Instructions -- All the safety and operating instructions should be read before the video product is operated. Follow-all operating and use instructions.

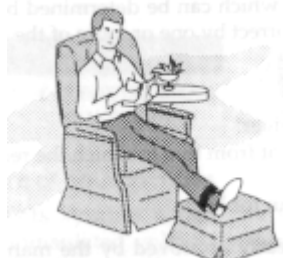

2 Retain Instructions -- The safety and operating instructions should be retained for future reference.

3 Heed Warnings -- Comply with all warnings on the video product and in the operating instructions.

4 Polarized Plug -- This video product is equipped with a polarized alternating-current line plug (a plug having one blade wider than the other). This plug will fit into the power outlet only one way. This is a safety feature. If you are unable to insert the plug fully into the outlet, try reversing the plug. If the plug should still fail to fit, contact your electrician to replace your obsolete outlet. To prevent electric shock do not use this polarized plug with an extension cord, receptacle or other outlet unless the blades can be fully inserted without blade exposure. If you need an extension, use a polarized cord.

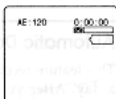

5 **Power Sources** -- This video product should be operated only from the type of power source indicated on the marking label. If you are not sure of the type of power supply to your home, consult your video dealer or local power company. For video products intended to operate from battery power, or other sources, refer to the operating instructions.

6 **Overloading** -- Do not overload wall outlets and extension cords as this can result in a risk of fire or electric shock. Overloaded AC outlets and extension cords are dangerous, and so are frayed power cords, damaged or cracked wire insulation and broken plugs. They may result in a shock or fire hazard. Periodically examine the cord and have it replaced by your service technician if appearance indicates damage or deteriorated insulation.

Characters available for your title.

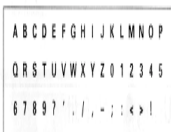

7 **Power-Cord Protection** -- Power-supply cords should be routed so that they are not likely to be walked on or pinched by items placed upon or against them, paying particular attention to cords at plugs, convenience receptacles, and the point where they exit from the appliance.

8 **Ventilation** -- Slots and openings in the cabinet are provided for ventilation to ensure

IMPORTANT SAFETY INFORMATION

reliable operation of the video product and to protect it from overheating. These openings must not be blocked or covered. The openings should never be blocked by placing the video product on a bed, sofa, rug or other similar surface. This video product should never be placed near or over a radiator or heat register. This video product should not be placed in a built-in installation such as a bookcase or rack unless proper ventilation is provided or the video product manufacturer's instructions have been followed.

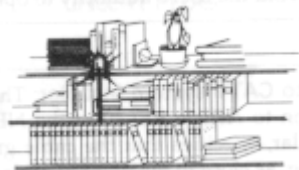

9 Attachments -- Do not use attachments unless recommended by the video product manufacturer as they may cause hazards.

Caution: Maintain electrical safety. Powerline operated equipment or accessories connected to this unit should bear the UL listing mark or CSA certification mark on the accessory itself and should not have been modified so as to defeat the safety features. This will help avoid any potential hazard from electric shock or fire. If in doubt, contact qualified service personnel.

10 Water and Moisture -- Do not use this video product near water - for example, near a bath tub, wash bowl, kitchen sink, or laundry tub, in a wet basement, or near a swimming pool, and the like.

11 Accessories -- Do not place this video product on an unstable card, stand, tripod, bracket, or table. The video product may fall, causing serious injury to a child or adult, and serious damage to the appliance. Use only with a cart, stand, tripod, bracket, or table recommended by the manufacturer, or sold with the video product. Any mounting of the product should follow the manufacturer's instructions, and should use a mounting accessory recommended by the manufacturer.

11A An appliance and cart combination should be moved with care. Quick stops, excessive force, and uneven surfaces may cause the appliance and cart combination to overturn.



12 Outdoor Antenna Grounding -- If an outside antenna or cable system is connected to the video product, be sure the antenna or cable system is grounded so as to provide some protection against voltage surges and built-up static charges. Section 810 of the National Electrical Code, ANSI/NFPA No. 70, provides information with respect to proper grounding of the mast and supporting structure, grounding of the lead-in wire to an antenna discharge unit, size of grounding conductors, location of antenna-discharge unit, connection to grounding electrodes, and requirements for the grounding electrode. See example below:

EXAMPLE OF ANTENNA GROUNDING

13 Power Lines -- An outside antenna system should not be located in the vicinity of overhead power lines or other electric light or power circuits, or where it can fall into such power lines or circuits. When installing an outside antenna system, extreme care

IMPORTANT SAFETY INFORMATION

should be taken to keep from touching or approaching such power lines or circuits as contact with them might be fatal. Installing an outdoor antenna can be hazardous and should be left to a professional antenna installer.

USE

14 Cleaning -- Unplug this video product from the wall outlet before cleaning. Do not use liquid cleaners or aerosol cleaners. Use a damp cloth for cleaning.

15 Object and Liquid Entry -- Never push objects of any kind into this video product through openings as they may touch dangerous voltage points or short-out parts that could result in a fire or electric shock. Never spill liquid of any kind on the video product.



16 Lightning -- For added protection for this video product during a lightning storm, or when it is left unattended and unused for long periods of time, unplug it from the wall outlet and disconnect the antenna or cable-system. This will prevent damage to the video product due to lightning and power-line surges.



SERVICE

17 Servicing -- Do not attempt to service this video product yourself as opening or removing covers may expose you to dangerous voltage or other hazards. Refer all servicing to qualified service personnel.

18 Conditions Requiring Service -- Unplug this video product from the wall outlet and refer servicing to qualified service personnel under the following conditions.

- a. When the power-supply cord or plug is damaged
- b. If liquid has been spilled, or objects have fallen into the video product.
- c. If the video product has been exposed to rain or water.
- d. If the video product does not operate normally by following the operating instructions. Adjust only those controls that are covered by the operating instructions. Improper adjustment of other controls may result in damage and will often require extensive work by a qualified technician to restore the video product to its normal operation.
- e. If the video product has been dropped or the cabinet has been damaged.
- f. When the video product exhibits a distinct change in performance - this indicates a need for service.

19 Replacement Parts -- When replacement parts are required, have the service technician verify that the replacements he uses have the same safety characteristics as the original parts. Use of replacements specified by the video product manufacturer can prevent fire, electric shock or other hazards.

20 Safety Check -- Upon completion of any service or repairs to this video product, ask the service technician to perform safety checks recommended by the manufacturer to determine that the video product is in safe operating condition.

IMPORTANT SAFETY INFORMATION

21 Heat -- The product should be situated away from heat sources such as radiators, heat registers, stoves, or other products (including amplifiers) that produce heat.

IMPORTANT SAFETY INSTRUCTIONS FOR AC ADAPTER/CHARGER

1. Save these Instructions -- This page contains important safety and operating instructions for AC Adapter/Charger Model VM-ACE3A.
2. Before using AC Adapter/Charger, read all instructions and cautionary markings on (1) AC Adapter/Charger, (2) battery and (3) product using battery.
3. Also read all instructions on pages 4 and 5.

4. Caution -- To reduce risk of injury, charge only rechargeable battery, VM-BPL13 or VM-BPL27.

Other types of batteries may burst causing personal injury and damage.

5. Do not expose charger to rain or snow.
6. Use of an attachment nor recommended or sold by the battery charger manufacturer may result in a risk of fire, electric shock, or injury to persons.
7. To reduce risk of damage to electric plug and cord, pull by plug rather than cord when disconnecting charger.
8. Make sure cord is located so that it will not be stepped on, tripped over, or otherwise subjected to damage or stress.
9. Do not operate charger with damaged cord or plug - replace them immediately.
10. An extension cord should not be used unless absolutely necessary.
Use of improper extension cord could result in a risk of fire and electric shock. If extension cord must be used, make sure:
 - A. The pins on plug of extension cord are the same number, size, and shape as those of plug on charger.
 - B. That extension cord is properly wired and in good electrical condition; and
 - C. That wire size should be met below:

Minimum AWG size	Length of extension cord (feet)
18	Equal to or less than 100
16	Equal to or less than 150
11. Do not operate charger if it has received a sharp blow, been dropped, or otherwise damaged in any way; take it to a qualified serviceman.
12. Do not disassemble charger: take it to a qualified serviceman when service or repair is required. Incorrect reassembly may result in a risk of electric shock or fire.
13. To reduce risk of electric shock, unplug charger from outlet before attempting any maintenance or cleaning.

Before You Begin

Any problems that occur as a result of any of the following conditions will not be covered by our warranty.

Be careful that no water, dust or sand enters the camcorder and all accessories.

When you shoot at a scene which contains an extremely bright object such as the sun

IMPORTANT SAFETY INFORMATION

or a light source, a bright vertical bar may appear in the picture.

Your camcorder is functioning properly, but the solid-state pickup device (C.C.D) usually causes this as an inherent characteristic. Try to avoid shooting an excessive bright object directly.

Be sure not to leave the camcorder in a place where the temperature exceeds 140°F (60°C), or the pickup device may be damaged.

Dangerous includes:

- Inside a car with the windows closed and in direct sunshine.
- Near heating appliances.

Do not leave the viewfinder lens and the liquid crystal display (LCD) screen facing sunlight for a prolonged period, or the phosphorescent surface of the cathode ray tube and the LCD panel may be damaged.

Read This First

To guide you, we've included:

- An "Important Safety Information" section containing important cautions for your family's safety as well as instruction for getting your video camcorder ready for use. Please read and understand this section thoroughly before moving on.
- A "Getting Started" section to familiarize yourself with the controls and prepare you for recording.
- A "Basic Techniques" section to allow you to use your video camcorder quickly and confidently before advancing to the more sophisticated features of the Hitachi VM-E535LA/VM-E635LA.
- "Advanced Techniques" to help you with some of the exciting, sophisticated features of the Hitachi VM-E535LA/VM-E635LA. We hope you will take the time to learn about these functions since they have been designed for you. You can use the video camcorder without reading this section.
- A "General Maintenance" section to help keep your purchase in good repair.

We want this manual to be as helpful as possible, so it includes two easy ways to find the information you need:

- A quick index for the information you use most often (this page).
- A detailed table of contents directing you to specific information quickly (page 8).

Get to know your video camcorder by using this manual, and get to know Hitachi. We appreciate your business.

Quick Index

Charging the Battery.....15

Setting the Date and Time.....22

Making a Basic Recording.....24

Zooming.....26

PlayBack.....28

Using the Wireless Remote Control.....42

Dubbing from camcorder to VCR.....45

Features

- Easy to use
- 3-inch color liquid display (LCD) monitor
- 32x zoom ratio
- Digital effect
- Electronic image stabilization (EIS) (Only for VM-E635LA)
- Fade in / Fade out
- Instant zoom
- Recorded date search
- Automatic title recording

Difference between models VM-E535LA/VM-E635LA

	VM-E535LA	VM-E635LA
EIS function	No	Yes

- This instruction manual shows the illustrations for the VM-E635LA.

With this camcorder you can view the picture being recorded or the playback picture whether on the LCD monitor or in the viewfinder. Opening or closing the LCD monitor switches the picture to appear on the LCD monitor or in the viewfinder. The following text describes the operation assuming that the viewfinder is used as a major monitor device.

Getting Started

This section guides you through the initial preparation of the camcorder. None of these processes are complex. Set aside some time, relax, and familiarize yourself with this quality instrument.

Enjoy getting to know all about your Hitachi 8mm camcorder. The more comfortable and familiar you are with the machine and its features, the more you can make it do for you. Let's get started!

It is crucial that you read and understand all the safety instructions before you begin. If you haven't read the safety instructions yet, please take the time to do so now.

Components and Accessories

Check that you have all the following components and accessories before proceeding.

1. Audio/video output cable
2. Battery pack
3. AC adapter/charger
4. Batteries for date/title
5. Shoulder strap
6. DC cord
7. Remote control
8. Batteries for remote control



Optional RF Adapter

If you wish to connect this camcorder to a television that does not have audio/video input jacks you will need to use the optional RF adapter model VM-RF86A (R).

The RF adapter can be purchased by calling the telephone number below. For your

Getting Started

convenience Visa, Master Card, and American Express credit cards are accepted. The RF adapter can also be purchased by mail by sending either money order or your credit card information to the following address:

HiTRON, Inc.
675, Old Peachtree RD.
Suwanee, GA 30174
Tel: 1-800-995-4500

For more information concerning the purchase of camcorder accessories, please see the optional accessory listing on page 59.

Identifying Controls

Front/Left Side Illustration

1. Lens Door

Slide the lens door opener to open and close the lens door. To protect the lens, keep the lens door closed when not recording.

2. Lens

F1.4 (4~64mm) 16:1 power zoom lens with auto focus and auto iris functions.

3. Lens Door Opener

Slide the opener to open and close the lens door. Align with OPEN to open the lens door for recording. Align with CLOSE to close it.

Hold down the small button in the opener as you slide it to CLOSE. However, you need not hold it down to slide the opener to OPEN.

4. Electronic Viewfinder

5. Diopter Control

To use the electronic viewfinder, turn this control for your optimum focus adjustment.

6. Microphone

Sensitive to sounds coming from the direction in which the camera is pointed.

7. Record Indicator

This indicator lights when the camcorder is recording.

8. Infrared Receiver

The area where infrared signals from the wireless remote are received. Aim the remote control to this area for best results.

9. Speaker

You can listen to the recorded sound.

10. OPEN Button

Push this button to open the LCD monitor.

11. BRIGHT Control

Use this to adjust the brightness of the LCD monitor screen ("Adjusting the Brightness of the LCD Screen", p19).

12. Volume Control

Use this to adjust the volume when viewing a played back picture on the LCD monitor ("Playback", p28).

13. LCD Monitor

You can view the pictures as they are being recorded and play them back immediately after recording on the 3-inch LCD screen.

14. Cassette Holder

Getting Started

A power source must be connected to the camcorder before a cassette can be inserted or removed.

15. Cassette Holder Close Button

CAUTION: Be sure to press this button to close the cassette holder. Otherwise, the tape may become slack and may be damaged.

Rear Illustration

16. INST. ZOOM (Instant Zoom) Button

Use this button to magnify the image being recorded 1.5 times.

17. EIS (Electronic Image Stabilizer) Button (only for VM-E635LA)

EIS corrects the slight shaking of an image ("Using the Electronic Image Stabilizer," p39).

18. D.EFFECT Button

Use this button to add special effects to your recording. You can select five modes - the 16x9 mode, negative/positive mode, X130 digital zoom mode, half-mirror mode and mosaic mode. (See "Digital Effects Recording" on page 36.)

19. FADE Button

The FADE button features four modes; white fade, wipe fade, zoom fade and black-and-white fade ("Using Fade," p38).

20. DATE/DISP. Button

When the CAM/OFF/VIDEO switch is set to CAM, this button can be used as the DATE button: set the date and time, and select the date display you want to record ("Setting the Date and Time", p22 and "Date Recording", p35).

In the VIDEO mode, the DATE/DISP. button is used as the DISPLAY button (Using the Display Button", p40).

Note: Be sure to insert the clock battery before setting the date and time or creating a title.

21. FOCUS Control Buttons

Press these buttons simultaneously to select manual or automatic focus. For manual focusing ("Using Manual Focus", p26), press the ▲ or ▼ buttons to bring the subject into focus. When using manual focus, "FOCUS" appears in the viewfinder or LCD monitor.

22. DC IN Jack

When using the AC adapter/charger, connect one end of the DC cord (provided) to this jack and the other end to the DC OUT jack of the AC adapter/charger. When using the car battery cord (optional), connect this jack and the DC OUTPUT jack of the car battery cord.

23. AUDIO/VIDEO Output Jacks (Behind the jack cover)

Use this jack to connect the camcorder to a VCR or television. ("Playing Back Your Recording", p30, 31, "Dubbing from the camcorder to a VCR". p45).

- Connect the yellow plug of the audio/video cable to the yellow jack (VIDEO OUT) and the white jack (AUDIO OUT).

24. Power Supply Attachment Section

Attach the battery here ("Camcorder Batteries", p16).

25. Shoulder Strap Slots

Attach the shoulder strap here.

Right side/Underside Illustration

26. BATTERY EJECT Lever

Releases the battery attached to camcorder.

27. EJECT Switch

Slide this switch to open the cassette door. A power source must be connected before cassettes can be inserted or removed though the CAM/OFF/VIDEO switch may be set to OFF ("Inserting and Removing Cassettes," p18)

28. Power Zoom Control

Use this to zoom automatically ("Using the Power Zoom," p 26).

29. PLAY Button

Use to playback recorded tapes.

30. STOP button

Use this button to stop playback, fast forward, or reverse. Also use this button to set date and time.

31. AUDIO/VIDEO Output Jack (Behind the jack cover)

Use this jack to connect the camcorder to a VCR or television ("Connecting to a Television without Audio In and Video In Jacks", p32).

32. REW/REVIEW Button

Use this button to fast forward tapes or for visual search. During visual search the camcorder rewinds at approximately 7 times normal playback speed ("Using Forward and Reverse Search", p29). Also use this button to set date and time. Furthermore, use this button to review the last few seconds of the tape you are recording.

33. F.FWD Button

Use this button to fast forward tapes or for visual search. During visual search the camcorder fast forwards at approximately 9 times normal playback speed ("Using Forward and Reverse Search", p29). Also use this button to set date and time.

34. START/STOP Button

When the CAM/OFF/VIDEO switch is in CAM press this button to start recording. When pressed a second time the camera pauses.

During playback use this button to stop the tape temporarily. Pressing a second time resumes normal playback.

35. CAM/OFF/VIDEO Power Switch

This switch turns the camcorder on and off. Set the switch to CAM for camera recording, and to VIDEO for playback. Hold down the red button as you slide the switch to CAM or VIDEO. You do not need to hold down the red button to slide the switch to OFF.

36. Hand Strap

Refer to page 20.

37. Clock Battery Compartment

Pull the battery holder and install the clock battery (provided). (See "Loading Clock and remote Control Batteries" on page 14.)

38. Tripod Mounting Threaded Socket

Use this threaded socket to mount the camcorder to a tripod.

Getting Started

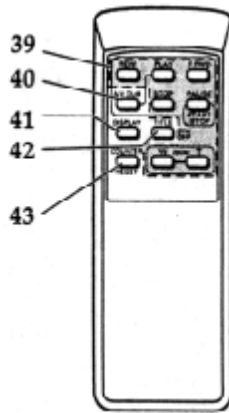

39. Recorder's Remote Control

The shaded buttons on the remote control have the same functions as the corresponding buttons on the camcorder.

40. AV DUB Button (only on the remote control)

Use this button to record new audio and video over existing audio and video.

41. DISPLAY Button

Use this button to select the viewfinder or LCD monitor and TV display ("Using the Display Button," p40). This button can be used instead of the DATE/DISP. button on the camcorder in the VIDEO mode.

42. TITLE ON/OFF Button (only on the remote control)

Use this button to create and record titles for your tapes ("Creating and Recording a Title," p 43).

43. COUNTER RESET Button (only on the remote control)

Use this button to reset the linear time counter to 0:00:00.

Loading Clock and Remote Control Batteries

Clock Battery

Install the battery to prevent misplacing it.

1. Pull out the battery holder.

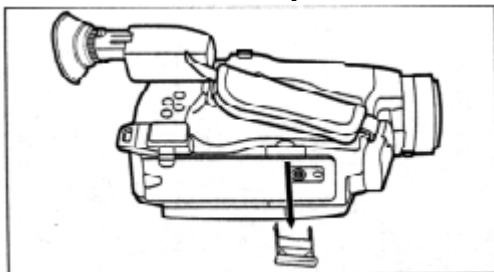

2. Insert the battery with the "+" terminal facing up.

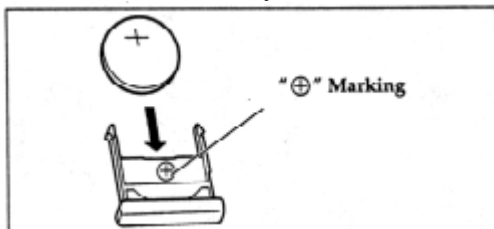

3. Fully insert the battery holder into the camcorder.

Getting Started

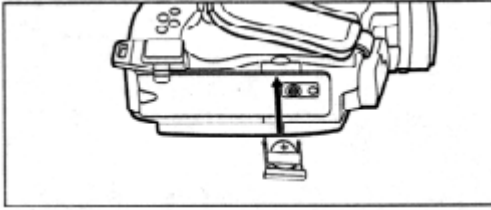

WARNING: KEEP THE BATTERY AWAY FROM CHILDREN AND PETS. IF SWALLOWED CONSULT A PHYSICIAN IMMEDIATELY FOR EMERGENCY TREATMENT.

Note: Replace the battery with 3V micro lithium cells such as Maxell CR2025 or its equivalent.

Note: Dispose of battery safely in accordance with local laws. Do not dispose of in fire.

Note: Do not short circuit the battery.

Note: Do not take apart the battery.

Note: Do not hold the battery with the metallic tweezers.

Note: Do not recharge the battery.

Note: Keep the battery in a dark, cool, dry place.

Remote Control Batteries

The remote control requires two "AA" batteries.

1. Slide the cover in the direction of the arrow to remove it.

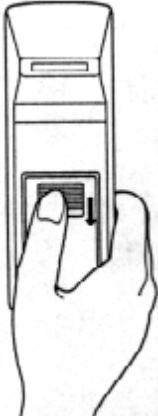

2. Install batteries. Be careful to install with correct polarity.

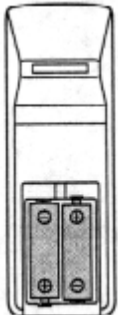

3. Re-attach the cover to the remote control.

Cautions on the batteries:

- Do not use the old and new batteries at the same time.
- Do not mix batteries of different types.
- Do not short, take apart or dispose of batteries by throwing them into a fire.

- When liquid leaks, wipe it off completely and then insert new batteries.

Charging the Battery

The first step is to set the battery to charge. To charge the battery, use the provided AC adapter/charger.

Note: This camcorder operates with the Lithium ion battery such as VM-BPL13/VM-BPL27.

Charge the battery on a flat surface without vibration.

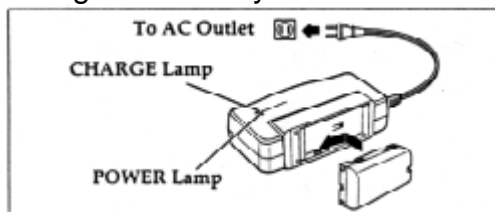

1. Plug the AC adapter/charger power cord into an AC outlet. The POWER lamp (red) lights up.
2. Align the bottom of the battery with mark ► on the AC adapter/charger, and then slide it in the direction of the arrow as shown in the figure. The CHARGE lamp (green) will light.
3. The CHARGE lamp will repeatedly light for 3 seconds and then go off to show that the battery has been charged to approximately 70% of capacity. When the CHARGE lamp goes out, the battery has been completely charged. After the lamp goes out, unplug the AC adapter/charger from the AC outlet and remove the battery from the AC adapter/charger.

Note: You can use the battery before it is completely charged.

Note: Remove the DC cord from the AC adapter/charger before attempting to charge the battery.

Note: If you re-attach the fully charged battery to the AC adapter/charger after the CHARGE lamp goes out, the lamp will light. This simply informs you that the battery has been completely charged; it does not indicate that the charge has been insufficient.

Charging Time

Charging	Battery pack	VM-BPL13	VM-BPL27
Full charge		130 min.	230 min.
70% charge		70 min.	140 min.

Note: Charge the battery at temperatures 32-104°F (0-40°C). At temperatures outside this range, charging will take longer.

Note: The battery cannot be charged at extremely high or low temperatures. The CHARGE lamp will flash at 2-second intervals to show that charging is no longer taking place.

Operating Time

The camcorder operating time depends on how often you turn power on/off and use start/stop and zoom.

	Battery pack		
Recording	LCD monitor	VM-BPL13	VM-BPL27
Continuous	OFF	120 min.	270 min.
recording	ON	100 min.	220 min.
Typical	OFF	70 min.	160 min.
recording	ON	60 min.	130 min.

Notes on the Battery

- It is recommended that the battery always be left in the discharged state when not in use, and charged before you use it.
- Avoid storing a fully charged battery, and do not store it in a place where the temperature is high: this will damage the battery.
- Do not operate the battery at temperature below 14°F (-10°C) or above 113°F (45°C). At extremely low temperatures operation time decreases, while at high temperature the battery may be damaged.
- If the POWER lamp begins to flash during charging, remove the battery and then reattach it to the AC adapter/charger. If the POWER lamp continues to flash after several attempts to attach it, the battery is unable to take a charge and must be replaced.
- Do not attach a hot battery to the AC adapter/charger. Allow it to cool. Attaching a hot battery to the AC adapter/charger causes the POWER lamp to flash.

THERE ARE NO USER-SERVICEABLE PARTS INSIDE THE BATTERY OR AC ADAPTER/CHARGER.

THROWING THE BATTERY INTO FIRE OR EXPOSING IT TO EXCESSIVE HEAT (ABOVE 140°F [60°C]) MAY CAUSE INJURY.

SHORTING THE BATTERY'S TERMINAL INCREASES RISK OF FIRE OR ELECTRICAL SHOCK.

Camcorder Batteries

Using Battery Pack

Before you install the battery for the first time it must be fully charged. See "Charging the Battery" on page 15 for details.

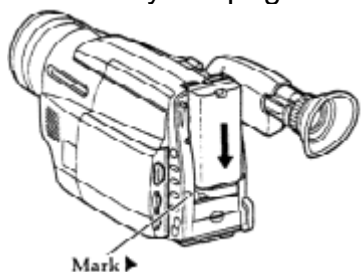

1. Align the bottom of the battery with mark ▶ on the camcorder so that the battery fits into the grooves.
2. Slide the battery downward, as illustrated.

Note: Always remove the battery from the camcorder after use.

Note: We cannot guarantee against malfunctions of the camcorder which occur when you use battery packs other than those specified.

Note: Always attach a battery by the procedure described here. Attaching a battery forcibly

could damage it.

Removing the Battery Pack

Slide the BATTERY EJECT lever in the direction of the arrow and hold it, then slide the battery to the upper side and remove it.

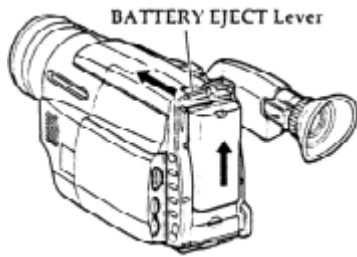

Checking the Battery's Charge

A battery charge indicator is located on the upper right corner of the viewfinder or LCD monitor. One of six symbols displays when the battery is used.

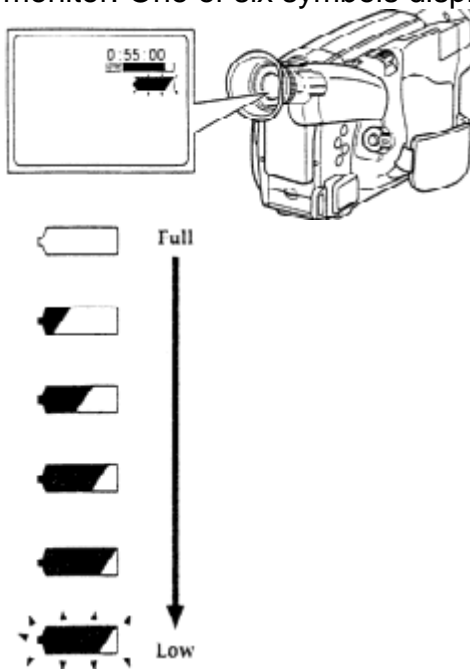

This flashing symbol indicates a battery nearly out of power. Use an alternative power source or charger the battery before continuing to use the camcorder.

Note: The battery charge indicator does not appear when the camcorder is powered by the AC adapter/charger.

Using Alternative Power Sources

Using the AC Adapter/Charger

Please ensure that the CAM/OFF/VIDEO switch is in the OFF position whenever attaching or detaching any power supply (ie. battery, AC adapter/charger, etc.)

Getting Started

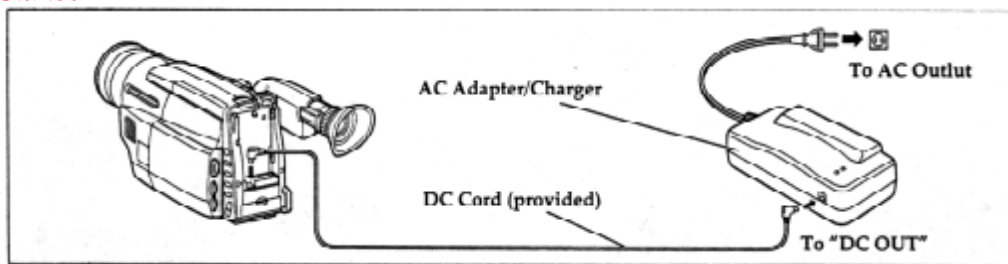

1. Plug the AC adapter/charger power cord into an AC outlet. Make sure that the wide blade fits into the wide slot. If it doesn't fit try reversing it. If you still cannot make fit the blades fully into the outlet either contact an electrician to replace your obsolete outlet, or use a polarized cord or outlet accessory.
2. Connect one end of the DC cord (provided) to the DC IN jack of the camcorder. Connect the other end of the DC cord to the DC OUTPUT of the AC adapter/charger.

Note: The AC adapter/charger can be used around the world. An AC plug adapter is required in some foreign countries. If you need one purchase it at your Hitachi distributor.

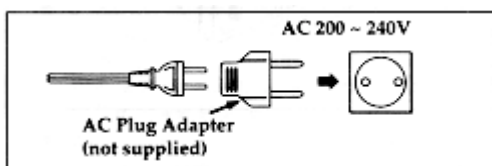

Using a Car Battery

The camcorder can be powered with a car battery by using an optional car battery cord (Hitachi VM-CC80A) to plug the camcorder into the car's cigarette lighter socket. Please ensure that the CAM/OFF/VIDEO switch is in the OFF position whenever attaching or detaching any power supply (ie. battery, AC adapter/charger, etc).

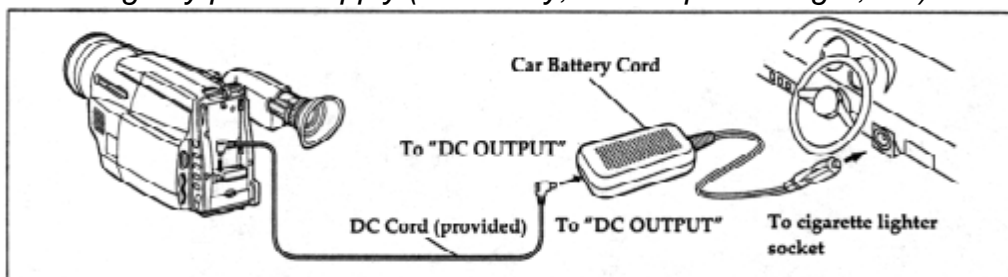

1. Plug the car battery cord into the car's cigarette lighter socket.
2. Connect one end of the DC cord (provided) to the DC IN jack of the camcorder. Connect to other end of the DC cord to the DC OUTPUT of the car battery cord.

Note: Only use the car battery cord with cars having 12/24 volt negative ground system.

Inserting and Removing Cassettes

A power source must be connected before inserting or removing cassettes. Once connected cassettes can be inserted or removed whether the CAM/OFF/VIDEO switch is on or off.

Inserting a Cassette

Getting Started

1. Press the OPEN button to open the LCD monitor ("Opening the LCD Monitor", p19).
2. Slide the EJECT switch. "EJECT" will appear on the LCD monitor, and the cassette door will open automatically.

Caution: Be careful not to catch your fingers between the cassette door and the camcorder as it could cut you.

Note: Cassette cannot be inserted or ejected unless the LCD monitor is open.

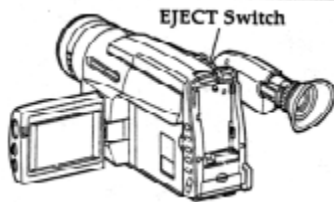

3. Place the cassette in the cassette holder so that the transparent window faces away from the body of the camcorder and the sprockets toward the body of the camcorder.

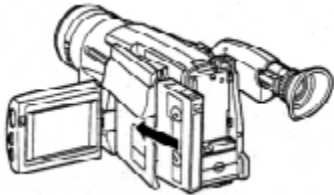

4. Push the cassette holder, which is embossed PUSH LOCK on the left hand side, until it "clicks" into place. The camcorder automatically closes.

Caution: Be sure that you push the cassette holder embossed PUSH LOCK to close the holder. Otherwise, the holder will not click into place and the tape may be slack which could lead to damage.

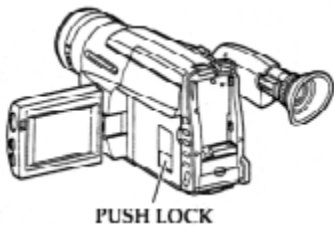

Note: If "TAPE" flashes in the viewfinder or LCD monitor, remove the cassette and check that the tape is not damaged, is not slack or no dust adheres to it, etc. After making sure that there is no abnormality, reinsert the cassette. If "TAPE" reappears, see "Troubleshooting" on page 53.

Removing a Cassette

Press the EJECT switch. "EJECT" will appear on the LCD monitor, and the cassette door opens automatically. Remove the cassette.

Protecting Recorded Material

Protect 8mm cassettes from accidental erasure by sliding the tab on the side of the cassette towards the opposite side until the tab is completely visible. Slide the tab in the opposite direction, until the tab disappears, to record on the cassette again.

Getting Started

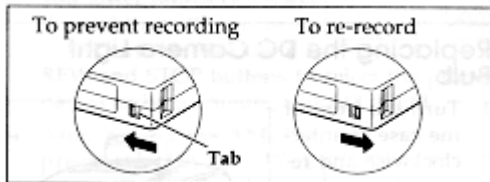

LCD Monitor

When using the LCD monitor during recording and playback, you can adjust the brightness of its screen and the angle of the monitor.

Opening the LCD Monitor

1. Press the OPEN button to open the LCD monitor.

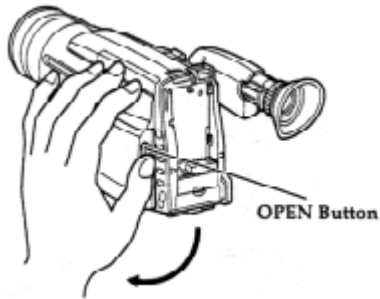

Adjusting the Brightness of the LCD Screen

Note: Even when the picture on the LCD monitor is adjusted, the recorded video will not change.

1. Load the battery ("Loading Batteries: Camcorder Batteries", p16). Press the red button on the CAM/OFF/VIDEO switch as you slide it to CAM or VIDEO.

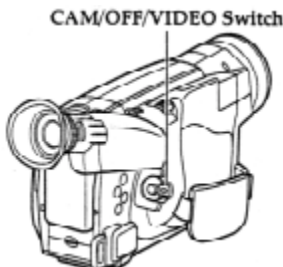

2. Use the BRIGHT control on the side of the LCD monitor to adjust the brightness of the LCD screen.

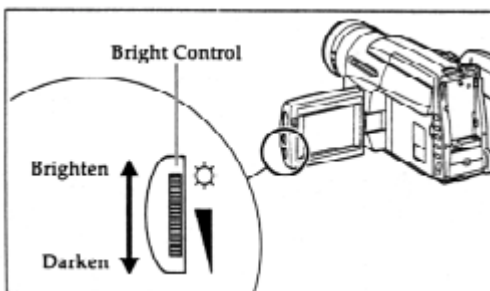

Range in which the LCD Monitor can be moved

Getting Started

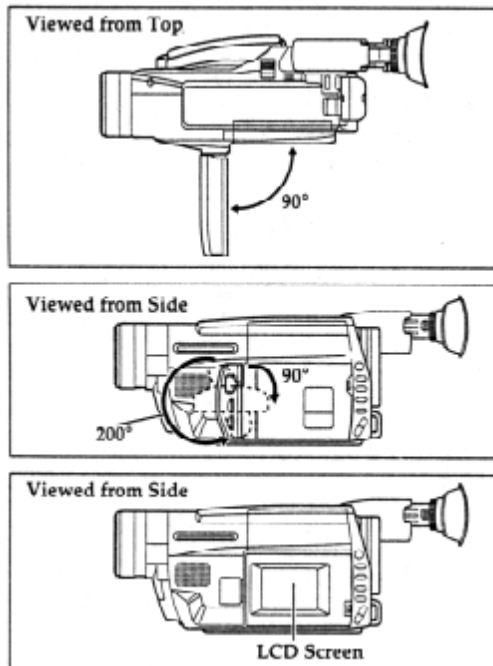

Cautions on LCD Monitor Screen

- Do not touch the LCD screen with your fingers as the screen could get dirty and the picture will not be seen clearly. If the LCD screen becomes dirty, use a soft cloth to wipe off the dirt.
- If the camcorder is used in a cold place and becomes too cold, the LCD screen will be dim for a while after the power is turned on. When the temperature inside the camcorder rises, the brightness of the picture will become normal.
- Do not hold by the LCD monitor as this could cause a malfunction.
- Open the LCD monitor by 90° before changing its direction. If you were to attempt to invert its direction before opening it completely, it could cause a malfunction.
- The LCD monitor cannot be closed if it is tilted.
- Close the LCD monitor after making sure it is parallel with the camcorder. If you were to close the monitor while it faces the same direction as the lens or it is diagonal, it could damage the LCD monitor.
- Do not disassemble the LCD monitor as this might cause a malfunction.
- When opening the LCD monitor, be careful that no water droplets adhere to the monitor screen and that no water or dust enters the camcorder through the gap as it could cause a malfunction.

Adjusting the Electronic Viewfinder

The electronic viewfinder adjusts simply by pivoting it to a position where it is comfortable and easy to see through. Place the viewfinder back in its original position before storing the camcorder in its case or carrying the camera recorder around to avoid damaging the viewfinder or camcorder.

Getting Started

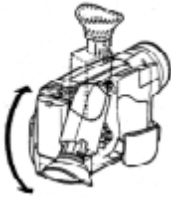

CAUTION: Do not hold the unit by the electronic viewfinder when carrying as this could cause a malfunction.

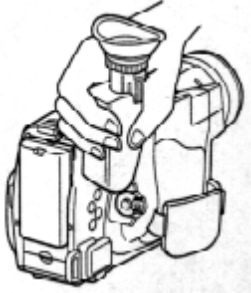

Eyepiece Adjustment

To use the electronic viewfinder, pull out the eye cup all the way and turn the diopter control for your optimum focus adjustment.

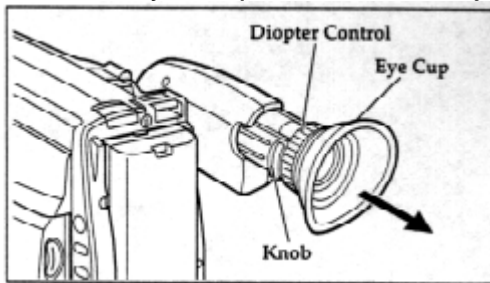

Note: Be sure to pull out the eye cup all the way so that you can see the subject in the viewfinder clearly.

Note: Hold the knobs on both sides of the eye cup stem to pull out the eye cup.

Note: The eye cup stem can be retracted when the camcorder is being carried.

Adjustment the Hand Strap

Adjust the hand strap to best fit your hand.

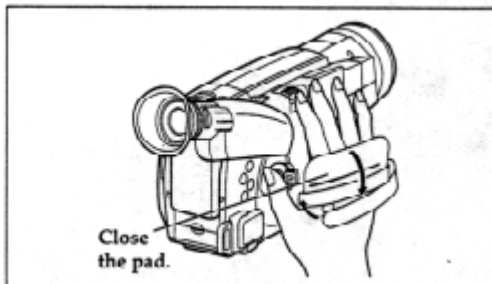

Note: After adjustment, close the hand strap's pad securely.

Lens Door Opener

Slide the opener to open and close the lens door. Align the " " mark with OPEN to open the lens door for recording. Align with CLOSE to close it. Hold down the small button in the opener as you slide it to CLOSE. However, you need not hold it down to slide the opener to OPEN.

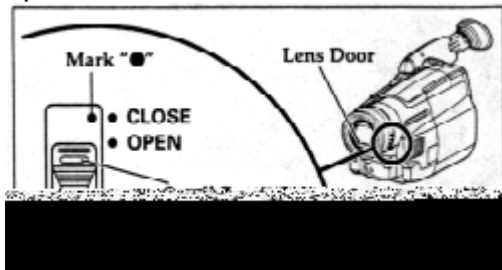

Attaching the Shoulder Strap

Thread the ends of the provided shoulder strap through the slots at the back of the camcorder and thread through the shoulder straps' buckles.

Note: Make sure that the straps are securely fastened before using the shoulder strap to carry the camcorder.

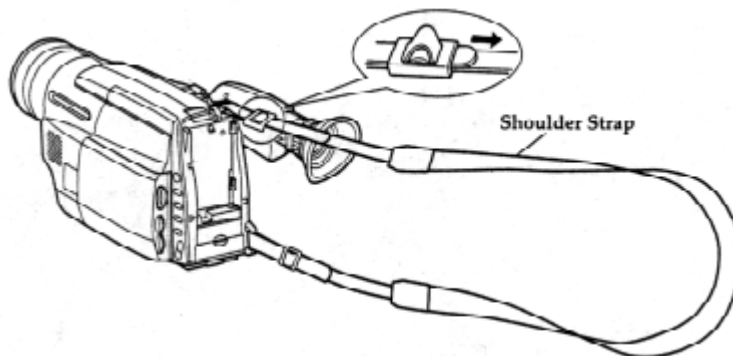

Using the Linear Time Counter

The linear time counter displays the tape run in hours, minutes, and seconds, helping you to keep track of how long you've been filming or time you have left to film before running out of tape.

Turn the camcorder on to display the linear time counter. The linear time counter keeps track from when you load a cassette into the camcorder and clears to 0:00:00 when the cassette is ejected.

Getting Started

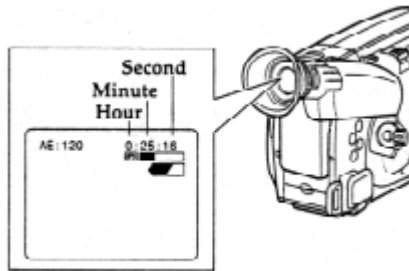

Remaining Tape

The tape remaining display shows the remaining tape that can be used for recording and playback, using seven dashes. This feature is handy when recording since it lets you know how long you can record on the loaded tape.

Insert a cassette into the camcorder and start recording or playback; 10 seconds later, the remaining tape will be displayed. When the cassette is ejected, the display will disappear. "00:-----" is displayed for 10 seconds after the tape starts to run.



Note: The tape remaining display appears 10 seconds after the tape starts to run.

Note: When the remaining tape time becomes less than about three minutes, "TAPE END" flashes in the viewfinder or LCD monitor.

Setting the Date and Time

Take the time to set the date and time now. The date and time can be recorded on your tapes to act as a handy reference when viewing them later. Use the following procedure to set up the display for the current date and time.

Note: Be sure to insert the clock battery before setting the date and time. Although the date and time can be set without the clock battery inserted, they will disappear when the battery providing power to the camcorder is removed.

Make sure that the current time is displayed correctly before you start filming.

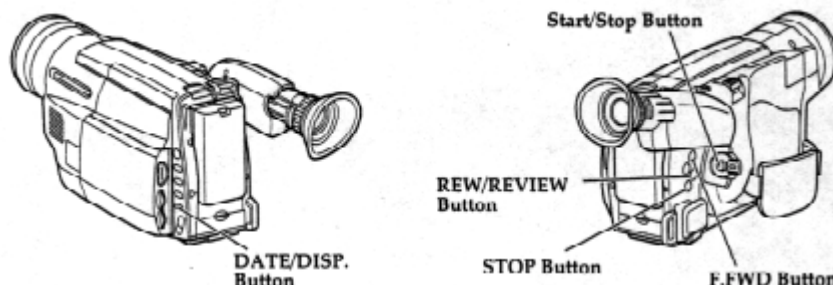

1. Load the battery ("Loading the Batteries: Camcorder batteries" p16). Press the red

Getting Started

button on the CAM/OFF/VIDEO switch as you slide it to CAM.

2. Press the DATE/DISP. button and look into the viewfinder or LCD monitor. The date and time should appear in the lower right with the "1" flashing.



3. Pressing the F.FWD button gives you higher numbers while the REW/REVIEW button gives you lower numbers. Select the right month and press STOP button. Use the F.FWD, REW/REVIEW and STOP buttons to select the proper day, year, hour, minute, and AM or PM.

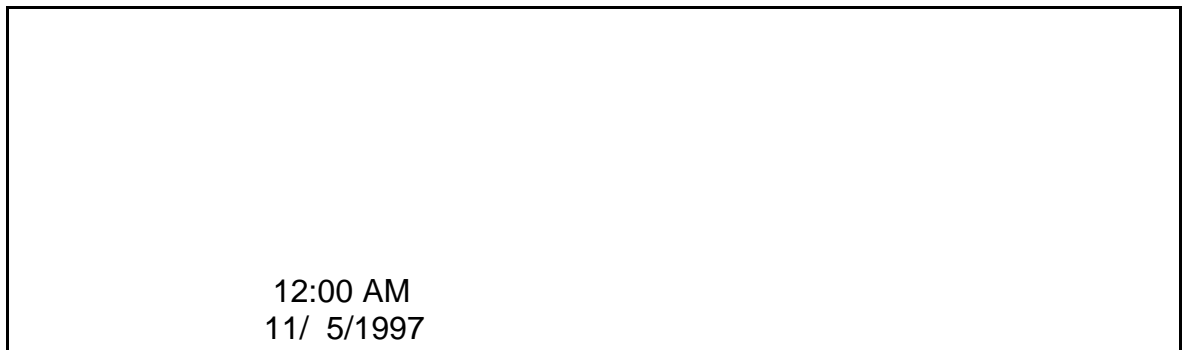

4. After setting the AM/PM, press the DATE/DISP. button. The display changes and the internal clock starts.

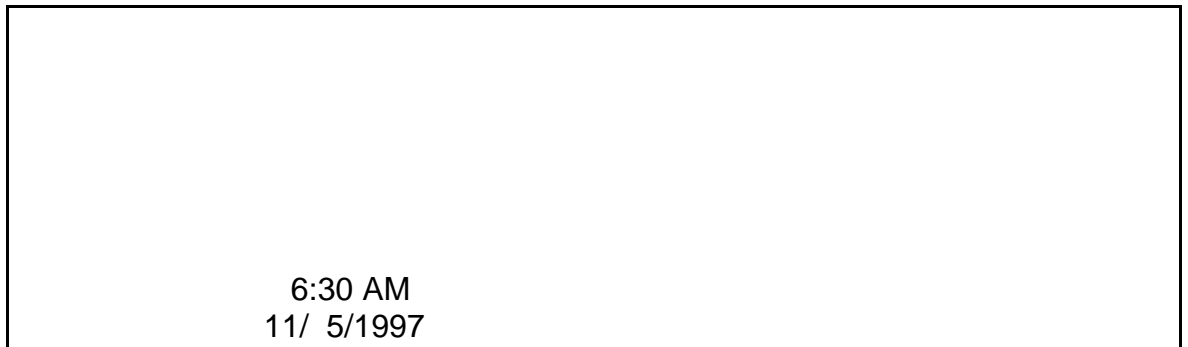

Note: After the date and time are set, " AUTO" appears and the camcorder enters the automatic date recording mode. See "Date Recording" on page 35.

Correcting the Date and Time

1. Press the DATE/DISP. button while pressing the STOP button. The flashing cursor appears at the month.

2. Move to where you need to make the correction with the STOP button and use the F.FWD and REW/REVIEW to correct.

3. Press the DATE/DISP. button to set the corrected date and time.

Basic Techniques

The batteries are in place and charged, the date and time are set, and you are familiar with the controls its time to make a recording. Basic recording is easy and simple. Hooking up the camcorder to your TV is not complicated but give yourself plenty of time to ensure connections are correct.

This section guides you through basic recording and playback. Practice the basic techniques of recording and playback on something unimportant such as traffic or a short tour of your backyard. Once familiar with how the machine works you can move to the more sophisticated features with less stress.

Let's get started!

Making a Basic Recording

The Hitachi VM-E535LA/VM-E635LA uses PROGRAM AE auto exposure that automatically selects the optimum shutter speed (either 1/60, 1/120, 1/180, 1/250, 1/350, 1/500, 1/750, 1/1000, 1/1500, 1/2000, or 1/4000 of a second). The iris adjusts automatically in response to shutter speed.

1. Connect the camcorder to a power source ("Loading Batteries; Camcorder Batteries," p 16 ~ p17).
2. Open the LCD monitor and insert a cassette ("Inserting and Removing Cassettes," p18).

If you want to view the picture being recorded on the LCD monitor, leave the monitor open. If you want to view the picture in the viewfinder, close the LCD monitor.

Note: Pull out the eye cup all the way when using the viewfinder.

3. To open the lens door, slide the lens door opener to OPEN ("Lens Door Opener", p20)
4. Press the red button on the CAM/OFF/VIDEO switch as you slide it to CAM. " ■ " appears and the camcorder is now ready to record.
5. When you are ready to record press the Start/Stop button. "REC" appears in the viewfinder or LCD monitor and the camcorder records the picture you see in the viewfinder or LCD monitor.
6. To stop recording press the Start/Stop button and "REC" disappears from the viewfinder or LCD monitor replaced by " ■ ". This places the camcorder in standby.
7. After recording, close the lens door. Press and hold the small button in the lens door opener, and then slide it to CLOSE.

Basic Techniques

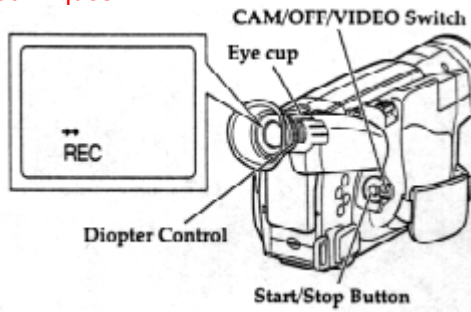

Note: If the LCD monitor is opened or closed (the monitor picture is switched between the viewfinder and LCD monitor) during recording, the on-screen display will disappear for about one second. It is recommended that you do not switch the picture during recording as the date or title superimposed in the picture being recorded will disappear for about one second.

Note: If the LCD monitor is opened or closed during recording, several white stripes may appear in the picture, but this does not indicate a fault. However, these stripes are recorded with the picture, so it is recommended that you do not close or open the LCD monitor during recording.

Note: "TAPE" flashes in the viewfinder or LCD monitor when the tab on the side of the cassette is completely visible.

Note: "TAPE END" flashes in the viewfinder or LCD monitor when about 3 minutes or less remain of the tape cassette.

Note: If the camcorder is left in record/pause mode for more than 5 minutes, the camcorder turns off automatically. To restart it press the Start/Stop button and the camera returns to record/pause mode.

Using Instant Review

Use this feature to view the last few seconds of the tape you shot.

1. Set the camcorder to record/pause mode and tap the REW/REVIEW button. The last few seconds of tape play back in reverse and then in normal playback mode.

Note: Sound is heard from the speaker during normal playback.

2. The camera plays back to the spot where you paused and returns to record/pause mode (standby). Press the Start/Stop button to resume recording.

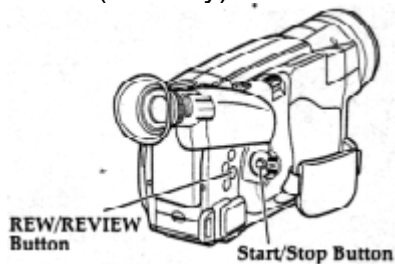

Using Auto Focus

Basic Techniques

The camcorder focuses the subject in the center of the viewfinder or LCD monitor automatically unless the manual focus is engaged. If "FOCUS" appears in the viewfinder or LCD monitor, manual focus is engaged. Press the FOCUS control buttons simultaneously to return to auto focus.



Good



No good

The auto focus will not work under the following conditions and you must focus manually:



Objects outside the center of the viewfinder or LCD monitor



Objects at different distances in the center of the viewfinder or LCD monitor



Brightly lit objects such as a neon light, objects lit by spotlight, etc.



Objects behind water dappled or dusty glass

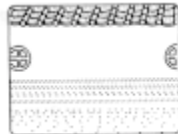

Objects with little difference in light reflection such as a white wall



Rapidly moving objects



Dark objects

Note: With the T zoom control you can use the auto focus with subjects that are 3.3 feet (100 cm) away from the lens and further away to infinity. With the W zoom control you can use the auto focus with subjects 3/8 inches (1 cm) away from the lens and further away to infinity.

Using Manual Focus

1. Press the FOCUS control buttons simultaneously. "FOCUS" displays in the viewfinder or LCD monitor. You can adjust the focus manually.
2. Use the power zoom T control to zoom up completely to your subject. If you don't use the T control to zoom to the picture you want, the picture may fall out of focus when actual recording starts.
3. Press the Focus control ▲ (far) or ▼ (near) button until the subject is in focus.
4. Use the power zoom W control to zoom back to the picture you desire.

Note: To return to auto focus press the FOCUS control buttons and the "FOCUS" disappears from the viewfinder or LCD monitor.

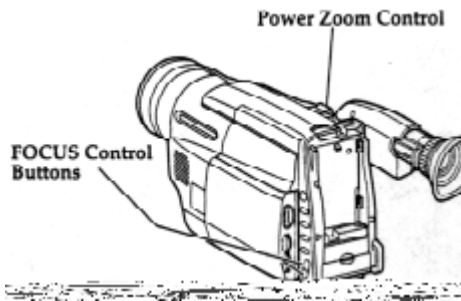

Using the Power Zoom

The power zoom W control widens the picture, moving the subject farther away, while the power zoom T control brings the subject closer, narrowing the picture. If "ZOOM" appears at the left of the viewfinder or LCD monitor, the digital zoom function shown below has been engaged.

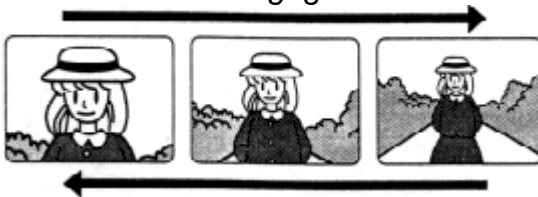

When the power zoom switch is operated, the zoom position is displayed in the viewfinder or LCD monitor for about 5 seconds and then disappears. The zoom position is displayed in 10 steps.

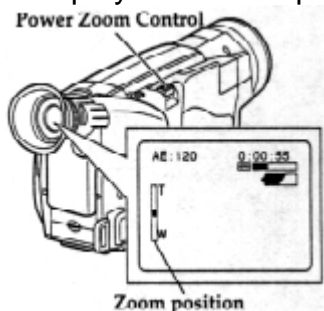

Using the Digital Zoom

Basic Techniques

The digital zoom increases the magnification of the power zoom by 2 times. You must place the subject you wish to magnify at the center of the viewfinder or LCD monitor.

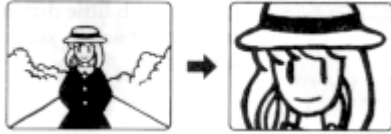

Slide and hold the power zoom control to the "T" side until you find the picture you want. You control the zoom with the power zoom T and W controls. When "ZOOM" is not displayed in the viewfinder or LCD monitor, normal zoom functions resume.

Note: This digital zoom has certain limitation and may degrade at extreme magnification and amplify camcorder's movement.

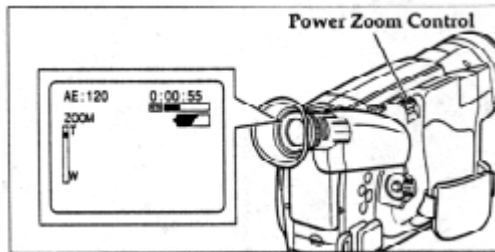

Using the INST. ZOOM (Instant Zoom) Button

The instant zoom feature activates the digital zoom to magnify the subject 1.5 times regardless of zooming engaged by the power zoom T and W controls.

Press the INST. ZOOM button. I. ZOOM appears at the left of the viewfinder or LCD monitor and the picture is magnified 1.5 times.

Note: To return to the original zoom position, press the INST. ZOOM button so that "I. ZOOM" disappears from the viewfinder or LCD monitor.

Note: This instant zoom has certain limitations and may degrade at extreme magnification and amplify camcorder's movement.



Using Macro

This function allows you to shoot subjects as close as 3/8 inches (1cm). Press and hold the power zoom control W. The camera focuses on the subject automatically. Check your lighting as it tends to be insufficient when filming close up.

Basic Techniques

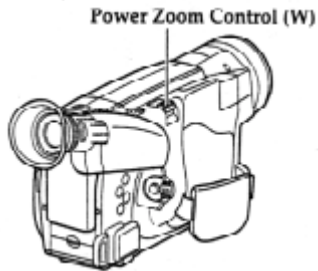

Active Screen

The camcorder automatically brightens the backlight of the LCD monitor when you are recording a bright subject outdoors, so that the LCD screen is easy to see.

Note: When you record a bright subject outdoors, the camcorder operating time will be less than when recording indoors.

Note: Even if you record outdoors, the LCD monitor backlight may not brighten, if you are aiming at a dark subject.

Playback

You can view recorded pictures on the 3-inch LCD monitor immediately after recording.

1. Open the LCD monitor, and then adjust the angle of the monitor ("Opening the LCD Monitor", p19).

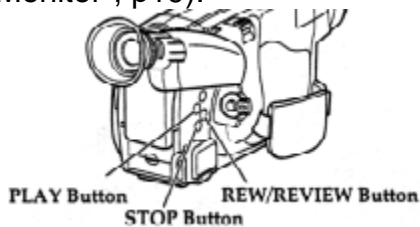

2. Hold down the red button on the CAM/OFF/VIDEO switch while sliding the switch to VIDEO.

3. Press the REW/REVIEW button to the position where you want to start playback.

4. Press the PLAY button and play back the tape. To adjust the volume for the internal speaker, adjust the Volume control at the bottom of the camcorder.

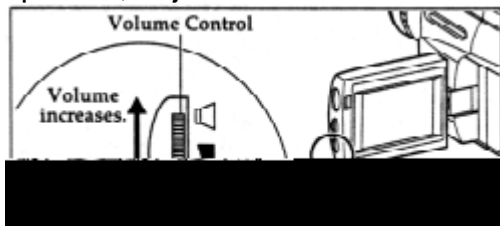

5. Press the STOP button when you have finished.

Note: Decrease the sound volume of the camcorder when you play back a recording by connecting the camcorder to your TV. If the volume of the camcorder is set to your TV. If the volume of the camcorder is set to maximum, the played back picture may be distorted. Make sure that the volume is not set to maximum during recording as it could distort the

Basic Techniques

played back picture.

Note: When the LCD monitor is turned on and left as it is, the monitor becomes warm, but this does not indicate fault.

Note: When the CAM/OFF/VIDEO switch is set to CAM or VIDEO, the LCD monitor is turned on and off automatically when the LCD monitor is opened and closed.

Note: It is recommended that you close the LCD monitor to save the battery power when playing back a picture on a TV or recording or TV program without viewing it.

Note: Only the playback sound is heard. The sound being recorded is not heard.

Simple Playback (Using the Electronic Viewfinder or LCD monitor)

1. Insert the cassette ("Inserting and Removing Cassettes," p18).
2. Hold down the red button on the CAM/OFF/VIDEO switch while sliding the switch to VIDEO.
3. Press the PLAY button and enjoy your video.
4. Press the STOP button when finished.

Using Still

To view a still picture during playback press the Start/Stop. Press the Start/Stop button again to resume playback. If you leave the camcorder in play/pause mode for more than 5 minutes the camcorder automatically stops the cassette to prevent damage to the tape.

You can view a still picture with less noise on the LCD monitor.

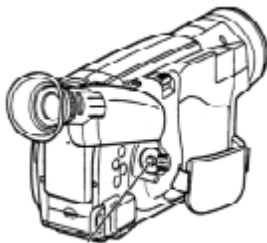

Start/Stop Button

Note: The still picture will have several noise bars in the viewfinder and on the TV, but this does not indicate a fault.

Note: If you are freezing a picture with the LCD monitor closed, then you will not be able to view a still picture with less noise when you open the monitor.



Using Forward and Reverse Search

When the LCD monitor is closed:

When looking for a particular point in your videotape use the F.FWD button and REW/REVIEW button to find the spot quickly.

- Press F.FWD button during playback to play the tape forward at approximately 9 times normal speed. Press PLAY button to return to normal playback.
- Press REW/REVIEW button during playback to play the tape backwards at approximately 7 times normal speed. Press PLAY button to return to normal playback.

Basic Techniques

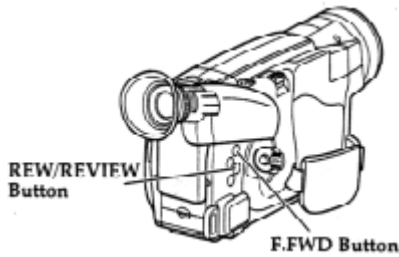

Note: When you engage F.FWD button or REW/REVIEW button the picture will have some interference or noise. This is normal during search mode.



When the LCD monitor is open: (Clear Search)

You can view pictures with less noise on the LCD monitor during forward or reverse search.

- Press F.FWD button during playback to play the tape forward at 6 times normal speed. Press PLAY button to return to normal playback.
- Press REW/REVIEW button during playback to play the tape backwards at 4 times normal speed. Press PLAY button to return to normal playback.

Note: If you are using forward or reverse search with the LCD monitor closed, then you will not be able to view pictures with less noise when you open the monitor.

Note: Several noise bars will appear on the TV screen during forward or reverse search.

Playing Back Your Recording on Your TV

Depending on the setup of your video equipment, you connect the camcorder in one of the 3 methods explained below.

Connecting to a Television with a VCR Attached

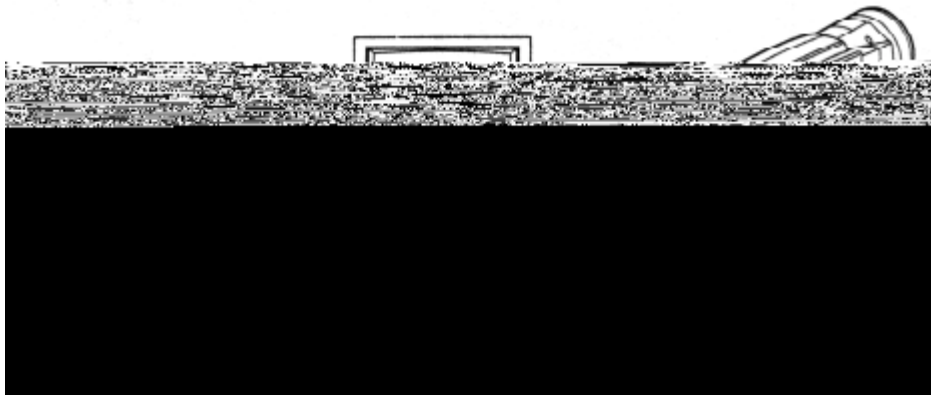

1. Connect the provided audio/video output cable to the AUDIO IN and VIDEO IN jacks of your VCR.

Note: If your VCR has two (stereo) AUDIO IN jacks, connect the audio plug to the left-

channel AUDIO IN jack.

2. Connect the other ends of the cable to the AUDIO OUT and VIDEO OUT jacks of the camcorder.
3. Insert a previously recorded cassette into the camcorder.
4. Turn on your VCR and place it in the camcorder input mode (consult your VCR manual for details). Operate the television as you normally do to see the signal coming from the VCR.
5. Hold down the red button on the CAM/OFF/VIDEO switch while sliding the switch to VIDEO.

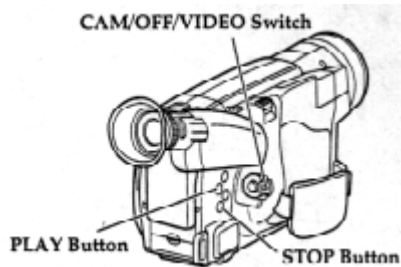

6. Press the PLAY button to begin playback.
7. Press the STOP button when finished.

Connecting to a Television with Audio In and Video In Jacks

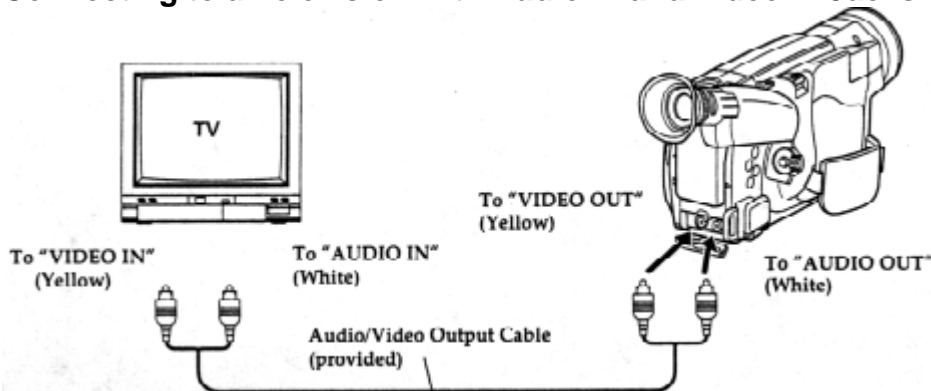

1. Connect the provided audio/video output cable to the AUDIO IN and VIDEO IN jacks of your television.

Note: If your television has two (stereo) AUDIO IN jacks, connect the audio plug to the left-channel AUDIO IN jack.

2. Connect the other ends of the cable to the AUDIO OUT and VIDEO OUT jacks of the camcorder.
3. Insert a previously recorded cassette into the camcorder.
4. Turn on your television and set to the camcorder input mode (consult your television manual for details).
5. Hold down the red button on the CAM/OFF/VIDEO switch while sliding the switch to VIDEO.

Basic Techniques

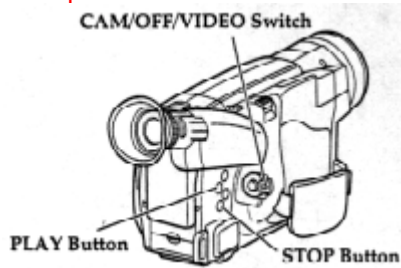

6. Press the PLAY button to begin playback.
7. Press the STOP button when finished.

Connecting to a Television without Audio In and Video In Jacks

Connection Diagram

1. Disconnect the VHF antenna leads from the back of the television. Leave the UHF antenna leads connected.
2. Connect the VHF antenna lead to ANT IN of the RF output adapter. If the cable on the VHF antenna lead is flat you need to purchase an antenna adapter (300-ohm to 75-ohm transformer). Connect the antenna adapter to the VHF antenna lead and slide the adapter on to the ANT IN terminal.
3. Connect the 75-ohm coaxial cable of the RF output adapter to the VHF antenna terminals on the back of the television. If the television is set up to connect to a flat antenna lead you need to purchase antenna adapter (75-ohm to 300-ohm transformer). Connect the adapter to the 75-ohm coaxial cable of the RF output adapter and connect the free ends of the adapter to the VHF antenna terminals at the back of your television.
4. Connect the RF output adapter cable to the Audio/Video Output jack of your camcorder.

Advanced Techniques

The Hitachi VM-E535LA/VM-E635LA offers a diverse group of features that add interest and excitement to your video. Adding fades to smooth transitions creates video with a professional look.

As you learn and practice with these features think of situations that they might fit in and add a special touch.

Changing the Angle of the LCD Monitor when Recording

You can change the angle of the LCD monitor so that the picture on the LCD screen can be monitored from different positions.

See "LCD Monitor" (p. 19) for the range in which you can change the angle of the LCD monitor.

Note: You need the remote control to operate the camcorder.

Recording an Image of Yourself while Monitoring the LCD Screen

1. Open the LCD monitor ("Opening the LCD Monitor", p19).
2. Turn the LCD monitor so the monitor screen faces the same direction as the lens.

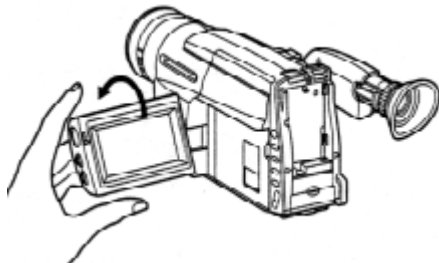

Press the START/STOP button on the remote control, and the camcorder will begin recording.

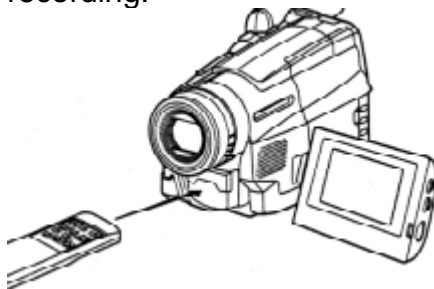

Note: When you record an image of yourself, the image displayed on the LCD will be the reverse of a mirror image.

Note: Tilt the LCD monitor in the direction of the camera lens so that it faces up slightly, and the screen may be viewed easily.

Date Recording

When the date has been set, the camcorder will enter the automatic date recording mode automatically.

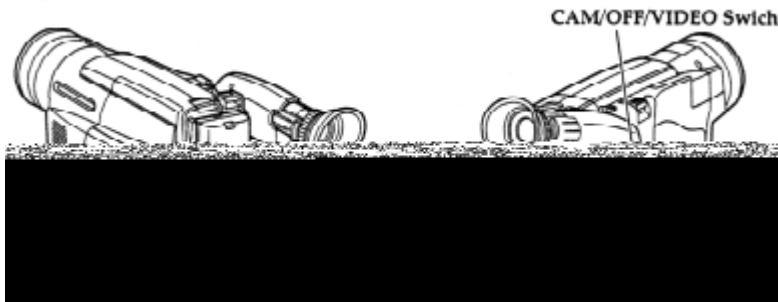

1. Press the red button on the CAM/OFF/VIDEO switch as you slide it to CAM.
2. Press the DATE/DISP. button to specify the date display you want to record.

" AUTO" and Date - Automatic Date Recording

This option records the date automatically once a day at the beginning of recording for 10 seconds

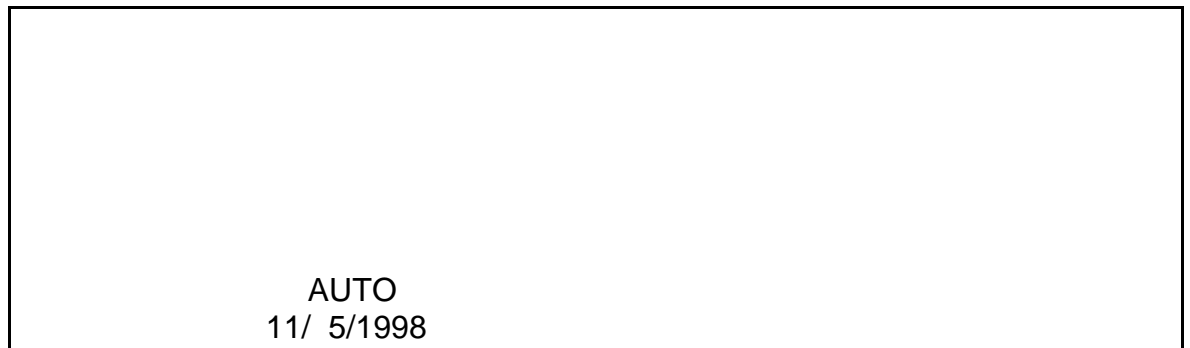

Note: The camcorder records the same date when;

- the cassette is replaced.
- you select " AUTO" and date display again.
- the recording is less than 10 seconds long.

Note: If the date changes while recording continues over 10 seconds, the new date is recorded for about 10 seconds the next time you make a recording.

" TITLE" and Date - Automatic Title and Date Recording

This option records the date and created title (see "Creating and Recording a Title", p43) automatically once a day at the beginning of recording for 10 seconds.

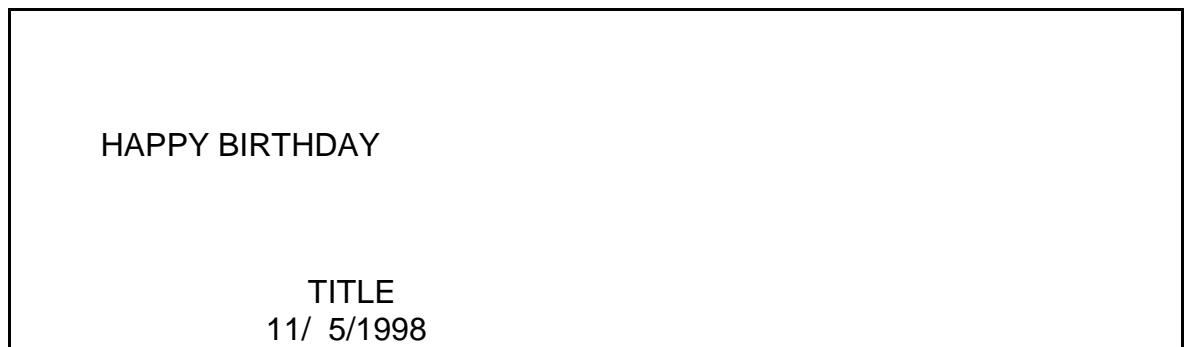

Note: When " TITLE" is displayed in the viewfinder or LCD monitor, the title cannot be turned on or off using the remote control.

Date - Date Recording

The camcorder records the date with the picture all the time.



No Display - No Date Recording

The camcorder does not record the date.



Date and Time - Date and Time Recording

The camcorder records the date and time with the picture all the time.

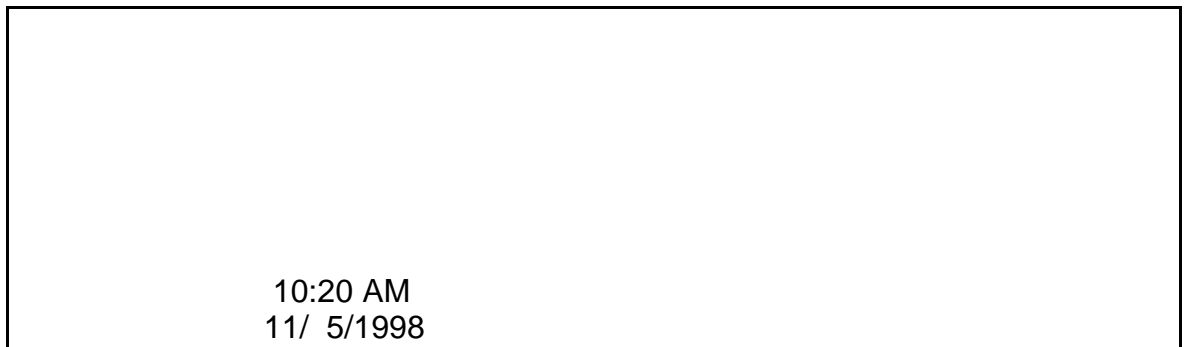

3. Press the start/stop button. Recording will start.

Note: When " AUTO" and date display is selected, the date disappears about 10 seconds after recording is started.

Note: When " TITLE" and date display is selected, the title and date disappear about 10 seconds after recording is started.

Digital Effects Recording

The digital processor in this camcorder allows you to record the picture and add special effects; 16x9 recording mode, a negative image (negative/positive recording), 130 times digital zoom feature, a symmetric image, obtained by placing a mirror at the center of the screen (half-mirror recording), and an image in mosaic (mosaic recording).

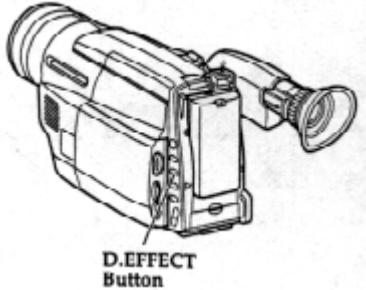

Note: The half-mirror recording and mosaic recording functions cannot be used with digital zoom, instant zoom, image stabilizer or zoom fade function.

- Each time the D.EFFECT button is pressed, the recording mode is switched.

16x9

16X9 Mode

NEGPOS

Negative/Positive Mode

ZM:2



X130 Digital Zoom Mode

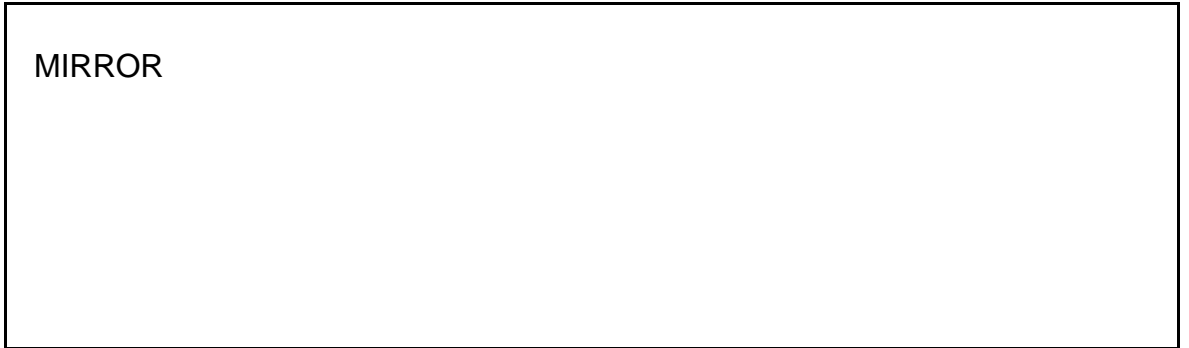

Half-Mirror Mode



Mosaic Mode



Normal Mode

(Returns to 16x9 Mode)

16x9 Mode Recording

The picture format can be switched from the 4:3 (the picture format of an ordinary TV

Advanced Techniques

set) to 16x9.

1. Place the camcorder in record pause.
2. Press the D.EFFECT button until "16x9" appears in the viewfinder or LCD monitor. The top and bottom of the picture in the viewfinder or LCD monitor become black bars.



3. Press the start/stop button to start recording.
 - To release the 16x9 mode, press the D.EFFECT button repeatedly in recording pause until normal mode is restored.

Negative/Positive Recording

1. Place the camcorder in record pause.
2. Repeatedly press the D.EFFECT button until "NEGPOS" appears in the viewfinder or LCD monitor.

The image in the viewfinder or LCD monitor will become negative.

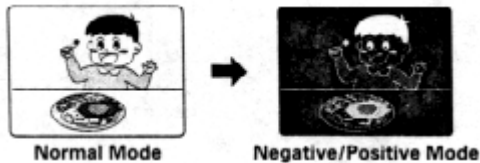

3. Press the start/stop button to start recording.
 - To release the negative mode, press the D.EFFECT button repeatedly in recording pause until normal mode is restored.

X130 Digital Zoom Recording

1. Place the camcorder in record pause.
2. Repeatedly press the D.EFFECT button until "ZM:2" appears in the viewfinder or LCD monitor.
3. Slide and hold the power zoom control to the "T" side until you reach your desired magnification.
4. Press the start/stop button to start recording.
 - To release the X130 digital zoom mode, press the D.EFFECT button repeatedly in recording pause until normal mode is restored.

Half-Mirror Recording

1. Place the camcorder in record pause.
 2. Repeatedly press the D.EFFECT button until "MIRROR" appears in the viewfinder or LCD monitor.
- The image in the viewfinder or LCD monitor will change to a symmetric image on the left and right, obtained by placing a mirror at the center of the screen.

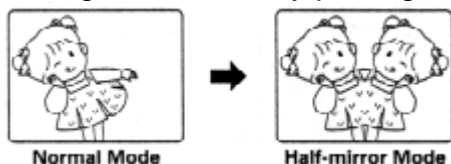

3. Press the start/stop button to start recording.
 - To release the half-mirror mode, press the D.EFFECT button repeatedly in recording pause until normal mode is restored.

Note: This function cannot be used with digital zoom, instant zoom, image stabilizer or zoom fade function.

Mosaic Recording

1. Place the camcorder in record pause.
2. Repeatedly press the D.EFFECT button until "MOSAIC" appears in the viewfinder or LCD monitor.

The image in the viewfinder or LCD monitor will be in mosaic.

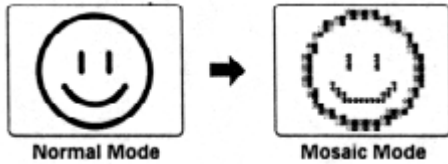

3. Press the start/stop button to start recording.
 - To release the mosaic mode, press the D.EFFECT button repeatedly in recording pause until normal mode is restored.

Note: This function cannot be used with digital zoom, instant zoom, image stabilizer or zoom fade function.

Using Fade

Use the fade feature to add a professional touch to your recordings. Use the FADE button to select one of the four fade options.

Note: If you press the D.EFFECT button after setting the fade function, the fade function will be released. After setting the digital effect mode, reset the fade function.

- **White fade:** Fades in from a white screen or fades out to a white screen. "  " appears in the upper left corner of the viewfinder or LCD monitor.

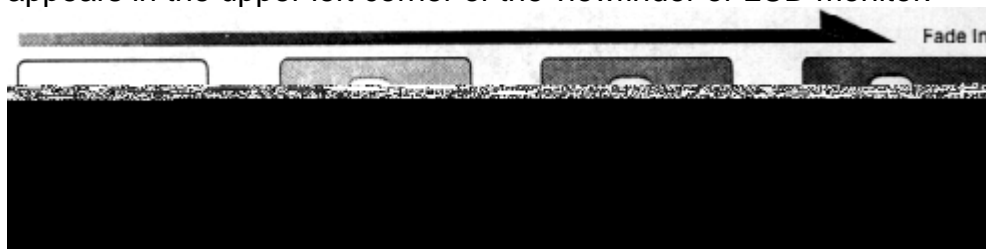

- **Wipe fade:** The picture opens gradually from the center of a black screen or closes into the center to a black screen. "  " appears in the upper left corner of the viewfinder or LCD monitor.



- **Zoom fade:** Fades in while zooming from a white screen or fades out while zooming

Advanced Techniques

to a white screen. " [] " appears in the upper left corner of the viewfinder or LCD monitor.



• **Black-and-White fade:** fades in from a black-and-white screen or fades out to a black-and-white screen. "B/W" appears in the upper left corner of the viewfinder or LCD monitor.



Fading In

1. Use the FADE button to select a fade option before recording.
2. Press the Start/Stop button to start recording; fade begins automatically.

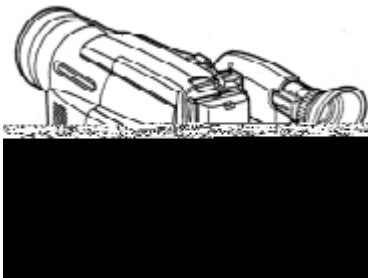

Fading Out

1. While recording with the camcorder use the FADE button to select a fade option.
2. Press the Start/Stop button to stop recording; the fade begins automatically and "REC" flashes until the fade ends.

Note: When fading out be sure to wait until the PAUSE indicator ([]) is visible in the viewfinder or LCD monitor before attempting to put the camcorder into the record mode again.

Using the Electronic Image Stabilizer (only for VM-E635LA)

The electronic image stabilizer (EIS) corrects slight shaking of the image being recorded and is effective in the following situations.



Advanced Techniques

- While you zoom to a distant subject.
- While you approach a small subject.
- While you walk around.
- While you record from inside a moving vehicle.

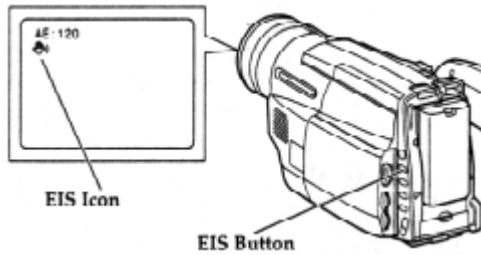

1. Press the EIS button. The EIS icon appears in the viewfinder or LCD monitor.
2. Press the Start/Stop button to start recording. When EIS is engaged the viewfinder or LCD monitor image shakes with a slight delay.

Note: EIS may not function if you use a wide or tele converter lens.

Note: When the EIS function is engaged in the vicinity of the zoom range with "ZOOM" displayed in the viewfinder or LCD monitor, when moved from the wide-angle end, the image size will change, but this is normal.

Note: When the EIS function is engaged, the picture becomes rough.

Note: When the EIS function is engaged, the angle of view at the wide-angle end becomes narrower.

Note: It is recommended that you do not use the EIS function when using a tripod. The sensor would detect vibrations from the tripod in which case the picture would be blurred.

Using Quick Edit

Use quick edit to search for the end of previously recorded material, find a particular spot on your tape, begin editing, or record new material. While the camera is in record/pause mode hold down the F.FWD, REW/REVIEW, or PLAY button and visually search the tape. Release the button and the camcorder stops the tape at the exact position you selected.

Using the Display Button

Pressing the DISPLAY button on the remote control allows you to switch the displays in the viewfinder or to the LCD monitor.

Display in the viewfinder or LCD monitor in the VIDEO mode:

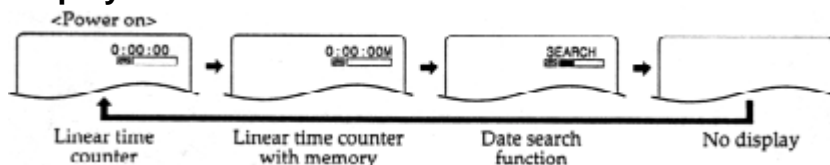

Display in the viewfinder or LCD monitor in the CAM mode:

Advanced Techniques

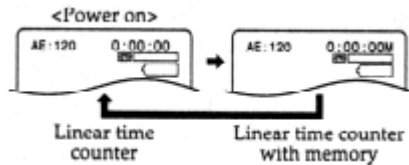

- When a recorded tape is in the camcorder during the VIDEO mode, "SEARCH" appears in the viewfinder or LCD monitor. (Refer to "Date Search" on page 41).

Note: The linear time counter with the memory feature and "SEARCH" in the viewfinder or LCD monitor can also be displayed on the connected television.

Note: If the LCD monitor is opened or closed (the picture is switched) during playback, the on-screen display in the picture will disappear for about one second, and then reappear again.

Note: When the date and time appear on the LCD monitor, you cannot erase them by pressing the DISPLAY button. If you want to erase the on-screen display, press the DATE/DISP. button on the camcorder.

Date Search

The date search function memorizes the start and end positions of recordings you made on a specific day so you can easily locate those positions later as long as the cassette is left in the camcorder.

Note: Be sure that the date and time are set.

1. Attach a power source and slide the CAM/OFF/VIDEO switch to VIDEO.
2. Press the DATE/DISP. button (the DISPLAY button on the remote control) to display "SEARCH" in the viewfinder or LCD monitor.



3. Press the REW/REVIEW button to search for the start position from which you last made a recording or the F.FWD button to recording end position. "SEARCH" will appear while the start position is being searched for; "SEARCH ▶", while the end position is being searched for.
4. When the required position is located, the camcorder enters the stop mode and "SEARCH" disappears from the viewfinder or LCD monitor.



Note: If you have ejected the cassette, this function will not operate with that cassette. (When a cassette is inserted and the recording is started, the position is identified as the recording start position on that day.)

Note: If the clock battery is not inserted, the date search function does not operate when the battery providing the power to the camcorder is removed.

Note: When the cassette was recorded by another camcorder, the date search function

Advanced Techniques

does not operate.

Note: The date search function is released when you press the STOP button during date search mode.

Note: If the recorded time is less than 30 seconds, the date search function may not operate normally.

Using Memory

The linear time counter memory stops a rewinding tape at approximately 0:00:00M. This feature helps in locating a specific point in the tape to which you wish to return. An example might be that you have recorded some tape that you have already watched, you continue recording but do not care to watch the tape you recorded earlier. The memory feature returns you to the beginning of the most recent recording.

1. Start recording or playback of a cassette. Press the COUNTER RESET button on the remote control at the point to which you wish to return. The linear time counter clears to "0:00:00".
2. Press the STOP button to stop playback, or press the start/stop recording and set the CAM/OFF/VIDEO switch to VIDEO.
3. Press the DISPLAY button on the remote control so the linear time counter with memory is displayed as shown in the figure.
4. Press the REW/REVIEW button and the tape stops at approximately where you reset the linear time counter. This feature works in F.FWD as well.

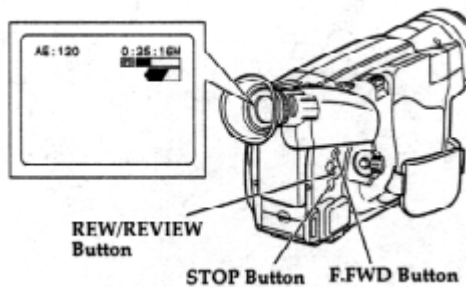

Using the Wireless Remote Control

Use the wireless remote control to operate the camcorder from a distance. The PLAY, F.FWD, REW, STOP, PAUSE (START/STOP) and ZOOM buttons on the wireless remote control operate the functions of the corresponding buttons on the camcorder. Aim the wireless remote control at the infrared receiver of the camcorder.

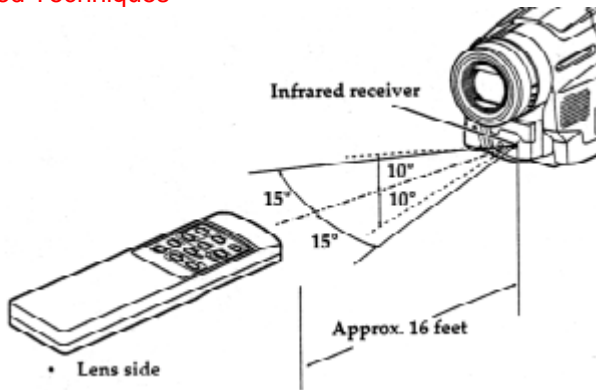

Note: Use the wireless remote control within the range of the infrared receiver of the camcorder shown above.

Note: The wireless remote control may not function in strong light such as direct sunlight or very bright artificial lighting.

Note: Clear a direct path from the wireless remote control to the infrared receiver. The wireless remote control won't work if an obstacle blocks the infrared rays.

Note: The remote control code of this camcorder is Hitachi code VCR2. If you have a VCR with the same code your Hitachi VCR may malfunction when you use the camcorder's wireless remote control.

Attaching the Optional Wide or Tele Converter Lens

Screw the lens into the threads on the camcorder lens assembly.

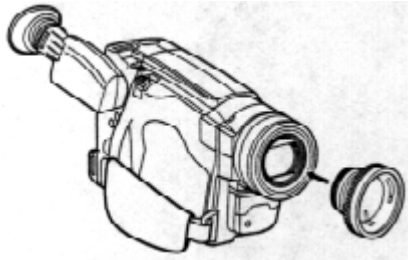

Creating and Recording A Title

Create titles easily and personalize your recordings while keeping a permanent visual record of what is contained on a tape. The camcorder can store a title in its memory. A title stored in memory can be displayed and recorded at any time. A title contains two lines of up to 16 characters per line. The camcorder contains 47 different characters for creating a title. When creating and recording a title, use the TITLE ON/OFF button on the remote control. (When creating a title in the CAM mode, the DATE/DISP. button of the camcorder can be used instead of the TITLE ON/OFF button on the remote control. " TITLE " should be displayed in the viewfinder or LCD monitor at this time.)

Note: Be sure to insert the clock battery before creating a title. Although a title can be created without the clock battery inserted, it will disappear when the battery providing power to the camcorder is removed.

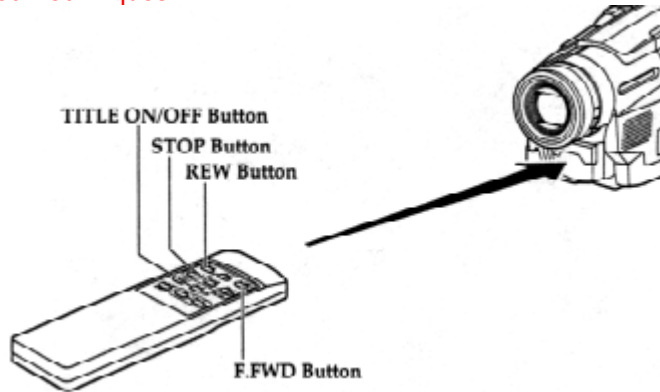

Creating a Title

1. Connect the camcorder to a power source.
2. Hold down the red button on the CAM/OFF/VIDEO switch and slide it to either CAM or VIDEO.
3. Press the TITLE ON/OFF button on the remote control and a flashing cursor appears in the viewfinder or LCD monitor.

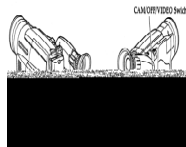

4. Use the STOP button to place the cursor where you wish to begin your title.
5. Use the F.FWD and REW buttons to select the first character of your title.



6. Once you've selected a character press the STOP button to set it.

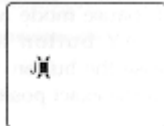

7. Complete the title by repeating steps 5 and 6.

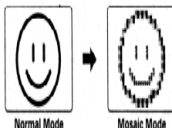

8. When you complete your title, press the TITLE ON/OFF button on the remote control to store the title in memory and remove the title graphics from the viewfinder or LCD monitor.

Note: As long as the correct current time can be displayed, the title is held in memory.

Characters available for your title.

A	B	C	D	E	F	G	H	I	J	K	L	M	N	O	P
Q	R	S	T	U	V	W	X	Y	Z	0	1	2	3	4	5
6	7	8	9	?	'	.	/	,	-	;	:	<	>	!	

Correcting Errors

1. Press the TITLE ON/OFF button on the remote control.

Advanced Techniques

2. Use the STOP button to select the character to be corrected.
3. Use the F.FWD and REW buttons to correct the character.
4. Press the TITLE ON/OFF button on the remote control to store the corrected title in memory.

Recording Title on a Tape in the Camcorder

1. Hold down the red button on the CAM/OFF/VIDEO switch while sliding the switch to CAM.
2. Locate the point of the tape where you wish to record the title ("Using Quick Edit," p40).
3. Press the TITLE ON/OFF button on the remote control.
4. Press the Start/Stop button to start recording the title.
5. Press the TITLE ON/OFF button on the remote control to stop recording the title. The title graphics disappear from the viewfinder or LCD monitor and the camcorder can record normally.

Note: Create and store your title before an event you plan to record. Just press the TITLE ON/OFF button on the remote control to superimpose the title over the scene as you record it. This method avoids erasing previously recorded material which will happen when you record a title on a previously recorded tape.

Recording a Created Title while Transferring a Tape

1. Connect the camcorder to the VCR (p30).
2. Turn on the VCR and set it to record. Hold down the red button on the CAM/OFF/VIDEO switch while sliding the switch to VIDEO. Press PLAY on the camcorder.
3. Press the TITLE ON/OFF button on the remote control at the point on the tape where you wish to record the title.
4. Press the TITLE ON/OFF button on the remote control again to stop recording the title.

Note: Recording the title during tape transfer will erase a portion of your recorded material.

Dubbing from the Camcorder to a VCR

Connect the camcorder to a VCR to copy your or a friend's home 8mm recordings to VHS.

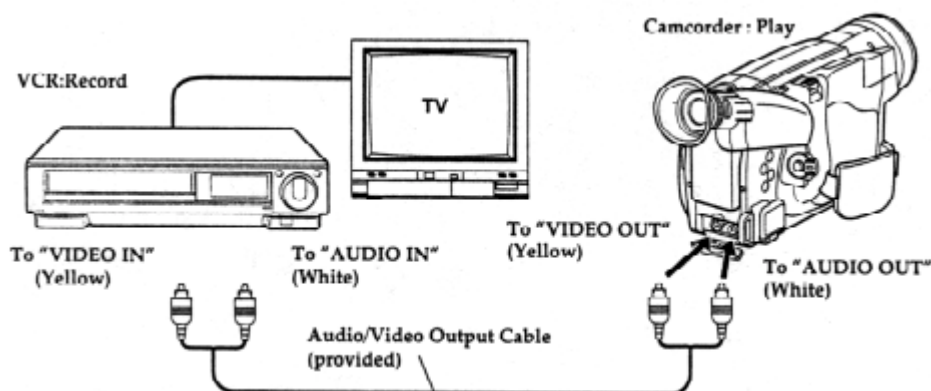

Advanced Techniques

1. Connect your camcorder to the VCR, following "Playing Back Your Recording" on page 30.
2. Turn on your VCR and place it in the camcorder input mode (consult your VCR manual for details). Operate the television as you normally do to see the signal coming from the VCR.
3. Hold down the red button of the CAM/OFF/VIDEO switch while you slide the switch to VIDEO.
4. Insert the recorded tape in the camcorder and a blank tape into the VCR. Set the VCR to record.
5. Play the tape from the camcorder while recording on the VCR.

Note: If the VCR is connected to a television and the VCR/TV selector is set to VCR, you can monitor the tape being dubbed.

Note: Reduce the volume of the camcorder as low as possible during dubbing. Otherwise the played back pictures could be distorted.

Simple Programmable Edit (Edit remote control is optional accessory)

Simple programmable edit allows you to program your camcorder to select the scenes you want to copy from a pre-recorded tape. Use the edit remote control (optional) to easily copy scenes from a recorded tape in the camcorder (playback machine) onto a blank tape in a table-top VCR which handles infrared signals (recording machine).

Note: Only the VM-RM20EDA edit remote control (optional) can be used with this camcorder.

Note: Some VCRs cannot be operated by the edit remote control (optional).

Example of Programmable Editing

Programming the Remote Control for the VCR

It is necessary to program the edit remote control to match the VCR before starting editing.

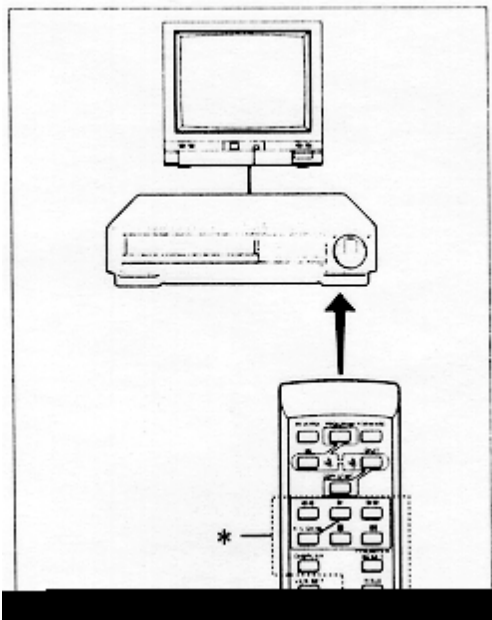

Advanced Techniques

1. Turn the VCR on.
2. Aim the remote control at the infrared receiver on the VCR and press the VCR SET button on the remote control and hold it, then press the button corresponding to the VCR's maker code. For example, if you have a RCA VCR, press the VCR SET button and hold it, then press the DISPLAY button. To check whether the remote control code matches that of your VCR or not, point the remote control at the infrared receiver on the VCR and press the VCR SET button and hold it. If the remote control code has been set, the VCR channel is counted up automatically.

Note: Your VCR should have an infrared remote control.

Note: If the channel on the VCR does not change with the above operation, you need to switch the remote control code of your VCR. Refer to the VCR's instruction manual. If the channel still does not change after you have changed the VCR's remote control code, the edit remote control cannot operate your VCR.

VCR Brands	Press VCR SET and This Button
Hitachi	REVERSE
Sony	PROGRAM
Panasonic	FORWARD
Toshiba	IN
Mitsubishi	COPY START
Sanyo	OUT
Sharp	◀
NEC	▶
JVC	▶▶
Akai	A/V DUB
Gold Star	■
PHILIPS	
RCA	DISPLAY
Zenith	COUNTER RESET
Magnavox	TITLE ON/OFF

Note: The remote control code is held in memory until it is changed or the batteries are replaced.

Note: Point the remote control straight at the VCR's infrared receiver for operation.

Note: Use the remote control indoors. When the infrared receivers of the VCR and camcorder are exposed to direct sunlight or strong artificial light, the remote control may not operate correctly.

Note: The remote control cannot be operated if there is an obstacle between the remote control and infrared receiver. Especially, be careful of this during dubbing.

Advanced Techniques

Note: When the edit remote control is connected to the camcorder, the buttons marked * in the figure above perform the same operations as those of the other remote control provided.

Operation

You can select up to four different scenes or segments to be copied at one time.

Note: If sunlight or strong artificial light strikes the camcorder's infrared receiver, the editing operation may not be possible.

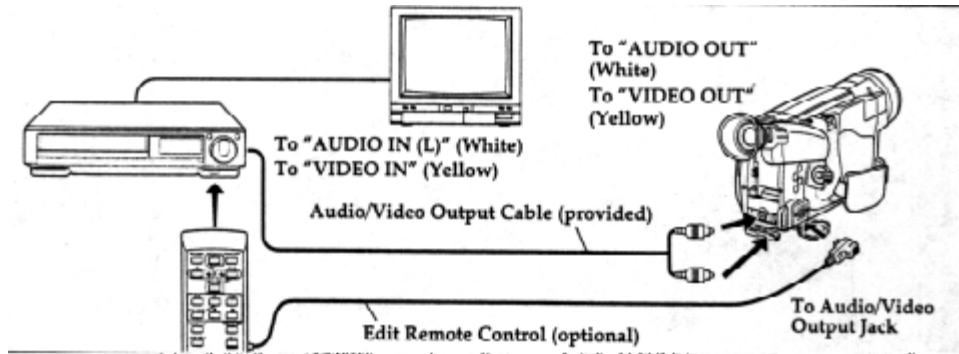

1. Connect the edit remote control to the camcorder, and then connect the audio/video output cable as illustrated above.

Note: If your VCR has two (stereo) AUDIO IN jacks, connect the audio plug to the left-channel AUDIO IN jack.

2. Insert a recorded tape into the camcorder.
3. Set the CAM/OFF/VIDEO switch of the camcorder to VIDEO. Turn the recording VCR on and select line input.
4. Press the PROGRAM button of the remote control. The program display appears in the viewfinder.

```
PROG. 1 0:00:02
IN      -:-:-:-
OUT     -:-:-:-
```

Note: If your VCR is connected to a TV, the program display will also appear on the TV screen.

5. Press the \blacktriangleright button and use the $\blacktriangleright\blacktriangleright$ or $\blacktriangleleft\blacktriangleleft$ button to search for the starting point of the segment you want to copy. Press \blacktriangleright and then \blacksquare to set the camcorder to the play pause mode.
The linear time counter counts when searching for the starting point.
Use the FORWARD and REVERSE buttons in the play or pause mode to fine adjust the

Advanced Techniques

tape position. Press FORWARD and hold it; the tape is played while the button is held. Press REVERSE and hold it for reverse play.

6. Press the IN button to store the counter reading. When you press the IN button, OUT flashes in the program display.

```
PROG. 1 0: 15 : 13
IN      0: 15 : 13
OUT     -: - : - -
```

7. Press the ► button to search for the end of the segment you want to copy. Press ► and then ■■ to set the camcorder to the play pause mode. Use the FORWARD or REVERSE button as required to fine adjust the tape position.

8. Press the OUT button to store the counter reading at the end of the scene.

```
PROG. 2 0: 20 : 15
IN      -: - : - -
OUT     -: - : - -
```

9. Continue programming as described above until you have entered up to four different segments.

10. Load a blank tape, then set the VCR to the record pause mode.

11. Point the remote control at the receiver on the VCR and press the COPY START button to start simple programmable edit.

- The camcorder automatically searches for the beginning of the first segment and starts playback. The recording VCR automatically starts recording

- After recording the first segment, the camcorder automatically searches for the beginning of the next segment and resumes playback. The recording VCR is automatically released from the record pause mode and resumes recording.

- It continues recording and pausing until all the programmed segments are edited.

12. When simple programmable edit is finished, the camcorder will enter the stop mode, and the VCR will enter the record pause mode.

Note: If you make a mistake during programming, start again from the beginning or press the COUNTER RESET button to return to the previous steps one by one and enter the correct program data.

Note: After the simple programmable edit is finished, the programmed data is erased. If you want to continue editing other segments, repeat steps 5 - 12.

Note: Most VCRs (recording machine) may be released from the record pause mode if it

Advanced Techniques

continues for more than five minutes.

Note: The dubbing start and end positions may slightly drift from the specified positions when certain VCRs are used.

Note: Reduce the volume of the camcorder as low as possible during dubbing. Otherwise the played back pictures could be distorted.

To End Programmable Simple Edit

Press the PROGRAM button to remove the program display from the viewfinder or the LCD monitor. Then press the stop button on the recording VCR to set it to the stop mode.

Note: If the CAM/OFF/VIDEO switch of the camcorder is set to OFF or CAM when the recording VCR is in the record pause mode, the VCR enters the record mode.

Using Audio/Video Dubbing

Use audio/video dubbing to record audio and video from the camcorder's built-in microphone and camera onto a previously recorded tape in the camcorder.

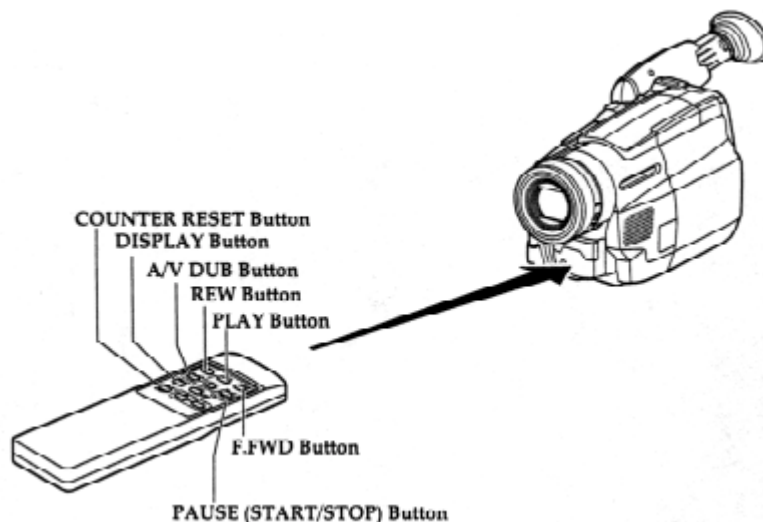

1. Connect your camcorder to the television, following "Connecting to a Television with Audio In and Video In Jacks" on page 31.
2. Turn on your television and place it in the camcorder input mode (consult your television manual for details).
3. Hold down the red button on the CAM/OFF/VIDEO switch while sliding the switch to VIDEO.
4. Insert a previously recorded tape in the camcorder.
5. Use the wireless remote control and press the PLAY button. Use the PLAY, F.FWD, and REW buttons to find the place where you want to stop dubbing. Press the PAUSE (START/STOP) button.
6. Display the linear timer counter with memory ("Using Memory," p.41). Press the COUNTER RESET button to set the linear time counter to "0:00:00M".
7. Use the REW and PLAY buttons to find where you wish to start dubbing. Press the PAUSE (START/STOP) button.
8. Press and hold the A/V DUB button while pressing the PLAY button. This places the

Advanced Techniques

camcorder in A/V DUB pause mode.

9. Press the PAUSE (START/STOP) button. The audio/video dubbing starts. When the linear time counter reaches "0:00:00M" the camcorder stops automatically, recording only the portion of the tape that you selected.

Note: If the camcorder is in AV DUB pause or STILL mode for more than 5 minutes, the camcorder stops automatically to protect the tape.

Note: Automatic date recording is disabled during audio/video dubbing.

Note: When the audio/video dubbed portion is played back, noise may appear at the end of the dubbed portion.

General Maintenance

Cleaning the Camcorder Heads

Dirt can accumulate on the video heads on the camera causing the playback picture to become blurred or appear as if video information is lost. This often means that the video heads are dirty. Use a video head cleaner such as a dry type head cleaning tape to clean the heads.

If after cleaning the heads the picture does not clear up consult your nearest dealer or VCR service center for professional head cleaning.



Cleaning the Lens and Picture Tube of the Electronic Viewfinder

The lens of the electronic viewfinder can be user-cleaned if dust, dirt, or other foreign matter adheres to it.

1. Pull out the eye cup to the position where a mark can be seen (up to a half where it can be pulled out all the way). The side with the mark should be up.

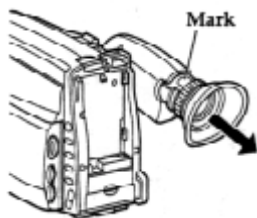

2. Turn the eye cup counterclockwise until it stops, then pull it out to remove.

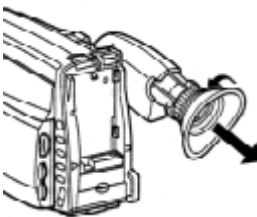

3. Clean the picture tube face and lens. To prevent scratching, use a soft non abrasive cloth, swab or lens cleaning paper.

General Maintenance

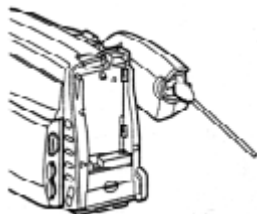

4. Face the rib up as shown above and push the eye cup in until it stops.

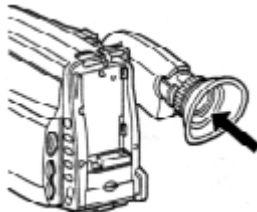

5. Turn the eye cup clockwise until it stops, then push it in all the way.

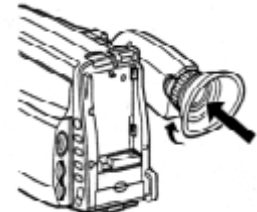

Periodic Maintenance

A precision electromechanical device, the Hitachi VM-E535LA/VM-E635LA requires maintenance after a period of normal use. We expect that no other maintenance other than head cleaning will be required during the period of warranty unless the camcorder is used either heavily or seldom. Defective parts are covered by the warranty. Normal maintenance is the responsibility of the owner. Consult your dealer or local VCR service center for recommendations regarding normal maintenance based on your use patterns, location, and the age of the camcorder.

Troubleshooting

Quality is very important at Hitachi. We inspect and check every camcorder carefully at the factory under the most rigid quality control and inspection systems. If problems develop please check the following possible solutions before inquiring about professional service.

INSERTING OR REMOVING THE CASSETTE

Symptom	Check Point & Correction
Cassette holder cannot be opened when you press EJECT switch.	Connect the power source.
	Open the LCD monitor then slide the EJECT switch.
Cassette cannot be inserted into cassette	Load cassette in direction indicate by arrow

General Maintenance

compartment.	on cassette.
	Cassette window must be toward outside.

CAMERA RECORDING

Symptom	Check Point & Correction
Picture does not appear in the viewfinder or LCD monitor.	Open the lens door.
	Slide the CAM/OFF/VIDEO switch to CAM.
The camcorder cannot go into the recording mode, even when the start/stop button is pressed.	Check the record protect tab on the cassette.
	Push the cassette holder embossed PUSH LOCK to close it.
	Slide the CAM/OFF/VIDEO switch to CAM.
Picture is out of focus.	Make sure that "FOCUS" does not appear in the viewfinder or LCD monitor.
Auto-focus does not operate.	Auto focus does not operate if a special effects filter is attached.
The created title does not appear.	Insert the clock battery, then create a title.
	Do not remove the clock battery after creating a title.



PLAYBACK OF PRE-RECORDED CASSETTE

Symptom	Check Point & Correction
The PLAY button cannot be engaged.	Set the CAM/OFF/VIDEO switch to VIDEO>
No picture appears on television screen when the play button is pressed.	Set the television to the camcorder channel (3 or 47) depending upon the selected channel in the RF channel select switch of the RF output adapter.
Interference on playback picture.	When you see the playback picture on your TV, adjust fine tuning knob on television set to obtain best picture.
Picture bends at the top of the TV screen.	TV receiver is older type, it needs to be modified to work properly with camcorder.
	Tape is damaged. Try another cassette.
Color of your TV screen is too bright, too faint or change.	TV set has VIR circuit. Turn it off during playback.
Date search function does not operate.	Slide the CAM/OFF/VIDEO switch to VIDEO.
	Insert the clock battery, set the date and time, then start recording.

General Maintenance

	Do not remove the clock battery after recording.
	Do not eject the recorded cassette. Leave it in the camcorder.

BATTERY CONDITION

Symptom	Check Point & Correction
The () indication in the electronic viewfinder flashes to indicate battery is discharged.	Try another battery or charge the battery.
The battery level indicator () appears differently on the LCD monitor and in the viewfinder.	This does not indicate a fault, it is because the power consumer by the LCD monitor and viewfinder is different.

NO OPERATION IS ACCEPTED

Symptom	Check Point & Correction
Power is turned on but no button operations are accepted.	Remove the power source and the date/title battery. After about one minute, the display in the viewfinder or LCD monitor will be reset. Then set the information again.

TAPE DISPLAY

Symptom	Check Point & Correction
"TAPE" appears in the viewfinder or LCD monitor.	Have you moved the camcorder or cassette from a cold place to a warm place so that its temperature changed abruptly?

Specifications

General Specifications

Power requirements	7.2V DC
Power consumption	4.3W (when recording/LCD monitor OFF) 5.4W (when recording/LCD monitor ON)
Dimensions	4-1/8" W x 4-1/2" H x 9-7/16" D (104mm x 115mm x 239mm)
Weight	2.03 lbs (approx. 920g) without battery pack or cassette
Operating temperature	32°F ~ 104°F (0°C ~ 40°C)
Storage temperature	-4°F ~ 140°F (-20°C ~ 60°C)

Video Recorder Specifications

Format	8mm
Record/playback	Two video record/playback heads
Video signal	EIA standard NTSC color
Tape speed	14.3mm/sec
Video input	1.0Vp-p, 75 ohm
Video output	1.0Vp-p, 75 ohm
Audio input	-7.8dBs (316mVrms)
Audio output	-7.8dBs (316mVrms)
Fast forward/rewind time	Less than 8 minutes with P6-120 cassette

Camera Specifications

Scanning	525 lines/60 fields/30 frames
Required minimum illumination	0.8 lux (4 lux measured by EIA method)
Pickup device	1/4" C.C.D.
Lens diameter	46mm

For U.S.A. only

HITACHI

Service Hotline

To locate an authorized
HITACHI service facility
in the continental U.S.A.

DIAL TOLL FREE

7 days a week, 24 hours a day

800 HITACHI

1-800-448-2244

Hitachi Home Electronics (America), Inc.

Hitachi has made every effort to assure you hours of trouble free operation from your unit. However, should you require service, a network of Hitachi Authorized Service Facilities has been established in all 50 states and Puerto Rico. Each facility will provide you with convenient and expedient assistance. Our service "Hotline" operator will direct you to the Hitachi Authorized Service Facility nearest you. Just present proof of purchase and/or delivery receipts to the Hitachi Authorized Service Facility and service will be rendered in accordance with the terms of the limited warranty as stated on your warranty card or operating guide.

General Maintenance

Should you have any questions regarding in-warranty service, operation or technical assistance, please contact:

Hitachi Home Electronics (America), Inc.

3890 Steve Reynolds Blvd
Norcross, GA 30093
Tel 770-279-5600

Hitachi Sales Corporation of Hawaii

3219 Koapaka St./Honolulu, HI 96819
Tel 808-836-3621

We know that once you discover how much your Hitachi VM-E535LA/VM-E635LA can add to your life you will want to use these accessories for even more excitement. Converter lenses, adapters for synchro editing, and car cords are just a few of the exciting accessories available to you from Hitachi. Hitachi takes you to wherever your imagination leads.

Available Accessories

Click to see Available Accessories

More Available Accessories

To place an order for any of these items call our toll free number or use the ordering form on page 59.

1-800-995-4500

To Order in the United States

By Phone

To place an order by phone, have your VISA, MASTERCARD, or DISCOVER card ready and call the toll-free number (8:00AM ~ 6:00PM East Coast Time - workdays).

1-800-995-4500

In Canada - Please use Canadian order form in French version of this manual - Page 59.

By Mail

Complete the order form on page 59. Detach it and send it to the following address with your credit card information, money order, or check (in U.S. currency and payable to HiTRON, Inc.).

HiTRON is a subsidiary of Hitachi Home Electronics (America), Inc.

HiTRON, Inc.

**675, Old Peachtree RD.
Suwanee, GA 30174**

Please allow two to three weeks for delivery. If there is a current back order status on the model(s) you ordered, we will notify you.

Thank you for allowing us (Hitachi and HiTRON) to be of service to you...our valued customer!

FOR AUTHORIZED HITACHI SERVICE IN CANADA

General Maintenance

Please consult the following telephone number:

Montreal (514) 956-9882

Toronto (905) 821-4545

Vancouver (604) 214-0777