

Instant Broadband™ Series

EtherFast® Cable/DSL & Voice Router powered by Net2Phone



Use this Guide to install: **BEFN2PS4**

User Guide

 **LINKSYS®**

COPYRIGHT & TRADEMARKS

Copyright © 2000 Linksys, All Rights Reserved. Instant Broadband is a registered trademark of Linksys. Microsoft, Windows, and the Windows logo are registered trademarks of Microsoft Corporation. All corporate names, service marks, logos, trade names, trademarks, websites and domain names of Net2Phone (collectively "Marks") are and shall remain the exclusive property of Net2Phone and nothing in this agreement shall grant you the license to use such Marks. All other trademarks and brand names are the property of their respective proprietors.

LIMITED WARRANTY

Linksys guarantees that every Instant Broadband EtherFast Cable/DSL & Voice Router powered by Net2Phone is free from physical defects in material and workmanship under normal use for one (1) year from the date of purchase. If the product proves defective during this warranty period, call Linksys Customer Support in order to obtain a Return Authorization number. BE SURE TO HAVE YOUR PROOF OF PURCHASE ON HAND WHEN CALLING. When returning a product, mark the Return Authorization number clearly on the outside of the package and include your original proof of purchase. RETURN REQUESTS CANNOT BE PROCESSED WITHOUT PROOF OF PURCHASE. All customers located outside of the United States of America and Canada shall be held responsible for shipping and handling charges.

IN NO EVENT SHALL LINKSYS' LIABILITY EXCEED THE PRICE PAID FOR THE PRODUCT FROM DIRECT, INDIRECT, SPECIAL, INCIDENTAL, OR CONSEQUENTIAL DAMAGES RESULTING FROM THE USE OF THE PRODUCT, ITS ACCOMPANYING SOFTWARE, OR ITS DOCUMENTATION. LINKSYS OFFERS NO REFUNDS FOR ITS PRODUCTS. Linksys makes no warranty or representation, expressed, implied, or statutory, with respect to its products or the contents or use of this documentation and all accompanying software, and specifically disclaims its quality, performance, merchantability, or fitness for any particular purpose. Linksys reserves the right to revise or update its products, software, or documentation without obligation to notify any individual or entity. Please direct all inquiries to:

Linksys P.O. Box 18558, Irvine, CA 92623.

FCC STATEMENT

The Instant Broadband EtherFast Cable/DSL & Voice Router powered by Net2Phone has been tested and found to comply with the limits for a Class B digital device, pursuant to Part 15 of the FCC Rules. These limits are designed to provide reasonable protection against harmful interference in a residential installation. This equipment generates, uses, and can radiate radio frequency energy and, if not installed and used according to the instructions, may cause harmful interference to radio communications. However, there is no guarantee that interference will not occur in a particular installation. If this equipment does cause harmful interference to radio or television reception, which is found by turning the equipment off and on, the user is encouraged to try to correct the interference by one or more of the following measures:

- Reorient or relocate the receiving antenna
- Increase the separation between the equipment or device
- Connect the equipment to an outlet other than the receiver's
- Consult a dealer or an experienced radio/TV technician for assistance

UG-BEFN2P4S-01219NC DG

Table of Contents

Introduction	1
About Net2Phone	1
Features	2
Package Contents / System Requirements	3
Getting to Know the Cable/DSL Voice Router	4
The Cable/DSL & Voice Router's Rear Panel	4
The Reset Button	5
The Cable/DSL & Voice Router's Front Panel LEDs	6
Connecting Your Cable/DSL Voice Router to Your Network	8
Overview	8
About Static & Dynamic IP Addresses	8
Connecting Everything Together & Booting Up	9
Configuring Your PCs to Connect to the Cable/DSL & Voice Router	11
Configuring Your Network with the Cable/DSL & Voice Router	13
Setting Up Your Net2Phone Account	18
The Cable/DSL Voice Router's Web-based Utility	20
Quick and Easy Administration	20
Basic Features	21
Advanced Features	29
Troubleshooting	37
Common Problems and Solutions	37
Frequently Asked Questions	38
Net2Phone Troubleshooting / Frequently Asked Questions	43
Appendix	45
How to Ping Your ISP's E-mail & Web Addresses	45
Installing the TCP/IP Protocol	48
Twisted-Pair Cabling	50
Crimping Your Own Network Cables	51
Cable/DSL & Voice Router Specifications	52
Environment	52
Warranty Information	53
Contact Information	54

Introduction

The Linksys EtherFast Cable/DSL & Voice Router

Congratulations on your purchase of a Instant Broadband EtherFast Cable/DSL & Voice Router powered by Net2Phone. The Instant Broadband EtherFast Cable/DSL & Voice Router powered by Net2Phone is the perfect solution for connecting a small group of PCs to a high-speed broadband Internet connection or a 10/100 Ethernet backbone—and it features Voice Over IP telephone calls powered by Net2Phone. With the Router installed, no other special hardware is necessary for telephone calls. An ordinary telephone connects to the RJ-11 port (telephone jack) on the back of the Router, and calls are routed by Net2Phone's superior quality network to anywhere in the world—significantly reducing long distance charges.

Configurable as a DHCP server for your existing network, the EtherFast® Cable/DSL & Voice Router acts as the only externally recognized Internet gateway on your local area network (LAN). The Router can be configured to filter internal users' access to the Internet and serve as an Internet firewall against unwanted outside intruders. In addition to making Internet access available for up to 253 PCs on the network, it adds an additional voice phone line for outgoing calls at no additional cost. None of your PCs even have to be turned on to make calls. The EtherFast® Cable/DSL & Voice Router handles all of your network and telephony needs in one integrated unit.

About Net2Phone

Net2Phone is a leading provider of voice-enhanced Internet communications services to individuals and businesses.

Recognized as the company that first bridged the Internet with the public switched telephone network, Net2Phone routes millions of minutes daily over the Internet. Using its advanced IP (Internet Protocol) network and technologies, Net2Phone routes voice and other value-added applications worldwide. Internet calls are less expensive than traditional phone calls primarily because these calls are routed over the Internet. Bypassing much of the traditional phone network makes it possible for Net2Phone to provide incredibly low rates for the millions of calls it delivers worldwide.

Features

- Connects to a Broadband Modem and an 10/100 Ethernet Backbone
- One Low Rate For All Domestic Phone Calls
- Uses an Ordinary Telephone to Make Internet Calls
- Use Just One IP Address to Access the Internet Over Your Entire Network
- Configurable Through Your Networked PC's Web Browser
- Supports IPSec and PPTP Pass-Thru
- Remote Administration and Remote Firmware Upgrades Over the Internet
- Internal 4-Port Switch Dramatically Speeds Up Your Gaming and Multimedia Connections
- Acts as a DHCP Server for Your Existing Network
- Administrators Can Block Specific Internal Users' Internet Access with Filtering
- Supports PAP, CHAP, PPP, and PPPoE
- Net2Phone Web-based Account Management
- Supports Voice Over IP
- Free Technical Support—24 Hours a Day, 7 Days a Week for North America Only
- 1-Year Limited Warranty



Note: This product is for use in the United States and Canada only.



Package Contents

- One Linksys Instant Broadband EtherFast® Cable/DSL & Voice Router powered by Net2Phone
- One power adapter
- One Net2Phone Access Card (Not Shown)
- One TechHelper CD-ROM
- One user guide and registration card

System Requirements

- One RJ-45 Broadband Internet connection
- One PC with an installed 10Mbps, 100Mbps, or 10/100 Mbps Ethernet card
- One External Cable or DSL Modem
- TCP/IP network protocol for each PC
- UTP network cable with RJ-45 connector
- Microsoft Internet Explorer 4.0 or later, or Netscape Navigator 4.0 or later. (5.0 and 4.7, respectively, are strongly recommended.)

Getting to Know the EtherFast Cable/DSL & Voice Router

The Net2Phone Router's Rear Panel

The rear panel of the Router is where all of the Router's connections are made.



WAN The WAN (Wide Area Network) Port is where you will connect your cable or DSL modem.

Ports 1-4 These four LAN (Local Area Network) ports are where you will connect networked devices, such as PCs, print servers, remote hard drives, and anything else you want to put on your network. If Port 4 is being used, the Uplink Port will not work.

Uplink The Uplink Port is where you can expand your network by connecting to another switch or hub. The Uplink Port is shared with Port 4. Uplinking to another Router, switch or a hub is done by simply running a cable from the Uplink Port to the other device. If the Uplink port is being used, Port 4 will not work.

Phone The Phone Port is where you will connect your standard telephone.

Power The Power Port is where you will connect the included AC Power adapter.

The Reset Button*



Briefly pressing the Reset Button will refresh the Router's connections, potentially clearing any jammed links.

Pressing the Reset Button and holding it in for a few seconds will clear all of the Router's data and restore the factory defaults. This should be done only if you are experiencing heavy routing problems, and only after you have exhausted all of the other troubleshooting options. By resetting the Router, you run the risk of creating conflicts between your PCs' actual IP Addresses and what the Router thinks their IP Addresses should be. You may be forced to reboot the entire system(s).

If your router locks up, simply power it down for 3 to 5 seconds by removing the power cable from the Router's Power Port. Leaving the power off for too long could result in the loss of network connections.

The Cable/DSL Voice Router's Front Panel LEDs



The LAN Indicators

Net2Phone

In Use *Green.* The Net2Phone LED illuminates when there is an open phone connection.

Power *Green.* The Power LED illuminates when the Router is powered on.

Link/Act *Green.* The Link/Act LED serves two purposes. If the LED is continuously illuminated, the Router is successfully connected to a device through the corresponding port (1, 2, 3 or 4). If the LED is flickering, the Router is actively sending or receiving data over that port.

Full/Col *Green.* The Full/Col LED also serves two purposes. If this LED is continuously illuminated, the connection made through the corresponding port is successfully running in Full Duplex mode. If the LED is flickering, the connection is experiencing collisions. Infrequent collisions are normal. If this LED is flickering too often, there may be a problem with your connection. Check the Troubleshooting section if you think there is a problem.

100 *Orange.* The 100 LED illuminates when a successful 100Mbps connection is made through the corresponding port.

The WAN Indicators

Link *Green.* The Link LED illuminates when a successful connection is made between the Router and your Broadband device or network.

Act *Green.* The Act LED flickers when the Router is sending or receiving data over the broadband port.

Diag *Red.* The Diag LED illuminates when the Router goes through its self-diagnosis mode during boot-up. It will turn off upon successful completion of the diagnosis. If this LED stays on for an abnormally long period of time, refer to the Troubleshooting section.

Connecting the Cable/DSL Voice Router to Your Network

Overview

Unlike a simple hub or switch, the setup of the Cable/DSL Voice Router consists of more than simply plugging everything together. Because the Router acts as a DHCP server, you will have to set some values within the Router, and also configure your networked PCs to accept the IP Addresses the Router chooses to assign them.

You will need the following values from your ISP in order to install the Net2Phone Cable/DSL Router:

- Your account and PIN number from Net2Phone (to use their service)
 - Your broadband-configured PC's fixed Internet IP Address (if applicable)
 - Your broadband-configured PC's Computer Name and Workgroup Name
 - *Your Subnet Mask*
 - *Your Default Gateway*
 - *Your Primary DNS IP address*
- } *Only if applicable*

Whoever installed your broadband access should have left this information with you. If not, call your ISP and they will be able to supply you with it.

About Static & Dynamic IP Addresses

Static IP Addresses A static IP address is an IP address permanently assigned to computer in a TCP/IP network. Static IP addresses are usually assigned to networked devices which are consistently accessed by multiple users, such as Server PCs, or printers. If you are using your Router to share your cable or DSL Internet connection, contact your ISP to see if they have assigned your home a static IP address. You will need that address during your Router's configuration.

Dynamic IP Addresses A dynamic IP address is an IP address that is automatically assigned to a client station (computer, printer, etc.) in a TCP/IP network. Dynamic IP addresses are typically assigned by a DHCP server, which can be a computer on the network or another piece of hardware, such as the Router. A dynamic IP address may change every time your computer connects to the network.

DHCP (Dynamic Host Configuration Protocol) DHCP is software that automatically assigns IP addresses to client stations logging onto a TCP/IP network. DHCP eliminates having to manually assign permanent IP addresses to every device on your network. DHCP software typically runs in servers and is also found in network devices such as Routers.

Connecting Your Hardware Together and Booting Up

Once you are sure that you have the above values on hand, you can begin the Installation and Setup of your EtherFast Cable/DSL & Voice Router.

1. **Power everything down**, including your **PCs**, your **Cable** or **DSL** modem and the **Router**.
2. Connect a Network cable from one of your PCs' Ethernet ports to one of the LAN Ports on the back of the Router. Do the same with all the PCs you wish to connect to the Router. (LAN Port 4 will become inactive if you use the Uplink port.)
3. **Connect the network cable** from your Cable or DSL modem to the **WAN** port on the rear of the Router.

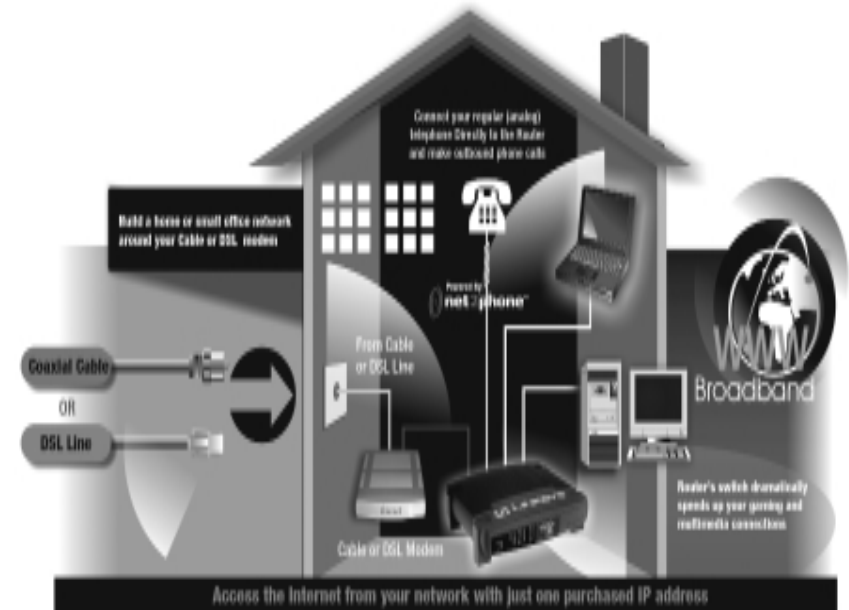

4. **Connect the power-supply cable** to the Power port on the rear of the Router, then plug the supplied AC power cable into a power outlet.

- The Power LED will illuminate green as soon as the power adapter is connected.
- The Diag LED will illuminate red for a few seconds while the Router goes through its internal diagnostic test. The LED will turn off when the self-test is complete.



Note: Some ISPs—most notably some cable providers—configure their networks so that you do not have to enter a full Internet address into your web browser or e-mail application to reach your home page or receive your e-mail. If your Internet home page address is something very simple, such as “www”, rather than “www.linksys.com”, or your e-mail server’s address is something similar to “e-mail” or “pop3”, rather than “pop.mail.linksys.com”, you won’t be able to properly configure your Cable/DSL & Voice Router until you determine the actual Internet addresses of your Web and e-mail connections.

You **must** obtain this information prior to connecting the Router to your network. You can obtain this information by contacting your ISP, or you can turn to page 36 to learn how to ping for an IP address.

5. **Power on the Cable or DSL modem.**

6. **Press the Reset button** on the front of the router. Hold the button in for three seconds, or until the Diag LED illuminates red. This restores the router’s default settings.

7. **Connect a Standard Phone Cord to the RJ-11 Port** on the Back of the Router. Connect the other end of the cord to your standard telephone. You will now be able to access the Voice Over IP features from this telephone.

The Hardware Installation is complete. Continue to the next page to configure your PCs and Router.

Configuring Your PCs to Connect to the Cable/DSL & Voice Router

Now that your Router is physically installed, you will have to configure your PCs to accept the IP addresses that your Router will provide.



These instructions apply only to Windows 95 and Windows 98 machines. For TCP/IP setup under Windows NT, please refer to your Microsoft Windows NT manual.

1. Click the **Start** button, select **Settings**, then **Control Panel**.
2. Double-click the **Network** icon.
3. In the **Configuration** window, select the **TCP/IP protocol line** that has been associated with your network card/adapter.

Note: If the TCP/IP protocol is not configured on your PC, go to the Appendix for TCP/IP installation instructions now.

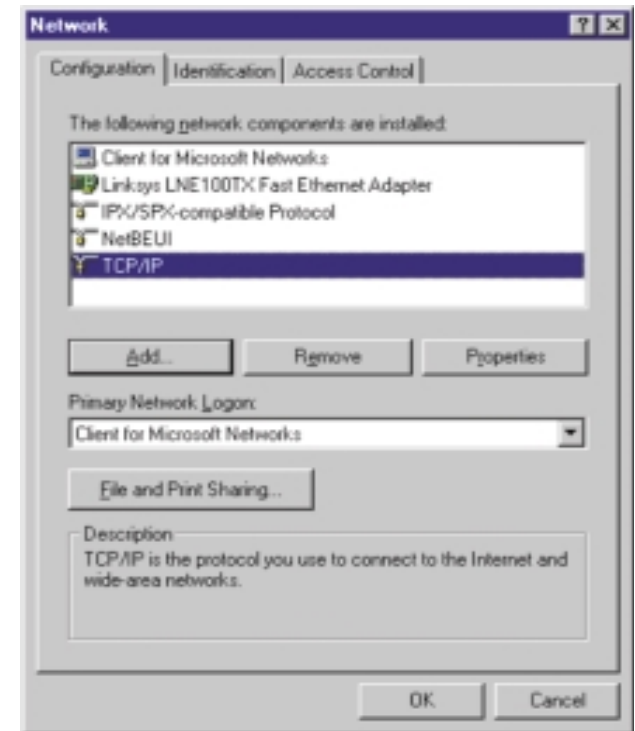

4. Click the **Properties** button, then choose the **IP Address** tab. Select **Obtain an IP address automatically**. Click on the **Gateway** tab and make sure that all fields there are empty.



5. Click **OK**. All client settings are complete. Windows may ask for original Windows installation files. Supply them as needed (i.e.: D:\win98, D:\win95, D:\win9x, c:\windows\options\cabs.)
6. Windows will ask you to restart the PC. Click **Yes**.

Repeat steps 1-6 for each PC on your network. When all of your PCs are configured, continue on to set up the router using the router's Web-based Utility.

Configuring Your Network with the Cable/DSL & Voice Router

Configuring the Cable/DSL & Voice Router

Now that your Cable/DSL & Voice Router is wired into your network, you can begin configuring your system.

1. **Open your web browser** and type `http://192.168.1.1` in the browser's Address box. This number is the default IP address of your router. Press **Enter**.

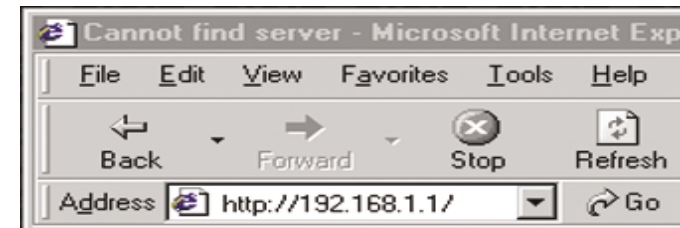

Note: If you have previously enabled an Internet Sharing Proxy Service on any of your PCs, you must disable it now.

- If you are running Netscape Navigator: Click **Edit >> Preference >> Advanced >> Proxies** and click **Direct Connection to the Internet**.
- If you are running Internet Explorer v5 or better, click **Start >> Settings >> Control Panel >> Internet Options >> Connections >> LAN Settings**. Remove the checks from all three boxes. Click **OK** to continue.

2. A **username and password prompt** will appear. Leave the User Name box empty and type admin (the default password) in the **Password** box. Click **OK**.



3. The **Cable/DSL Voice Router's Setup** page will appear.

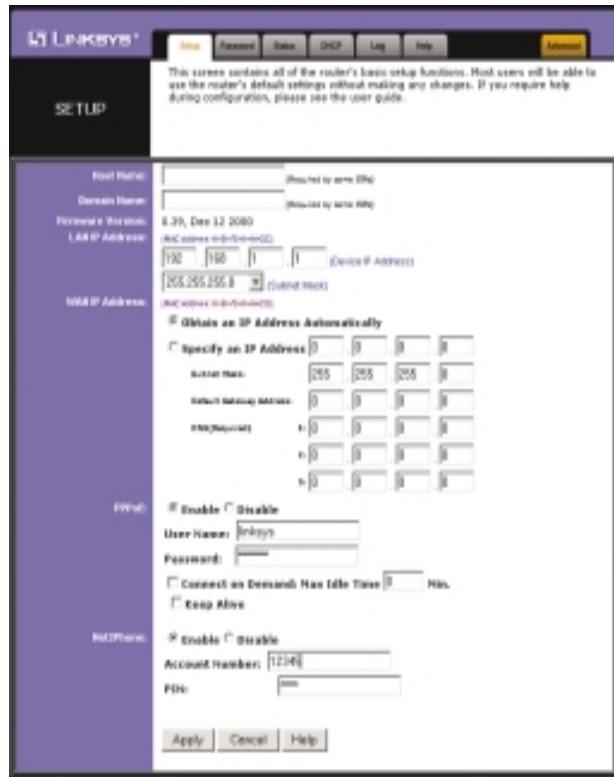

Note: The Setup page shown in this graphic may differ from the one seen on your router.

4. **Configure the following values.**

Note: All of this information should be readily available from your ISP.

Host Name & Domain Name These fields allow you to supply a host and domain name for the Router. Some ISPs require these names as identification. You may have to check with your ISP to see if your Broadband Internet service has been configured with a host and domain name. In most cases, leaving these fields blank will work.

LAN IP Address These values refer to your internal network settings. Unless you have specific internal needs, there should be no reason to change these values. For the internal LAN, the default values are as follows.

- Private IP Address: 192.168.1.1
- Subnet Mask: 255.255.255.0

WAN IP Address These values refer to the outside network you connect to every time you access your Broadband Internet connection. Most Broadband ISPs assign their clients with a different IP address each time they log on. If this is the case with your ISP, click **Obtain an IP Address Automatically** and continue to step 5. If your ISP assigns you a fixed IP address, click **Specify an IP Address** and enter the address into the **Subnet Mask, Default Gateway Address** and **DNS** fields provided by the ISP.

PPPoE (Point-to-Point Protocol over Ethernet) Some DSL-based ISPs use PPPoE to establish communications with an end-user. If you are using a DSL line, check with your ISP to see if they use PPPoE. If they do use PPPoE, you must enable it. If you do enable PPPoE, remember to remove any existing PPPoE applications already on any of your PCs. To enable PPPoE:

1. Click on the **Enable** option in the PPPoE section of the *Setup* screen.
2. Enter the **User Name** you use to log on to your Internet connection.
3. Enter your corresponding **Password**.

Connect on Demand (Only available if PPPoE is enabled) If you aren't actively using the Internet, you can configure your Router to cut your connection with your ISP after a certain period of time. If you have been disconnected due to inactivity, *Connect on Demand* enables your Router to automatically re-establish your connection as soon as you attempt to access the Internet again. If you wish to activate *Connect on Demand*, choose the **Enable** option.

Max Idle Time (Only available if PPPoE is enabled) *Max Idle Time* is the number of minutes that passes before the Router drops your Internet connection, due to inactivity. If you want your Internet connection to remain on at all times, enter zero (0) in this field and click **Apply**. Otherwise, enter in the number of minutes you want to elapse before your Internet access disconnects.

Keep Alive Option (Only available if PPPoE is enabled) This option keeps your PPPoE-enabled Internet access connected indefinitely, even when it sits idle. It keeps the connection alive by sending out a few data packets periodically, so your Internet service thinks that the connection is still active. To use this option, click on the box next to **Keep Alive** to select it, and click **Apply**.

Net2Phone Option This option enables your Net2Phone account that came with your Router. Click **Enable** if you wish to enable your account at this time. Both the *Account Number* and *PIN* will appear on the Net2Phone/Linksys Rechargeable Calling Card that came in your Router's box. If you have difficulty, click on the **Help** tab to connect to Net2Phone's website (once your Internet connection is established) or call Net2Phone (refer to their contact information in the **Net2Phone Troubleshooting/Frequently Asked Questions** section).

For further instructions on setting up your account and making phone calls, refer to the **Setting Up Your Net2Phone Account** section of this User Guide.

5. When you have properly configured the *Setup* page, click **Apply**, then click **Continue**.

6. Choose the **DHCP** tab.

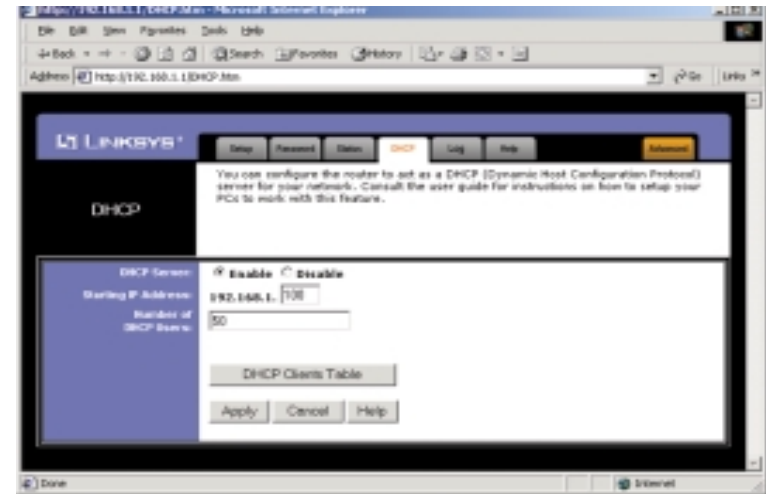

Note: You cannot have two DHCP servers running on one LAN at the same time. If you have an existing DHCP server on your LAN, you must decide which device will act as server. If you choose this Router, you must disable the DHCP capabilities of the other device, and vice versa. The device which is not the DHCP server must have a static IP address, which must be compatible with your existing network in order to be recognized.

7. Unless you already have a DHCP server on your internal network, choose **Enable** from the *DHCP Server* field. By choosing **Enable**, you will configure the Router to automatically assign IP addresses to each of your PCs. In the *Number of DHCP Users* box, enter the number of PCs you plan on networking to the Router. Don't forget to change this number if, in the future, you add more PCs to your network. In most cases, these values will not have to be changed unless you have more than 50 computers on the network.

Note: Ensure that a Network Card or adapter has been successfully installed into each PC you plan on configuring prior to continuing.

8. Click **Apply**, then click **Continue**.

9. **Reset the power on the cable or DSL modem**, then restart the computer so the computer can obtain the new Router information.

Your Cable/DSL Router is now configured to your network. If you would like, you may continue on to set up your Net2Phone Account.

Setting Up Your Net2Phone Account

Once your Router is completely installed and set up, you can activate your Net2Phone account. You will need the following before you can set up your Linksys Cable/DSL & Voice Router powered by Net2Phone to place low cost phone calls:

- Calling Card w/ Account # and PIN (included with your Net2Phone Router)
- Phone (to plug into your Net2Phone Router)
- Standard Phone cord (to connect your phone to Net2Phone Router)

Before you can use your FREE minutes, you must activate your account, following the directions below.

1. Choose the **Setup** tab.
2. If you have not already done so, enter the account # that is on the back of your calling card.
3. Enter the PIN that is on the back of your calling card
4. Click **Apply**.
5. Choose the **Help** tab. Click on **Net2Phone/My Account** button. (This will link you to the Linksys/Net2Phone Broadband web page where you can activate your Net2Phone Broadband account.)



6. Follow the instructions in order to activate your account and sign up for service.
7. Once your account is activated follow the directions below for connecting your phone to the Router.

EtherFast® Cable/DSL & Voice Router powered by Net2Phone

Connecting Your Phone to the Linksys Cable/DSL & Voice Router powered by Net2Phone

1. Plug one end of your standard telephone cable into the phone.



2. Plug the other end of the cable into Phone Port on back of Router (see picture)

Placing Phone Calls with Linksys Cable/DSL & Voice Router powered by Net2Phone

1. Pick up the receiver.
2. Dial the number and press #.

You must press # after you dial the number, or the call will not go through.

If you experience any difficulty, refer to the **Net2Phone Troubleshooting/Frequently Asked Questions** section of the manual.

*Any Net2Phone services provided through this Equipment are not intended to replace or be a substitute for primary line voice services or Plain Old Telephone Service ("POTS") and are not meant to provide guaranteed Automatic Number Identification or Automatic Location Information capabilities associated with 911 or E911 services or to permit access to 411 directory assistance services. Net2Phone will not be liable for any damages, expenses, liabilities, risks, or harms arising out of or related to the Net2Phone services provided through this Equipment.

**If you currently have a Net2Phone PC2Phone or Net2Phone Direct account number, it can not be used with this service! You must use the account number printed on the calling card that was enclosed with your Linksys Etherfast Cable/DSL & Voice Router powered by Net2Phone.

The Cable/DSL Voice Router's Web-based Utility

Quick & Easy Administration

The EtherFast Cable/DSL Voice Router has an internal integrated-circuit chip but no keyboard, monitor or mouse capabilities. Because of these limitations, an administrative utility has been programmed into that chip. All router-based administrative tasks are performed through this web utility. The web utility can be accessed by any PC on the network by typing `http://192.168.1.1` into the PC's web browser address window.



Upon entering the address into the web browser, a password request page will pop up.

Leave the User Name field empty, but type “**admin**” into the Password field.



On the following pages you will find brief descriptions of each utility web-page and each page's more important functions. More detailed explanations and instructions can be found by clicking each page's **Help** button. To apply any settings you've altered on any page, click the **Apply** button. To clear any values you've entered on any page, click **Cancel** and re-enter information before you click **Apply**. Once all settings are correct, click **Continue**.

Setup

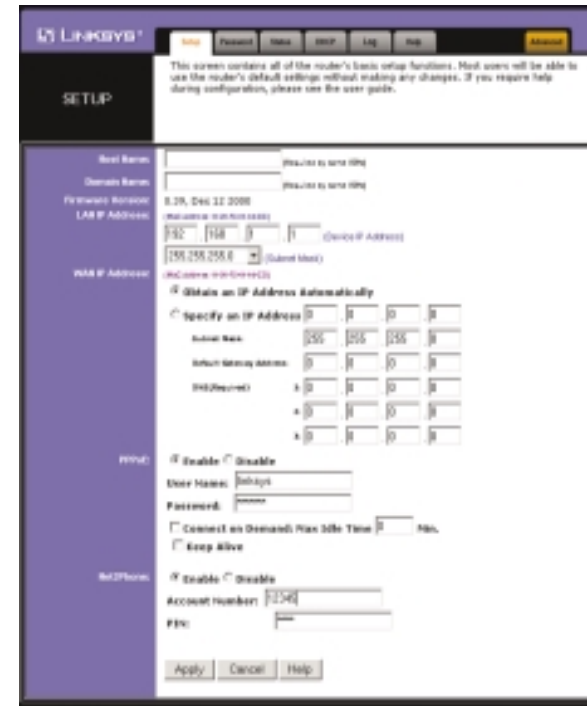

Note: The Setup page shown in this graphic may differ from the one seen on your router.

The Basic Setup screen is the first screen you will see when you access the Utility. If you have already installed and setup your router, you have already seen this screen and have already properly configured all of the screen's values.

- **Host Name** This entry is necessary for some ISPs. Ask your ISP.
- **Domain Name** This entry is necessary for some ISPs. Ask your ISP.
- **Firmware Version** This entry shows the version of the firmware you are using. Future versions of the Router's Firmware may become available on the Linksys Website.
- **LAN IP Address and Subnet Mask** The IP Address and Subnet Mask of the router as it is seen on the internal LAN. The default value is 192.168.1.1 for IP and 255.255.255.0 for Subnet Mask. Unless you already know your settings, we recommend that you keep the defaults.
- **WAN IP Address and Subnet Mask** The IP Address and Subnet Mask of the router as seen by external users on the Internet (including your ISP). If set to Obtain an IP address automatically, these values are assigned by your ISP.

- **Default Gateway Address** Your ISP will provide you with the Gateway IP Address. If set to Obtain an IP address automatically, these values are automatically assigned by your ISP.
- **DNS (Domain Name Server) IP Address** Your ISP will provide you with at least one DNS IP Address. If set to Obtain an IP address automatically, these values are automatically assigned by your ISP.

You can test and see if the above settings are correct by successfully connecting to the Internet.

- **PPPoE (Point-to-Point Protocol over Ethernet)** Some DSL-based ISPs use PPPoE to establish communications with an end-user. If you are using a DSL line, check with your ISP to see if they use PPPoE. If they do use PPPoE, you must enable it. If you do enable PPPoE, remember to remove any existing PPPoE applications already on any of your PCs. To enable PPPoE:

1. Click on the **Enable** option in the PPPoE section of the *Setup* screen.
2. Enter the **User Name** you use to log on to your Internet connection.
3. Enter your corresponding **Password**.

- **Connect on Demand** (*Only available if PPPoE is enabled*) If you aren't actively using the Internet, you can configure your Router to cut your connection with your ISP after a certain period of time. If you have been disconnected due to inactivity, *Connect on Demand* enables your Router to automatically re-establish your connection as soon as you attempt to access the Internet again. If you wish to activate *Connect on Demand*, choose the **Enable** option.
- **Max Idle Time** (*Only available if PPPoE is enabled*) The Max Idle Time is the amount of time you would like to pass before the Router drops your Internet connection due to inactivity. If you want your Internet connection to remain on at all times, enter zero (0) in this field.
- **Keep Alive Option** (*Only available if PPPoE is enabled*) This option keeps your PPPoE-enabled Internet access connected indefinitely, even when it sits idle. It keeps the connection alive by sending out a few data packets periodically, so your Internet service thinks that the connection is still active. To use this option, click on the box next to Keep Alive to select it, and click **Apply**.

- **Net2Phone Option** This option enables your Net2Phone account that came with your Router. Click **Enable** if you wish to enable your account at this time. Both the *Account Number* and *PIN* will appear on the Net2Phone/Linksys Rechargeable Calling Card that came in your Router's box. If you have difficulty, click on the **Help** tab to connect to Net2Phone's website (once your Internet connection is established).

Password

It is strongly recommended that you set a password for the router. When you first power up the router, you will notice that the Password setting default is "admin". For security, we recommend that you change your password often.

SNMP Community allows a name to be assigned to any SNMP communities that have been setup in the network. Four different communities can be defined, including the two default communities - public and private. For each **SMNP Community** name, you can configure each community's accessibility, making it either **Read-Only** or **Read-Write**.



If you set the Restore Factory Default option and click Apply, you will clear all of the router's settings. Do not restore to the factory defaults unless you are having difficulties with the Router. Once the Router is reset, you will have to re-enter your configuration.

Status

This tab displays the current status of the Router; it reflects the data and selections you've entered under the Setup tab.

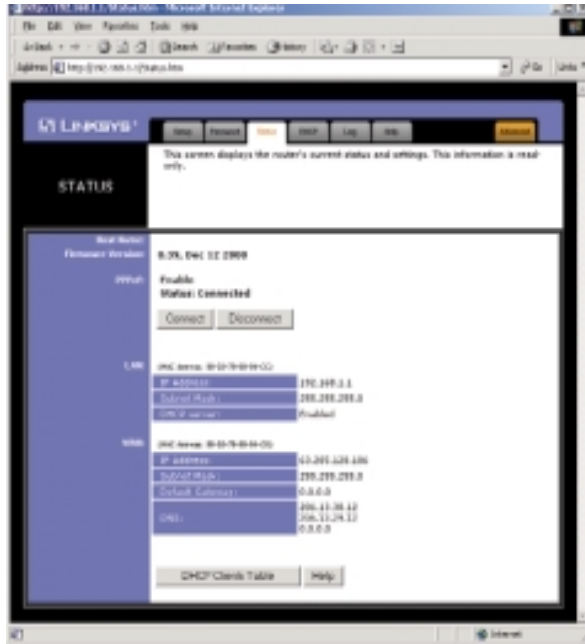

All of the information provided on this screen is read-only. To make changes, select the Setup tab.

- **Host Name** This field shows the name of your Router. This entry is necessary for some ISPs.
- **Firmware Version** This field shows the installed version and date of the firmware. Version dates are slightly more accurate than version numbers.
- **PPPoE (Point-to-Point Protocol over Ethernet)** This field shows whether you have enabled the use of the Router's PPPoE support.
- **LAN** These fields display the current IP Address and Subnet Mask of the Router, as seen by users on your internal network.
- **DHCP Server** This field shows the status of the Router's DHCP server function, which is either enabled or disabled.
- **WAN** These fields display the WAN IP Address, WAN Subnet Mask and WAN Default Gateway IP address of the Router, as seen by external users on the Internet.
- **DNS (Domain Name System) IP Address** These fields show the IP Address(es) of the DNS currently used by the Router. Multiple DNS IP settings are common. In most cases, the first available DNS entry is used.

DHCP

A DHCP (Dynamic Host Configuration Protocol) Server automatically assigns IP addresses to each computer on your network. Unless you already have one, it is highly recommended that your router be set up as a DHCP server.

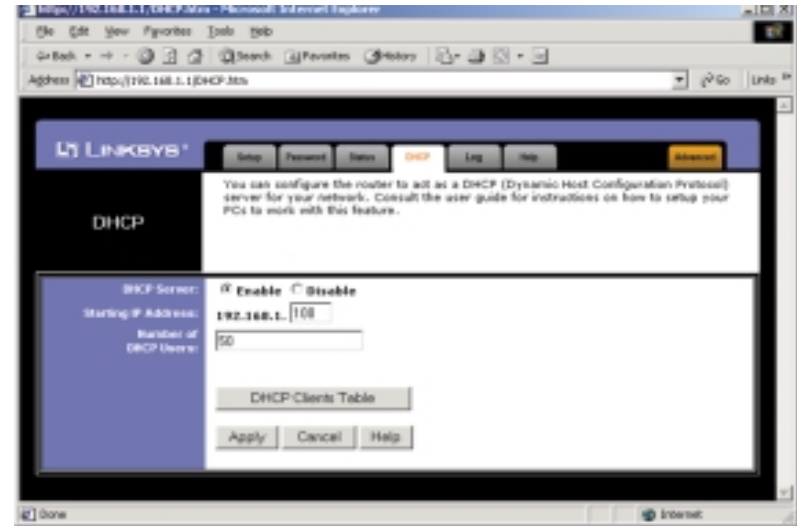

- **DHCP Server** Check the **Enable** option to enable the DHCP server option of the router. If you already have a DHCP server on your network, set the router's DHCP option to **Disable**.
- **Starting IP Address** Enter a numerical value for the DHCP server to start with when issuing IP addresses.
- **Number of DHCP users** Enter the maximum number of PCs that you want the DHCP server to assign IP addresses to, with the absolute maximum being 253.
- **DHCP Clients Table** Click on the **Clients Table** button to show the current DHCP Client information. (This information is stored in temporary memory, so the list of clients could disappear.)

Log

This tab shows the status of Logging on the Router. If you enable logging, the Router will keep a record of all packets both sent and received over the network and send it to the address specified.

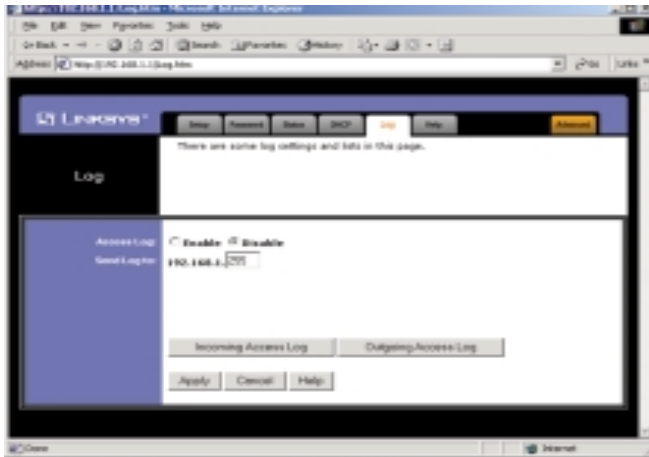

- **Access Log:** Here you will either Enable or Disable the logging feature.
- **Send Log To:** Here you will specify the address that you would like the log to be sent to.
- **Incoming/Ongoing Access Log:** Here you will specify whether you want to record incoming or outgoing packets on the network. Both can be recorded and sent to separate addresses.

To view these logs, you need the **Log Viewer** software. You can download the software from www.linksys.com.

Help

Here you will find links to all of the Utility's internal support documentation, a link to Linksys's website, the application that upgrades the Router's firmware, as well as a link to Net2Phone's website for Net2Phone account management.

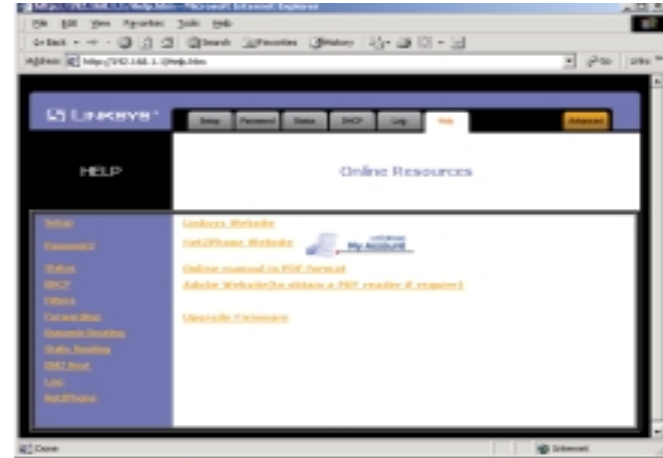

To upgrade the Router's firmware:

1. Download the latest firmware version from the Linksys website (www.linksys.com).
2. Go to the **Help** screen (above).

- Click **Upgrade Firmware**. A new page will appear.

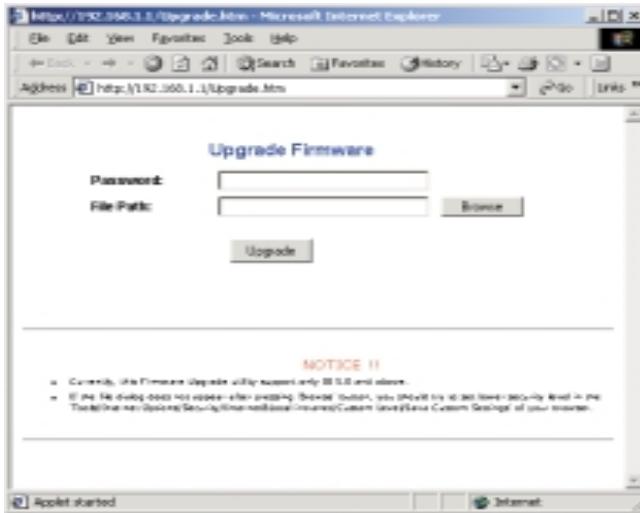

- Enter your Router's administration password into the *Password Confirm* box.
- Click the **Browse** button and find the firmware upgrade file that you downloaded from the Linksys website. Double-click the **upgrade file**. This will place the file into the "File Path:" box.
- When the correct file is in the "File Path:" box, click the **Upgrade** button and follow the instructions there. This will complete your firmware upgrade.

For information on setting up your Net2Phone Account and how to make phone calls using your account, refer to the **Net2Phone** section.

Filters

Filters block specific internal users from accessing the Internet. You can set up a filter through an IP address or a network Port number.

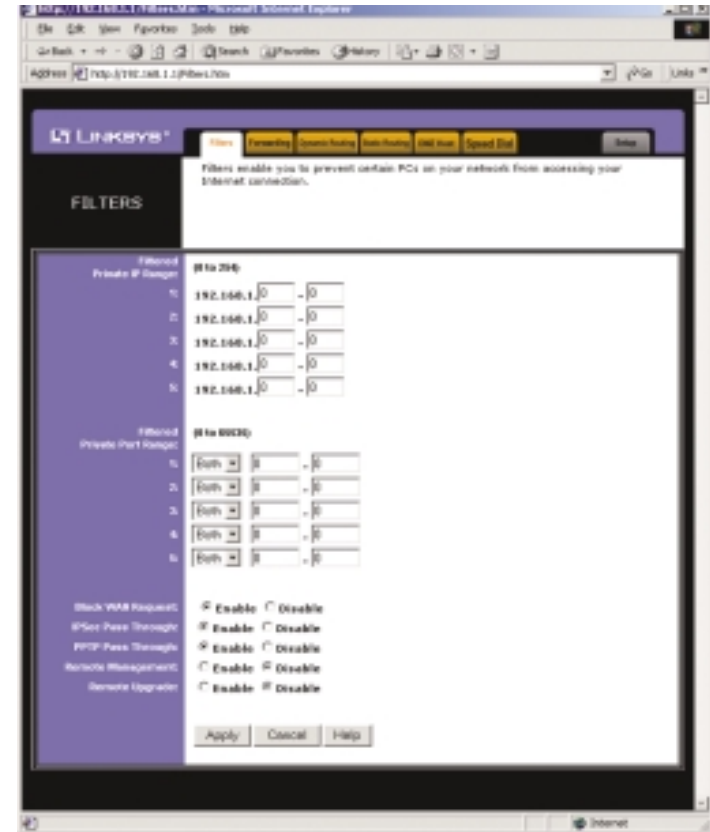

To Modify Filter Settings

- Enter the IP addresses you wish to filter into the IP address fields. The users who have these IP addresses will not be able to access the Internet.
- You can also filter users by entering their network port number and protocol (UDP, TCP or both). Enter the port numbers and protocol you want to filter into the port numbers fields. Users who are connected to the Router will no longer be able to access any port number listed there.

Block WAN Request

- By enabling the *Block WAN Request* feature, you can prevent your network from being pinged, or detected, by other Internet users. The *Block WAN Request* feature also adds another measure of security to your network by hiding your network ports. Both functions of the *Block WAN Request* feature make it more difficult for outside users to work their way into your network.

Click the **Apply** button to save any changes.

Using IPsec Pass Through

- This feature lets you use IPsec Pass Through. To use this feature, click on **Enable** next to “IPsec Pass Through,” then click on **Apply**.
- To disable IPsec Pass Through, click on **Disable** and then click on **Apply**.

Using PPTP Pass Through

- Point-to-Point Tunneling Protocol is the method used to enable VPN (Virtual Private Networking) sessions. To enable this feature, click on **Enable** next to PPTP Pass Through, and then click **Apply**.
- To disable this feature, click on **Disable** next to PPTP Pass Through, and then click **Apply**.

Using Remote Management

- This feature allows you to manage your Router from a remote location, via the Internet. To enable this feature, click on **Enable**, then click on **Apply**.
- To disable Remote Management, click on **Disable**, then click on **Apply**.

Using Remote Upgrade

- This feature allows you to “flash,” or upgrade, your Router’s firmware from a remote location. To enable Remote Upgrade, click on **Enable**, then click on **Apply**.
- To disable this feature, click on **Disable**, then click on **Apply**.

Forwarding

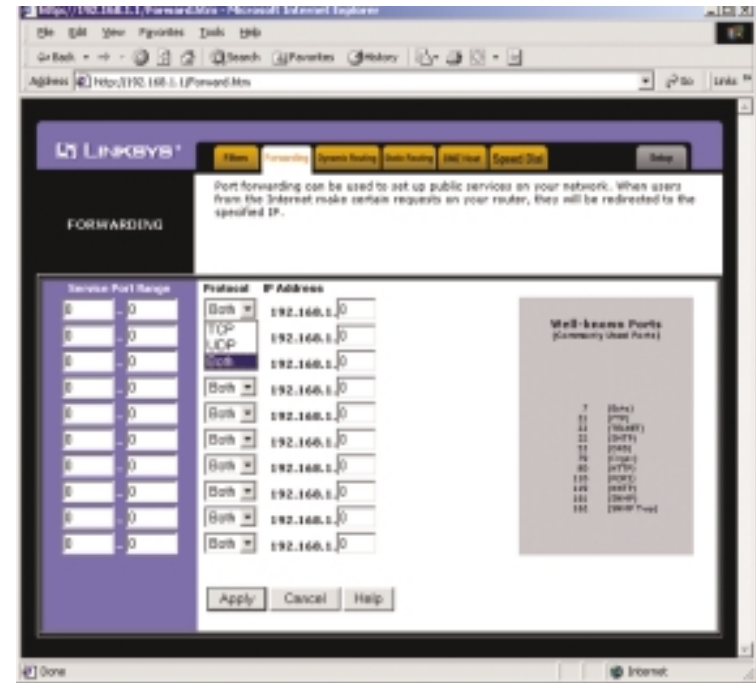

Port forwarding sets up public services on your network. When users from the Internet make certain requests of your network, the router will forward those requests to the appropriate computer. The router's DHCP function must be disabled to use Forwarding.

Forwarding is generally used to set up a web server, ftp server, or e-mail server on your network. To add a server using Forwarding:

- Enter the port number or range used by the server. On the same line, select TCP, UDP or Both. Enter the IP Address of the server that you want the Internet users to be able to access.
- Configure as many entries as you would like until all of the link entries are filled.
- Click **Apply** to save the settings.

Dynamic Routing

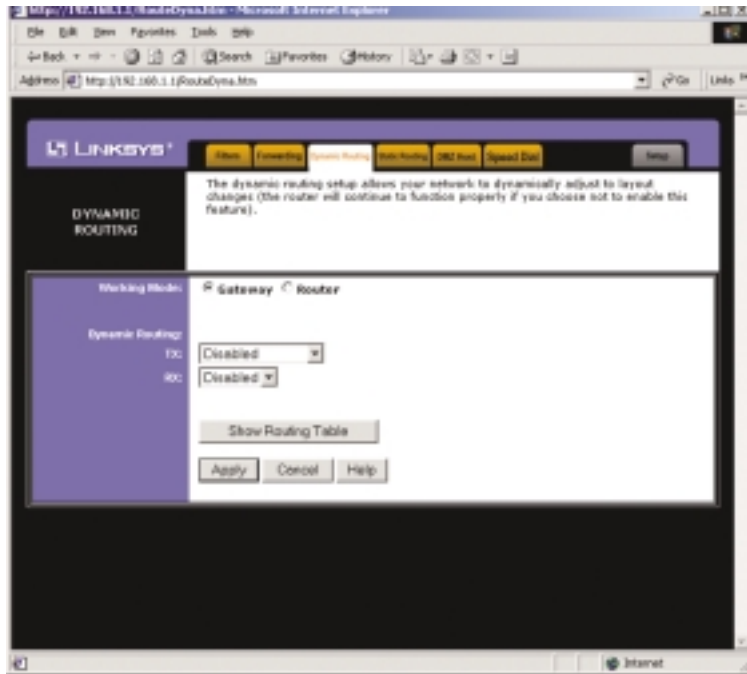

With Dynamic Routing you can automatically adjust to physical changes in the network's layout. The router, using the RIP protocol, determines the network packets' route based on the fewest number of hops between the source and the destination. The RIP protocol regularly broadcasts routing information to other routers on the network. To set up Dynamic Routing:

1. Choose the correct working mode. **Gateway Mode** should be used if your Linksys router is hosting your network's connection to the Internet. **Router Mode** should be selected if the router exists on a network with other routers.
2. In the **TX** field, choose the **protocol** by which you transmit data on the network.
3. In the **RX** field, choose the protocol by which the Router receives network data.
4. Click the **Apply** button to save your changes.

Static Routing

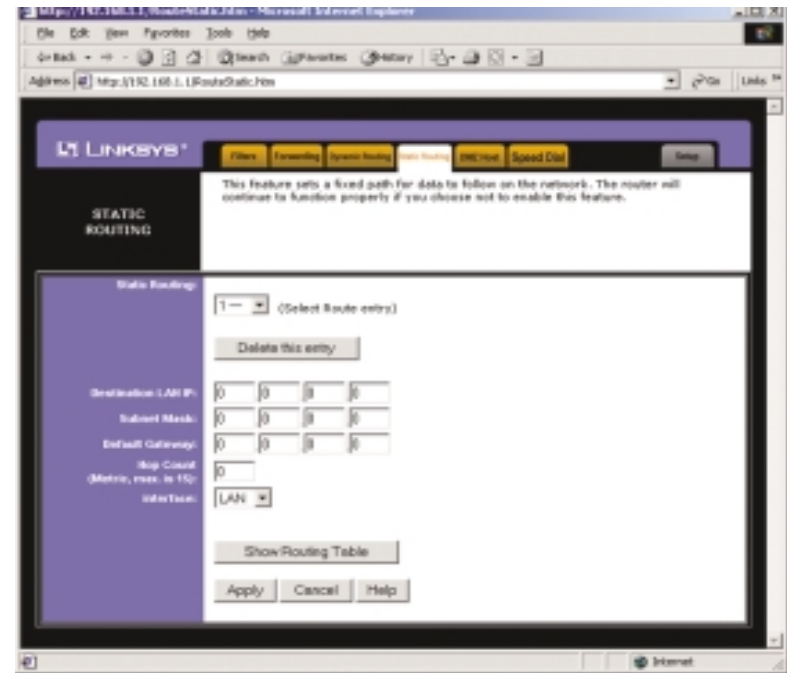

If your Router is connected to more than one network, it may be necessary to set up a static route between them. A static route is a pre-determined pathway that network information must travel to reach a specific host or network. Click the **Show Routing Table** button to view the current static routing configuration.

To create a static route entry:

1. Select **Static Route Entry** from the drop down list. The Cable/DSL Router supports up to 20 static route entries.
2. Enter the following data to create a new static route:

Destination LAN IP The Destination LAN IP is the Address of the remote network or host to which you want to assign a static route. Enter the IP address of the host for which you wish to create a static route here. If you are building a route to an entire network, be sure that the network portion

of the IP address is set to zero (0). For example, the Router's standard IP address is 192.168.1.1. Based on this address, the address of the network to which the Router is connected is 192.168.1, with the last digit (1, in this case) determining the Router's place on the network. Therefore you would enter the IP address 192.168.1.0 if you wanted to route to the Router's entire network, rather than just to the Router.

Network Mask The Network Mask (also known as the Subnet Mask) determines which portion of an IP address is the network portion, and which portion is the host portion. In the example above the Network Mask is 255.255.255.0. This determines (by using the values 255) that the first three numbers of a network IP address identify this particular network, while the last digit (from 1 to 254) would identify the specific host.

Gateway IP This IP address should be the IP address of the gateway device that allows for contact between the Router and the remote network or host.

Hop Count This value gives the number of **nodes** that a data packet passes through before reaching its destination. A node is any device on the network, such as switches, PCs, etc.

Interface This interface tells you whether your network is on the internal LAN or the WAN, or the external Internet. If you're connecting to a sub-network, select LAN. If you're connecting to another network through the Internet, select WAN.

3. Click the **Apply** button to save your changes.

DMZ Host

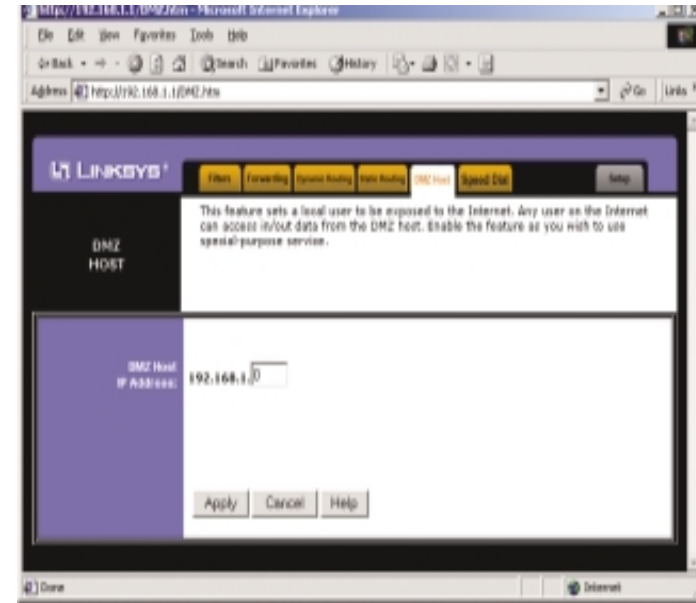

The DMZ Host setting allows one local computer to be exposed to the Internet to use a special-purpose service such as Internet gaming or video-conferencing.

To expose one computer, enter the computer's IP address and click the **Apply** button. Inactivate DMZ by entering a zero (0).

Speed Dial

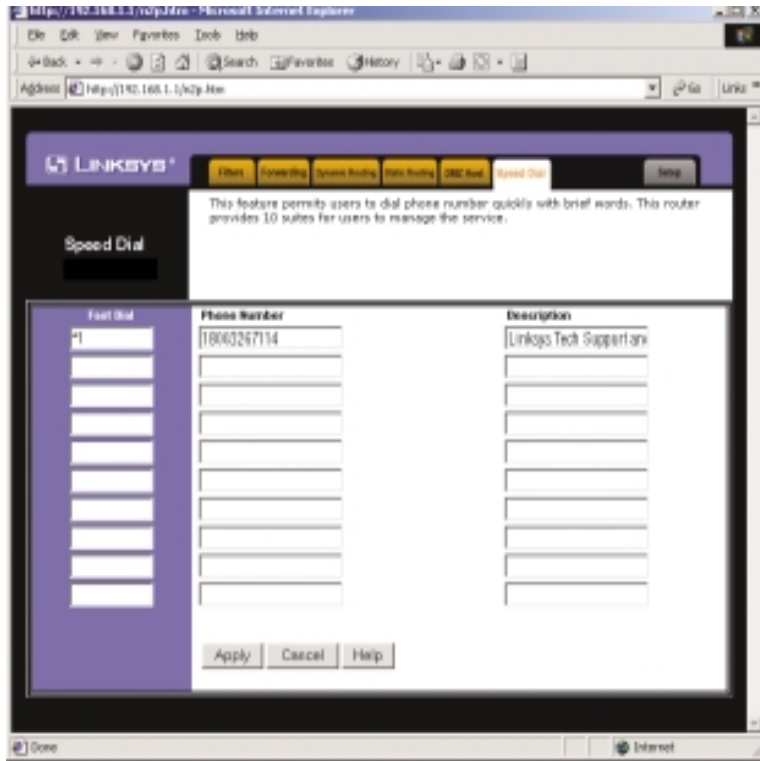

The Speed Dial setting allows users to program phone numbers that can be dialed quickly using “shortcut” type words. Ten different numbers can be input for speed dial through the voice router.

To program the “Fast Dial” option:

1. Enter the shortcut for the first telephone number you wish to program into the first available “Fast Dial” box.
2. Enter the telephone number associated with that shortcut in the corresponding phone number box.
3. Enter a description for the number in the “Description” box.
4. When calling, pick up the receiver and dial the shortcut of the telephone number you wish to call. For example, the shortcut shown above would be “*1”.

Troubleshooting

Common Problems and Solutions

This section provides possible solutions to problems regarding the installation and operation of the Cable/DSL Voice Router. Read below description to solve your problems. If you can't find an answer here, check the Linksys website at www.linksys.com.

1. I Can't connect to the Cable/DSL Router.

- The Cable/DSL Voice Router is properly installed, LAN connections are OK, and it is powered ON.
- Ensure that your PC and the Cable/DSL Voice Router are on the same network segment. If you are not sure, initiate the DHCP function, let the PC get the IP address automatically.
- Ensure that your PC is using an IP Address within the default range of 192.168.1.2 to 192.168.1.254 and thus compatible with the Cable/DSL Voice Router default IP Address of 192.168.1.1
- Also, the Subnet Mask should be set to 255.255.255.0 to match the Cable/DSL Router. In the Cable/DSL Voice Router, you can check these settings by using Control Panel-Network to check the Properties for the TCP/IP protocol.

2. The Diag LED stays lit when it shouldn't.

- The Diag LED lights up when the device is first powered up. Meantime, the system will boot up itself and check for proper operation. After finishing the checking procedure, the LED turns off to show the system is working fine. If the LED remains lit after this time, the device is not working properly. Try to re-flash the firmware by assigning a static IP address to the computer, then upgrade the firmware again. If that doesn't help, contact your dealer for further inspection.

3. I can't browse through the Cable/DSL & Voice Router.

- Check if both ends of the network cable and power adapter are properly connected. Check if the status LEDs on the front panel are functioning properly.
- If using Windows 95 or Windows 98, check the TCP/IP setup on the client side. Run "**winipcfg**" by clicking on the **Start** button, then selecting **Run**. The PC should have an IP address of 192.168.1.xxx ("xxx" is from 2 to 254.) Subnet Mask is 255.255.255.0, the default gateway IP

should be the Router's IP Address, and DNS (in "More".)

- Same as above, check the same setup values in the Status Monitor page of the Cable/DSL Router.

4. When I enter a URL or IP address, I get a time out error.

- Check if other PCs work. If they do, ensure that your workstations IP settings are correct (IP address, Subnet Mask, Default gateway and DNS)
- If the PCs are configured correctly, but still not working, check the Cable/DSL & Voice Router. Ensure that it is connected and ON. Connect to it and check its settings. (If you cannot connect to it, check the LAN and power connections.)
- If the Cable/DSL Router is configured correctly, check your Internet connection. (DSL/Cable modem etc.) to see that it is working correctly.
- Manually configure the TCP/IP with a DNS address provided by your ISP.

5. I can't obtain an IP address from my cable or DSL modem.

- Ensure that all of your cabling is properly connected and that all of the router's WAN and LAN LEDs are correctly illuminated.
- Power down your cable or DSL modem for a few seconds. Turn it back on. After the modem goes through its self-test, check to see if you now have an IP address.
- Ensure that your cable or DSL modem is DHCP-capable.
- You may have to enter the router or host name in the Setup page of the Router's web-based utility. Go to page 19 for more information.
- Your ISP may require Mac Addresses. Check with your ISP. This address can be obtained in the Status screen of the Router's Web-based Utility.

Frequently Asked Questions

What is the maximum number of IP addresses that the Cable/DSL Voice Router will support? The Router will support up to 253 IP addresses.

Is IPsec Pass-Thru supported by the Router? Yes, it is a built-in feature that the router automatically enables.

Where is the Cable/DSL Voice Router installed on the network? In a typical environment, the Router is installed between the Cable/DSL Modem and the LAN. Plug the Cable/DSL Voice Router into the Cable/DSL Modem's Ethernet port.

Does the Cable/DSL Voice Router support IPX or AppleTalk? No. TCP/IP is the only protocol standard for the Internet and has become the global standard for communications. IPX, a NetWare communications protocol used only to route messages from one node to another, and AppleTalk, a communications protocol used on Apple and Macintosh networks, can be used from LAN to LAN connections, but those protocols cannot connect from WAN to LAN.

Does the WAN connection of the Cable/DSL Voice Router support 100Mb Ethernet? Because of the speed limitations of broadband Internet connections, the Cable/DSL Router's current hardware design supports 10Mb Ethernet on its WAN port. It does, of course, support 100Mbps over in the auto-sensing Fast Ethernet 10/100 switch on the LAN side of the router.

What is Network Address Translation and what is it used for? Network Address Translation (NAT) translates multiple IP addresses on the private LAN to one public address that is sent out to the Internet. This adds a level of security since the address of a PC connected to the private LAN is never transmitted on the Internet. Furthermore, NAT allows the Cable/DSL Router to be used with low cost Internet accounts, such as DSL or cable modems, where only one TCP/IP address is provided by the ISP. The user may have many private addresses behind this single address provided by the ISP.

Does the Cable/DSL Voice Router support any operating system other than Windows 95, Windows 98, Windows 2000, or Windows NT? Yes, but Linksys does not, at this time, provide technical support for setup, configuration or troubleshooting of any non-Windows operating systems.

Does the Cable/DSL router support ICQ send file? Yes, with the following fix: ICQ menu-> preference -> connections tab-> check "I am behind a firewall or proxy", and set the firewall time-out to 80 seconds in firewall setting. The Internet user can then send a file to a user behind the router.

How do I get Napster to work with the Router? Napster is fully compatible with the Router, but you must make sure that, during installation, you select "no idea" when asked about your firewall selection. Set your proxy settings to "No Proxy Server" in your *File>Preferences*.

I setup an Unreal Tournament Server, but others on the LAN cannot join. What do I need to do? If you have a dedicated Unreal Tournament server running, you need to create a static IP for each of the LAN computers and forward

ports 7777, 7778, 7779, 7780, 7781, and 27900 to the IP address of the server. If you want to use the UT Server Admin, forward another port (8080 usually works well), then in the [UWeb.WebServer] section of the server.ini file, set the ListenPort to 8080 (to match the mapped port above) and ServerName to the IP assigned to the router from your ISP.

Can multiple gamers on the LAN get on one game server and play simultaneously with just one public IP address? It depends on the which network game or what kind of game server you are using. For example, Unreal Tournament supports multi-login with one public IP.

How do I get *Half-Life: Team Fortress* to Work with the Router? The default client port for Half-Life is 27005. The computers on your LAN need to have "+clientport 2700x" to the HL shortcut command line; the x would be 6, 7, 8, and on up. This lets multiple computers connect to the same server. *One problem:* version 1.0.1.6 won't let multiple computers with the same CD key connect at the same time, even if on the same LAN (not a problem with 1.0.1.3). As far as hosting games, the HL server does not need to be in the DMZ. Just forward port 27015 to the local IP of the server computer. There remains, however, a problem with people being booted after a few minutes with an "illegible server message."

Web page hangs, corrupt downloads, or nothing but junk characters are being displayed on the screen. What do I need to do? Force your NIC to 10Mbps or half duplex mode, and turn off the "Autonegotiate" feature of your NIC as a temporary measure. (Please look at the Network Control Panel, in your Ethernet Adapter's Advanced Properties tab.). Make sure that your proxy setting is disabled in the browser. Check our website at www.linksys.com for more information.

If all else fails in the installation, what can I do? Reset the router by holding down the reset button for at least three seconds and reset your cable or DSL modem by powering the unit off and then on. Obtain and flash the latest firmware release that is readily available on Linksys website, www.linksys.com.

How will I be notified of new router firmware upgrades? All Linksys firmware upgrades are posted on the Linksys website at www.linksys.com, where they can be downloaded for free. The router's firmware can be upgraded with TFTP programs.

Does the Cable/DSL Voice Router support IPsec? Yes, but only pass through IPsec is supported.

Will the router function in a Macintosh environment? Yes, but the router's setup pages are accessible only through Internet Explorer v4.0 or Netscape Navigator v4.0 or higher for Macintosh.

With which type of firewall is the router equipped? The Cable/DSL router uses NAT and TCP/IP port inspections.

Does the Router do Stateful packet inspection? No

I am not able to get the web configuration screen for the router. What can I do? You may have to remove the proxy settings on your Internet browser, e.g., Netscape Navigator or Internet Explorer. Or remove the dial-up settings on your browser. Check with your browser documentation.

What is DMZ? Demilitarized Zone (DMZ) allows one IP Address (computer) to be exposed to the Internet. Some applications require multiple TCP/IP ports to be open. It is recommended that you set your computer with a static IP if you want to use DMZ.

If DMZ is used, does the exposed user share the public IP with the Router? No.

Does the Router pass PPTP packets or actively route PPTP sessions? The router allows PPTP packets to pass through.

Is the Router cross-platform compatible? Any platform that supports Ethernet and TCP/IP is compatible with the router.

Will the Router allow me to use my own public IPs and Domain, or do I have to use the IPs provided by the router? The router mode allows for customization of your public IPs and Domain.

How many ports can be simultaneously forwarded? Theoretically, the router can establish 520 sessions at the same time, but you can only forward 10 ranges of ports.

Does the Router replace a modem? Is there a cable or DSL modem in the router? No, this version of the router must work in conjunction with a cable or DSL modem.

Net2Phone Frequently Asked Questions

Which modems are compatible with the router? The router is compatible with virtually any cable or DSL modem that supports Ethernet.

What are the advanced features of the router? The router's advanced features include Filters, Forwarding, Dynamic Routing, Static Routing, and DMZ host.

Does Linksys provide syslog support? No, Linksys does not currently provide syslog support.

How can I check whether I have static DHCP IP Addresses? Consult your ISP to confirm the information.

How do I get mIRC to work with the Router? Set port forwarding to 113 for the computer on which you are using mIRC. If you are experiencing difficulty after setting the port forwarding, try changing the Direct Client-to-Client (DCC) settings to a range from 1024 to 1030 on the DCC option and Forwarding page of the Web-based Setup Utility.

Why do I get interference on the line? Check to see if you have connected the standard telephone cable from the back of the Router to the wall plate. (See figure below.) The RJ-11 jack on the back of the Router is **only** made for a standard analog telephone.

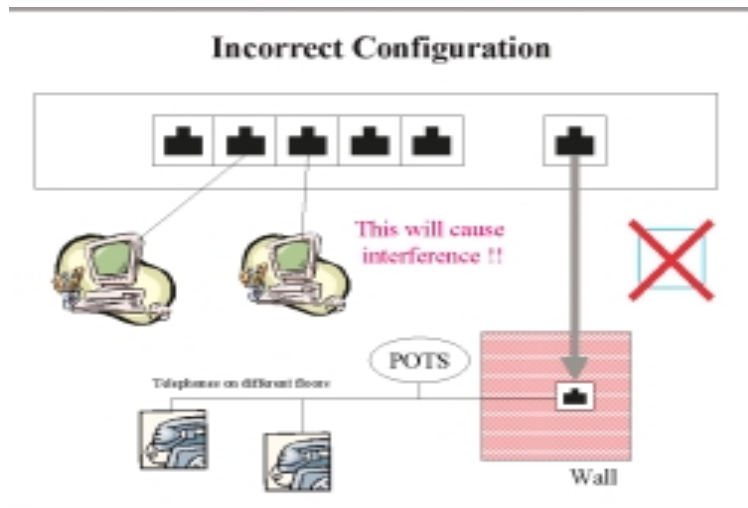

If your questions are not addressed here, refer to the contact information on the last page of this manual.

Can I set-up my Linksys Cable/DSL & Voice Router powered by Net2Phone to make calls without setting it up and configuring it for my network? No, you must set up and configure your Router on your network first.

Do these phone calls work behind NAT (Network Address Translation)? Yes

Why do my calls cost more when I use my calling card versus making calls with my Linksys Cable/DSL & Voice Router powered by Net2Phone? Because the calling card calls actually do cost more because they are originating from a regular POTS (Plain Old Telephone Service) line. Your calls that are made from the Router cost less because they are originating over the Internet.

I already have a Net2Phone account number, can I use it in place the account number printed on my calling card, which was packaged with my Router? No. The Net2Phone account number that you are already using is for a different type of service and your Router will not work with that account number. You must use the account number that is pre printed on the back of your calling card.

Why would I want to use the Linksys Cable/DSL & Voice Router powered by Net2Phone to make calls instead of using regular Net2Phone service? Because this service lets you make calls over the Internet with the ease of just picking up your phone. Also, these calls do not rely on using your computer. In fact, if you used a cordless phone with device, you could make Internet calls from any room in your house!

Can I use the Linksys Cable/DSL & Voice Router powered by Net2Phone to replace my primary phone line? No. Any Net2Phone services provided through this Equipment are not intended to replace or be a substitute for primary line voice services or Plain Old Telephone Service ("POTS") and are not meant to provide guaranteed Automatic Number Identification or Automatic Location Information capabilities associated with 911 or E911 services or to permit access to 411 directory assistance services. Net2Phone will not be liable for any damages, expenses, liabilities, risks, or harms arising out of or related to the Net2Phone services provided through this Equipment.

Net2Phone Troubleshooting Guide

What happens when I don't hear the dial-tone? There are chances that the WAV files have been corrupted. Either upgrade the firmware (see page 25) or, if you have already upgraded, reapply your firmware upgrade.

What should I do when the calls are getting dropped after a few minutes? Call Net2phone Customer Service/Network Operations Center to trace the call.

Why can't I call people using just Net2Phone or YAP software on their PCs? The Router uses different methods of identifying phone numbers and IP addresses than the Net2Phone software only calling solution. The same goes for YAP software users.

What happens when calls get connected but only one person (caller or receiver) is able to hear? This could be your Cable/DSL provider's firewall problem or it could be Net2phone's firewall problem. Contact Net2phone's NOC for further assistance.

What should I do if I get a "Connection Error"? First, check if the device is connected properly to the LAN. After that, check your Account ID and PIN to make sure that they are entered correctly.

Net2Phone Contact Information

For help with the installation or operation of this product, contact Net2Phone Customer Support at one of the phone numbers or Internet addresses below.

Information	973-412-2800
Customer Support	201-968-3202
Email	support@net2phone.com
Web	http://www.net2phone.com

If your issue is not addressed here, please read through the Linksys Troubleshooting/Frequently Asked Questions section.

Appendix

How to Ping Your ISP's E-mail & Web Addresses

Virtually all Internet addresses are configured with words or characters (i.e., www.linksys.com, www.yahoo.com, etc.) In actuality, however, these Internet addresses are assigned to IP addresses, which are the true addresses on the Internet. For example, www.linksys.com is actually 206.135.116.3. Type it into your web browser and you will wind up at the Linksys home page every time.

IP and web addresses, however, can sometimes be long and hard to remember. Because of this, certain ISPs will shorten their server addresses to single words or codes on their users' web browser or e-mail configurations. If your ISP's E-mail and Web server addresses are configured with single words ("www", "e-mail", "home", "pop3", etc.) rather than whole Internet Addresses or IP Addresses, your Router may have problems sending or receiving mail and accessing the Internet. This happens because your Router has not been configured by your ISP to accept their abbreviated server addresses.

The solution is to determine the true web addresses behind your ISP's code words. You can determine the IP and web addresses of your ISP's servers by "pinging" them.



If you don't have your ISP's web and e-mail IP Addresses, you must either get them from your ISP or follow these steps prior to connecting your Cable/DSL Router to your network.

Step One: Pinging an IP Address

The first step to determining your ISP's web and e-mail server address is to ping its IP Address.

1. **Power on the computer and the cable or DSL modem**, and restore the network configuration set by your ISP if you have since changed it.
2. **Click Start**, then **Run**, and type "command". This will bring up the DOS Window..

3. **At the DOS command prompt**, type "ping mail" (assuming that the location for which you're trying to find an IP address is configured as "mail"). Press **Enter**. Information such as the following data, taken from a ping of Microsoft Network's e-mail server, will be displayed.

```
C:\>ping mail

Pinging mail [24.53.32.4] with 32 bytes of data:

Reply from 24.53.32.4: bytes=32 time<10ms TTL=128
Reply from 24.53.32.4: bytes=32 time<10ms TTL=128
Reply from 24.53.32.4: bytes=32 time<10ms TTL=128
Reply from 24.53.32.4: bytes=32 time<10ms TTL=128

Ping statistics for 24.53.32.4:
    Packets: Sent = 4, Received = 4, Lost = 0 (0%
    loss),
Approximate round trip times in milli-seconds:
    Minimum = 0ms, Maximum = 0ms, Average = 0ms
```

4. **Write down the IP address returned by the ping command.** (In the example above: 24.53.32.4.) This IP address is the actual IP address of the server "mail", or any other word or value you have pinged.

Step Two: Pinging for a Web Address

While the IP address returned above would work as your e-mail server address, it may not be permanent. IP Addresses change all the time. Web addresses, however, usually don't. Because of this, you're likely to have less problems by configuring your system with web addresses rather than IP addresses. Follow the instructions below to find the web address assigned to the IP address you just pinged.

1. **At the DOS command prompt**, type "ping -a 24.53.32.4", where 24.53.32.4 is the IP address you just pinged. Information such as the following data will be displayed.

```
C:\>ping -a 24.53.32.4

Pinging mail.msnv3.occa.home.com [24.53.32.4] with 32
bytes of data:

Reply from 24.53.32.4: bytes=32 time<10ms TTL=127
Reply from 24.53.32.4: bytes=32 time<10ms TTL=127
Reply from 24.53.32.4: bytes=32 time<10ms TTL=127
Reply from 24.53.32.4: bytes=32 time<10ms TTL=127

Ping statistics for 24.53.32.4:
    Packets: Sent = 4, Received = 4, Lost = 0 (0%
    loss),
Approximate round trip times in milli-seconds:
    Minimum = 0ms, Maximum = 0ms, Average = 0ms
```

2. **Write down the web address returned by the ping command.** (In the example above: mail.msnv3.occa.home.com.) This web address is the web address assigned to the IP address you just pinged. While the IP address of "mail" could conceivably change, it is likely that this web address will not.
3. **Replace your ISP's abbreviated server address** with this extended web address in the corresponding Internet application (web browser, e-mail application, etc.).

Once you have replaced the brief server address with the true server address, your Router should have no problem accessing the Internet through that Internet application.

Installing the TCP/IP Protocol

Follow these instructions to install the TCP/IP Protocol on one of your PCs *only* after a network card has been successfully installed inside the PC. These instructions are for Windows 95 and Windows 98. For TCP/IP setup under Microsoft Windows NT, please refer to your Microsoft Windows NT manual.

1. Click the **Start** button. Choose **Settings**, then **Control Panel**.
2. Double-click the **Network** icon. Your Network window should pop up. Select the **Configuration** tab.

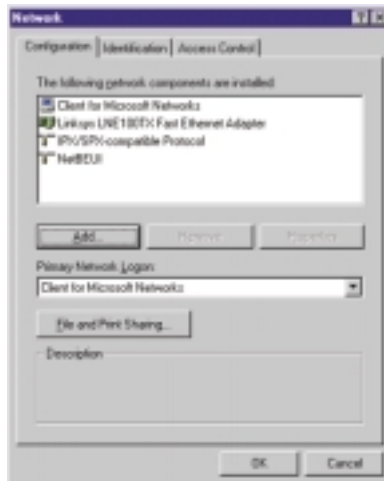

3. Click the **Add** button.
4. Double-click **Protocol**.
5. Highlight **Microsoft** under the list of manufactures.

6. Find and double-click **TCP/IP** in the list to the right (below).

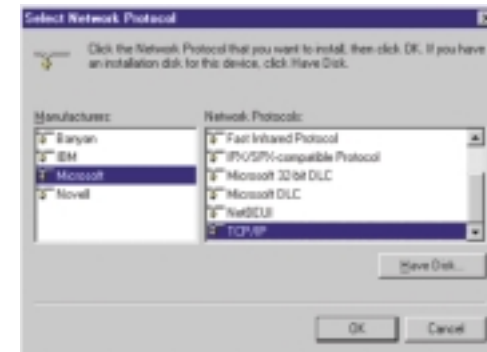

7. After a few seconds you will be brought back to the main Network window. The TCP/IP Protocol should now be listed.

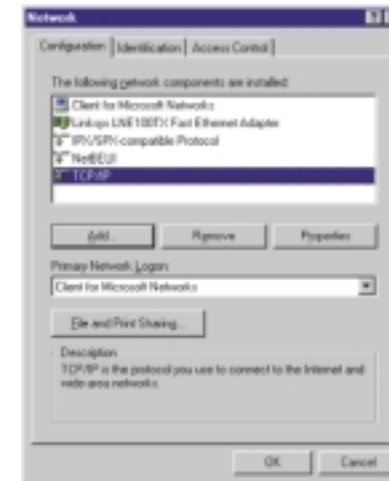

8. Click **OK**. Windows may ask for original Windows installation files. Supply them as needed (i.e.: D:\win98, D:\win95, c:\windows\options\cabs.)
9. Windows will ask you to restart the PC. Click **Yes**.

The TCP/IP Installation is complete.

Twisted-Pair Cabling

There are different grades, or categories, of twisted-pair cabling. Category 5 is the most reliable and is highly recommended. Category 3 is a good second choice. Straight-through cables are used for connecting computers to a hub. Crossover cables are used for connecting a hub to another hub (there is an exception: some hubs have a built-in uplink port that is crossed internally, which allows you to link or connect hubs together with a straight-through cable instead).

RJ-45 Color Chart

- Wire 1** → White with an Orange Stripe
- Wire 2** → Orange
- Wire 3** → White with a Green Stripe
- Wire 4** → Blue
- Wire 5** → White with a Blue Stripe
- Wire 6** → Green
- Wire 7** → White with a Brown Stripe
- Wire 8** → Brown

You can buy pre-made Category 5 cabling, or cut and crimp your own. Category 5 cables can be purchased or crimped as either straight-through or crossover. Inside a Category 5 cable are 8 thin, color-coded wires inside that run from one end of the cable to the other. All 8 wires are used. In a straight-through cable, wires 1, 2, 3, and 6 at one end of the cable are also wires 1, 2, 3, and 6 at the other end. In a crossover cable, the order of the wires change from one end to the other: wire 1 becomes 3, and 2 becomes 6.

See the diagrams on the next page for more

detailed information on straight-through and crossover cabling.

straight-through cable		crossed cable	
Wire	Becomes	Wire	Becomes
1	1	1	3
2	2	2	6
3	3	3	1
6	6	6	2

To determine which wire is wire number 1, hold the cable so that the end of the plastic RJ-45 tip (the part that goes into a wall jack first) is facing away from you. Face the clip down so that the copper side faces up (the springy clip will now be parallel to the floor). When looking down on the copper side, wire 1 will be on the far left.

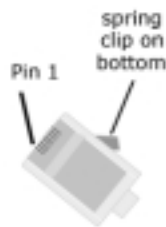

Crimping Your Own Network Cables

• Straight-Through Cabling

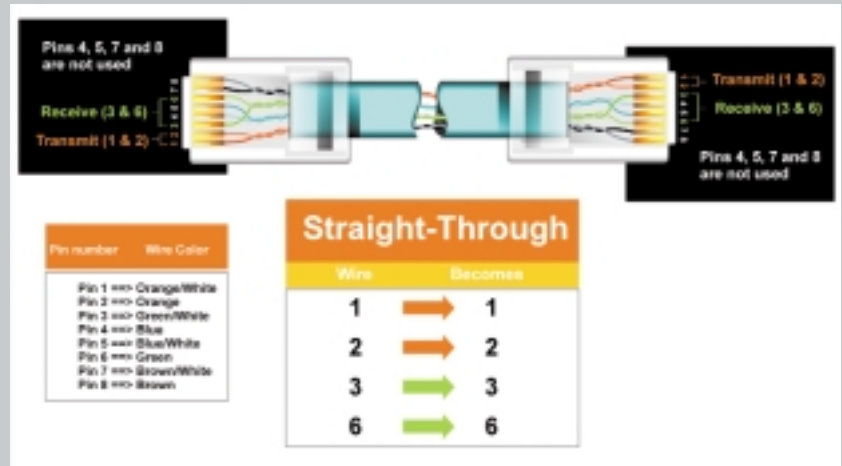

• Cross-Over Cabling

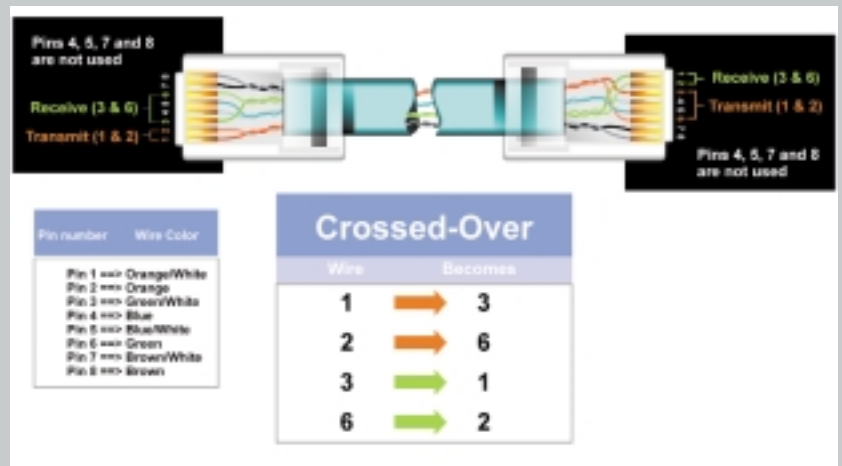

Cable/DSL Voice Router Specifications

Model Number	BEFN2PS4
Standards	IEEE 802.3, 10BaseT, 802.3u 100BaseTX
Protocol	CSMA/CD
Ports	Four 10/100 RJ45 Switched connectors (LAN) One Shared Uplink Port One RJ-11 Port One 10Base-T Ethernet RJ-45 connector for ADSL/Cable Modem (WAN)
Speed	Router - 10Mbps, Switch - 10/100Mbps (Half Duplex) 20/200 (Full Duplex)
Cabling Type	10BaseT: UTP/STP Category 3 or 5 100BaseTX: UTP/STP Category 5 Standard Telephone Cable
Topology	Star
LED Indicators	Power, Net2Phone In Use
WAN	Link/Activity, Diag for WAN
LAN	Full Duplex/Collision, Speed for LAN, Link/Activity

Environmental

Dimensions	186 x 154 x 48 mm (7.31 x 6.16 x 1.88 inches)
Unit Weight	14.2 oz.
Power Input	External, 12V AC 1A
Certifications	FCC Class B, CE Mark Commercial
Operating Temperature	0°C to 45°C (32°F to 113°F)
Storage Temperature	-20°C to 70°C (-4°F to 158°F)
Operating Humidity	0% to 85% non-condensing
Storage Humidity	5% to 90% non-condensing

Warranty Information

BE SURE TO HAVE YOUR PROOF OF PURCHASE AND A BARCODE FROM THE PRODUCT'S PACKAGING ON HAND WHEN CALLING. RETURN REQUESTS CANNOT BE PROCESSED WITHOUT PROOF OF PURCHASE.

IN NO EVENT SHALL LINKSYS' LIABILITY EXCEED THE PRICE PAID FOR THE PRODUCT FROM DIRECT, INDIRECT, SPECIAL, INCIDENTAL, OR CONSEQUENTIAL DAMAGES RESULTING FROM THE USE OF THE PRODUCT, ITS ACCOMPANYING SOFTWARE, OR ITS DOCUMENTATION. LINKSYS DOES NOT OFFER REFUNDS FOR ANY PRODUCT.

LINKSYS OFFERS CROSS SHIPMENTS, A FASTER PROCESS FOR PROCESSING AND RECEIVING YOUR REPLACEMENT. LINKSYS PAYS FOR UPS GROUND ONLY. ALL CUSTOMERS LOCATED OUTSIDE OF THE UNITED STATES OF AMERICA AND CANADA SHALL BE HELD RESPONSIBLE FOR SHIPPING AND HANDLING CHARGES. PLEASE CALL LINKSYS FOR MORE DETAILS.



Contact Information

For help with the installation or operation of this product, contact Linksys Customer Support at one of the phone numbers or Internet addresses below.

Information	800-546-5797 (LINKSYS)
Tech Support and RMA Issues	800-326-7114
Fax	949-261-8868
Email	support@linksys.com
Web	http://www.linksys.com
FTP Site	ftp.linksys.com



<http://www.linksys.com>

© Copyright 2000 Linksys, All Rights Reserved.
Printed in the USA.