

## FCC STATEMENT

This device complies with part 15 of the FCC Rules. Operation is subject to the following two conditions: (1) This device may not cause harmful interference, and (2) this device must accept any interference received, including interference that may cause undesired operation.

Warning: Changes or modifications to this unit not expressly approved by the party responsible for compliance could void the user's authority to operate the equipment.

This equipment has been tested and found to comply with the limits for a Class B digital device, pursuant to Part 15 of the FCC Rules. These limits are designed to provide reasonable protection against harmful interference in a residential installation. This equipment generates, uses and can radiate radio frequency energy, and, if not installed and used in accordance with the instructions, may cause harmful interference to radio communications. However, there is no guarantee that interference will not occur in a particular installation. If this equipment does cause harmful interference to radio or television reception, which can be determined by turning the equipment off and on, the user is encouraged to try to correct the interference by one or more of the following measures:

- Reorient or relocate the receiving antenna.
- Increase the separation between the equipment and the receiver.
- Consult the dealer or an experienced radio/TV technician for help.

Shielded cables must be used with this unit to ensure compliance with the Class B FCC limits.

If you have any questions, please contact:

Consumer Affairs  
Hasbro, Inc.  
1027 Newport Avenue,  
Pawtucket, RI  
Tel: 1-800-844-3733  
Fax: 1-401-431-8082

Product and colors may vary.  
© 2006 Hasbro. All Rights Reserved.  
TM & © denote U.S. Trademarks.

76348 PN 6581780000

**TIGER**  
ELECTRONICS™  
Where Technology Comes to Play!™



TIGERTOYS.COM

For new products and offers

Questions? Call: 1-800-327-8264

# VCAMNOW 2.0™

## Digital Video Camera

### QUICK START GUIDE

To start using your Digital Video Camera, follow these simple steps.

See the main user guide on CD for the full documentation for the VCAMNOW 2.0. It is installed on your computer as part of the installation process. To read the complete user guide, please go to Start -> Programs -> VCamNow 2.0 -> User Guide.

#### CONTENTS:

- VCAMNOW 2.0 Digital Video Camera
- Software Installation CD
- USB Cable
- AV Cable

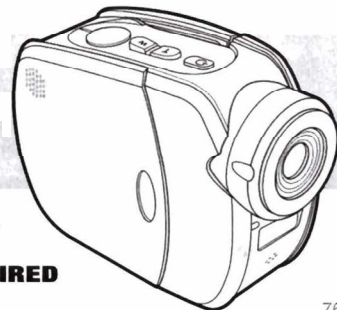

**x2**  
1.5VAA or R6 size  
NOT INCLUDED

**BATTERIES REQUIRED**

Alkaline batteries recommended.

76348

## TO INSERT BATTERIES

Open cover. Insert 2 x 1.5V "AA" or R6 size batteries (not included). Alkaline batteries recommended. Close cover.

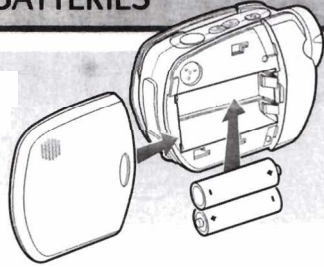

### **CAUTION: TO AVOID BATTERY LEAKAGE**

1. Be sure to insert the batteries correctly and always follow the toy and battery manufacturers' instructions;
2. Do not mix old batteries and new batteries or alkaline, standard (carbon-zinc) or rechargeable (nickel-cadmium) batteries;
3. Always remove weak or dead batteries from the product.

### **IMPORTANT: BATTERY INFORMATION**

Please retain this information for future reference.

Batteries should be replaced by an adult.

### **CAUTION:**

1. Always follow the instructions carefully. Use only batteries specified and be sure to insert item correctly by matching the + and - polarity markings.
2. Do not mix old batteries and new batteries or standard (carbon-zinc) with alkaline batteries.
3. Remove exhausted or dead batteries from the product.
4. Remove batteries if product is not to be played with for a long time.
5. Do not short-circuit the supply terminals.
6. Should this product cause, or be affected by, local electrical interference, move it away from other electrical equipment. Reset (switching off and back on again or removing and re-inserting batteries) if necessary.
7. **RECHARGEABLE BATTERIES:** Do not mix these with any other types of batteries. Always remove from the product before recharging. Recharge batteries under adult supervision. **DO NOT RECHARGE OTHER TYPES OF BATTERIES.**

# GETTING STARTED

## GETTING TO KNOW YOUR DIGITAL VIDEO CAMERA

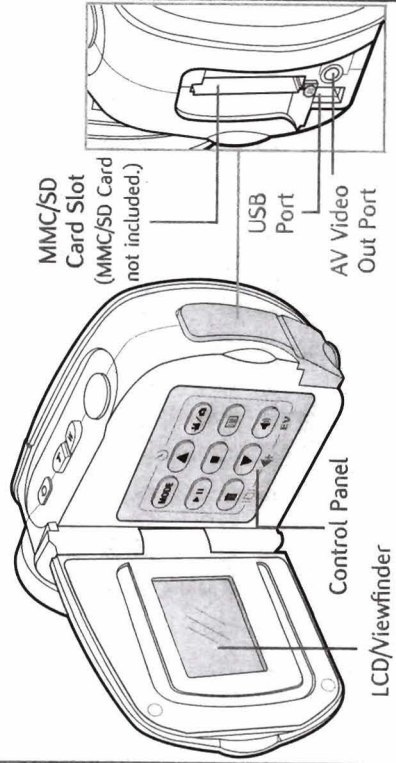
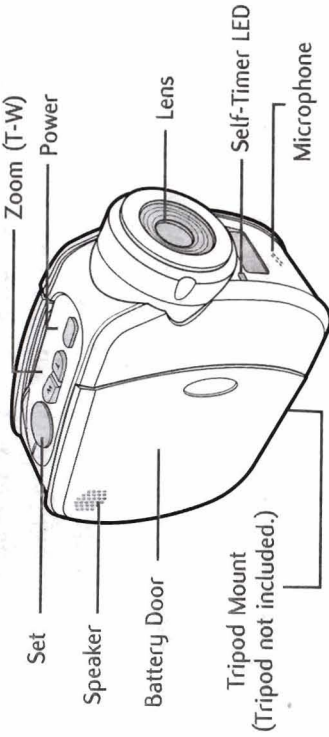

Software Installation CD

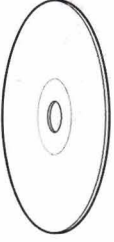

AV Cable

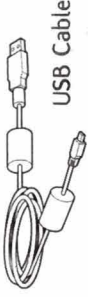

USB Cable

## CONTROL PANEL

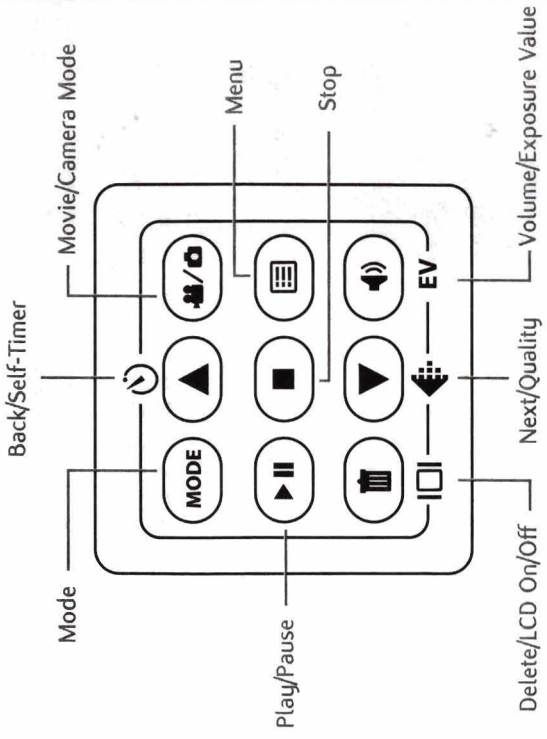

## POWER ON AND OFF

Press the Power button to turn your Digital Video Camera ON.

Press the Power button again to turn your Digital Video Camera OFF.

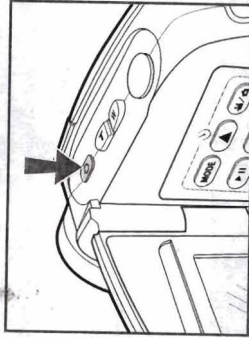

## LOW BATTERY POWER INDICATOR



If your batteries are running low, you will see a battery icon  appear on the top center of the LCD/Viewfinder.

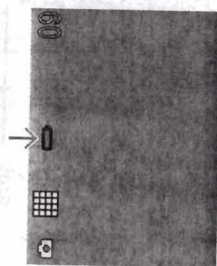

If your batteries are about to run out, you will see a blinking battery icon  appear on the top center of the LCD/Viewfinder. At this point, you'll have 10 seconds before your Digital Video Camera will automatically turn off.

## MOVIES

### HOW TO RECORD A MOVIE

1. Press the  button until you see the movie icon appear on the LCD/Viewfinder.

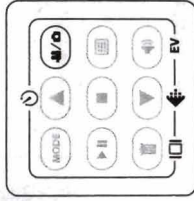

2. Press the Zoom button, T or W, to adjust the frame of your movie.

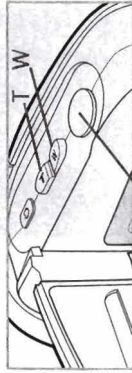

Set

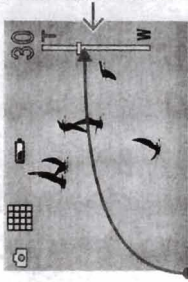

zoom in or zoom out

3. Press Set to start recording.
4. Press Set to stop recording.

NOTE: If you have an MMC/SD Card inserted (not included), your movie will be automatically stored to the MMC/SD Card, not the internal memory. If you want to record to the internal memory only, remove the MMC/SD Card.

## HOW TO PLAYBACK A MOVIE

1. Press the "Mode" button to enter playback mode.

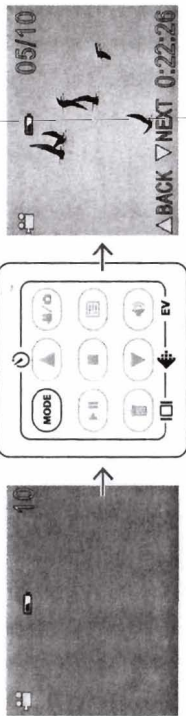

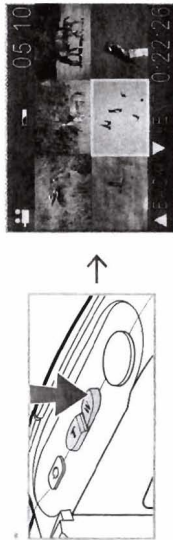

2. Press the W on the Zoom button to view multiple images of the movies on the camera.

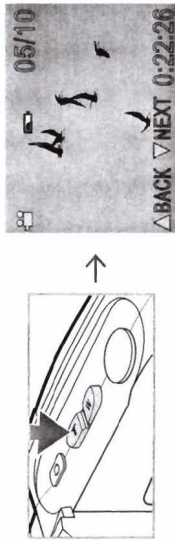

3. Press the T on the Zoom button to view a single image.



4. Use the  and  buttons to select the movie you wish to view.

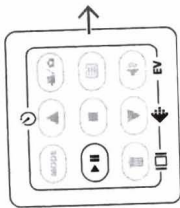
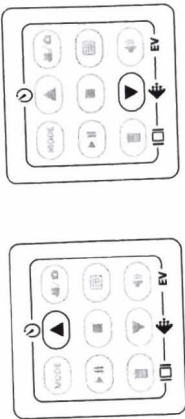

5. Press the  button to play the movie.

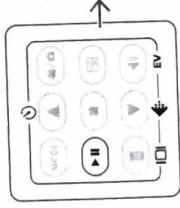

6. Press the  button to pause the movie.

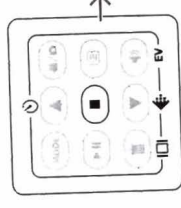

7. Press the  button to stop the movie.

NOTE: If you have an MMC/SD Card inserted (not included), your movie will be automatically stored to the MMC/SD Card, not the internal memory and will playback from this location. If you want to record and playback from the internal memory only, remove the MMC/SD Card.

## PICTURES

### HOW TO TAKE A PICTURE

1. Press the  button until you see the camera icon appear on the LCD/Viewfinder.

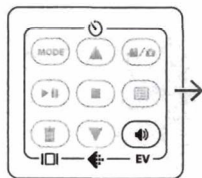

2. To set the resolution of your picture, press  to switch between 2048 x 1536, 1600 x 1200 or 640 x 480.

3. Press the Zoom button, T or W, to adjust the frame of your picture.

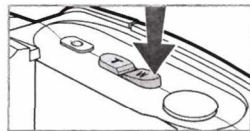
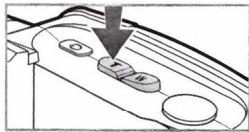

4. Press Set to take a picture.

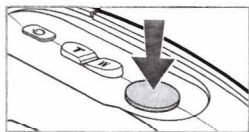

### HOW TO REVIEW A PICTURE

1. Press the "Mode" button to enter playback mode.

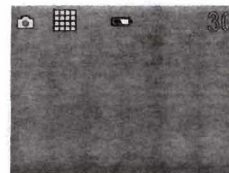
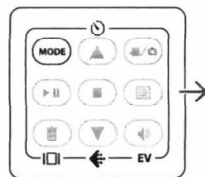

2. Press the T or W on the Zoom button to preview one picture or multiple pictures on the LCD/Viewfinder.

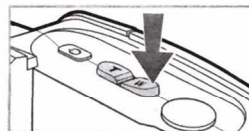
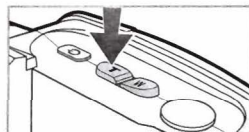

3. Press  or  to select the picture that you want to view.

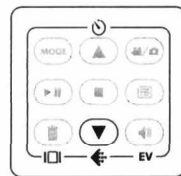
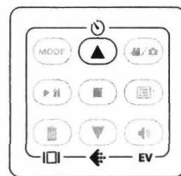

NOTE: If you have an MMC/SD Card inserted (not included), your picture will be automatically stored to the MMC/SD Card, not the internal memory and will be reviewed from this location. If you want to take pictures and review them from the internal memory only, remove the MMC/SD Card.

## DELETE ONE

This mode allows you to delete one movie or picture at a time.

1. Press the "Mode" button to enter playback mode.



2. Use the and buttons to select a specific movie or picture and then press the button. The screen will say "DELETE ONE?"

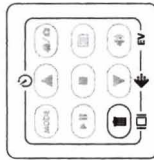
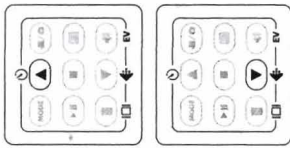

3. Press Set to confirm the deletion.

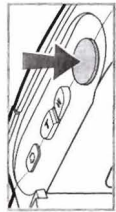

4. Press the button to keep your picture or movie and exit back to the picture or movie menu screen.

## DELETE ALL

This mode allows you to delete all of your pictures and movies at once.

1. Press the "Mode" button to enter playback mode.

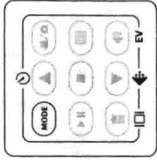

2. Press the button twice. The screen will say "DELETE ALL?"

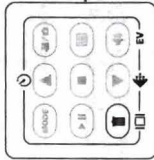

3. Press Set to confirm the deletion.



4. Press the button to keep your pictures or movies and exit back to the picture or movie menu screen.

## HOW TO INSTALL THE SOFTWARE ON YOUR COMPUTER

[PC Compatible Only]

The VCAMNOW 2.0 software will help you transfer your picture and movie files from your Digital Video Camera to your computer.

1. Place the CD into your computer's CD drive.
2. Follow the on-screen installation instructions.

If the CD does not begin automatically, double-click "My Computer" then double-click the CD icon with the name "VCAMNOW 2.0." Double-click the "Install" icon and follow the on-screen installation instructions.

Once the software has been installed, refer to the software user guide for instructions. To read the software user guide, go to Start > Programs > VCamNow 2.0 > Software User Guide.

## WEBCAM

### HOW TO USE YOUR DIGITAL VIDEO CAMERA AS A WEB CAM

Once connected to your computer, the Digital Video Camera can be used as a Web Cam displaying live, real-time action! To use your Digital Video Camera as a Web Cam, press the  button on your camera once it's connected to your computer.

May be used with Web Cam compatible software or capture live video with MaxConsole 2.0 software (included on CD).

To capture live video, launch MaxConsole 2.0, click on the Import tab, and click on Cam Capture Genie button.

## MEMORY

### MEMORY FULL



If your 32MB built-in memory and/or MMC/SD Memory Card is full, you will not be able to take any more pictures or record any more movies. The LCD/Viewfinder will display  for 2 seconds. When this happens, you can either delete some of your pictures and movies to make room for new ones, or transfer them to your computer, then go back and delete them from the memory.

### MEMORY CARD INSTALLATION

MMC/SD Memory Card not included.

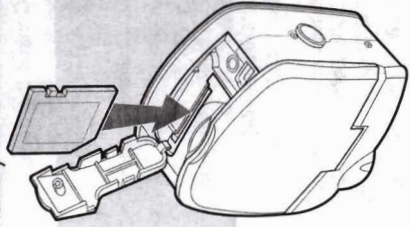

1. To install an MMC/SD Memory Card, first turn off the power.
2. Open the door.
3. Insert the MMC/SD Memory Card into the slot.
4. Close the door.





## **IMPORTANT**

**Do not copy any files into the default  
DCIM/100Media folder of this camera or**

**try to rename the files in this folder.**

**If you do, the camera may have a problem reading the memory card and in some cases the camera may not operate normally. Therefore we strongly recommend you to move your images to your hard disk before any change.**

**The equipment is to be supplied from an identified USB port complying with the requirements of Limited Power Source.**

**82-000-02010**