

R410A MULTI SPLIT SERIES ROOM AIR CONDITIONER

OUTDOOR UNIT INSTALLATION MANUAL



AU282XHERA
AU342XHERA

NO.0010577255

A

- Please read this manual carefully before installing the units.
- Please keep this manual safely for future use.

■ Contents

Cautions	1-2
Safety precautions.....	3-4
Installation accessories.....	4
Choose the installation place.....	4
Installation dimensions(mm).....	4
Installation drawings of indoor and outdoor units.....	5
Matching of the indoor and outdoor units	6-7
Power source.....	8
Limitations on the installation	8-9
Refrigerant piping work.....	10-11
Purging method: to use vacuum pump.....	12
Wiring work.....	13-15
Test running.....	16
Items to confirm.....	16
Trouble shooting.....	17

■ Cautions

Disposal of the old air conditioner

Before disposing an old air conditioner that goes out of use, please make sure it's inoperative and safe. Unplug the air conditioner in order to avoid the risk of child entrapment.

It must be noticed that air conditioner system contains refrigerants, which require specialized waste disposal. The valuable materials contained in a air conditioner can be recycled. Contact your local waste disposal center for proper disposal of an old air conditioner and contact your local authority or your dealer if you have any question. Please ensure that the pipework of your air conditioner does not get damaged prior to being picked up by the relevant waste disposal center, and contribute to environmental awareness by insisting on an appropriate, anti-pollution method of disposal.

Disposal of the packaging of your new air conditioner

All the packaging materials employed in the package of your new air conditioner may be disposed without any danger to the environment.

The cardboard box may be broken or cut into smaller pieces and given to a waste paper disposal service. The wrapping bag made of polyethylene and the polyethylene foam pads contain no fluorochloric hydrocarbon.

All these valuable materials may be taken to a waste collecting center and used again after adequate recycling.

Consult your local authorities for the name and address of the waste materials collecting centers and waste paper disposal services nearest to your house.

Safety Instructions and Warnings

Before starting the air conditioner, read the information given in the User's Guide carefully. The User's Guide contains very important observations relating to the assembly, operation and maintenance of the air conditioner.

The manufacturer does not accept responsibility for any damages that may arise due to non-observation of the following instruction.

- Damaged air conditioners are not to be put into operation. In case of doubt, consult your supplier.
- Use of the air conditioner is to be carried out in strict compliance with the relative instructions set forth in the User's Guide.
- Installation shall be done by professional people, don't install unit by yourself.
- For the purpose of safety, the air conditioner must be properly grounded in accordance with specifications.
- Always remember to unplug the air conditioner before opening inlet grill. Never unplug your air conditioner by pulling on the power cord. Always grip plug firmly and pull straight out from the outlet.

■ Cautions

- All electrical repairs must be carried out by qualified electricians. Inadequate repairs may result in a major source of danger for the user of the air conditioner.
 - Do not damage any parts of the air conditioner that carry refrigerant by piercing or perforating the air conditioner's tubes with sharp or pointed items, crushing or twisting any tubes, or scraping the coatings off the surfaces. If the refrigerant spurts out and gets into eyes, it may result in serious eye injuries.
 - Do not obstruct or cover the ventilation grille of the air conditioner. Do not put fingers or any other things into the inlet/outlet and swing louver.
 - Do not allow children to play with the air conditioner. In no case should children be allowed to sit on the outdoor unit.
4. The wiring method should be in line with the local wiring standard.
 5. The power cable and connecting cable are self-provided. All the cables shall have got the local authentication certificate. During installation, when the connecting cables break off, it must be assured that the grounding wire is the last one to be broken off.
 6. The breaker of the air conditioner should be all-pole switch; and the distance between its two contacts should be no less 3mm. Such means for disconnection must be incorporation in the fixed wiring.
 7. The waste battery shall be disposed properly.

Specifications

The refrigerating circuit is leak-proof.

The machine is adaptive in following situation

1. Applicable ambient temperature range:

Cooling	Indoor	Maximum:D.B/W.B	32°C/23°C
		Minimum:D.B/W.B	18°C/14°C
	Outdoor	Maximum:D.B	43°C/26°C
		Minimum:D.B	10°C/6°C
Heating	Indoor	Maximum:D.B	27°C
		Minimum:D.B	20°C
	Outdoor	Maximum:D.B/W.B	24°C/18°C
		Minimum:D.B/W.B	-15°C

2. If the supply cord is damaged, it must be replaced by the manufacturer or its service agent or a similar qualified person.

3. If the fuse on PC board is broken please change it with the type of T 3.15A /250VAC or T 25A/250VAC. Please check the circuit diagram about the fuse replaced.

■ Safety precautions

To ensure proper installation, please read this safety precautions carefully before the installation. After installation, start the unit correctly and ensure that you show the customer how to operate and maintain the units.

WARNING! Incorrect operations may result in severe consequences of death or serious injuries.

CAUTION! Incorrect operations may result in injuries or machine damages; in some cases may cause serious consequences.

WARNING

- Installation work must be carried out by professional qualified people, do not install the unit by yourself. Incorrect installation will cause water leakage, electric shock and potentially fire.
 - Install the unit as per the manual. Incorrect installation will cause water leakage, electric shock or fire risk.
 - Be sure to use specified accessories and parts. Otherwise, water leakage, electric shock, fire risk or unit falling down may occur .
 - Mounting position must be strong enough to hold the unit. Or, the unit will potentially fall down causing injuries.
 - When installing the unit, take in consideration storms and high winds. Incorrect installation may cause the unit to fall down.
 - All electric work should be carried out by experienced personnel as per current regulations and this manual. Incorrect installation or undersized electric cable may cause electric shock or fire risk.
 - All circuits must be earthed. Ensure that no external forces will affect the terminal block and electric cable. Poor wiring and installation may cause fire risk.
 - Arrange wire connection between connecting the indoor and outdoor power supply correctly. Fix terminal cover firmly to avoid overheating, electric shock or even fire risk.
- In the case of a refrigerant leakage during unit installation, keep the room well ventilated.
- Check the unit upon installation. Be sure there is no leakage. Refrigerant will induce a poisonous gas subject to heat.
 - Isolate power supply before touching terminal block.

WARNING



- All units shall be earthed. The earth must not be connected to a gas pipe, water pipe, or telephone line. Poor earthing could cause electric shock.
- Be sure to install a circuit breaker to avoid electric shock.
- Arrange water drainage according to this manual. Cover pipe with insulation materials to prevent condensation occurring. Improper installation of water drainage will cause water leakage.
- To maintain good picture or reduce noise, keep the unit at least 1m from T.V. or radio,
- when installing the communication wire and power supply. (If the radio wave is relatively strong, 1m is not enough to reduce the interference).
- Do not install the unit in following places:
 - (a) Oil mist or oil gas exists, such as kitchen, or, plastic parts may age, or water leakage.
 - (b) Where there is corrosive gas. Copper tube and welded part may be damaged due to corrosion causing leakage.

■ Safety precautions

- (c) Where there is strong radiation. It will affect the unit's control system, causing malfunction of the unit.
- (d) Where there are flammable gas, dirt, and volatile matter (thinner, gasoline) exist, these items will cause a fire risk.

■ Installation accessories

The following accessories are supplied together with the outdoor unit.

No.	Drawing	Name of parts	Quantity
1		Drainage elbow	1
2		Rubber cushion	4
3		Clap	1

■ Choose the installation place

- Place, robust not causing vibration, where the body can be supported sufficiently.
- Place, not affected by heat or steam generated in the vicinity, where inlet and outlet of the unit are not disturbed.
- Place, possible to drain easily, where piping can be connected with the outdoor.
- Place, where cold air can be spread in a room entirely.
- Place, nearby a power receptacle, with enough space around.(Refer to drawings).
- Place, where the distance of more than 1m from televisions, radios, wireless apparatuses and fluorescent lamps can be left.
- In the case of fixing the remote controller on a wall, place where the indoor unit can receive signals when the fluorescent lamps in the room are lightened.

■ Installation dimensions(mm)

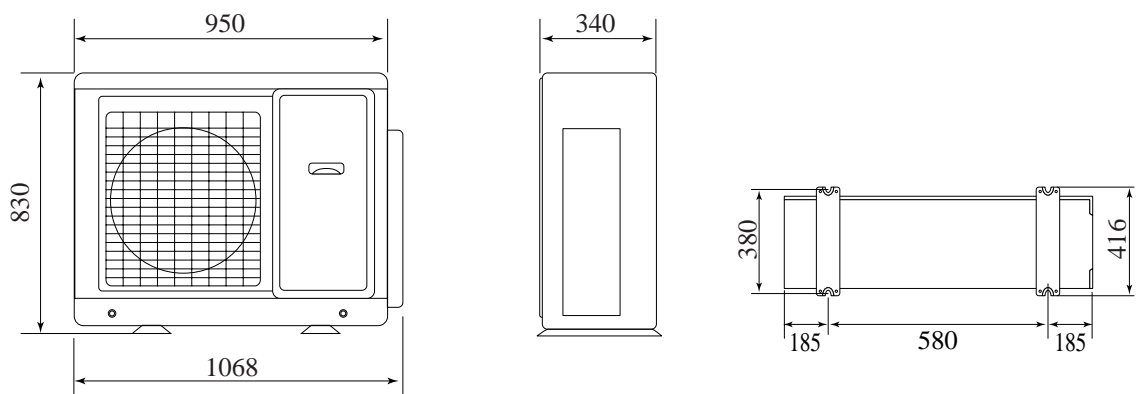

■ Installation drawings of indoor and outdoor units

1. Do not connected the embedded branch piping and the outdoor unit when only carrying out piping work without connecting the indoor unit in order to add another indoor unit later. Make sure no dirt or moisture gets into either side of the embedded branch piping.
2. It is impossible to connect the indoor unit for one room only. Be sure to connect at least 2 rooms.

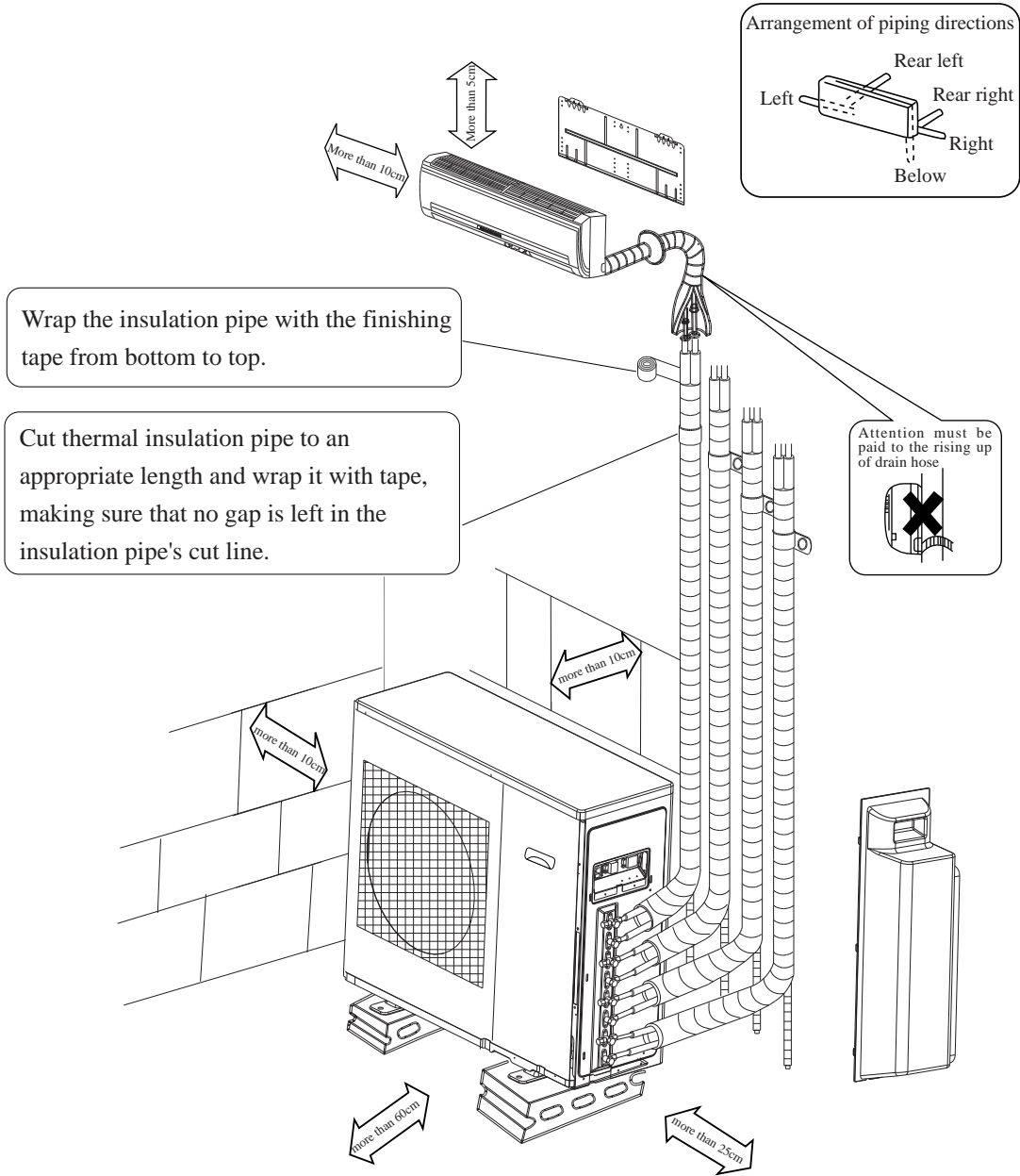

If there is the danger of the unit falling or overturning, fix the unit with foundation bolts, or with wire or other means.

If the location does not have good drainage, place the unit on a level mounting base(or a plastic pedestal).

Install the outdoor unit in a level position. Failure to do so may result in water leakage or accumulation.

■ Matching of the indoor and outdoor units

WARNING!

Combinations those marked * would not be applied where the temperature in winter is too low and in summer is too higher to avoid bad heating or cooling effect.

For AU282XHERA

Combination	A	B	C	D	Remark
1:2	07	18	-	-	-
	09	18	-	-	-
	12	14	-	-	-
	12	18	-	-	-
	14	14	-	-	-
	14	18	-	-	-
	18	18	-	-	*
1:3	07	07	12	-	-
	07	07	14	-	-
	07	07	18	-	-
	07	09	09	-	-
	07	09	12	-	-
	07	09	14	-	-
	07	09	18	-	*
	09	09	09	-	-
	09	09	12	-	-
	09	09	14	-	-
	09	09	18	-	*
	09	12	12	-	-
	09	12	14	-	*
	12	12	12	-	*
	12	12	14	-	*
	12	12	18	-	*
	12	14	14	-	*
12	14	18	-	*	
14	14	14	-	*	
1:4	07	07	07	07	-
	07	07	07	09	-
	07	07	07	12	-
	07	07	07	14	*
	07	07	07	18	*
	07	07	09	09	-
	07	07	09	12	-
	07	07	09	14	*
	07	07	09	18	*
	07	09	09	09	-
	07	09	09	12	*
	07	09	09	14	*
	07	09	09	18	*
	09	09	09	09	*
	09	09	09	12	*
	09	09	09	14	*
	09	09	12	12	*
	09	09	12	14	*
	09	12	12	12	*

■ Matching of the indoor and outdoor units

For AU342XHERA

Combination	A	B	C	D	Remark
1:2	12	18	-	-	
	14	14	-	-	-
	14	18	-	-	-
	18	18	-	-	-
1:3	07	07	14	-	*
	07	07	18	-	-
	07	09	12	-	-
	07	09	14	-	-
	07	09	18	-	-
	09	09	09	-	-
	09	09	12	-	-
	09	09	14	-	-
	09	09	18	-	-
	09	12	12	-	*
	09	12	14	-	-
	12	12	12	-	-
	12	12	14	-	*
	12	12	18	-	*
	12	14	14	-	*
	12	14	18	-	*
	14	14	14	-	*
14	14	18	-	*	
1:4	07	07	07	09	*
	07	07	07	12	-
	07	07	07	14	-
	07	07	07	18	-
	07	07	09	09	*
	07	07	09	12	-
	07	07	09	14	-
	07	07	09	18	*
	07	07	12	12	*
	07	07	12	14	*
	07	07	14	14	*
	07	09	09	09	*
	07	09	09	12	-
	07	09	09	14	*
	07	09	09	18	*
	07	09	12	12	*
	07	09	12	14	*
	09	09	09	09	*
	09	09	09	12	*
	09	09	09	14	*
	09	09	09	18	*
	09	09	12	12	*
09	09	12	14	*	
09	12	12	12	*	
12	12	12	12	*	

*

■ Power source

- Before inserting power plug into receptacle, check the voltage without fail. The power source is the same as the corresponded name plate.
- Install an exclusive branch circuit of the power.
- A receptacle shall be set up in a distance where the power cable can be reached. Do not extend the cable by cutting it.

■ Limitations on the installation

1. Precautions on installation

- Check the strength and level of the installation ground so that unit will not cause any operating vibration or noise after installation.
- In accordance with the foundation drawing in fix the unit securely by means of the foundation bolts.
- It is best to screw in the foundation bolts unit their length are 20 mm from the foundation surface.

2. Selecting a location for installation of the indoor units

- The maximum allowable length of refrigerant piping, and the maximum allowable height difference between the outdoor and indoor units, are listed below.

(The shorter the refrigerant piping, the better the performance. Connect so that the piping is as short as possible. Shortest allowable length per room is 3m)

Outdoor unit capacity class	AU282XHERA AU342XHERA
Piping to each indoor unit	25m max.
Total length of liquid piping between all units	60m max.

■ Limitations on the installation

3. Limitations values on the piping work .

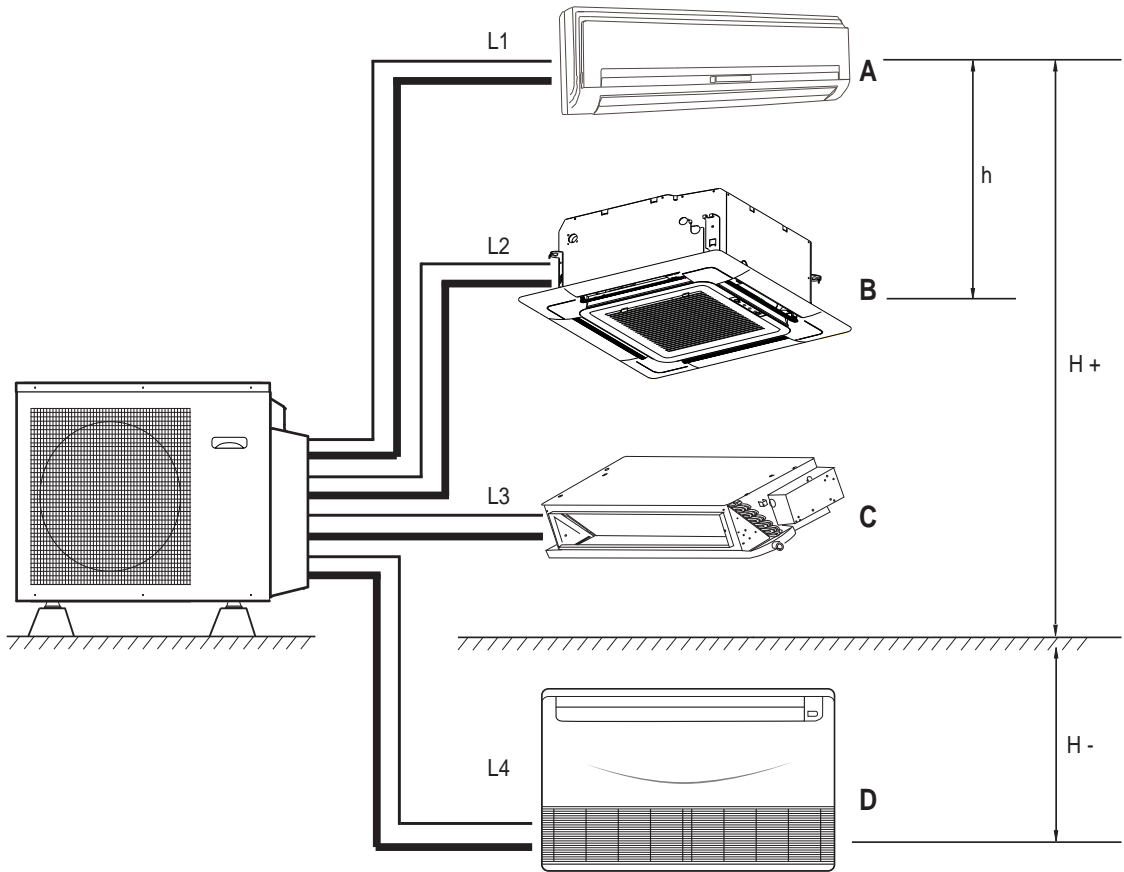

The piping length information, please refer the following table.

Item	Unit	Descriptions	Standard	Maximum
A, B, C,D liquid pipe	mm	Size of the liquid side connection pipe	$\varnothing 6.35$	/
A, B, C,D Gas pipe	mm	Size of the gas side connection pipe	$\varnothing 9.52$	/
L1 (one way)	m	Pipe length when the compressor connects with two indoor units	≤ 10	≤ 25
L2 (one way)	m	Pipe length when the compressor connects with two indoor units	≤ 10	≤ 25
L3 (one way)	m	Pipe length when the compressor connects only one indoor unit	≤ 10	≤ 25
L4 (one way)	m	Pipe length when the compressor connects only one indoor unit	≤ 10	≤ 25
L1+L2+L3+L4	m	Total liquid piping length(It is no need to charge additional refrigerant within this value)	≤ 40	≤ 60
h	m	Drop between every two indoor units	≤ 1	≤ 5
H +	m	Drop between the outdoor unit and the indoor unit	≤ 5	≤ 15
H -	m	Drop between the outdoor unit and the indoor unit	≤ 5	≤ 10

■ Refrigerant piping work

1. Selection of pipe

- To this unit, both liquid and gas pipes shall be insulated as they become low temperature in operation.
- Use optional parts for piping set or pipes covered with equivalent insulation material.

Liquid pipe	∅ 6.35mm (1/4") x 0.8mm
Gas pipe	∅ 9.52mm (3/8") x 0.8mm

2. Connection of pipe

- Apply refrigerant oil on half union and flare nut.
- To bend a pipe, give the roundness as large as possible not to crush the pipe.
- Connecting the pipe of gas side firstly makes working easier.

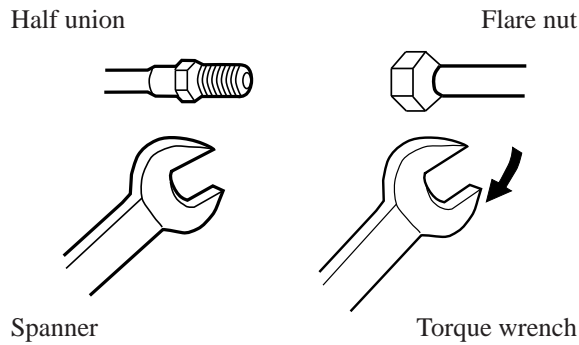

Forced fastening without careful centering may damage the threads and cause a leakage of gas.

Pipe Diameter (∅)	Fastening Torque
Liquid Side 6.35mm (1/4")	18N.m
Gas Side 9.52mm (3/8")	50N.m

3. Attaching Drain-Elbow

- If the drain-elbow is used, please attach it as figure.

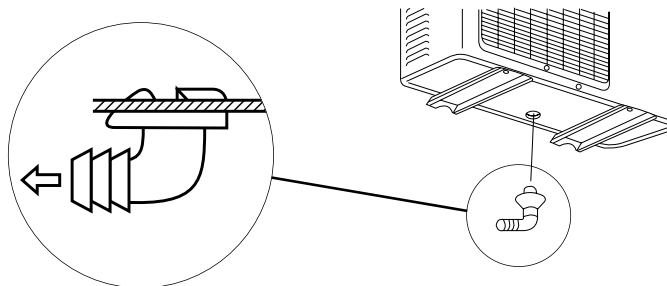

■ Refrigerant piping work

4. Cutting and Flaring work of piping

- Pipe cutting is carried out with a pipe cutter and burs must be removed.

After inserting the flare nut, flaring work is carried out.

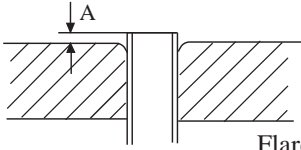

Flare tooling die

	Pipe diameter*	Size A (mm)
Liquid side	6.35mm(1/4")	0.8~1.5
Gas side	9.52mm(3/8")	1.0~1.5

Correct	Incorrect				
	Lean	Damage of flare	Crack	Partial	Too outside

5. On drainage

- Please install the drain hose so as to be downward slope without fail.
- Please don't do the drainage as shown below.

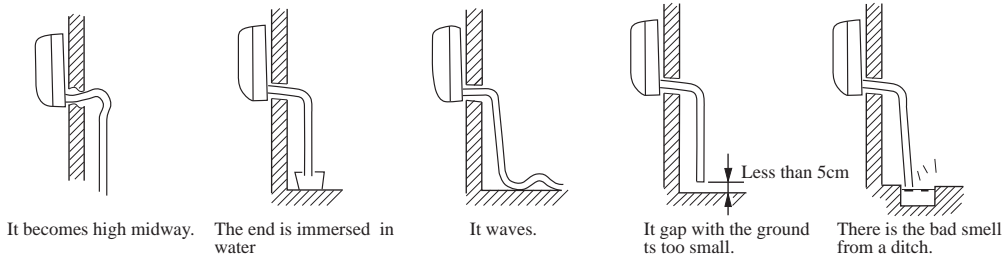

- Please pour water in the drain pan of the indoor unit, and confirm that drainage is carried out serenely to outdoor.
- In case that the attached drain hose is in a room, please apply heat insulation to it without fail.

■ Purging method: to use vacuum pump

① Detach the service ports cap of 3-way valve, the valve rod's cap for 2-way valve and 3-way valves, connect the service port into the projection of charge hose (low) for gaugemanifold. Then connect the projection of charge hose (center) for gaugemanifold into vacuum pump.

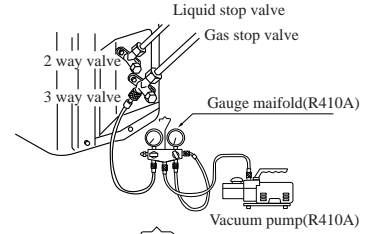

② Open the handle at low in gaugemanifold, operate vacuum pump. If the scale-moves of gauge (low) reach vacuum condition in a moment, check ① again.



③ Vacuumize for over 15min. And check the level gauge which should read -0.1MPa (-76 cm Hg) at low pressure side. After the completion of vacuumizing, close the handle 'Lo' in the vacuum pump. Check the condition of the scale and hold it for 1-2min. If the scale-moves back in spite of tightening, make flaring work again, then return to the beginning of ③.

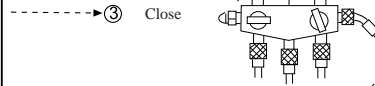

④ Open the valve rod for the 2-way valve to and an angle of anticlockwise 90 degree. After 6 seconds, close the 2-way valve and make the inspection of gas leakage.

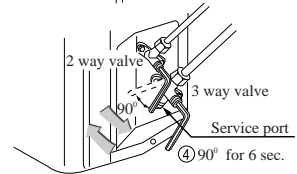

⑤ No gas leakage?

In case of gas leakage, tighten parts of pipe connection. If leakage stops, then proceed ⑥ steps.

If it does not stop gas leakage, discharge whole refrigerants from the service port. After flaring work again and vacuumize, fill up prescribed refrigerant from the gas cylinder.

⑥ Detach the charge hose from the service port, open 2-way valve and 3-way. Turn the valve rod anticlockwise until hitting lightly.

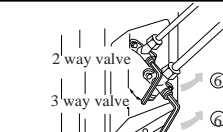

⑦ To prevent the gas leakage, turn the service ports cap, the valve rod's cap for 2-way valve and 3-way's a little more than the point where the torque increases suddenly.

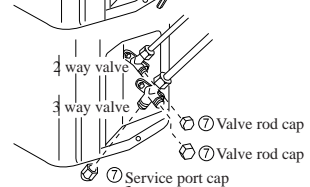

⑧ Take the same steps from ① to ⑦ for each ways to ensure a completely vacuum for the whole system.

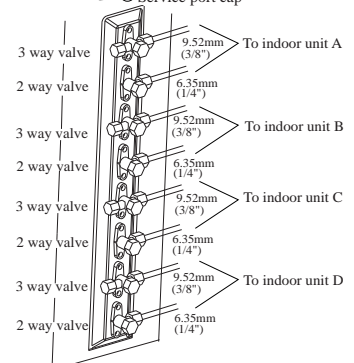

CAUTION: If the refrigerant of the air conditioner leaks, it is necessary to make all the refrigerant out. Vacuumize first, then charge the liquid refrigerant into air conditioner according to the amount marked on the name plate.

■ Wiring work

1. Electric wiring

Note:

- The air conditioner must use special circuit , and wiring by the qualified electrician according to the wiring rules specified in national standard.
- The grounding wire and the neutral wire shall be strictly separated. Connect the neutral wire with grounding wire is incorrect.
- The electric leakage breaker must be installed.
- All the electric wire must be copper wire. When wiring, there shall keep a proper distance between the power line and communication wire to avoid twist together. Otherwise, signal disturbance will occur, and the air conditioner can not operate normally. Power supply: 1PH, 220-230V~, 50Hz.
- The wiring method of power line is Y connection. If the power line is damaged, in order to avoid risk of electric shock, it must be replaced by the manufacturer or its repair center or other similar qualified person. The connecting cable must be shielded.
- Fuse: T3.15A 250VAC T25A 250VAC (Please check with the outdoor unit wiring diagram.)
- Please check the circuit diagram about the fuse replaced.

2. Wiring method

- Wiring method of orbicular terminals

For the connection wire with orbicular terminals, its wiring method is as shown in the right figure: remove the connecting screw, put the screw through the ring on the end of the wire, then connect to the terminal block and fasten screw.

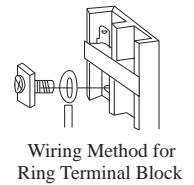

- Wiring method of straight terminals

For the connection wire without orbicular terminals, its wiring method is: loosen the connection screw, and insert the end of the connection wire completely into the Terminal block, then fasten the screw. Slightly pull the wire outwards to confirm it is firmly held.

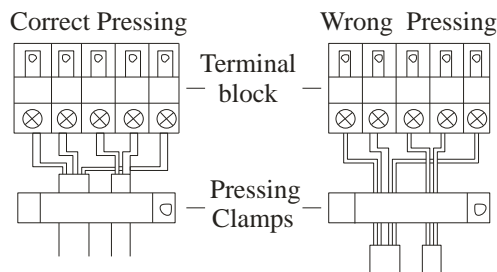

- Crimp connection method for wires without terminals

Connect the wire with same diameter to the two sides of the terminal

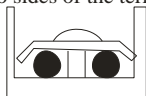

Do not connect the wire with same diameter to the same side

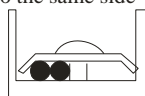

Do not connect the wire with different diameters

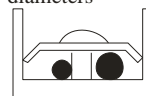

■ Wiring work

Crimp connection method for connection wire

After connection, the wire must be fastened by wire cover. The wire cover shall press on the protection coat of the connection wire, as shown in right top figure.

Note: When connecting the wiring, confirm the terminal number of indoor and outdoor units carefully. Incorrect wiring will damage the controller of air conditioner or the unit can not operate.

3. Wiring method of outdoor unit:

• Power line

Remove the repair board of the outdoor unit and loosen the wire cover A, then put the live wire, neutral wire and grounding wire through the wire cover, and connect them to terminal block correspondingly. After connection, fasten wire cover to its previous state.

• Communication wire of indoor unit.

Loosen wire cover, put the communication wire through the wire cover B, and connect them to terminal block correspondingly. After connection, fasten wire cover B to its previous state.

Note: Power line and communication wire are provided by consumers themselves.

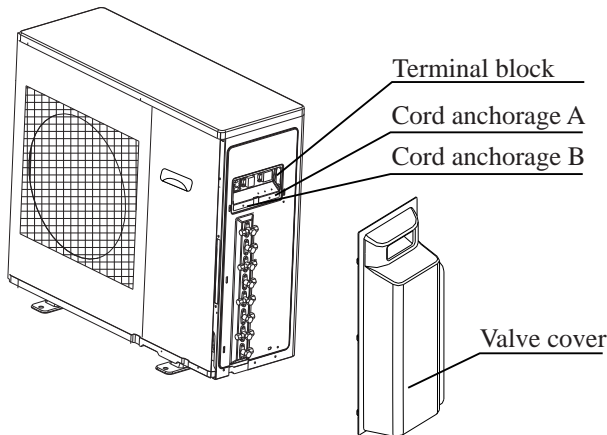

4. Wiring method of indoor unit

Loosen wire cover and connect the power line and communication wire of indoor unit to the terminal correspondingly.

Note:

When connecting power line to power supply terminal, please pay attention to the following items:

- Do not connect the power line with different dimensions to the same connection wire end. Improper contact will cause heat generation.
- Do not connect the power line with different dimensions to the same grounding wire end. Improper contact will affect protection.
- Keep a proper distance between the communication wire and the power line. Otherwise, abnormal communication will occur because of disturbance. And also, the communication wires should be shielded wire, and the shield cover should be grounded on the outdoor unit.
- Do not connect the power line to the connecting end of communication wire. Incorrect connection will cause damage to the connected unit.

■ Wiring work

5. Example wiring diagram.

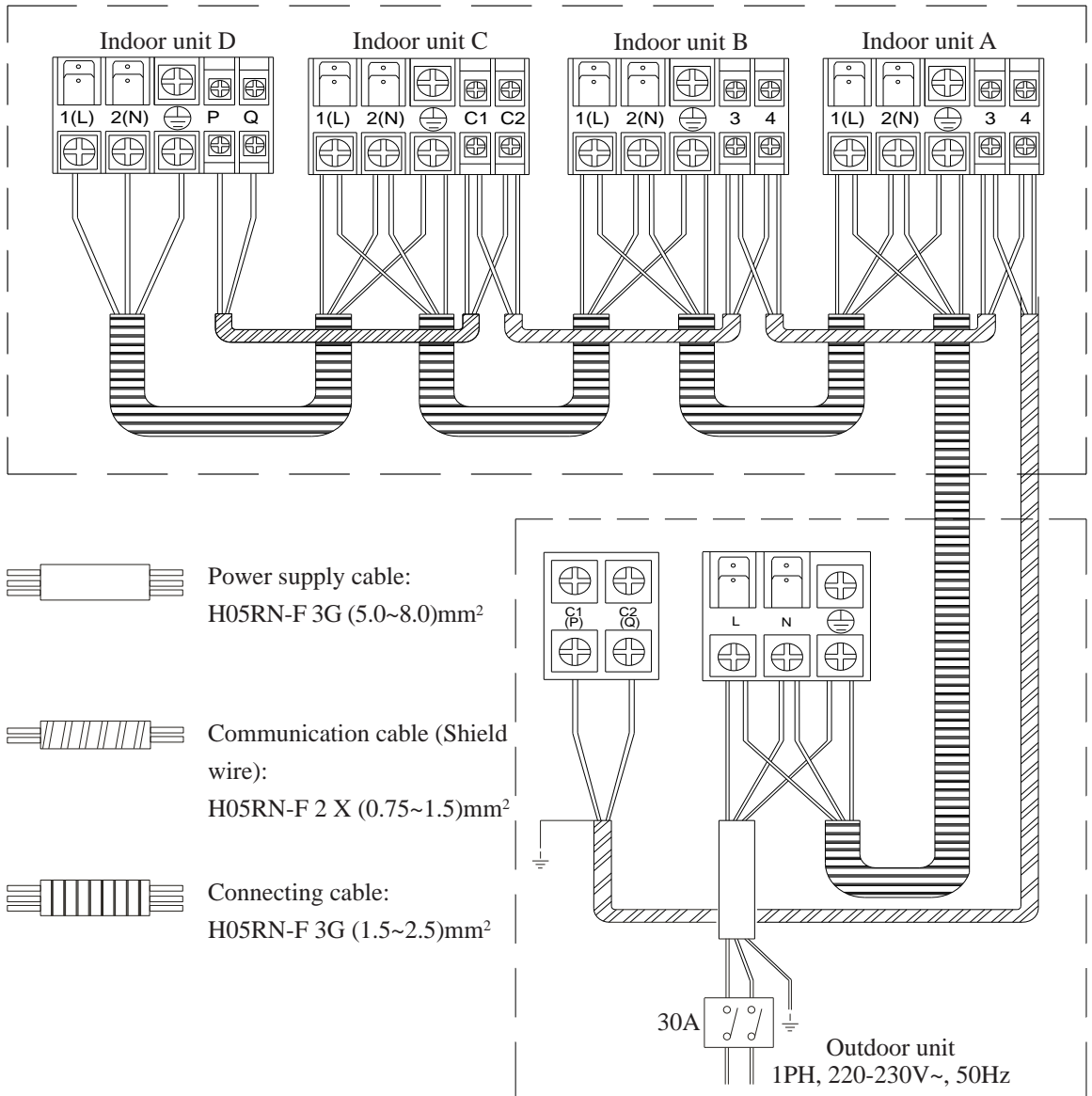

- Please refer to the indoor unit installation manual to find detailly how to set and check the communication address.
- Incorrect address setting will cause abnormal to the system.

6. After installation, please fill in the following table for easy daily maintenance:

Indoor unit NO.	Room name	Model of indoor unit	Serial no.
A			
B			
C			
D			

■ Test running

- Before starting the test running, please confirm the following works have been done successfully.
 - 1) Correct piping work;
 - 2) Correct wiring work;
 - 3) Correct match of indoor and outdoor unit;
 - 4) Proper recharge of refrigerant if needed;
 - 5) Correct indoor unit addresses setting.
- Make sure that all the stop valves are fully open.
- Check the voltage supplied to the outdoor and indoor units, please confirm that is 230V.
- Test running.
 - 1) If the temperature is lower than 16 °C, it is impossible to test cooling with remote controller, and also when the temperature is higher than 30 °C, it is impossible to test heating.
 - 2) To test cooling, set the lowest temperature at 16 °C. To test heating, set the highest temperature, at 30°C.
 - 3) Please check both cooling and heating operation of each unit individually and then also check the simultaneous operation of all indoor units.
 - 4) After running the unit for about 20 minutes, check the indoor unit outlet temperature.
 - 5) After the unit is stopped, or working mode changed, the system will not start again for about 3 minutes.
 - 6) During cooling operation, frost may occur on the indoor unit or pipes, this is normal.
 - 7) Operate the unit according to the operation manual. Please kindly explain to our customers how to operate through the instruction manual.

■ Items to confirm

Check items for test run, put mark "✓ in ".

- Gas leakage from pipe connection?
- Heat insulation treatment of pipe connection?
- Are the connection wiring of indoor and outdoor unit firmly inserted into the terminal block?
- Is the connection wiring of indoor and outdoor firmly fixed?
- Is drainage securely arranged?
- Is the ground wire securely and firmly connected?
- Is power supply voltage abided by electric code?
- Is there any noise?
- Does cooling perform normally?
- Does room temperature regulator operate normally?

■ Trouble shooting

FAILURE CODE	STATE OF LED 5-4-3-2-1	TROUBLE SHOOTING	POSSIBLE REASONS
1	○○○○●	Faulty defrost sensor Te	Sensor disconnected, or broken, or short circuit
2	○○○●○	Faulty sensor Tao	Sensor disconnected, or broken, or short circuit
3	○○○●●	Faulty sensor Ts	Sensor disconnected, or broken, or short circuit
4	○○●○○	Faulty sensor Td	Sensor disconnected, or broken, or short circuit
5	○○●○○	Input overcurrent	Over current of the system, or broken of the current sensor, or malfunction with indoor or outdoor fan motors, or faulty PCB.
6	○○●●○○	Abnormal communication between indoor and outdoor units	Wrong connection, or the wires be disconnected, or wrong address setting of indoor units, or faulty PCB, or faulty power supply
9	○●○○●	System high pressure protection	High pressure switch is disconnected, or high pressure switch worked, or Tc too high and faulty outdoor fan motor when cooling, or faulty indoor fan motors when heating, or refrigerant overabundance
10	○●○○○○	System low pressure protection	Low pressure switch is disconnected, or low pressure switch worked, or Te too low and faulty outdoor fan motors when heating, or faulty indoor fan motor when cooling, or refrigerant shortage
11	○●○○●●	IPM protection	IPM over current, or short circuit, or IPM temperature too high, or IPM input voltage too low, or faulty SPDU(or ISPM).
12	○●●○○○	EEPROM fault	Faulty outdoor unit PCB
13	○●●○○●	Over hot protection of compressor	Serious lack of refrigerant of the system, or the ambient temperature too high, or PMVs be blocked
14	○●●●○○	Over hot protection of SPDU (or ISPM)	Ambient tempreatrue too high, or outdoor fan be blocked, or bad air circulation of outdoor unit
15	○●●●●●	DC fan motor fault	Fan is blocked, or the terminal is disconnected from the PCB
16	●○○○○○	Faulty 4-way valve switching on	Coil of 4-way valve is disconnected, or faulty outdoor PCB
17	●○○○●	Faulty sensor Tc	Sensor disconnected, or broken, or short circuit
21	●○○○●	Faulty sensor Toci	Sensor disconnected, or broken, or short circuit
23	●○●●●●	Low voltage protection	VDC<194V, too low voltage from power source
24	●●○○○○	High voltage protection	VDC>400V, too high voltage from power source
25	●●○○●	Abnormal communication between main PCB and SPDU(or ISPM)	Communication cables broken, or not be well connected, or faulty main PCB, or faulty SPDU(or ISPM)
26	●●○○○○	Compressor be locked	Faulty compressor or SPDU(or ISPM)
27	●●○●●●	Compressor vibration too big	Faulty compressor
28	●●●○○○	Compressor lose position	Faulty SPDU(or ISPM)
29	●●●○●●	Faulty compressor start	Faulty compressor or SPDU(or ISPM)
30	●●●●○○	Faulty position checking circuit	Faulty SPDU(or ISPM)
31	●●●●●●	Compressor broken	Faulty compressor or SPDU(or ISPM)

Take off the plastic cover on the right side of the unit, you can find the LEDs near the communication terminal. Symbol● means the LED is ON, and symbol○ means the LED is OFF.

HAIER GROUP

Qingdao Haier Air Conditioner Electric Co., Ltd.

Address: Haier Garden, Qianwangang Road, Economic Development Zone,
Qingdao, Shandong 266555, P.R.China

Web Site: <http://www.haier.com>