

FUJIFILM

BL01051-200 **EN**

DIGITAL CAMERA

FINEPIX Z800EXR

Owner's Manual

Thank you for your purchase of this product. This manual describes how to use your FUJIFILM FinePix Z800EXR digital camera and the supplied software. Be sure that you have read and understood its contents before using the camera.

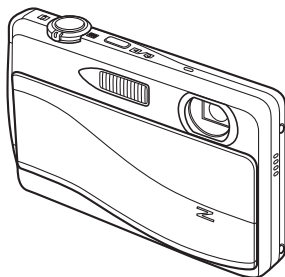

For information on related products, visit our website at http://www.fujifilm.com/products/digital_cameras/index.html

Exif Print



SUPER CCD EXR

Before You Begin

First Steps

Basic Photography and Playback

More on Photography

More on Playback

Movies

Connections

Menus

Technical Notes

Troubleshooting

Appendix

For Your Safety

IMPORTANT SAFETY INSTRUCTIONS

- **Read Instructions:** All the safety and operating instructions should be read before the appliance is operated.
- **Retain Instructions:** The safety and operating instructions should be retained for future reference.
- **Heed Warnings:** All warnings on the appliance and in the operating instructions should be adhered to.
- **Follow Instructions:** All operating and use instructions should be followed.

Installation

Power Sources: This video product should be operated only from the type of power source indicated on the marking label. If you are not sure of the type of power supply to your home, consult your appliance dealer or local power company. For video products intended to operate from battery power, or other sources, refer to the operating instructions.

Grounding or Polarization: This video product is equipped with a polarized alternating-current line plug (a plug having one blade wider than the other). This plug will fit into the power outlet only one way. This is a safety feature. If you are unable to insert the plug fully into the outlet, try reversing the plug. If the plug should still fail to fit, contact your electrician to replace your obsolete outlet. Do

not defeat the safety purpose of the polarized plug.

Alternate Warnings: This video product is equipped with a 3-wire grounding-type plug, a plug having a third (grounding) pin. This plug will only fit into a grounding-type power outlet. This is a safety feature. If you are unable to insert the plug into the outlet, contact your electrician to replace your obsolete outlet. Do not defeat the safety purpose of the grounding-type plug.

Overloading: Do not overload wall outlets and extension cords as this can result in a risk of fire or electric shock.

Ventilation: Slots and openings in the cabinet are provided for ventilation and to ensure reliable operation of the video product and to protect it from overheating, and these openings must not be blocked or covered.

The openings should never be blocked by placing the video product on a bed, sofa, rug, or other similar surface.

This video product should not be placed in a built-in installation such as a bookcase or rack unless proper ventilation is provided or the manufacturer's instructions have been adhered to.

This video product should never be placed near or over a radiator or heat register.

Attachments: Do not use attachments not recommended by the video product manufacturer as they may cause hazards.

Water and Moisture: Do not use this video product near water – for example, near a bath tub, wash bowl, kitchen sink, or laundry tub, in a wet basement, or near a swimming pool, and the like.

Power-Cord Protection: Power-Supply cords should be routed so that they are not likely to be walked on or pinched by items placed upon or against them, paying particular attention to cords at plugs, convenience receptacles, and the point where they exit from the appliance.

Accessories: Do not place this video product on an unstable cart, stand, tripod, bracket, or table. The video product may fall, causing serious injury to a child or adult, and serious damage to the appliance. Use only with a cart, stand, tripod, bracket, or table recommended by the manufacturer, or sold with the video product. Any mounting of the appliance should follow the manufacturer's instructions, and should use a mounting accessory recommended by the manufacturer.

An appliance and cart combination should be moved with care. Quick stops, excessive force, and uneven surfaces may cause the appliance and cart combination to overturn.



Antennas

Outdoor Antenna Grounding: If an outside antenna or cable system is connected to the video product, be sure the antenna or cable system is grounded so as to provide some protection against voltage surges and built-up static charges. Section 810 of the National Electrical Code, ANSI/NFPA No. 70, provides information with respect to proper grounding of the mast and supporting structure, grounding of the lead-in wire to an antenna-discharge unit, size of grounding conductors, location of antenna-discharge unit, connection to grounding electrodes, and requirements for the grounding electrode.

Power Lines: An outside antenna system should not be located in the vicinity of overhead power lines or other electric light or power circuits, or where it can fall into such power lines or circuits. When installing an outside antenna system, extreme care should be taken to keep from touching such power lines or circuits as contact with them might be fatal.

EXAMPLE OF ANTENNA GROUNDING AS PER NATIONAL ELECTRICAL CODE

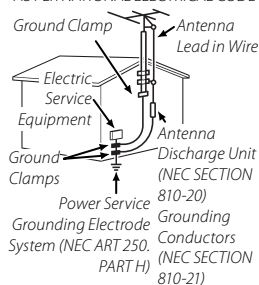

Use

Cleaning: Unplug this video product from the wall outlet before cleaning. Do not use liquid cleaners or aerosol cleaners. Use a damp cloth for cleaning.

Object and Liquid Entry: Never push objects of any kind into this video product through openings as they may touch dangerous voltage points or short out parts that could result in a fire or electric shock. Never spill liquid of any kind on the video product.

Lightning: For added protection for this video product receiver during a lightning storm, or when it is left unattended and unused for long periods of time, unplug it from the wall outlet and disconnect the antenna or cable system. This will prevent damage to the video product due to lightning and power-line surges.

Service

Service: Do not attempt to service this video product yourself as opening or removing covers may expose you to dangerous voltage or other hazards. Refer all servicing to qualified service personnel.

Damage Requiring Service: Unplug this video product from the wall outlet and refer servicing to qualified service personnel under the following conditions:

When the power-supply cord or plug is damaged.

If liquid has been spilled, or objects have fallen into the video product.

If the video product has been exposed to rain or water.

If the video product has been dropped or the cabinet has been damaged.

If the video product does not operate normally be following the operating instructions. Adjust only those controls that are covered by the operating instructions as an improper adjustment of other controls may result in damage and will often require extensive work by a qualified technician to restore the video product to its normal operation.

When the video product exhibits a distinct change in performance - this indicates a need for service.

Replacement Parts: When replacement parts are required, be sure the service technician has used replacement parts specified by the manufacturer or have the same characteristics as the original part. Unauthorized substitutions may result in fire, electric shock or other hazards.

Safety Check: Upon completion of any service or repairs to this video product, ask the service technician to perform safety checks to determine that the video product is in proper operating condition.



Be sure to read this notes before using

Safety Notes



- Make sure that you use your camera correctly. Read these Safety Notes and your *Owner's Manual* carefully before use.
- After reading these Safety Notes, store them in a safe place.

About the Icons

The icons shown below are used in this document to indicate the severity of the injury or damage that can result if the information indicated by the icon is ignored and the product is used incorrectly as a result.

	WARNING	This icon indicates that death or serious injury can result if the information is ignored.
	CAUTION	This icon indicates that personal injury or material damage can result if the information is ignored.









The icons shown below are used to indicate the nature of the information which is to be observed.

	Triangular icons tell you that this information requires attention ("important").
	Circular icons with a diagonal bar tell you that the action indicated is prohibited ("Prohibited").
	Filled circles with an exclamation mark tell you an action that must be performed ("Required").

WARNING

	If a problem arises, turn the camera off, remove the battery, disconnect and unplug the AC power adapter. Continued use of the camera when it is emitting smoke, is emitting any unusual odor, or is in any other abnormal state can cause a fire or electric shock. • Contact your FUJIFILM dealer.
--	---

WARNING

	Do not allow water or foreign objects to enter the camera. If water or foreign objects get inside the camera, turn the camera off, remove the battery and disconnect and unplug the AC power adapter. Continued use of the camera can cause a fire or electric shock. • Contact your FUJIFILM dealer.
 <i>Do not use in the bathroom or shower.</i>	Do not use the camera in the bathroom or shower. This can cause a fire or electric shock.
 <i>Do not disassemble</i>	Never attempt to disassemble or modify (never open the case). Failure to observe this precaution can cause fire or electric shock.
 <i>Do not touch internal parts</i>	Should the case break open as the result of a fall or other accident, do not touch the exposed parts. Failure to observe this precaution could result in electric shock or injury from touching the damaged parts. Remove the battery immediately, taking care to avoid injury or electric shock, and take the product to the point of purchase for consultation.
	Do not change, heat or unduly twist or pull the connection cord and do not place heavy objects on the connection cord. These actions could damage the cord and cause a fire or electric shock. • If the cord is damaged, contact your FUJIFILM dealer.
	Do not place the camera on an unstable surface. This can cause the camera to fall or tip over and cause injury.
	Never attempt to take pictures while in motion. Do not use the camera while you are walking or driving a vehicle. This can result in you falling down or being involved in a traffic accident.
	Do not touch any metal parts of the camera during a thunderstorm. This can cause an electric shock due to induced current from the lightning discharge.
	Do not use the battery except as specified. Load the battery as aligned with the indicator.

⚠ WARNING

Do not heat, change or take apart the battery. Do not drop or subject the battery to impacts. Do not store the battery with metallic products. Do not use chargers other than the specified model to charge the battery.

Any of these actions can cause the battery to burst or leak and cause fire or injury as a result.



Use only the battery or AC power adapters specified for use with this camera. Do not use voltages other than the power supply voltage shown.

The use of other power sources can cause a fire.



If the battery leaks and fluid gets in contact with your eyes, skin or clothing. Flush the affected area with clean water and seek medical attention or call an emergency number right away.



Do not use the charger to charge batteries other than those specified here.

The Ni-MH battery charger is designed for FUJIFILM HR-AA Ni-MH batteries. Using the charger to charge conventional batteries or other types of rechargeable batteries can cause the battery to leak fluid, overheat or burst.



When carrying the battery, install it in a digital camera or keep it in the hard case. When storing the battery, keep it in the hard case. When discarding, cover the battery terminals with insulation tape.

Contact with other metallic objects or battery could cause the battery to ignite or burst.



Keep Memory Cards out of the reach of small children.

Because Memory Cards are small, they can be swallowed by children. Be sure to store Memory Cards out of the reach of small children. If a child swallows a Memory Card, seek medical attention or call an emergency number.

⚠ CAUTION

Do not use this camera in locations affected by oil fumes, steam, humidity or dust.

This can cause a fire or electric shock.



Do not leave this camera in places subject to extremely high temperatures.

Do not leave the camera in locations such as a sealed vehicle or in direct sunlight. This can cause a fire.



Keep out of the reach of small children.

This product could cause injury in the hands of a child.

⚠ CAUTION

Do not place heavy objects on the camera.

This can cause the heavy object to tip over or fall and cause injury.



Do not move the camera while the AC power adapter is still connected. Do not pull on the connection cord to disconnect the AC power adapter.

This can damage the power cord or cables and cause a fire or electric shock.



Do not use the AC power adapter when the plug is damaged or the plug socket connection is loose.

This could cause a fire or electric shock.



Do not cover or wrap the camera or the AC power adapter in a cloth or blanket.

This can cause heat to build up and distort the casing or cause a fire.



When you are cleaning the camera or you do not plan to use the camera for an extended period, remove the battery and disconnect and unplug the AC power adapter.

Failure to do so can cause a fire or electric shock.



When charging ends, unplug the charger from the power socket.

Leaving the charger plugged into the power socket can cause a fire.



Using a flash too close to a person's eyes may temporarily affect the eyesight.

Take particular care when photographing infants and young children.



When a memory card is removed, the card could come out of the slot too quickly. Use your finger to hold it and gently release the card.



Request regular internal testing and cleaning for your camera.

Build-up of dust in your camera can cause a fire or electric shock.

- Contact your FUJIFILM dealer to request internal cleaning every 2 years.

- Please note this is not a free of charge service.

Power Supply and Battery

* Confirm your battery type before reading the following descriptions.

The following explains proper use of batteries and how to prolong their life. Incorrect use of batteries can cause shorter battery life, as well as leakage, excessive heat, fire or explosion.

1 Camera uses the Rechargeable Lithium-ion Battery

* When shipped, the battery is not fully charged. Always charge the battery before using it.

* When carrying the battery, install it in a digital camera or keep it in the soft case.

■ Battery Features

- The battery gradually loses its charge even when not used. Use a battery that has been charged recently (in the last day or two) to take pictures.
- To maximize the life of the battery, turn the camera off as quickly as possible when it is not being used.
- The number of available frames will be lower in cold locations or at low temperatures. Take along a spare fully charged battery. You can also increase the amount of power produced by putting the battery in your pocket or another warm place to heat it and then loading it into the camera just before you take a picture.

If you are using a heating pad, take care not to place the battery directly against the pad. The camera may not operate if you use a depleted battery in cold conditions.

■ Charging the Battery

- You can charge the battery using the battery charger (included).

- The battery can be charged at ambient temperatures between 0°C and +40°C (+32°F and +104°F). Refer to the *Owner's Manual* for the time of charging battery.

- You should charge the battery at an ambient temperature between +10°C and +35°C (+50°F and +95°F). If you charge the battery at a temperature outside this range, charging takes longer because the performance of the battery is impaired.

- You cannot charge the battery at temperatures of 0°C (+32°F) or below.

- The Rechargeable Lithium-ion Battery does not need to be fully discharged or exhausted flat before being charged.
- The battery may feel warm after it has been charged or immediately after being used. This is perfectly normal.
- Do not recharge a fully charged battery.

■ Battery Life

At normal temperatures, the battery can be used at least 300 times. If the time for which the battery provides power shortens markedly, this indicates that the battery has reached the end of its effective life and should be replaced.

■ Notes on storage

- If a battery is stored for long periods while charged, the performance of the battery can be impaired. If the battery will not be used for some time, run the battery out before storing it.
- If you do not intend to use the camera for a long period of time, remove the battery from the camera.
- Store the battery in a cool place.
 - The battery should be stored in a dry location with an ambient temperature between +15°C and +25°C (+59°F and +77°F).
 - Do not leave the battery in hot or extremely cold places.

■ Handling the Battery Cautions for Your Safety:

- Do not carry or store battery with metal objects such as necklaces or hairpins.
- Do not heat the battery or throw it into a fire.
- Do not attempt to take apart or change the battery.
- Do not recharge the battery with chargers other than those specified.

- Dispose of used battery promptly.
- Do not drop the battery or otherwise subject it to strong impacts.
- Do not expose the battery to water.
- Always keep the battery terminals clean.
- Do not store batteries in hot places. Also, if you use the battery for a long period, the camera body and the battery itself will become warm. This is normal. Use the AC power adapter if you are taking pictures or viewing images for a long period of time.

2 Camera uses AA-size alkaline or Ni-MH (nickel-metal hydride) rechargeable batteries

* For details on the batteries that you can use, refer to the *Owner's Manual* of your camera.

■ Cautions for Using Battery

- Do not heat the batteries or throw them into a fire.
- Do not carry or store batteries with metal objects such as necklaces or hairpins.
- Do not expose the batteries to water, and keep batteries from getting wet or stored in moist locations.
- Do not attempt to take apart or change the batteries, including battery casings.
- Do not subject the batteries to strong impacts.
- Do not use batteries that are leaking, deformed, discolored.

- Do not store batteries in warm or humid places.
- Keep the batteries out of reach of babies and small children.
- Make sure that the battery polarity (⊕ and ⊖) is correct.
- Do not use new with used batteries. Do not use charged and discharged batteries together.
- Do not use different types or brands of batteries at the same time.
- If you do not intend to use the camera for a long period of time, remove the batteries from the camera. Note if the camera is left with the batteries removed, the time and date settings are cleared.
- The batteries feel warm right after being used. Before removing the batteries, turn the camera off and wait for the batteries to cool down.
- Since batteries do not work well in cold weather or locations, warm the batteries by placing them inside your garments before use. Batteries do not work well when cold. They will work again when the temperature returns to normal.
- Soil (such as fingerprints) on the battery terminals makes the batteries charge less reducing the number of images. Carefully wipe the battery terminals with a soft dry cloth before loading.



If any liquid at all leaks from the batteries, wipe the battery compartment thoroughly and then load new batteries.



If any battery fluid comes into contact with your hands or clothing, flush the area thoroughly with water. Note that battery fluid can cause loss of eyesight if it gets into your eyes. If this occurs, do not rub your eyes. Flush the fluid out with clean water and contact your physician for treatment.

■ Using the AA-size Ni-MH batteries correctly

- Ni-MH batteries left unused in storage for long periods can become “deactivated”. Also, repeatedly charging Ni-MH batteries that are only partially discharged can cause them to suffer from the “memory effect”. Ni-MH batteries that are “deactivated” or affected by “memory” suffer from the problem of only providing power for a short time after being charged. To prevent this problem, discharge and recharge them several times using the camera’s “Discharging rechargeable batteries” function. Deactivation and memory are specific to Ni-MH batteries and are not in fact battery faults.

See *Owner’s Manual* for the procedure for “Discharging rechargeable batteries”.

⚠ CAUTION

Do not use the “Discharging rechargeable batteries” function when alkaline batteries being used.

- To charge Ni-MH batteries, use the quick battery charger (sold separately). Refer to the instructions supplied with the charger to make sure that the charger is used correctly.
- Do not use the battery charger to charge other batteries.
- Note that the batteries feel warm after being charged.
- Due to the way the camera is constructed, a small amount of current is used even when the camera is turned off. Note in particular that leaving Ni-MH batteries in the camera for a long period will over-discharge the batteries and may render them unusable even after recharging.
- Ni-MH batteries will self-discharge even when not used, and the time for which they can be used may be shortened as a result.
- Ni-MH batteries will deteriorate rapidly if over-discharged (e.g. by discharging the batteries in a flashlight). Use the “Discharging rechargeable batteries” function provided in the camera to discharge the batteries.

- Ni-MH batteries have a limited service life. If a battery can only be used for a short time even after repeated discharge-charge cycles, it may have reached the end of its service life.

■ Disposing of Batteries

- When disposing of batteries, do so in accordance with your local waste disposal regulations.

3 Notes on both models (1 2)

■ AC Power Adapter

Always use the AC Power Adapter with the camera. The use of an AC Power adapter other than FUJIFILM AC Power Adapter can be damaged to your digital camera.

For details on the AC power adapter, refer to the *Owner’s Manual* of your camera.

- Use the AC power adapter for indoor use only.
- Plug the connection cord plug securely into the DC input terminal.
- Turn off the FUJIFILM Digital camera before disconnecting the cord from the DC input terminal. To disconnect, pull out the plug gently. Do not pull on the cord.
- Do not use the AC power adapter with any device other than your camera.
- During use, the AC power adapter will become hot to the touch. This is normal.

- Do not take apart the AC power adapter. Doing so could be dangerous.
- Do not use the AC power adapter in a hot and humid place.
- Do not subject the AC power adapter to strong shocks.
- The AC power adapter may emit a humming. This is normal.
- If used near a radio, the AC power adapter may cause static. If this happens, move the camera away from the radio.

Before Using the Camera

Do not aim the camera at extremely bright light sources, such as the sun in a cloudless sky. Failure to observe this precaution could damage the camera image sensor.

■ Test Shots Prior to Photography

For important photographs (such as weddings and overseas trips), always take a test shot and view the image to make sure that the camera is working normally.

- FUJIFILM Corporation cannot accept liability for any incidental losses (such as the costs of photography or the loss of income from photography) incurred as a result of faults with this product.

■ Notes on Copyright

Images recorded using your digital camera system cannot be used in ways that infringe copyright laws without the consent of the owner,

unless intended only for personal use. Note that some restrictions apply to the photographing of stage performances, entertainments and exhibits, even when intended purely for personal use. Users are also asked to note that the transfer of Memory Card containing images or data protected under copyright laws is only permissible within the restrictions imposed by those copyright laws.

■ Handling Your Digital Camera

To ensure that images are recorded correctly, do not subject the camera to impact or shock while an image is being recorded.

■ Liquid Crystal

If the LCD monitor is damaged, take particular care with the liquid crystal in the monitor. If any of the following situations arise, take the urgent action indicated.

- If liquid crystal comes in contact with your skin:
Wipe the area with a cloth and then wash thoroughly with soap and running water.
- If liquid crystal gets into your eye:
Flush the affected eye with clean water for at least 15 minutes and then seek medical assistance.
- If liquid crystal is swallowed:
Flush your mouth thoroughly with water. Drink large quantities of water and induce vomiting. Then seek medical assistance.

■ Trademark Information

-  and *xD-Picture Card*™ are trademarks of FUJIFILM Corporation.
- IBM PC/AT is a registered trademark of International Business Machines Corp. of the U.S.A.
- Macintosh, QuickTime, and Mac OS are trademarks of Apple Inc. in the U.S.A. and other countries.
- Windows 7, Windows Vista and the Windows logo are trademarks of the Microsoft group of companies.
- IrSimple™ Trademark is owned by the Infrared Data Association®.
- IrSS™ Trademark or IrSimpleShot™ Trademark is owned by the Infrared Data Association®.
- SDHC logo is a trademark.
- HDMI logo is a trademark.
- YouTube is a trademark of Google Inc.
- Other company or product names are trademarks or registered trademarks of the respective companies.

■ Notes on Electrical Interference

If the camera is to be used in hospitals or aircrafts, please note that this camera may cause interference to other equipment in the hospital or aircraft. For details, please check with the applicable regulations.

■ Explanation of Color Television System

NTSC: National Television System Committee, color television telecasting specifications adopted mainly in the U.S.A., Canada and Japan.

PAL: Phase Alternation by Line, a color television system adopted mainly by European countries and China.

■ Exif Print (Exif ver. 2.3)

Exif Print Format is a newly revised digital camera file format that contains a variety of shooting information for optimal printing.

IMPORTANT NOTICE: Read Before Using the Software

Direct or indirect export, in whole or in part, of licensed software without the permission of the applicable governing bodies is prohibited.

About This Manual

Before using the camera, read this manual and the warnings on pages ii–viii. For information on specific topics, consult the sources below.

✓ **Camera Q & A**pg. x

Know what you want to do but don't know the name for it? Find the answer in "Camera Q & A."

✓ **Troubleshooting**pg. 98

Having a specific problem with the camera? Find the answer here.

✓ **Glossary**pg. 109

The meanings of some technical terms may be found here.

✓ **Table of Contents**pg. xiii

The "Table of Contents" gives an overview of the entire manual. The principal camera operations are listed here.

✓ **Warning Messages and Displays**pg. 105

Find out what's behind that flashing icon or error message in the monitor.

✓ **Restrictions on Camera Settings**.....*Basic Manual*

See the *Basic Manual* for restrictions on the options available in each shooting mode.

Memory Cards

Pictures can be stored in the camera's internal memory or on SD and SDHC memory cards. In this manual, SD memory cards are referred to as "memory cards." For more information, see page 11.

Camera Q & A

Find items by task.







Camera Setup

Question	Key phrase	See page
How do I set the camera clock?	Date and time	15
Can I set the clock to local time when I travel?	Time difference	92
How do I use the touch panel display?	Touch panel display	4
How do I keep the display from turning off automatically?	Auto power off	91
How do I make the display brighter or darker?	LCD brightness	89
How do I stop the camera beeping and clicking?	Volume	89
	Silent mode	21
Can I change the sound the shutter makes?	Sound	89
What do the icons in the display mean?	Displays	3, 6, 7
How much charge is left in the battery?	Battery level	18
How do I calibrate the touch panel?	Calibration	94
Can selected portrait subjects be given priority for focus?	Face recognition	40

Sharing Pictures

Question	Key phrase	See page
Can I print pictures on my home printer?	Printing pictures	62

Taking Pictures

Question	Key phrase	See page
Can the camera automatically adjust settings for different scenes?	 mode	17
Can I choose between clarity, reduced noise, and dynamic range?	 ,  , and  modes ()	23
Can I use the touch panel to take pictures?	Touch and shoot	24
How do I shoot a panorama?	Motion panorama 360	28
How can I avoid blurred pictures?	Dual IS mode	18
How can I make good portraits?	Intelligent Face Detection	30
Can personal information be added to portraits automatically?	Face recognition	40
Can I choose my own settings for different scenes?	SP (scene position)	25
Is there a mode for photographing pet dogs?	 Pet detection (dog) mode	25
Is there a mode for photographing pet cats?	 Pet detection (cat) mode	25
How do I shoot close-ups?	Macro mode (close-ups)	37
How do I keep the flash from firing?	Flash mode	32
How do I stop my subjects' eyes glowing red when I use the flash?		
How do I "fill-in" shadows on back-lit subjects?		
How do I take a series of pictures in a single burst?	Continuous shooting	76
How do I take a group portrait that includes the photographer?	Self-timer mode	34
How do I adjust exposure?	Exposure compensation	72
How do I simulate the effects of different types of film?	Film simulation	75
How do I shoot movies?	Recording movies	59

Viewing Pictures

Question	Key phrase	See page
Can I put a password on my private folder?	Password	80
How do I view my pictures?	Single-frame playback	44
Can I view face recognition information?	Face recognition	42
Can I compare two pictures side by side?	Picture compare	79
How do I delete the current picture?	The  icon	22
Can I select other pictures for deletion?	Deleting pictures	22, 47
Can I zoom in on pictures during playback?	Playback zoom	45
Can I mark images with favorite (★) rating?	★ Favorites	44
How do I view a lot of pictures at once?	Multi-frame playback	46
How do I display pictures in “tall” (portrait) orientation?	Rotating the camera	5
Can I protect my pictures from accidental deletion?	Protect	82
Can I create a collage?	Collage	50
How do I organize my pictures into folders?	Folder management	79
How do I find pictures?	Image search	54
Can I create photobooks from my favorite pictures?	Photobook assist	56
Can I select pictures for upload to YouTube™?	Uploading pictures	84
Can I select pictures for upload to Facebook?		

Table of Contents

For Your Safety	ii
IMPORTANT SAFETY INSTRUCTIONS.....	ii
Safety Notes.....	iv
About This Manual.....	ix
Camera Q & A.....	x

Before You Begin

Introduction.....	1
Symbols and Conventions.....	1
Supplied Accessories.....	1
Parts of the Camera.....	2
Camera Displays (Touch Panel)	3
The Touch Panel Display	4
Rotating the Camera.....	5
Touch Panel Icons	6





















First Steps

Charging the Battery	8
Inserting the Battery.....	9
Inserting a Memory Card	11
Turning the Camera on and Off.....	14
Shooting Mode.....	14
Playback Mode.....	14
Basic Setup	15





Basic Photography and Playback

Taking Pictures in  (EXR AUTO) Mode.....	17
Viewing Pictures.....	22

More on Photography

 Shooting Mode.....	23
 EXR	23
 AUTO.....	24
 TOUCH & SHOOT	24
SP SCENE POSITION	25
 DOG/  CAT	25
 /   NATURAL LIGHT / NATURAL & 	27
 NATURAL LIGHT.....	27
  NATURAL & 	27
 MOTION PANORAMA 360	28
 MANUAL.....	29
 Intelligent Face Detection and Red-Eye Removal ...	30
 Using the Flash (Super-Intelligent Flash)	32
 Using the Self-Timer.....	34
 Macro Mode (Close-ups)	37
Focus Lock	38
 Face Recognition.....	40
Adding New Faces	40
Viewing and Editing Face Recognition Data	42
Adding Faces Automatically	43

More on Playback

Playback Options	44
★ Favorites: Rating Pictures	44
Playback Zoom.....	45
Multi-Frame Playback.....	46
Deleting Pictures	47
Edit	49
 COLLAGE.....	50
 IMAGE ROTATE.....	51
 CROP.....	52
 RESIZE	52
 RED EYE REMOVAL	53
Image Search	54
Image Search: Deleting Pictures	55
Image Search: Folder Management.....	55
Photobook Assist	56
Creating a Photobook	56
Viewing Photobooks	57
Editing and Deleting Photobooks.....	57
Viewing Panoramas	58









Movies

















Recording Movies	59
Viewing Movies	61

Connections

Printing Pictures via USB	62
Connecting the Camera	62
Printing Selected Pictures	63
Viewing Pictures on a Computer	64
Installing the Software.....	64
Connecting the Camera	68

Menus

The Shooting Menu	70
Using the Shooting Menu.....	70
Shooting Menu Options.....	71
 EXP. COMPENSATION	72
 ISO	73
 IMAGE SIZE.....	74
 IMAGE QUALITY	75
 D-RNG DYNAMIC RANGE	75
 FILM SIMULATION	75
 WHITE BALANCE	76
 CONTINUOUS.....	76
 AF MODE.....	77

The Playback Menu	78
Using the Playback Menu	78
Playback Menu Options.....	78
 PICTURE COMPARE	79
 FOLDER MANAGEMENT	79
 SLIDE SHOW	81
 PROTECT	82
 ERASE FACE RECOG.	83
 MARK FOR UPLOAD TO	83
The Setup Menu	85
Using the Setup Menu	85
Setup Menu Options.....	85
 IMAGE DISP	87
 FRAME NO.....	88
 DIGITAL ZOOM	89
 VOLUME	89
 SOUND.....	89
 LCD BRIGHTNESS.....	89
 FORMAT.....	90
 AUTO POWER OFF	91
 TIME DIFFERENCE.....	92
 POWER MANAGEMENT	93
 CALIBRATION	94

Technical Notes

Optional Accessories	95
Accessories from FUJIFILM	96
Caring for the Camera	97

Troubleshooting

Troubleshooting	98
Warning Messages and Displays	105



Appendix

Glossary	109
Internal Memory/Memory Card Capacity	110
Specifications	111

Introduction

Symbols and Conventions

The following symbols are used in this manual:

-  **Caution:** This information should be read before use to ensure correct operation.
-  **Note:** Points to note when using the camera.
-  **Tip:** Additional information that may be helpful when using the camera.

Menus and other text in the camera monitor are shown in bold. In the illustrations in this manual, the monitor display may be simplified for explanatory purposes.

Supplied Accessories

The following items are included with the camera:

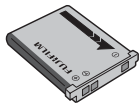

*NP-45A rechargeable
battery*

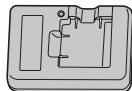

BC-45W battery charger

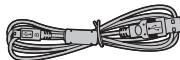

USB cable



CD-ROM

- *Strap*
- *Basic Manual*

Attaching the Strap

Attach the strap as **1** shown.

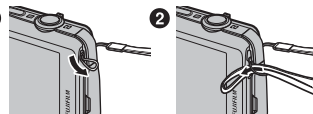

Parts of the Camera

For more information, refer to the page listed to the right of each item.

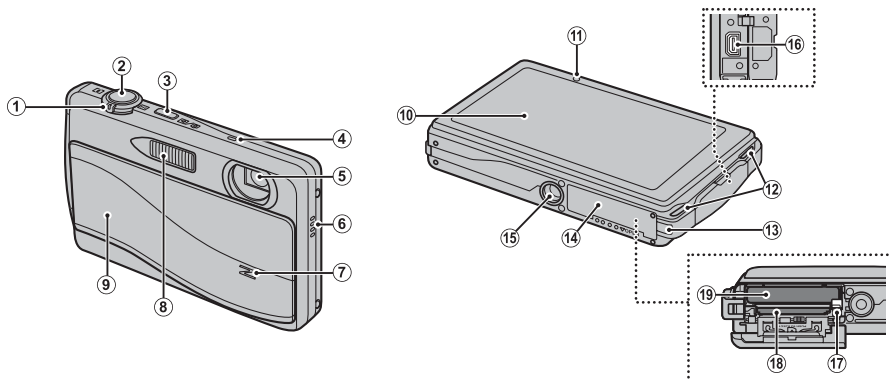

1 Zoom control.....	19, 59	7 Illuminator	85	13 DC coupler cable cover	
2 Shutter button.....	21	Self-timer lamp.....	36	14 Battery-chamber cover	9
3 / button.....	14, 22, 44	8 Flash.....	32	15 Tripod mount	
4 Microphone.....	59	9 On/off switch and lens cover	14	16 USB connector.....	62, 68
5 Lens.....	111	10 Monitor/touch panel display.....	3–7	17 Battery latch	9, 10
6 Speaker	61	11 Indicator lamp.....	20	18 Memory card slot.....	12
		12 Strap eyelet.....	1	19 Battery chamber.....	9

Camera Displays (Touch Panel)

The following indicators may appear during shooting and playback. The indicators displayed vary with camera settings.

■ Shooting

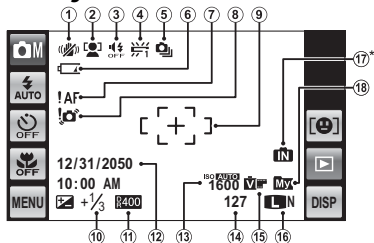

* **IN**: indicates that no memory card is inserted and that pictures will be stored in the camera's internal memory (pg. 11).

1	Dual IS mode	18	10	Exposure compensation	72
2	Intelligent Face Detection indicator	30	11	Dynamic range	75
3	Silent mode indicator	21	12	Date and time	15, 85
4	White balance	76	13	Sensitivity	73
5	Continuous mode	76	14	Number of available frames ..	110
6	Battery level	18	15	Film simulation	75
7	Focus warning	20, 105	16	Image quality and size	74, 75
8	Blur warning	105	17	Internal memory indicator* ..	11
9	Focus frame	38, 77	18	Current folder	79

■ Playback

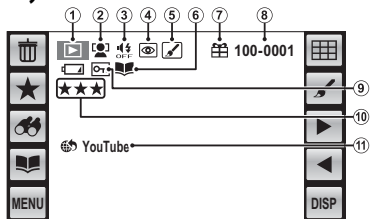

1	Playback mode indicator ...	23, 44	6	Photobook assist indicator ..	56
2	Intelligent Face Detection indicator	30	7	Gift image	44
3	Silent mode indicator	21	8	Frame number	88
4	Red-eye removal indicator	53	9	Protected image	82
5	Edit	49	10	Rating	44
			11	Mark for upload to	83

The Touch Panel Display

The touch panel display can be operated by tapping the display or gliding the stylus or a finger over the panel. The panel responds to pressure; use a firm touch, but do **NOT** use excessive force.

■ **Tap**

Lightly tap the display to adjust settings or select pictures or menu options.

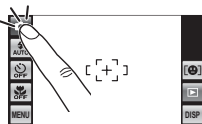

■ **Scroll**

Glide lightly over the display to scroll through pictures during playback.



⚠ **Cautions**

Note that some monitor covers may affect the visibility of the image in the monitor or make the monitor less responsive. To avoid damaging the monitor and touch panel display, observe the following precautions:

- Use only your fingers to operate the panel. Do not use excessive force.
- Do not sit on the camera (by, for example, leaving it in a back pocket when sitting down), place it under heavy objects, or attempt to force it into a small space (such as a suitcase that is already full).
- Do not attach objects to the camera strap that might place pressure on the monitor.

● **The Touch Panel Display**

The actual displays may differ from those shown in this manual.

Rotating the Camera

With some exceptions, the display in the monitor rotates 90° when the camera is in “tall” orientation.

■ Shooting

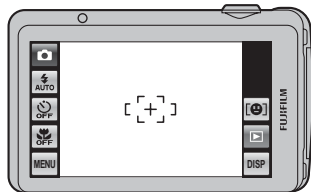

Camera held in “wide”
(landscape) orientation

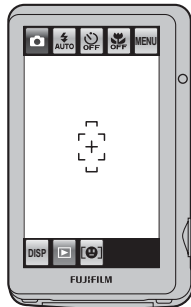

Camera held in “tall”
(portrait) orientation

■ Playback

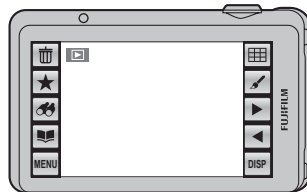

Camera held in “wide”
(landscape) orientation



Camera held in “tall”
(portrait) orientation

Touch Panel Icons

■ Shooting

Tap the icons in the shooting display to perform the operations listed below. The icons displayed vary with the options currently selected.

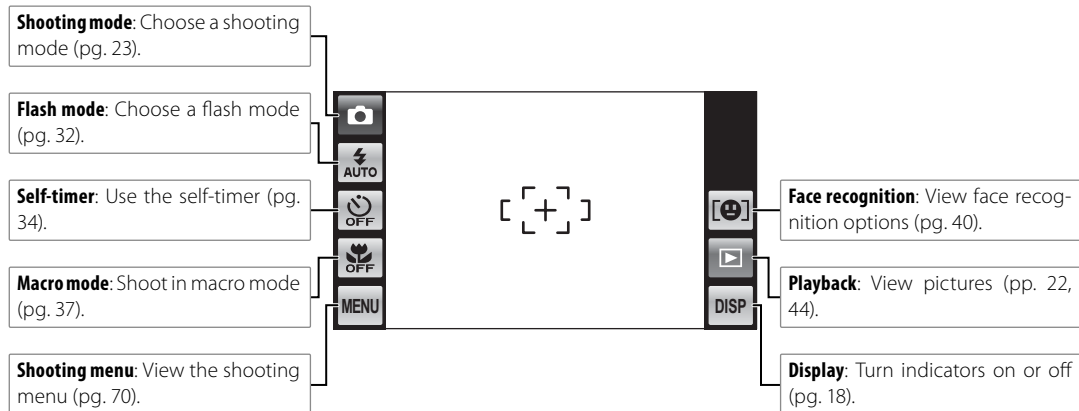

■ Playback

Tap the icons in the playback display to perform the operations listed below. The icons displayed vary with the type of picture and the current playback mode.

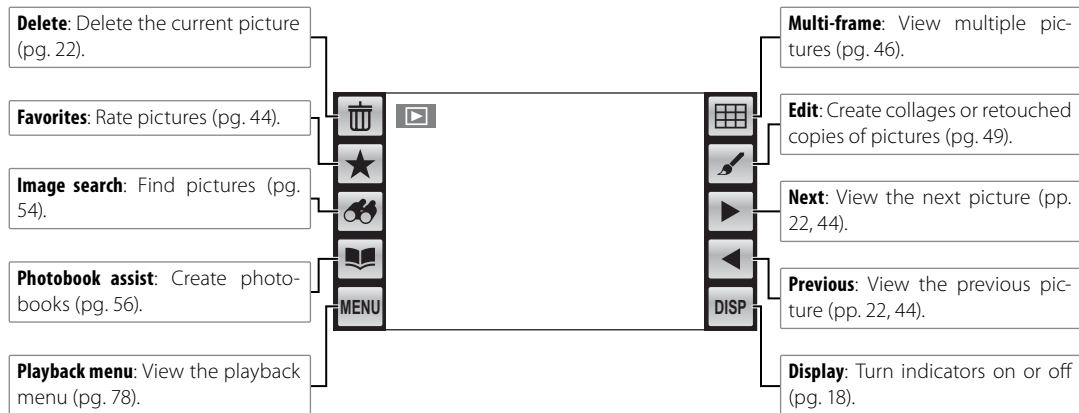

Charging the Battery

The battery is not charged at shipment. Charge the battery before use.

Batteries

The camera uses an NP-45A rechargeable battery.

1 Place the battery in the charger.

Insert the battery into the supplied battery charger as shown, making sure that the battery is in the orientation indicated by the ⊕ ⊖ label.

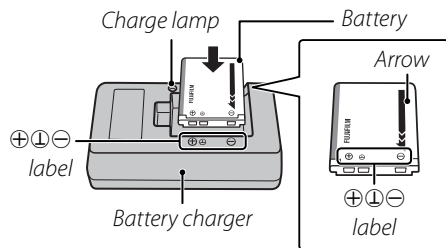

⚠ Cautions

- Unplug the charger when it is not in use.
- Remove dirt from the battery terminals with a clean, dry cloth. Failure to observe this precaution could prevent the battery from charging.
- Charging times increase at low temperatures.

2 Plug the charger in.

Plug the charger into a power outlet. The charging indicator will light.

The Charging Indicator

The charging indicator shows battery charge status as follows:

Charging indicator	Battery status	Action
Off	Battery not inserted.	Insert the battery.
	Battery fully charged.	Remove the battery.
On	Battery charging.	—
Blinks	Battery fault.	Unplug the charger and remove the battery.

3 Charge the battery.

Remove the battery when charging is complete. See page 114 for information on charging times.

Inserting the Battery

After charging the battery, insert it in the camera as described below.

1 Open the battery-chamber cover.

Lightly press the center of the battery-chamber cover and open it as shown.



Note

Be sure the camera is off before opening the battery-chamber cover.

Cautions

- Do not open the battery-chamber cover when the camera is on. Failure to observe this precaution could result in damage to image files or memory cards.
- Do not use excessive force when handling the battery-chamber cover.

2 Insert the battery.

Align the orange stripe on the battery with the orange battery latch and slide the battery into the camera, keeping the battery latch pressed to one side. Confirm that the battery is securely latched.

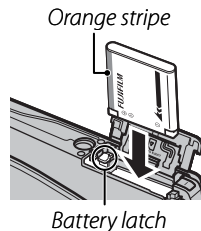

Caution

Insert the battery in the correct orientation. **Do not use force or attempt to insert the battery upside down or backwards.** The battery will slide in easily in the correct orientation.

3 Close the battery-chamber cover.

Close the battery-chamber cover and then lightly press it down and slide it in to latch.



Removing the Battery

After turning the camera off, open the battery-chamber cover, press the battery latch to the side, and slide the battery out of the camera as shown.

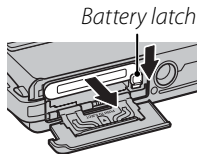

Caution

Turn the camera off before removing the battery.

Cautions

- Do not affix stickers or other objects to the battery. Failure to observe this precaution could make it impossible to remove the battery from the camera.
- Do not short the battery terminals. The battery could overheat.
- Read the cautions on page vi.
- Use only battery chargers designated for use with the battery. Failure to observe this precaution could result in product malfunction.
- Do not remove the labels from the battery or attempt to split or peel the outer casing.
- The battery gradually loses its charge when not in use. Charge the battery one or two days before use.

Tips: Using an AC Power Adapter

- The camera can be powered by an optional AC power adapter and DC coupler (sold separately). See the manuals provided with the AC power adapter and DC coupler for details.
- If the camera is powered by an AC power adapter, demo mode instructions will be displayed when the camera is turned on. Selecting demo mode starts a slide show; to cancel, press the shutter button.

Inserting a Memory Card

Although the camera can store pictures in internal memory, optional SD memory cards (sold separately) can be used to store additional pictures.

When no memory card is inserted, **[M]** appears in the monitor and internal memory is used for recording and playback. Note that because camera malfunction could cause internal memory to become corrupted, the pictures in internal memory should periodically be transferred to a computer and saved on the computer hard disk or on removable media such as CDs or DVDs. The pictures in internal memory can also be copied to a memory card (see page 80). To prevent internal memory from becoming full, be sure to delete pictures when they are no longer needed.

When a memory card is inserted as described below, the card will be used for recording and playback.

■ **Compatible Memory Cards**

FUJIFILM and SanDisk SD and SDHC memory cards have been approved for use in the camera. A complete list of approved memory cards is available at http://www.fujifilm.com/products/digital_cameras/index.html. Operation is not guaranteed with other cards. The camera can not be used with **xD-Picture Cards** or **MultiMediaCard** (MMC) devices.

[!] **Caution**

SD memory cards can be locked, making it impossible to format the card or to record or delete images. Before inserting an SD memory card, slide the write-protect switch to the unlocked position.

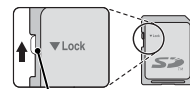

Write-protect switch

■ Inserting a Memory Card

1 Turn the camera off and open the battery-chamber cover.

Lightly press the center of the battery-chamber cover and open it as shown.

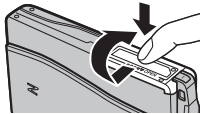

2 Insert the memory card.

Holding the memory card in the orientation shown at right, slide it in until it clicks into place at the back of the slot.

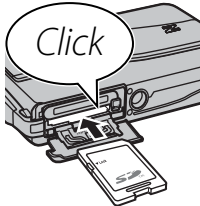

⚠ Caution

Be sure card is in correct orientation; do not insert at an angle or use force. If the memory card is not correctly inserted, pictures will be recorded to internal memory.

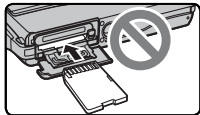

3 Close the battery-chamber cover.

Close the battery-chamber cover and then lightly press it down and slide it in to latch.

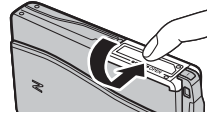

● Removing Memory Cards

Turn the camera off and then press the card in and release it slowly. The card can now be removed by hand.

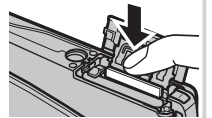

⚠ Cautions

- The memory card may spring out if you remove your finger immediately after pushing the card in.
- Memory cards may be warm to the touch after being removed from the camera. This is normal and does not indicate a malfunction.

Cautions

- **Do not turn the camera off or remove the memory card while the memory card is being formatted or data are being recorded to or deleted from the card.** Failure to observe this precaution could damage the card.
- Format SD memory cards before first use, and be sure to reformat all memory cards after using them in a computer or other device. For more information on formatting memory cards, see page 90.
- Memory cards are small and can be swallowed; keep out of reach of children. If a child swallows a memory card, seek medical assistance immediately.
- miniSD or microSD adapters that are larger or smaller than the standard dimensions of an SD card may not eject normally; if the card does not eject, take the camera to an authorized service representative. Do not forcibly remove the card.
- Do not affix labels to memory cards. Peeling labels can cause camera malfunction.
- Movie recording may be interrupted with some types of SD memory card. Use a card with a class 4 write speed (4 MB/s) or better when shooting HD movies.
- The data in internal memory may be erased or corrupted when the camera is repaired. Please note that the repairer will be able to view pictures in internal memory.
- Formatting a memory card or internal memory in the camera creates a folder in which pictures are stored. Do not rename or delete this folder or use a computer or other device to edit, delete, or rename image files. Always use the camera to delete pictures from memory cards and internal memory; before editing or renaming files, copy them to a computer and edit or rename the copies, not the originals.

Turning the Camera on and Off

Shooting Mode

To turn the camera on, open the lens cover fully. The camera turns off when the lens cover is closed.

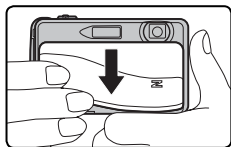

Camera on

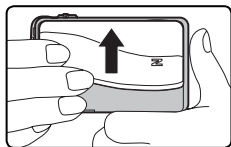

Camera off

Tip: Switching to Playback Mode

Touch the  icon or press the  button to start playback.



Caution

Pictures can be affected by fingerprints and other marks on the lens. Keep the lens clean.

Caution

The indicator lamp lights when the camera is turned off. Do not remove the battery while the lamp is lit. The camera can not be turned on again until the lamp turns off.

Tip: Auto Power Off

The camera will turn off automatically if no operations are performed for the length of time selected in the  **AUTO POWER OFF** menu (pg. 91). To turn the camera on, close and reopen the lens cover or press the  button for about a second.

Playback Mode

If the lens cover is closed, the camera can be turned on in playback mode by pressing the  button for about a second.

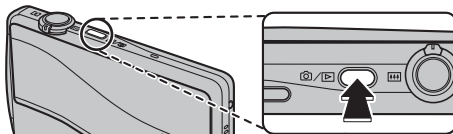

Press the  button for about a second to turn the camera off.

Tip: Switching to Shooting Mode

To exit to shooting mode, press the shutter button or the  button.

Basic Setup

A language-selection dialog is displayed the first time the camera is turned on. Set up the camera as described below (for information on resetting the clock or changing languages, see page 85).

1 Choose a language.

Tap to select a language. Tap ▲ or ▼ to view additional languages.



2 Set the date.

Tap the ▲ or ▼ arrows to set the date and then tap **OK**.

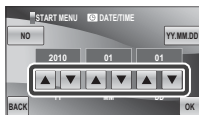

Tip: "NO" and "BACK"

Tap **BACK** to return to the previous step, **NO** to skip the current step. Any steps you skip will be displayed the next time the camera is turned on.

Note

To change the order in which the year, month, and day are displayed, tap **YY.MM.DD**.

3 Set the time.

Select **AM** or **PM**, tap the ▲ or ▼ arrows to set the time, and tap **OK**.

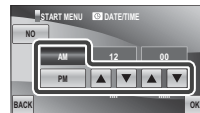

4 Choose a shooting mode.

Tap to select.



5 Choose power management options.

Tap one of the following options:

- **POWER SAVE:** Save battery power.
- **QUICK AF:** Reduce focusing time, ensuring a quick shutter response.
- **CLEAR DISPLAY:** Choose for a brighter, higher quality display.

Tap **OK** to enter shooting mode when setup is complete.

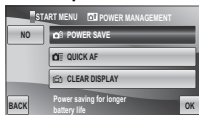

Tip: The Camera Clock

If the battery is removed for an extended period, the camera clock will be reset and the language-selection dialog will be displayed when the camera is turned on. If the battery is left in the camera or an optional AC power adapter connected for about a day, the battery can be removed for about a week without resetting the clock, language selection, shooting mode, or power management options.

5 Check the battery level.

Check the battery level in the display.



Indicator	Description
(white)	Battery partially discharged.
(white)	Battery more than half discharged.
(red)	Low battery. Charge as soon as possible.
(blinks red)	Battery exhausted. Turn camera off and charge battery.

● Hiding and Viewing Indicators

To hide indicators in the display, tap the **DISP** icon. Tap again to display indicators.

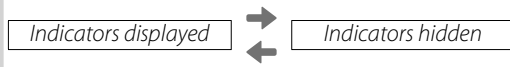

● Avoiding Blurred Pictures

If the subject is poorly lit, blurring caused by camera or subject movement can be reduced by selecting **ON** for **DUAL IS MODE** in the



shooting menu (pg. 71). The type of blur reduction can be selected in the setup menu (pg. 85); is displayed when dual IS is off.

Sensitivity is raised when dual IS is in effect. Note that blurring may still occur depending on the scene. We recommend that you turn dual IS off when using a tripod.

6 Frame the picture.

Use the zoom control to frame the picture in the display.

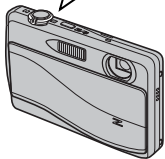
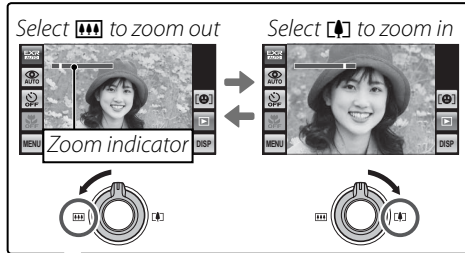

By default, the camera uses optical zoom only. If desired, digital zoom (pg. 89) can be used to zoom in closer.

Tip: Focus Lock

Use focus lock (pg. 38) to focus on subjects that are not in the center of the frame.

Holding the Camera

Hold the camera steady with both hands and brace your elbows against your sides. Shaking or unsteady hands can blur your shots.



To prevent pictures that are out of focus or too dark (underexposed), keep your fingers and other objects away from the lens and flash.

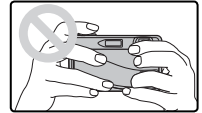

Best Framing

To display a framing guide ("best framing"), select **ON** for the  **FRAMING GUIDELINE** option in the shooting menu (pg. 71).

7 Focus.

Press the shutter button halfway to focus.



⚡ Note

The lens may make a noise when the camera focuses; this is normal. In **EXR** mode, the camera continuously adjusts focus and searches for faces, increasing the drain on the battery.  is displayed in the monitor.

If the camera is able to focus, it will beep twice and the indicator lamp will glow green.

If the camera is unable to focus, the focus frame will turn red, **!AF** will be displayed, and the indicator lamp will blink green. Change the composition or use focus lock (pg. 38).

The Indicator Lamp



The indicator lamp shows camera status as follows:

Indicator lamp	Camera status
Glows green	Focus locked.
Blinks green	Blur, focus, or exposure warning. Picture can be taken.
Blinks green and orange	Recording pictures. Additional pictures can be taken.
Glows orange	Recording pictures. No additional pictures can be taken at this time.
Blinks orange	Flash charging; flash will not fire when picture is taken.
Blinks red	Lens or memory error.

Tip: Warnings

Detailed warnings appear in the display. See pages 105–108 for more information.

8 Shoot.

Smoothly press the shutter button the rest of the way down to take the picture.



← Note

If the subject is poorly lit, the flash may fire when the picture is taken. To take pictures without the flash, choose another flash mode (pg. 32).

📖 Tip: The Shutter Button

The shutter button has two positions. Pressing the shutter button halfway (①) sets focus and exposure; to shoot, press the shutter button the rest of the way down (②).

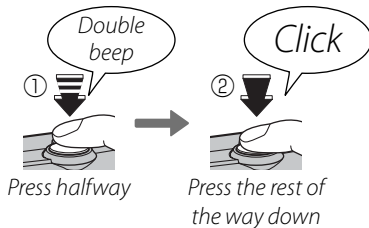

●● Where Are My Pictures Stored?

Pictures will be stored in internal memory if no memory card is inserted. When a memory card is inserted, pictures are stored in the "My" ("my pictures") folder. Use folder management (pg. 79) to organize pictures into other folders after shooting.

●● Silent Mode

In situations in which camera sounds or lights may be unwelcome, select **ON** for **SILENT MODE** in the shooting menu (pg. 71).

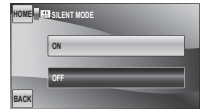

The camera speaker, flash, and illuminator turn off; flash and volume settings (pg. 89) can not be adjusted (note that the flash will still fire in **Ⓝ** mode). To restore normal operation, turn silent mode off.

Viewing Pictures

Pictures can be viewed in the monitor. When taking important photographs, take a test shot and check the results.

1 Tap the icon.



The most recent picture will be displayed.

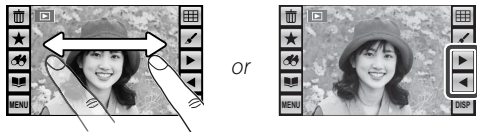

2 View additional pictures.

Scroll left or right or tap  or .



Press the shutter button or / button to exit to shooting mode.

Deleting Pictures

To delete the current picture, tap .



A confirmation dialog will be displayed; tap **OK** to delete the picture or tap **BACK** to exit without deleting the picture.



Tip: The Playback Menu

Pictures can also be deleted from the playback menu (pg. 47).

📷 Shooting Mode

Choose a shooting mode according to the scene or type of subject.

To choose a shooting mode, tap the shooting mode icon in the monitor and tap the icon for the desired mode.

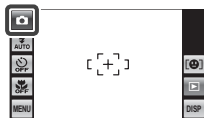

	Mode	See
	EXR	17
	AUTO	24
	TOUCH & SHOOT	24
	SCENE POSITION	25
	MOTION PANORAMA 360	28

	Mode	See
	NATURAL LIGHT / NATURAL & 4	27
	MANUAL	29
	MOVIE	59

A description of the selected mode will be displayed; tap the description to continue, or wait for it to clear from the display automatically.

EXR EXR

This mode can be used to allow the camera to optimize settings for your current subject or to improve clarity, reduce noise, or enhance dynamic range. Selecting this mode displays the following options; select an option and tap **OK**, or tap **BACK** to return to the shooting mode menu.



Option	Description
	EXR AUTO: The camera automatically selects the scene and EXR mode according to shooting conditions (pg. 17).
	RESOLUTION PRIORITY: Choose for crisp, clear shots.
	HIGH ISO & LOW NOISE: Reduce noise in pictures taken at high sensitivities.
	D-RANGE PRIORITY: Increase the amount of detail visible in highlights.

AUTO **AUTO**

Choose for crisp, clear snapshots. This mode is recommended in most situations.

TOUCH & SHOOT

Choose this mode to take pictures by touching the display instead of pressing the shutter button. Touch anywhere inside the “touch and shoot” area to focus on the selected subject and take a picture.



Touch and shoot area





Touch subject to shoot

SP SCENE POSITION

This mode offers a choice of “scenes,” each adapted to particular shooting conditions or a specific type of subject. Select **SP (Scene Position)** in the shooting mode menu (pg. 23) and tap an icon to select a scene. Tap **BACK** to exit.

















DOG/ **CAT**

In these scenes, the camera detects and sets focus for the faces of dogs or cats that are facing the camera, and the self-timer menu offers a  **AUTO RELEASE** option that releases the shutter automatically whenever a pet is detected (pg. 35; to end shooting, tap **STOP**). During playback, image search (pg. 54) can be used to search for pictures taken in either mode and the camera can automatically select the faces of pets for playback zoom (pg. 45), slide shows (pg. 81), and when **ZOOM (CONTINUOUS)** is selected for  **IMAGE DISP.** (pg. 87).

Caution

Although camera can detect many different breeds of dogs and cats, results may vary with the breed and shooting conditions. The camera may fail to detect pets with dark-colored faces or long hair covering their entire face. If a dog or cat is not detected, the camera focuses on the subject at the center of the frame and the  icon is not displayed during playback.

Scene	Description
 PORTRAIT	Choose for soft-toned portraits with natural skin tones.
 PORTRAIT ENHANCER	Choose for soft-focus portraits with a smooth skin effect.
 LANDSCAPE	Choose for crisp, clear daylight shots of buildings and landscapes.
 SPORT	Choose for fast shutter speeds when photographing moving subjects.
 NIGHT	Choose this mode for poorly lit twilight or night scenes. Sensitivity is automatically raised to reduce blur caused by camera shake. Use a tripod to prevent blur.
 NIGHT (TRIPOD)	Choose this mode for slow shutter speeds when shooting at night.
 FIREWORKS	Slow shutter speeds are used to capture the expanding burst of light from a firework. Shutter speed can be selected by tapping the left and right arrows (◀ and ▶). Use a tripod to prevent blur.
 SUNSET	Record the vivid colors in sunrises and sunsets.
 SNOW	Choose for crisp, clear shots that capture the brightness of scenes dominated by shining white snow.
 BEACH	Choose for crisp, clear shots that capture the brightness of sunlit beaches.
 PARTY	Capture indoor background lighting under low-light conditions.
 FLOWER	Choose for vivid close-ups of flowers. The camera focuses in the macro range.
 TEXT	Take clear pictures of text or drawings in print. The camera focuses in the macro range.
 DOG	Choose when photographing dogs. The camera detects and focuses on the faces of dogs.
 CAT	Choose when photographing cats. The camera detects and focuses on the faces of cats.

N/N ⚡ NATURAL LIGHT/NATURAL & ⚡

Selecting this mode displays the options listed in the column at right; tap the desired option, or tap **BACK** to return to the shooting mode menu.

N NATURAL LIGHT

Capture natural light indoors, under low light, or where the flash can not be used. The flash turns off and sensitivity is raised to reduce blur.

N ⚡ NATURAL & ⚡

This mode helps ensure good results with backlit subjects and in other situations with difficult lighting. Each time the shutter button is pressed, the camera takes two shots: one shot without the flash to preserve natural lighting, followed immediately by a second shot with the flash. Do not move the camera until shooting is complete.

Notes

- Do not use where flash photography is prohibited. The flash will fire even in silent mode.
- Only available if memory remains for two pictures.

360°
PANORAMA **MOTION PANORAMA 360**

Follow an on-screen guide to take photos that will automatically be joined to form a panorama.

- 1** Selecting this mode displays panorama options. Tap  and select the pan direction.

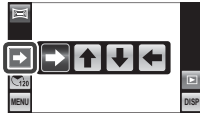

- 2** Tap  and select the angle through which you will pan the camera while shooting.



- 3** Press the shutter button all the way down to start recording. There is no need to keep the shutter button pressed during recording.



Note

The camera zooms all the way out and zoom remains fixed at the widest angle until shooting is complete.

- 4** Pan the camera in the direction shown by the arrow. Shooting ends automatically when the progress bar is full and the panorama is complete.



Caution

Depending on camera settings, the camera may have to be panned through a greater or lesser angle than selected. Shooting may be interrupted if the camera is panned too quickly or too slowly. Panning the camera in a direction other than that shown by the arrow cancels shooting.

Tip

The completed panorama can be viewed on the camera (pg. 58).

⚠ Cautions

- Panoramas are created from multiple frames. The camera may in some cases be unable to stitch the frames together perfectly.
- The desired results may not be achieved with moving subjects, subjects close to the camera, unvarying subjects such as the sky or a field of grass, subjects that are in constant motion, such as waves and waterfalls, or subjects that undergo marked changes in brightness. Panoramas may be blurred if the subject is poorly lit.

●● For Best Results

For best results, move the camera in a small circle at a steady speed, keeping the camera horizontal and being careful only to pan in the direction shown by the guides. If the desired results are not achieved, try panning at a different speed.

●● Printing Panoramas

Depending on the page size and the size of the panorama, panoramas may print with their edges cropped out or with wide margins at the top and bottom or at both sides.

M MANUAL

Choose for complete control of camera settings.

Intelligent Face Detection and Red-Eye Removal

Intelligent Face Detection automatically detects human faces anywhere in the frame and sets focus and exposure for shots that emphasize portrait subjects. Choose to prevent the camera from focusing on the background when taking group portraits, or to remove “red-eye” caused by the flash.



1 Turn Intelligent Face Detection on.

Tap **MENU** to display the shooting menu and tap  (**Face Detec.**).

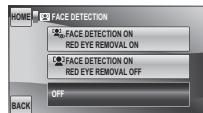

The options shown at right will be displayed. Tap to select.



Option	Description
	Intelligent Face Detection and red-eye removal on. Use with the flash.
	Intelligent Face Detection on; red-eye removal off.
OFF	Intelligent Face Detection and red-eye removal off.

2 Frame the picture.

Frame the picture in vertical or horizontal orientation. If a face is detected, it will be indicated by a green border. If there is more than one face in the frame, the camera will select the face closest to the center; other faces are indicated by white borders.



Green border

3 Focus.

Press the shutter button halfway to set focus and exposure for the subject in the green border.



Caution

In some modes, the camera may set exposure for the frame as a whole rather than the portrait subject. If no face is detected when the shutter button is pressed halfway (pg. 100), the camera will focus on the subject at the center of the display and red-eye will not be removed.

4 Shoot.

Press the shutter button all the way down to shoot.



Caution

If the subject moves as the shutter button is pressed, their face may not be in the area indicated by the green border when the picture is taken.

If  **FACE DETECTION ON** and **RED EYE REMOVAL ON** is selected, the picture will be processed to reduce red-eye before it is recorded.

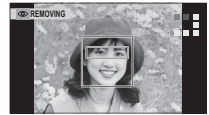

Intelligent Face Detection

Intelligent Face Detection is recommended when using the self-timer for group- or self-portraits (pg. 34).



When setting focus and exposure, the camera gives priority to subjects in its face recognition database (pg. 40), and subjects identified in this manner can later be located using image search (pg. 54). When a picture taken with Intelligent Face Detection is displayed, the camera can automatically select faces for playback zoom (pg. 45), red-eye removal (pg. 53), slide shows (pg. 81), and when **ZOOM (CONTINUOUS)** is selected for  **IMAGE DISP.** (pg. 87).





⚡ Using the Flash (Super-Intelligent Flash)

When the flash is used, the camera's *Super-Intelligent Flash* system instantly analyzes the scene based on such factors as the brightness of the subject, its position in the frame, and its distance from the camera. Flash output and sensitivity are adjusted to ensure that the main subject is correctly exposed while preserving the effects of ambient background lighting, even in dimly-lit indoor scenes. Use the flash when lighting is poor, for example when shooting at night or indoors under low light.



1 Choose a flash mode.

Tap the flash mode icon to display a menu of flash modes and tap to select the desired mode (depending on camera settings, some modes may not be available; see page 21 of the *Basic Manual*).



Option	Description
 (AUTO FLASH)	The flash fires when required. Recommended in most situations.
 (FORCED FLASH)	The flash fires whenever a picture is taken. Use for backlit subjects or for natural coloration when shooting in bright light.
 (SUPPRESSED FLASH)	The flash does not fire even when the subject is poorly lit. Use of a tripod is recommended.
 (SLOW SYNCHRO)	Capture both the main subject and the background under low light (note that brightly lit scenes may be overexposed).

2 Focus.

Press the shutter button halfway to focus. If the flash will fire,  will be displayed when the shutter button is pressed halfway. At slow shutter speeds,  will appear in the display to warn that pictures may be blurred; use of a tripod is recommended.



⚡ Note

When using the flash to take pictures in “tall” (portrait) orientation, we recommend that you hold the camera with the flash above the lens.

3 Shoot.





Press the shutter button the rest of the way down to shoot.

⚠ Caution

The flash may fire several times with each shot. Do not move the camera until shooting is complete.



●● Red-Eye Removal

When  **FACE DETECTION ON RED EYE REMOVAL ON** is selected for Intelligent Face Detection (pg. 30), red-eye removal () is available in RED EYE REDUCTION () , FORCED FLASH () , and RED EYE & SLOW () modes. Red-eye removal minimizes “red-eye” caused when light from the flash is reflected from the subject’s retinas as shown in the illustration at right.



🕒 Using the Self-Timer

The camera offers a “couple timer” for self-portraits taken with a friend, a “group timer” for group portraits, an “auto release timer” for baby portraits, a ten-second timer (pg. 36) that allows photographers to appear in their own photographs, and a two-second timer (pg. 36) that can be used to avoid blur caused by the camera moving when the shutter button is pressed.

Tap the self-timer icon to display self-timer options and tap to select.

Option	Description
👶 (AUTO RELEASE)	For pictures of babies (pg. 35).
👫 (COUPLE TIMER)	For self-portraits taken with a friend (pg. 35).
👥 (GROUP TIMER)	For group portraits (pg. 35).
🕒 (10 SEC)	Ten-second timer (pg. 36).
🕒 (2 SEC)	Two-second timer (pg. 36).
🕒 (OFF)	Self-timer off.



👉 Note

Turn macro mode on when shooting self-portraits with the camera held at arm's length.

■ **AUTO RELEASE**



The shutter is released automatically whenever the camera detects a human portrait subject facing the camera. Tap **STOP** to end shooting. Use for portraits of babies.



Auto Release

Pictures taken with the auto release timer can be displayed using image search (pg. 54). When a picture taken with the auto release timer is displayed, the camera can automatically select faces for red-eye removal (pg. 53), playback zoom (pg. 45), slide shows (pg. 81), cropping (pg. 52), and when **ZOOM (CONTINUOUS)** is selected for  **IMAGE DISP.** (pg. 87).

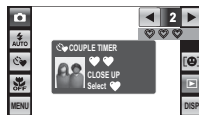

■ **COUPLE TIMER**

The camera will start the timer when it detects two portrait subjects close together. Tap  or  to choose how close the subjects must be together before the timer starts. To stop the timer before the picture is taken, press the shutter button halfway.



Choose **1** (♥; 2 s timer), **2** (♥♥; 2 s timer), or **3** (♥♥♥; 1 s timer).
The more hearts, the closer the subjects must be together.

■ **GROUP TIMER**

The camera will start the timer when it detects the selected number of portrait subjects. Tap  or  to choose the number of subjects. To stop the timer before the picture is taken, press the shutter button halfway.



Choose the number of subjects from 1–4. Timer duration is 1 s for single subjects, 2 s for groups of two or more.

■ (10 SEC) / (2 SEC)

The camera will start the timer ten or two seconds after the shutter button is pressed all the way down.

1 Focus.

Press the shutter button halfway to focus.

Caution

Stand behind the camera when using the shutter button. Standing in front of the lens can interfere with focus and exposure.



2 Start the timer.

Press the shutter button the rest of the way down to start the timer. The display in the monitor shows the number of seconds remaining until the shutter is released.



The self-timer lamp on the front of the camera will blink immediately before the picture is taken. If the two-second timer is selected, the self-timer lamp will blink as the timer counts down.

Intelligent Face Detection

Because it ensures that the faces of portrait subjects will be in focus, Intelligent Face Detection (pg. 30) is recommended when using the self-timer for group portraits or self-portraits. To use the self-timer with Intelligent Face Detection, turn Intelligent Face Detection on, set the timer as described in Step 1, and then press the shutter button all the way down to start the timer. The camera will detect faces while the timer is counting down and adjust focus and exposure immediately before the shutter is released.

🌿 Macro Mode (Close-ups)

Use macro mode for close-ups. To turn macro mode on, tap the macro mode icon (①) and tap 🌿 (②).

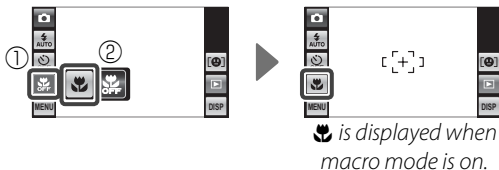

When macro mode is in effect, the camera focuses on subjects near the center of the frame. Use the zoom control to compose pictures.

👉 Note

Use of a tripod is recommended to prevent blur caused by camera shake.

Focus Lock

To compose photographs with off-center subjects:

1 Position the subject in the focus frame.



2 Focus.

Press the shutter button halfway to set focus and exposure. Focus and exposure will remain locked while the shutter button is pressed halfway (AF/AE lock).



*Press
halfway*



Repeat steps 1 and 2 as desired to refocus before taking the picture.

3 Recompose the picture.

Keeping the shutter button pressed halfway, recompose the picture.



4 Shoot.

Press the shutter-release button the rest of the way down to take the picture.



*Press the rest of
the way down*

Autofocus

Although the camera boasts a high-precision autofocus system, it may be unable to focus on the subjects listed below. If the camera is unable to focus using autofocus, use focus lock (pg. 38) to focus on another subject at the same distance and then recompose the photograph.

- Very shiny subjects such as mirrors or car bodies.



- Fast-moving subjects.

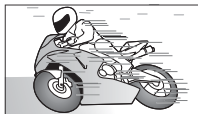

- Subjects photographed through a window or other reflective object.
- Dark subjects and subjects that absorb rather than reflect light, such as hair or fur.
- Insubstantial subjects, such as smoke or flame.
- Subjects that show little contrast with the background (for example, subjects in clothing that is the same color as the background).

- Subjects positioned in front of or behind a high-contrast object that is also in the focus frame (for example, a subject photographed against a backdrop of highly contrasting elements).
- Subjects positioned at some distance in front of or behind an object that is also in the focus frame (for example, a subject in a cage, where the both the subject and the bars of the cage are in the focus frame).
- Subjects dominated by regular geometric patterns, such as the windows in an office building.
- Subjects that contain many fine details, such as a field of flowers or other subjects that are small or lack variation in brightness.

Hybrid Autofocus

The camera's hybrid autofocus system ensures fast focus, particularly when a bright, high-contrast subject is positioned in the center of the frame.

[⊕] Face Recognition

The camera can store information on the face and personal details (name, relationship, and birth date) of portrait subjects and assign these subjects priority for Intelligent Face Detection (pg. 30) or display their names and other information during playback (pg. 44).

Adding New Faces

Follow the steps below to add faces to the face recognition database.

1 Select **REGISTER**.

Tap [⊕] to display face recognition options and tap **REGISTER**.



Note

To disable face recognition, select **OFF** for **FACE RECOGNITION**.

2 Take a photograph.

With the subject facing the camera, use the guides to frame the face of the person you wish to add to the face recognition database and take a picture. A confirmation dialog will be displayed; tap **REGISTER** to add the face to the database, **RETRY** to try again (if an error is displayed, tap **BACK** and try again).



3 Enter a name, relationship, and birth date.

The following options will be displayed:

- **NAME:** Enter a name as described under “Text Entry,” below.
- **CATEGORY:** Tap the option that describes your relationship to the subject.
- **BIRTHDAY:** Tap the ▲ and ▼ arrows to enter the subject’s date of birth, then tap **OK**.

← Note

If you zoom in on the face of a person in the face recognition database on their birthday, the camera will display their name and the message “Happy Birthday!”

4 Tap OK.

After confirming that the information you have entered is correct, tap **OK** to return to the face recognition menu.

Text Entry

- 1 Tap the text entry mode button until the desired text entry mode (uppercase letters, symbols, or numbers) is displayed.



Mode button

- 2 To enter a character, tap the desired button one or more times (for example, tap the **PQRS** button once to enter “P”, three times to enter “R”).
- 3 To proceed to the next character, tap ►. To delete an existing character, tap ◀ or ▶ to highlight the character and tap **DEL**. Names may be up to 14 characters long.
- 4 Tap **OK** when text entry is complete.

Viewing and Editing Face Recognition Data

Follow the steps below to view, edit, or delete face recognition data.

1 Select **VIEW & EDIT**.

Tap [😊] to display face recognition options and tap **VIEW & EDIT**.



2 Select a face.

The faces in the database will be displayed as shown at right; tap a face to display face recognition data for the selected subject.



3 View or edit face recognition data.

To modify the name, category, or birth date, tap the current entry and edit the data as described in Step 3 on page 41. To retake the photo, tap **REPLACING IMAGE** and shoot a new portrait as described in Step 2 on page 40.

Tap **BACK** to exit when you have finished viewing or editing the face recognition data. To delete face recognition data for the selected subject, tap [🗑️].

Adding Faces Automatically

To automatically add frequently-photographed subjects to the face recognition database, select **ON** for **AUTO REGISTRATION** in the face recognition menu. If the camera detects a face that has been photographed many times without being added to the database, it will display a message prompting you to create a new face recognition entry. Tap **OK** and enter face recognition data as described in Step 3 on page 41.

👉 Note

The camera may sometimes fail to recognize new faces automatically. If necessary, faces can be added manually using the **REGISTER** option as described on pages 40–41.

🔴 Face Recognition



The camera can store data on up to eight faces. If you attempt to add a ninth face, a confirmation dialog will be displayed; use the **VIEW & EDIT** option to make room for new faces by deleting existing data. **AUTO REGISTRATION** is disabled if there are already data for eight faces.

When Intelligent Face Detection (pg. 30) is on and the frame contains multiple subjects from the face recognition database, the camera displays the name of the subject that will be used to set focus and exposure (the subject shown by the green frame). If no name is entered, the camera will show “---”. Subjects identified using face recognition but not used to set focus and exposure are shown by orange frames, other subjects by white frames.

⚠ Caution

Face recognition may not function as expected if the subject is not facing the camera, if only part of the subject’s face is in the frame, or if details of the subject’s face or expression differ markedly from those recorded in the database.

Playback Options

To view the most recent picture, tap the  icon in the monitor or press the  button.

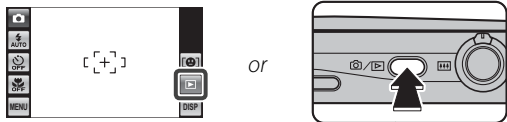

Scroll left or right or tap  or  to view additional pictures.

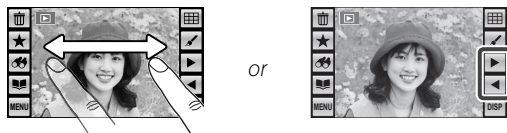

Hiding Indicators

Tap **DISP** to hide or view indicators.

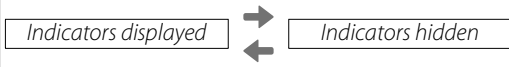

Note

Pictures taken using other cameras are indicated by a  ("gift image") icon.

★ **Favorites: Rating Pictures**

To rate the picture currently displayed in full-frame playback, tap . A ratings dialog will be displayed; tap to select a rating of from zero to five stars.











Tips: Favorites

- Ratings can be used for image search (pg. 54).
- Pictures can also be rated in the playback menu (pg. 78).

Playback Zoom

To zoom a picture in or out:

- 1 Display the picture full screen and tap the picture to display the  icon.
- 2 Tap the  icon. Zoom controls will be displayed; tap  to zoom in or  to zoom out (you can also select  with the camera zoom control to display the zoom slider and use the zoom control to zoom in and out, or tap the display to zoom in on the selected area). Tap , , , or  to scroll the display.



Tap **BACK** to exit zoom.

Note

The maximum zoom ratio varies with image size.







Intelligent Face Detection/Pet Detection

Pictures taken with Intelligent Face Detection (pg. 30) or the auto release timer (pg. 35) are indicated by a  icon, pictures taken with pet detection (pg. 25) by a  icon. Tap the icon to zoom in on a subject the camera has detected. You can then use the  icon or zoom control to zoom in and out.



Multi-Frame Playback

To view pictures nine at a time, tap  in single-frame view. The number of pictures displayed changes each time you tap  (you can also select  with the camera zoom control to increase the number of pictures displayed or  to decrease the number of pictures).

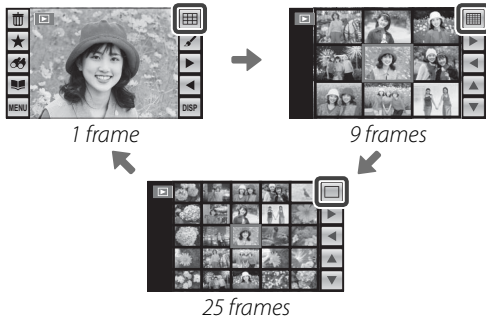

In 9- and 25-frame views, scroll left or right or tap , , , or  to view more pictures.

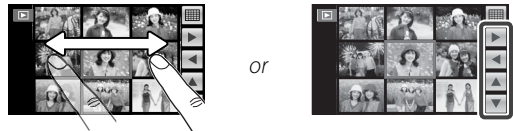





Tap a picture to view it full screen.

← Note

When you tap a picture to display it full screen, the folder containing the selected picture becomes the current folder (pg. 79).

●● Rotating the Camera

When the camera is held in “tall” (portrait) orientation, the highlighted picture appears at the top of the display. Tap , , , or  to highlight pictures and tap the picture at the top of the display to view it full screen.



🗑️ Deleting Pictures

The 🗑️ (**Erase**) option in the playback menu can be used to delete still pictures and movies, increasing the amount of space available on the memory card or in internal memory (for information on deleting pictures in single-frame playback, see page 22). *Note that deleted pictures can not be recovered. Copy important pictures to a computer or other storage device before proceeding.*

1 Tap **MENU** during playback to display the playback menu and tap 🗑️ (**Erase**).



2 Tap **FRAME** or **ALL FRAMES** to display options for the selected item (pg. 48).

📌 Tips: Deleting Pictures

- When a memory card is inserted, pictures will be deleted from the memory card; otherwise, pictures will be deleted from internal memory.
- Protected pictures can not be deleted. Remove protection from any pictures you wish to delete (pg. 82).

■ **FRAME: Deleting Selected Images**

Selecting **FRAME** displays a picture selection dialog. Tap ◀ or ▶ to display a picture you wish to delete and tap .

A confirmation dialog will be displayed; tap **OK** to delete the current picture and return to the picture-selection dialog. To continue without deleting the picture, tap **BACK**.

Tap **BACK** to exit when all the desired pictures have been deleted.



■ **ALL FRAMES: Deleting All Images in a Folder**

Selecting **ALL FRAMES** displays a confirmation dialog. Tap **OK** to delete all unprotected pictures in the current folder (pg. 79).

The dialog shown at right is displayed during deletion. Tap **BACK** to cancel before all pictures have been deleted (any pictures deleted before **BACK** was selected can not be recovered).

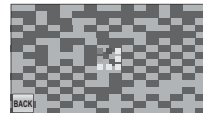





Edit

To rotate pictures, make collages, or create cropped or resized copies of pictures, tap the  icon in single-frame view.

Tap  or  to scroll through the menu and tap an option to select it.



Option	Description
 COLLAGE	Create collages (pg. 50).
 IMAGE ROTATE	Rotate pictures (pg. 51).
 CROP	Create cropped copies of pictures (pg. 52).
 RESIZE	Create small copies of pictures (pg. 52).
 RED EYE REMOVAL	Create copies with reduced red eye (pg. 53).

Tip



Edit options can also be accessed from the playback menu (pg. 78).

COLLAGE

Selecting  **COLLAGE** displays the dialog shown in Step 1.

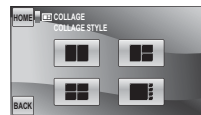





1 Tap the desired template for the collage.



2 Tap a frame in the template and then tap a picture at the right side of the display to place it in the selected frame (you can also select a picture first and then tap the target frame). Repeat until the template is filled. If the desired picture is not visible at the right side of the display, tap  or  to view more pictures.



Tip

To rotate or crop an image for display in a collage, tap its frame in the collage template. Rotation and crop tools will appear at the edges of the display. To rotate the picture, tap . The picture is rotated 90° clockwise each time you tap the icon. Tap  or  to zoom the selected picture in or out and tap , , , or  to position it in the frame. Tap **OK** when the operation is complete. Note that depending on the template, you may not be able to rotate or crop the image.



3 Tap **OK** to complete the collage (to exit without creating a collage, tap **BACK**).

4 Image size options will be displayed. Tap an option to create a collage at the selected size and save it as a new file.

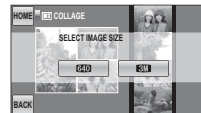

IMAGE ROTATE

This option creates rotated copies of pictures for display in the monitor. It has no effect on pictures displayed on a computer or other device.

- 1 Tap the left and right arrows (◀ and ▶) to select the picture you wish to rotate.
- 2 Tap ↻ to rotate the picture 90° clockwise, ↺ to rotate it 90° counterclockwise.
- 3 Tap **OK** to create the rotated copy (to exit without rotating the picture, tap **BACK**).

The next time the picture is played back, the rotated copy will be displayed.



👉 Note

The camera may not be able to rotate pictures created with other devices.

CROP

Create cropped copies of pictures.

1 Tap the left and right arrows (◀ and ▶) to select the picture you wish to crop.

2 Tap  or  to zoom in and out (tap the picture to re-display the zoom icons as needed, or tap the display to zoom in on a selected area) and tap ▲, ▼, ◀, or ▶ to scroll the picture until the desired portion is displayed. Higher zoom ratios produce smaller copies.

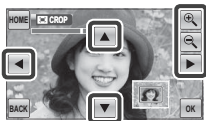

3 Tap **OK** to save the cropped copy to a separate file, **BACK** to exit without cropping.

← Note

Pictures taken with other cameras can not be cropped.

RESIZE

Create small copies of pictures.

1 Tap the left and right arrows (◀ and ▶) to select the picture you wish to resize.

2 Tap an icon to copy the picture at the selected size (to exit without creating a small copy, tap **BACK**). The sizes available vary with the size of the original image:

Size of original image	Available sizes
L	M , S , and 640
M	S and 640
S	640

RED EYE REMOVAL

This option is used with pictures taken using Intelligent Face Detection to create copies that have been processed to remove red eye.

- 1 Tap the left and right arrows (◀ and ▶) to select a picture.
- 2 Tap **OK**. The message shown below at left will be displayed while the camera analyses the image (to exit without creating a copy, tap **STOP**); if red-eye is detected, the message shown below at right will be displayed while the camera processes the image to create a copy with reduced red-eye.



Notes



- Red eye may not be removed if the camera is unable to detect a face or the face is in profile. Results may differ depending on the scene. Red eye can not be removed from pictures that have already been processed using red-eye removal or pictures created with other devices.
- The amount of time needed to process the image varies with the number of faces detected.
- Copies created with  **RED EYE REMOVAL** are indicated by a  icon during playback.

Image Search

Search for pictures by date, subject, scene, and file type.

- 1 Tap the  icon in single-frame view.



- 2 Choose from the following options:



Option	Description
BY DATE	Find all pictures taken on a selected date.
BY FACE	Search for pictures containing a selected person from the face recognition database.
BY ★ FAVORITES	Find all pictures with a specified rating (pg. 44).
BY SCENE	Find all pictures that match a selected scene.
BY TYPE OF DATA	Find all still pictures or all movies.
BY UPLOAD MARK	Find all pictures selected for upload to a specified destination (pg. 83).

Tip

Searches can also be performed from the playback menu (pg. 78).

← Note: “BACK”





Tap **BACK** at any time to return to the previous display.

- 3 Select search conditions to view all matching pictures in the current folder (pg. 79; tap  or  to view additional search conditions). Page through pictures by scrolling the thumbnails left or right.

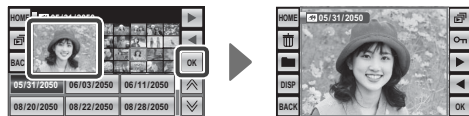

- 4 The large preview to the left of the thumbnails is the current picture. To view the current picture full frame, tap the preview or tap **OK**.



Tap  to protect the current picture. Tap  or  to view other pictures or tap  to view the search results in a slide show.

- 5 To exit, tap **OK** when the current picture is shown full frame. Tap **OK** to end the search, **BACK** to return to Step 4.



Image Search: Deleting Pictures

To delete pictures, tap the  icon when the current picture is shown full frame (pg. 54). Tap **FRAME** to delete the current picture, **ALL FRAMES** to delete all pictures that match the current search conditions (to exit without deleting pictures, tap **BACK**) (pg. 48).

Image Search: Folder Management

To copy or move the pictures, tap the  icon when the current picture is shown full frame (pg. 54) and follow the steps below.

- 1 Tap ◀ or ▶ to display the desired picture.
- 2 Tap the destination folder (pg. 79).



- 3 Tap **MOVE** or **COPY**.

Caution

Copying ends when the destination is full.

Photobook Assist

Create books from your favorite photos.

Creating a Photobook

- 1 Tap the  icon in single-frame view.

Tip

Photobook assist can also be accessed from the playback menu (pg. 78).





- 2 Tap **NEW BOOK**.

- 3 Tap one of the following to choose pictures for the new book.

- **SELECT FROM ALL:** Choose from all pictures in the current folder.
- **SELECT BY IMAGE SEARCH:** Choose from pictures matching selected search conditions (pg. 54).

Note

Neither photographs  or smaller nor movies can be selected for photobooks.

- 4 Scroll through the images and tap  to select or deselect the current image for inclusion in the book. To display the current image on the cover, tap .

Note

The first picture selected automatically becomes the cover image. Tap  to select a different picture for the cover.

- 5 Tap **MENU** to exit when the book is complete.

- 6 Tap **COMPLETE PHOTOBOOK** to add the new book to the list in the photobook assist menu.



Note

Tap **SELECT ALL** to select all images in the current folder or that match the current search conditions.

Cautions

- Photobooks can contain up to 300 pictures.
- Books that contain no photos are automatically deleted.

Viewing Photobooks

To view a book, tap it in the photobook assist menu and then tap ◀ and ▶ to scroll through the pictures.

Editing and Deleting Photobooks

- 1** Display the photobook and tap **MENU**.
- 2** Choose from the following options:
 - **EDIT:** Edit the book as described in “Creating a Photobook” on page 56.
 - **ERASE:** Delete the current photobook.
- 3** Follow the on-screen instructions.

Photobooks

Photobooks can be copied to a computer using the supplied MyFinePix Studio software.

Viewing Panoramas

To view a panorama, display in single-frame view and tap .

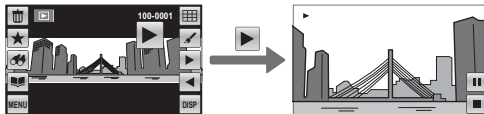

Horizontal panoramas are displayed from left to right, vertical panoramas from bottom to top. The following operations can be performed during playback:

Operation	Description
End playback	Tap  to end playback.
Pause playback	Tap  to pause playback. Tap  to resume.



Recording Movies

Shoot short movies in Motion JPEG format. Sound is recorded via the built in microphone; do not cover the microphone during the recording.

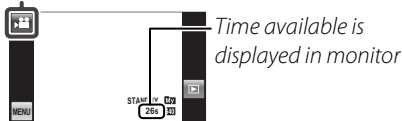

- 1 Tap the shooting mode icon to view a menu of shooting modes and tap  (**Movie**). The camera will enter movie mode.

 *mode icon*



- 2 Tap **MENU** and select a frame size from the  **QUALITY** menu. Tap  (1280×720 pixels) to film in HD or  (640×480 pixels) for longer movies.



If desired, you can also turn  **DUAL IS MODE** (pg. 18),  **SILENT MODE** (pg. 21), and  **FACE DETECTION** (pg. 30) on or off before shooting movies. Red-eye removal is not available.

- 3 Frame the scene using the zoom control.

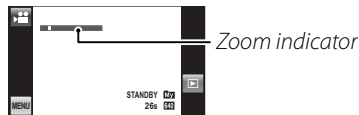

Zoom can not be adjusted once recording begins.

- 4** Press the shutter button all the way down to start recording.

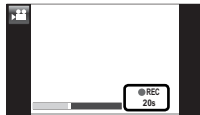

● **REC** and time remaining are displayed in monitor



Notes

- Focus is fixed at the position selected when recording begins, but exposure and white balance are adjusted automatically throughout recording. The color and brightness of the image may vary from that displayed before recording begins.
- Sounds made by the camera may be recorded with the movie.

Tip

If Intelligent Face Detection is on, the camera will automatically detect, focus on, and set exposure for human faces.

- 5** Press the shutter button all the way down to end recording. Recording ends automatically when the movie reaches maximum length or memory is full.



Tip

There is no need to keep the shutter button pressed during recording.

Cautions

- The indicator lamp lights while movies are being recorded. Do not remove the memory card during shooting or while the indicator lamp is lit. Failure to observe this precaution could prevent the movie from being played back.
- Vertical or horizontal streaks may appear in movies containing very bright subjects. This is normal and does not indicate a malfunction.

▶ Viewing Movies

To view a movie, display it in playback mode and follow the steps below.

1 Tap the movie to display it full screen.

2 Tap ▶ to start playback.

Progress is shown in the monitor during playback. The following operations can be performed while playback is in progress:

Operation	Description
End playback	Tap ■ to end playback.
Pause playback	Tap to pause playback. Tap ▶ to resume.

Playback ends automatically when the entire movie has been played.

⚠ Caution

Do not cover the speaker during playback.



Progress bar

Printing Pictures via USB

If the printer supports PictBridge, the camera can be connected directly to the printer and pictures can be printed without first being copied to a computer. Note that depending on the printer, not all the functions described below may be supported.



Connecting the Camera

- 1 Connect the supplied USB cable as shown and turn the printer on.

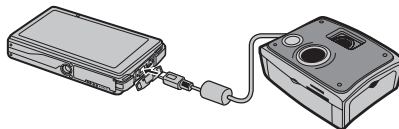

- 2 Press the button for about a second to turn the camera on. **USB** will be displayed in the monitor, followed by the PictBridge display shown below at right.

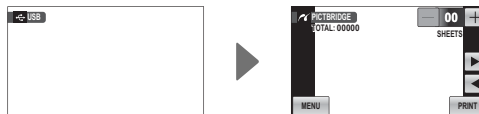

Printing Selected Pictures

- 1 Tap ◀ or ▶ to select a picture you wish to print.
- 2 Tap + or – to choose the number of copies (up to 99).
- 3 Repeat steps 1–2 to select additional pictures. Tap **PRINT** to display a confirmation dialog when settings are complete.

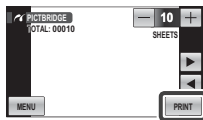

Note

If no pictures are selected when you tap **PRINT**, the camera will print one copy of the current picture.

- 4 Tap **OK** to start printing. To end printing before all pictures have printed, tap **CANCEL**.

Tip: Printing the Date of Recording

To print the date of recording on pictures, tap **MENU** in steps 1–2 to display the PictBridge menu (see below) and select **PRINT WITH DATE**. To ensure that the date is correct, set the camera clock before taking pictures.

- **PRINT WITH DATE**: Print date of recording on pictures.
- **PRINT WITHOUT DATE**: Print pictures without date.

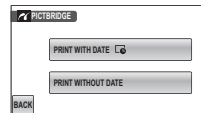

Viewing Pictures on a Computer

The supplied software can be used to copy pictures to a computer, where they can be stored, viewed, organized, and printed. Before proceeding, install the software as described below. **Do not connect the camera to the computer until installation is complete.**

Installing the Software

Two applications are supplied: MyFinePix Studio for Windows and FinePixViewer for the Macintosh. Installation instructions for Windows are on pages 64–65, those for the Macintosh on pages 66–67.

Windows: Installing MyFinePix Studio

1 Confirm that the computer meets the following system requirements:

	Windows 7*	Windows Vista*	Windows XP*
CPU	3 GHz Pentium 4 or better		2 GHz Pentium 4 or better
RAM	1 GB or more		512 MB or more
Free disk space	15 GB or more		2 GB or more
Video	<ul style="list-style-type: none">• 1024 × 768 pixels or more with 24-bit color or better• A graphics processing unit (GPU) that supports DirectX 7 or later		
Other	<ul style="list-style-type: none">• Built-in USB port recommended. Operation is not guaranteed with other USB ports.• Internet connection (broadband recommended) required to install .NET Framework (if necessary), to use auto update feature, and when performing such tasks as sharing pictures on-line or via e-mail.		

* Other versions of Windows are not supported. Only pre-installed operating systems are supported; operation is not guaranteed on home-built computers or computers that have been upgraded from earlier versions of Windows.

- 2 Start the computer. Log in to an account with administrator privileges before proceeding.
- 3 Exit any applications that may be running and insert the installer CD in a CD-ROM drive.

Windows 7/Windows Vista

If an AutoPlay dialog is displayed, click **SETUP.EXE**. A “User Account Control” dialog will then be displayed; click **Yes** (Windows 7) or **Allow** (Windows Vista).

The installer will start automatically; click **Install MyFinePix Studio** and follow the on-screen instructions to install MyFinePix Studio.

If the Installer Does Not Start Automatically

If the installer does not start automatically, select **Computer** or **My Computer** from the Start menu, then double-click the **FINEPIX** CD icon to open the FINEPIX CD window and double-click **setup** or **SETUP.EXE**.

- 4 If prompted to install Windows Media Player, DirectX, or .NET Framework, follow the on-screen instructions to complete installation.
- 5 Remove the installer CD from the CD-ROM drive when installation is complete. Store the installer CD in a dry location out of direct sunlight in case you need to re-install the software. The version number is printed at the top of the CD label for reference when updating the software or contacting customer support.

Installation is now complete. Proceed to “Connecting the Camera” on page 68.

Macintosh: Installing FinePixViewer

1 Confirm that the computer meets the following system requirements:

CPU	PowerPC or Intel
OS	Pre-installed versions of Mac OS X version 10.3.9–10.6 (for the latest information, visit http://www.fujifilm.com/)
RAM	256 MB or more
Free disk space	A minimum of 200 MB required for installation with 400 MB available when FinePixViewer is running
Video	800 × 600 pixels or more with thousands of colors or better
Other	<ul style="list-style-type: none"> • Built-in USB port recommended. Operation is not guaranteed with other USB ports. • Internet connection (broadband recommended) required to use auto update feature and when performing such tasks as sharing pictures on-line or via e-mail.

2 After starting the computer and quitting any applications that may be running, insert the installer CD in a CD-ROM drive and double-click **Installer for Mac OS X**.

3 An installer dialog will be displayed; click **Installing FinePixViewer** to start installation. Enter an administrator name and password when prompted and click **OK**, then follow the on-screen instructions to install FinePixViewer. Click **Exit** to quit the installer when installation is complete.

- 4 Remove the installer CD from the CD-ROM drive. Note that you may be unable to remove the CD if Safari is running; if necessary, quit Safari before removing the CD. Store the installer CD in a dry location out of direct sunlight in case you need to re-install the software. The version number is printed at the top of the CD label for reference when updating the software or contacting customer support.
- 5 **Mac OS X 10.5 or earlier:** Open the “Applications” folder, start Image Capture, and select **Preferences...** from the Image Capture application menu. The Image Capture preferences dialog will be displayed; choose **Other...** in the **When a camera is connected, open** menu, then select **FPVBridge** in the “Applications/FinePixViewer” folder and click **Open**. Quit Image Capture.
Mac OS X 10.6: Connect the camera and turn it on. Open the “Applications” folder and start Image Capture. The camera will be listed under **DEVICES**; select the camera and choose **FPVBridge** from the **Connecting this camera opens** menu and click **Open**. Quit Image Capture.

Installation is now complete. Proceed to “Connecting the Camera” on page 68.

Connecting the Camera

- 1 If the pictures you wish to copy are stored on a memory card, insert the card into the camera (pg. 11). If no card is inserted, pictures will be copied from internal memory.

← Note

Windows users may require the Windows CD when starting the software for the first time.

⚠ Caution

Loss of power during transfer could result in loss of data or damage to internal memory or the memory card. Charge the battery before connecting the camera.

- 2 Turn the camera off and connect the supplied USB cable as shown, making sure the connectors are fully inserted. Connect the camera directly to the computer; do not use a USB hub or keyboard.

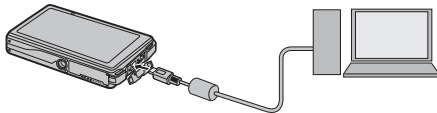

- 3 Press the button for about a second to turn the camera on. MyFinePix Studio or FinePixViewer will start automatically; follow the on-screen instructions to copy pictures to the computer. To exit without copying pictures, click **Cancel**.

⚠ Caution

If the software does not start automatically, it may not be correctly installed. Disconnect the camera and reinstall the software.

For more information on using the supplied software, start the application and select the appropriate option from the **Help** menu.

Cautions

- If a memory card containing a large number of images is inserted, there may be a delay before the software starts and you may be unable to import or save images. Use a memory card reader to transfer pictures.
- Make sure that the computer does not display a message stating that copying is in progress and that the indicator lamp is out before turning the camera off or disconnecting the USB cable (if the number of images copied is very large, the indicator lamp may remain lit after the message has cleared from the computer display). Failure to observe this precaution could result in loss of data or damage to internal memory or the memory card.
- Disconnect the camera before inserting or removing memory cards.
- In some cases, it may not be possible to access pictures saved to a network server using the supplied software in the same way as on a standalone computer.
- The user bears all applicable fees charged by the phone company or Internet service provider when using services that require an Internet connection.

Disconnecting the Camera

After confirming that the indicator lamp is out, follow the on-screen instructions to turn the camera off and disconnect the USB cable.

Uninstalling the Supplied Software

Only uninstall the supplied software when it is no longer required or before beginning reinstallation. After quitting the software and disconnecting the camera, drag the "FinePixViewer" folder from "Applications" into the Trash and select **Empty Trash** in the **Finder** menu (Macintosh), or open the control panel and use "Programs and Features" (Windows 7/Windows Vista) or "Add or Remove Programs" (Windows XP) to uninstall MyFinePix Studio. Under Windows, one or more confirmation dialogs may be displayed; read the contents carefully before clicking **OK**.















The Shooting Menu

The shooting menu is used to adjust settings for a wide range of shooting conditions.

Using the Shooting Menu

- 1** To view the shooting menu, tap the **MENU** icon when the camera is in shooting mode.
- 2** Tap the icon for the desired menu item.
- 3** Tap the desired option. In some menus, you may need to tap ▲ or ▼ to view additional options.

Shooting Menu Options

Menu item	Description	Options	Default
 EXP. COMPENSATION	Adjust exposure for bright, dark, or high-contrast scenes (pg. 72).	-2 EV to +2 EV in increments of 1/3 EV	±0
 ISO	Adjust ISO sensitivity (pg. 73). Choose higher values when the subject is poorly lit.	AUTO/AUTO (1600)/ AUTO (800)/AUTO (400)/3200/ 1600/800/400/200/100	AUTO
 IMAGE SIZE	Choose image size and aspect ratio (pg. 74).	L 4:3/L 16:9/M 4:3/ M 16:9/S 4:3/S 16:9	L 4:3
 IMAGE QUALITY	Choose image quality (pg. 75).	FINE/NORMAL	NORMAL
 DYNAMIC RANGE	Enhance details in highlights for natural contrast (pg. 75).	AUTO/R100/R200/R400	AUTO
 FILM SIMULATION	Simulate the effects of different types of film (pg. 75).	STD/V/B/SP	STD
 WHITE BALANCE	Adjust color for different light sources (pg. 76).	AUTO/☀/☁/🌧/🌫/🌫/🌫	AUTO
 CONTINUOUS	Shoot a series of pictures (pg. 76).	ON/OFF	OFF
 FACE DETECTION	Choose whether the camera automatically detects and sets focus and exposure for human portrait subjects. Can be combined with red-eye removal (pg. 30).	👤/👤/OFF	—
 AF MODE	Control how the camera focuses (pg. 77).	☐/+	☐
 DUAL IS MODE	Reduce blur (pg. 18).	👤 ON/OFF	👤 ON
 FRAMING GUIDELINE	Display best framing guides to help compose pictures (pg. 19).	ON/OFF	OFF
 SILENT MODE	Select ON in situations in which camera sounds or lights may be unwelcome (pg. 21).	ON/OFF	OFF
 SET-UP	Perform basic camera setup such as choosing a language and setting the time and date (pg. 85).	—	—

EXP. COMPENSATION

Use exposure compensation when photographing very bright, very dark, or high-contrast subjects.

An exposure indicator appears at the right side of the display; tap ▲ to increase exposure, ▼ to reduce.

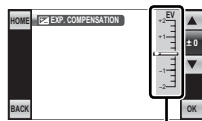

Exposure indicator

Tap ▲ to increase exposure



Tap ▼ to reduce exposure



Tap **OK** to exit when adjustments are complete.

Choosing an Exposure Compensation Value

- **Backlit subjects:** choose values from $+\frac{2}{3}$ EV to $+1\frac{2}{3}$ EV (for an explanation of the term “EV”, see the Glossary on page 109)



- **Highly reflective subjects or very bright scenes** (e.g., snowfields): +1 EV



- **Scenes that are mostly sky:** +1 EV

- **Spotlit subjects** (particularly if photographed against dark backgrounds): $-\frac{2}{3}$ EV

- **Subjects with low reflectivity** (pine trees or dark-colored foliage): $-\frac{2}{3}$ EV

Note

At settings other than ± 0 , a  icon is displayed in the monitor. Exposure compensation is not reset when the camera is turned off; to restore normal exposure control, choose a value of ± 0 .

ISO ISO

Control the camera's sensitivity to light. Higher values can be used to reduce blur when lighting is poor; note, however, that mottling may appear in pictures taken at high sensitivities. If **AUTO** is selected, the camera will adjust sensitivity automatically in response to shooting conditions. Settings other than **AUTO** are shown by an icon in the monitor.

👉 Note

ISO sensitivity is not reset when the camera is turned off.

📷 IMAGE SIZE

Choose the size and aspect ratio at which still pictures are recorded. Large pictures can be printed at large sizes with no drop in quality; small pictures require less memory, allowing more pictures to be recorded.

Option	Prints at sizes up to
L 4:3	34×25 cm (13.5×10 in.)
L 16:9	34×19 cm (13.5×7.5 in.)
M 4:3	24×18 cm (9.5×7 in.)
M 16:9	24×13 cm (9.5×5.5 in.)
S 4:3	17×13 cm (7×5 in.)
S 16:9	16×9 cm (6.5×3.5 in.)

The number of pictures that can be taken at each setting is displayed to the right of the option in the menu.

👉 Note

Image quality is not reset when the camera is turned off or another shooting mode is selected.

📐 Aspect Ratio

Pictures with an aspect ratio of 4:3 have the same proportions as the central display area of the camera monitor, while an aspect ratio of 16:9 is suited to display on High Definition (HD) devices.

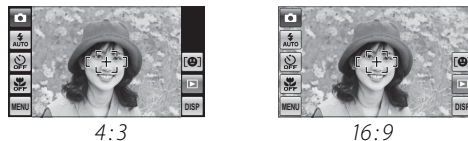

IMAGE QUALITY





Choose how much image files are compressed. Select **FINE** (low compression) for higher image quality, **NORMAL** (high compression) to increase the number of pictures that can be stored.

DYNAMIC RANGE

Control contrast. Higher values are recommended for scenes that include both sunlight and deep shade or for increased contrast with such subjects as sunlight on water, brightly-lit autumn leaves, portraits taken against a blue sky, and white objects or people wearing white; note, however, that mottling may appear in pictures taken at higher values. If **AUTO** is selected, the camera will automatically select values between 100% and 400% in response to shooting conditions.







FILM SIMULATION

Simulate the effects of different types of film, including sepia and black-and-white. Tap ▲ or ▼ to highlight an option and tap **OK** to select.

Option	Description
 PROVIA/ STANDARD	Standard color reproduction. Suited to a wide range of subjects, from portraits to landscapes.
 Velvia/ VIVID	A high-contrast palette of saturated colors, suited to nature photographs.
 B&W	Take pictures in black and white.
 SEPIA	Take pictures in sepia.

WB WHITE BALANCE

For natural colors, choose a setting that matches the light source (for an explanation of “white balance,” see the Glossary on page 109). Tap ▲ or ▼ to highlight an option and tap **OK** to select.

Option	Displayed in
AUTO	White balance adjusted automatically.
	For subjects in direct sunlight.
	For subjects in the shade.
	Use under “daylight” fluorescent lights.
	Use under “warm white” fluorescent lights.
	Use under “cool white” fluorescent lights.
	Use under incandescent lighting.

If **AUTO** does not produce the desired results (for example, when taking close-ups), choose the option that matches the light source.

Notes

- Turn the flash off (pg. 32) to take pictures that reflect the color of the original light source.
- Results vary with shooting conditions. Play pictures back after shooting to check colors in the monitor.

CONTINUOUS

Select **ON** to capture motion in a series of pictures. The camera takes up to five pictures while the shutter button is pressed.

Caution

The flash turns off when **CONTINUOUS** is on.

[AF] AF MODE

This option controls how the camera focuses when Intelligent Face Detection is off (pg. 30). Regardless of the option selected, the camera will focus on the subject in the center of the monitor when macro mode is on (pg. 37).

■ **[AF] AF MODE: [C] CENTER**

The camera focuses on the subject in the center of the monitor. This option can be used with focus lock.

■ **[AF] AF MODE: [+] MULTI**

When the shutter button is pressed halfway, the camera detects high-contrast subjects near the center of the monitor and selects the focus area automatically.

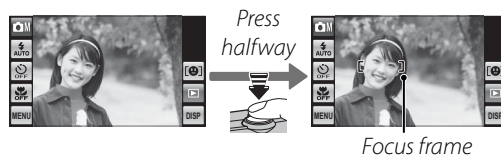

The Playback Menu













The playback menu is used to manage the pictures in internal memory or on the memory card.

Using the Playback Menu

- 1 To view the playback menu, tap the **MENU** icon during playback.
- 2 Tap the icon for the desired menu item.
- 3 Tap the desired option. In some menus, you may need to tap ▲ or ▼ to view additional options.

Playback Menu Options

The following options are available:

Option	Description
 PHOTOBOOK ASSIST	Create books from your favorite photos (pg. 56).
 FAVORITES	Rate pictures (pg. 44).
 PICTURE COMPARE	Display two pictures side-by-side (pg. 79).
 FOLDER MANAGEMENT	Organize pictures into folders (pg. 79).
 IMAGE SEARCH	Search for pictures by date, subject, scene, or file type (pg. 54).
 EDIT	Rotate pictures, make collages, or create cropped or resized copies of pictures (pg. 49).
 SLIDE SHOW	View pictures in a slide show (pg. 81).
 PROTECT	Protect pictures from accidental deletion (pg. 82).
 ERASE FACE RECOG.	Remove face recognition data from the current picture (pg. 83).
 ERASE	Delete all or selected pictures (pg. 47).
 MARK FOR UPLOAD TO	Select pictures for upload to YouTube or Facebook (pg. 83).
 SILENT MODE	Use in situations in which camera sounds or lights may be unwelcome (pg. 21).
 SET-UP	Perform basic camera setup (pg. 85).

PICTURE COMPARE

Display two pictures side by side. Tap a frame to highlight it and scroll left or right or tap ◀ or ▶ to choose the picture shown in the frame. To zoom in on the highlighted picture, tap 🔍, or tap 🗑️ to delete the highlighted picture.

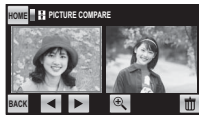

To exit to single-frame playback, tap **BACK**.

FOLDER MANAGEMENT

Selecting this option displays a folder selection dialog. Folders are identified by icons at the bottom of the display:



Folder	Default folder name
IN Internal memory	—
MY My pictures	110_FUJI
T1 Theme (1)	101FETC1
T2 Theme (2)	102FETC2
PR Private	100FPRIV

To choose a folder for playback, tap the icon at the bottom of the display. Tap ⤴ or ⤵ to view additional pictures in the current folder, or tap **OK** to return to single-frame playback. Only pictures in the selected folder will be displayed; to view pictures in all folders except **IN** and **PR**, select **ALL** in the folder management dialog.

Note

Folder management is only available when a memory card is inserted in the camera. Folders on memory cards from other cameras may not be organized as shown above.

The **Cam** Folder

The **Cam** folder is password protected. Tapping **Cam** displays a password entry dialog; enter a four-digit password by tapping the ▲ or ▼ icons and tap **OK**. In all other respects the **Cam** folder functions as a normal folder.



The password can be freely changed using the **PASSWORD** option in the setup menu (pg. 86). Note that password protection applies on the camera only; files are not encrypted and can be viewed normally on other devices.

■ Moving and Copying Pictures

To move or copy a picture between folders:

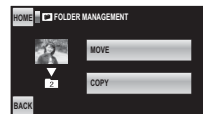

- 1 Select the folder containing the desired picture.
- 2 Tap the picture.
- 3 Tap the destination folder.
- 4 Tap **MOVE** or **COPY**, or tap **BACK** to exit without moving or copying the picture.





⚠ Caution

Copying ends when the destination is full.

SLIDE SHOW

View pictures in an automated slide show. After choosing the background music and display format, tap  **HORIZONTAL** to view the slide show in “wide” (landscape) orientation or  **VERTICAL** to view the slide show in “tall” (portrait) orientation. When a movie is displayed, movie playback will begin automatically, and the slide show will continue when the movie ends.

Option	Displayed in
NORMAL FADE-IN	Pictures are displayed one at a time. Select FADE-IN for fade transitions between frames.
NORMAL  FADE-IN 	As above, except that camera automatically zooms in on faces selected with Intelligent Face Detection (pg. 30), the auto release timer (pg. 35), or pet detection (pg. 25).
MULTIPLE	Display several pictures at once.
SELECT BGM	Choose background music.

Notes

- The camera will not turn off automatically while a slide show is in progress.
- To exit the slide show, tap the display and then tap **STOP**.

PROTECT

Protect pictures from accidental deletion. The following options are available.

■ FRAME

Protect selected pictures.



- 1 Tap  or  to select the desired picture.



Picture not protected



Protected picture

- 2 Tap  to protect the picture. If the picture is already protected, tapping  will remove protection from the image.
- 3 Repeat steps 1–2 to protect additional images. Tap **BACK** to exit when the operation is complete.

■ SET ALL

Tap **OK** to protect all pictures, or tap **BACK** to exit without changing picture status.



■ RESET ALL

Tap **OK** to remove protection from all pictures, or tap **BACK** to exit without changing picture status.



If the number of pictures affected is very large, a message will be displayed while the operation is in progress. Tap **BACK** to exit before the operation is complete.

Caution

Protected pictures will be deleted when the memory card or internal memory is formatted (pg. 90).

OFF ERASE FACE RECOG.

Remove face recognition links from the current image. When this option is selected, the camera will zoom in on an area in the current picture that it has matched with a face in the face recognition database. If the match is not correct, tap **OK** to remove the link to the face recognition database.

← Note

Face recognition links can not be removed from copies with a size of **640**.

🌐 MARK FOR UPLOAD TO

Select pictures for upload to YouTube or Facebook using MyFinePix Studio (Windows only).

■ Selecting Pictures for Upload

- 1 Tap **YouTube** to select movies for upload to YouTube, **FACEBOOK** to select photos and movies for upload to Facebook.
- 2 Tap **◀** or **▶** to display pictures and tap **OK** to select or deselect. Tap **BACK** to exit when all the desired pictures are selected.

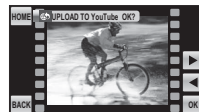

Not selected for upload



Selected for upload

← Notes

- Only movies can be selected for upload to YouTube.
- During playback, selected pictures are indicated by **🌐 YouTube** or **🌐 FACEBOOK** icons.

■ **RESET ALL: Deselecting All Pictures**

To deselect all pictures, tap **RESET ALL** and tap **OK**, or tap **BACK** to exit without changing picture status.



If the number of pictures affected is very large, a message will be displayed while the operation is in progress. Tap **BACK** to exit before the operation is complete.

■ **Uploading Pictures (Windows Only)**

Selected pictures can be uploaded using the **YouTube/Facebook Upload** option in MyFinePix Studio (Windows only).

Select with camera

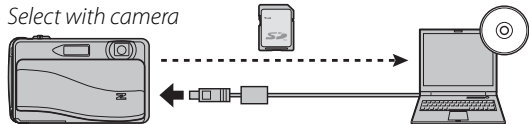

Upload from computer















For information on installing MyFinePix Studio and connecting the camera to a computer, see “Viewing Pictures on a Computer” (pg. 64).

The Setup Menu

Using the Setup Menu

- 1 Tap the **MENU** icon to display the menu for the current mode.
- 2 Tap **SET (Set-up)**.
- 3 Tap **▲** or **▼** to display the desired menu item and tap to select.
- 4 Tap the desired option.

Setup Menu Options

Menu item	Description	Options	Default
 IMAGE DISP.	Choose how long pictures are displayed after shooting (pg. 87).	3 SEC / 1.5 SEC / ZOOM / OFF	1.5 SEC
 FRAME NO.	Choose how files are named (pg. 88).	CONT. / RENEW	CONT.
 DUAL IS MODE	Choose whether image stabilization is performed at all times when the camera is in shooting mode ( 1 CONTINUOUS), or only when the shutter button is pressed halfway ( 2 SHOOTING ONLY) (pg. 18).	 1 /  2	 1
 ILLUMINATION	If ON is selected, the illuminator will light when the camera is turned on. It will also light after a picture is taken to let the subjects know that shooting is complete.	ON / OFF	ON
 DIGITAL ZOOM	Enable or disable digital zoom (pg. 89).	ON / OFF	OFF
 DATE/TIME	Set the camera clock (pg. 15).	—	—
 VOLUME	Adjust volume for the shutter, controls, and playback (pg. 89).	—	—
 SOUND	Choose shutter, start-up, and control sounds (pg. 89).	—	—
 LCD BRIGHTNESS	Control the brightness of the monitor (pg. 89).	—	0
 FORMAT	Format internal memory or memory cards (pg. 90).	—	—























Menu item	Description	Options	Default
 言語/LANG.	Choose a language (pg. 15).	See page 112	ENGLISH
 AUTO POWER OFF	Choose the auto power off delay (pg. 91).	5 MIN / 2 MIN / OFF	2 MIN
 TIME DIFFERENCE	Set the clock to local time (pg. 92).		
 AUTOROTATE PB	Choose ON to automatically rotate "tall" (portrait) orientation pictures during playback.	ON / OFF	ON
 BACKGROUND COLOR	Choose a color scheme.	BLACK / GOLD / RED / PINK	—
 POWER MANAGEMENT	Optimize camera performance for increased battery life, quick focus, or display quality (pg. 93).		
 RESET	Reset all settings except  DATE/TIME and  TIME DIFFERENCE to default values. A confirmation dialog will be displayed, tap OK to reset.	—	—
 PASSWORD	Protect the  folder with a password (pg. 80).	—	—
 CALIBRATION	Calibrate the touch panel (pg. 94).	—	—
 VERSION INFO	View the current camera firmware version.	—	—

IMAGE DISP.

Choose an option other than **OFF** to display pictures in the monitor after shooting. Pictures can be displayed for 1.5 s (**1.5 SEC**), 3 s (**3 SEC**), or until you tap **OK (ZOOM (CONTINUOUS))**. If **ZOOM (CONTINUOUS)** is selected, photos can be zoomed in to check focus and other fine details (pg. 45); tap ▲, ▼, ◀, or ▶ to scroll the display (note that zoom is disabled in  mode and when **ON** is selected for  **CONTINUOUS** as described on page 76).

Intelligent Face Detection/Pet Detection

When **ZOOM (CONTINUOUS)** is selected, the camera will automatically zoom in on faces of portrait subjects detected with Intelligent Face Detection or the auto release timer or of animals detected with  **DOG** or  **CAT**. If the camera has detected more than one such subject, you can tap  (Intelligent Face Detection) or  (pet detection) to scroll from face to face.

Note

The colors displayed at settings of **3 SEC** and **1.5 SEC** may differ from those in the final picture.

FRAME NO.

New pictures are stored in image files named using a four-digit file number assigned by adding one to the last file number used. The file number is displayed during playback as shown at right. **FRAME NO.** controls whether file numbering is reset to 0001 when a new memory card is inserted or the current memory card or internal memory is formatted.

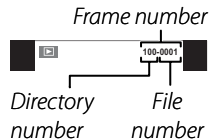



- **CONTINUOUS:** Numbering continues from the last file number used or the first available file number, whichever is higher. Choose this option to reduce the number of pictures with duplicate file names.
- **RENEW:** Numbering is reset to 0001 after formatting or when a new memory card is inserted.

Notes

- If the frame number reaches 999-9999, the shutter release will be disabled (pg. 107).
- Selecting **RESET** (pg. 86) sets **FRAME NO.** to **CONTINUOUS** but does not reset the file number.
- Frame numbers for pictures taken with other cameras may differ.

DIGITAL ZOOM

If **ON** is selected, selecting  at the maximum optical zoom position will trigger digital zoom, further magnifying the image. To cancel digital zoom, zoom out to the minimum digital zoom position and select .

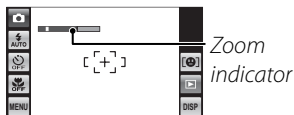

Zoom indicator,
DIGITAL ZOOM off

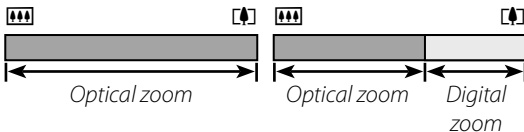



Zoom indicator,
DIGITAL ZOOM on

Caution

Digital zoom produces lower quality images than optical zoom.

VOLUME

Adjust volume for the shutter, controls, and playback. Tap an option and choose a volume, either by selecting an option in a menu (shutter and control volume) or by tapping  and  to choose a setting between **OFF** and 10 (playback volume). Tap **OK** when settings are complete.

SOUND

Choose the sounds used for the shutter, at start-up, and for camera controls. Tap an option and then tap an icon to choose the sound. Tap **OK** when settings are complete.

LCD BRIGHTNESS

Tap  or  to adjust monitor brightness. Tap **OK** when settings are complete.







FORMAT

Format internal memory or a memory card. If a memory card is inserted in the camera, this option will format the memory card. If no memory card is inserted, this option will format internal memory. Tap **OK** to begin formatting. To exit without formatting, tap **BACK**.

Cautions

- All data—including protected pictures—will be deleted from the memory card or internal memory. Be sure important files have been copied to a computer or other storage device.
- Do not open the battery cover during formatting.

AUTO POWER OFF

Choose the length of time before the camera turns off automatically when no operations are performed. Shorter times increase battery life; if **OFF** is selected, the camera must be turned off manually. Note that regardless of the option selected, the camera will not turn off automatically when connected to a printer (pg. 62) or computer (pg. 68) or when a slide show is in progress (pg. 81), and that even if **OFF** is selected the camera will turn off automatically if no operations are performed for five minutes in  or movie mode or when an option other than  **POWER SAVE** is selected for  **POWER MANAGEMENT**, an option other than **OFF** is selected for  **FACE DETECTION**, or  **PORTRAIT ENHANCER**,  **DOG**, or  **CAT** is selected in **SP** mode.

Tip: Reactivating the Camera





To reactivate the camera after it has turned off automatically, close and reopen the lens cover or press the  button for about a second (pg. 14).

TIME DIFFERENCE





When traveling, use this option to switch the camera clock instantly from your home time zone to the local time at your destination.

1 Specify the difference between local time and your home time zone.

1.1 Tap  LOCAL.

1.2 Tap the , , , and  icons to choose the time difference. The minimum increment is 15 minutes. Tap **OK** when settings are complete.



2 Switch between local time and your home time zone.

To set the camera clock to local time, tap  LOCAL. To set the clock to the time in your home time zone, tap  HOME. If  LOCAL is selected,  will be displayed in the monitor for three seconds after the camera enters shooting mode, and the date will be displayed in yellow.



After changing time zones, check that the date and time are correct.

POWER MANAGEMENT

Optimize camera performance for increased battery life, quick focus response, or improved display quality. The following options are available:

-  **POWER SAVE:** Reduces monitor refresh rate. If no operations are performed for 10 s, the monitor will dim to save power. Select this option to save power or to prevent vertical streaks from appearing in photos when the camera is used for extended periods at high temperatures.
-  **QUICK AF:** Reduces focusing time, ensuring a quick shutter response.
-  **CLEAR DISPLAY:** Choose this option for a brighter, higher quality display.

Notes

-  **POWER SAVE** does not take effect when Intelligent Face Detection is on.
- Settings other than  **POWER SAVE** increase the drain on the battery; pay attention to battery level. The monitor will dim automatically if no operations are performed for 30 s. If **OFF** is selected for  **AUTO POWER OFF** (pg. 91), the camera will turn off automatically if no operations are performed for five minutes.

CALIBRATION

Calibrate the touch panel. Tap the “+” symbols in the order shown below at left (if you tap too far from the correct symbol, an error will be displayed; tap the correct symbol again). The message shown below at right will be displayed when calibration is complete. Tap **OK** to exit.





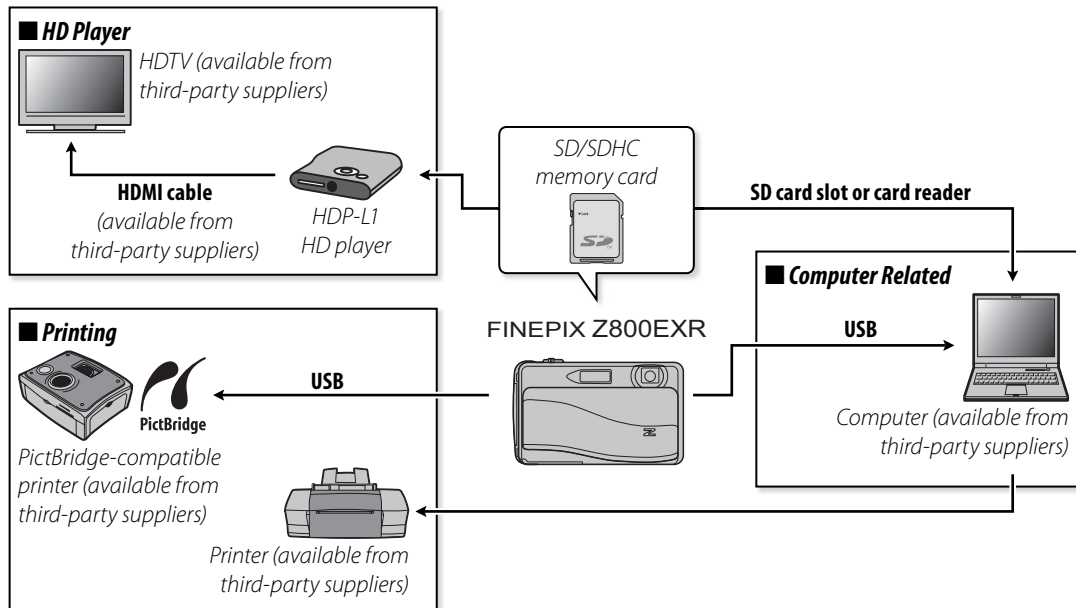

Optional Accessories

The camera supports a wide range of accessories from FUJIFILM and other manufacturers.

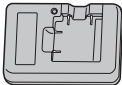

Accessories from FUJIFILM

The following optional accessories are available from FUJIFILM. For the latest information on the accessories available in your region, check with your local FUJIFILM representative or visit http://www.fujifilm.com/products/digital_cameras/index.html.

Rechargeable Li-ion batteries	NP-45/NP-45A	In addition to the supplied NP-45A battery, the camera can be used with NP-45 slimline batteries (available separately).	
Battery chargers	BC-45W	Replacement battery chargers can be purchased as required. The BC-45W charges an NP-45A or NP-45 battery in about 120 minutes at +23 °C (+73 °F).	
AC power adapters	AC-5VX (requires CP-45 DC coupler)	Use for extended playback or when copying pictures to a computer (shape of adapter and plug vary with region of sale).	
DC couplers	CP-45	Connect the AC-5VX to the camera.	
HD players	HDP-L1 (requires HDMI cable, available from third-party suppliers)	Connect to a High Definition (HD) TV to view photographs and movies from SD memory cards.	

Caring for the Camera

To ensure continued enjoyment of the product, observe the following precautions.

Storage and Use

If the camera will not be used for an extended period, remove the battery and memory card. Do not store or use the camera in locations that are:

- exposed to rain, steam, or smoke
- very humid or extremely dusty
- exposed to direct sunlight or very high temperatures, such as in a closed vehicle on a sunny day
- extremely cold
- subject to strong vibration
- exposed to strong magnetic fields, such as near a broadcasting antenna, power line, radar emitter, motor, transformer, or magnet
- in contact with volatile chemicals such as pesticides
- next to rubber or vinyl products

Water and Sand

Exposure to water and sand can also damage the camera and its internal circuitry and mechanisms. When using the camera at the beach or seaside, avoid exposing the camera to water or sand. Do not place the camera on a wet surface.

Condensation

Sudden increases in temperature, such as occur when entering a heated building on a cold day, can cause condensation inside the camera. If this occurs, turn the camera off and wait an hour before turning it on again. If condensation forms on the memory card, remove the card and wait for the condensation to dissipate.

Cleaning



Use a blower to remove dust from the lens and monitor, then gently wipe with a soft, dry cloth. Any remaining stains can be removed by wiping gently with a piece of FUJIFILM lens-cleaning paper to which a small amount of lens-cleaning fluid has been applied. Care should be taken to avoid scratching the lens or monitor. The camera body can be cleaned with a soft, dry cloth. Do not use alcohol, thinner, or other volatile chemicals.

Traveling

Keep the camera in your carry-on baggage. Checked baggage may suffer violent shocks that could damage the camera.

Troubleshooting







Power and Battery



	Problem	Possible cause	Solution	Page
Power supply	The camera does not turn on.	The battery is exhausted.	Charge the battery or insert a fully-charged spare battery.	8, 9
		The battery is not in the correct orientation.	Reinsert the battery in the correct orientation.	9
		The AC adapter and DC coupler are not connected properly.	Make sure that the AC adapter and DC coupler are properly connected.	—
	The battery runs down quickly.	The battery is cold.	Warm the battery by placing it in a pocket or other warm place and reinsert it in the camera immediately before taking a picture.	vi, 9
		There is dirt on the battery terminals.	Clean the terminals with a soft, dry cloth.	—
		 is selected for shooting mode.	Select  mode to reduce the drain on the battery.	23
		The battery has been charged many times.	The battery has reached the end of its charging life. Purchase a new battery.	—
	The camera turns off suddenly.	The battery is exhausted.	Charge the battery or insert a fully-charged spare battery.	8, 9
The AC adapter or DC coupler has been disconnected.		Make sure that the AC adapter and DC coupler are properly connected.	—	
Battery charger	Charging does not start.	The battery is not correctly inserted.	Reinsert the battery in the charger.	8
		The battery is not in the correct orientation.	Reinsert the battery in the correct orientation.	8
	Charging is slow.	The temperature is low.	Charge the battery at room temperature.	vi
	The charging lamp lights, but the battery does not charge.	There is dirt on the battery terminals.	Clean the terminals with a soft, dry cloth.	—
		The battery has been charged many times.	The battery has reached the end of its charging life. Purchase a new battery. If the battery still fails to charge, contact your FUJIFILM dealer.	—

Menus and Displays

Problem	Possible cause	Solution	Page
Menus and displays are not in English.	English is not selected for the 言語/LANG. option in the setup menu.	Select ENGLISH .	15, 86

Shooting

	Problem	Possible cause	Solution	Page
Taking pictures	No picture is taken when the shutter button is pressed.	Memory is full.	Insert a new memory card or delete pictures.	12, 47
		Memory is not formatted.	Format the memory card or internal memory.	90
		There is dirt on the memory card contacts.	Clean the contacts with a soft, dry cloth.	—
		The memory card is damaged.	Insert a new memory card.	12
		The battery is exhausted.	Charge the battery or insert a fully-charged spare battery.	8, 9
	The camera has turned off automatically.	Turn the camera on.	14	
	The monitor goes dark after shooting.	The flash has fired.	The monitor may darken while the flash charges. Wait for the flash to charge.	32
Focus	The camera does not focus.	The subject is close to the camera.	Select macro mode.	37
		The subject is far away from the camera.	Cancel macro mode.	
		The subject is not suited to autofocus.	Use focus lock.	38
	Pictures are not the same size.	 is selected for  IMAGE SIZE .	If AUTO is selected for  IMAGE SIZE in  mode, the camera will optimize not only sensitivity and other settings, but also image size. To record all pictures at the same size, choose another option for  IMAGE SIZE .	17, 74
Panoramas	Cannot shoot.	The indicator lamp glows orange: pictures are being recorded.	Wait until the indicator lamp turns off.	20

	Problem	Possible cause	Solution	Page
Intelligent Face Detection	Face detection not available.	Intelligent Face Detection is not available in the current shooting mode.	Choose a different shooting mode.	23
	No face is detected.	The subject's face is obscured by sunglasses, a hat, long hair, or other objects.	Remove the obstructions.	30
		The subject's face occupies only a small area of the frame.	Change the composition so that the subject's face occupies a larger area of the frame.	
		The subject's head is tilted or horizontal.	Ask the subject to hold their head straight.	19
		The camera is tilted.	Hold the camera straight.	
		The subject's face is poorly lit.	Shoot in bright light.	—
Wrong subject selected.	The selected subject is closer to the center of the frame than the main subject.	Recompose the picture or turn face detection off and frame the picture using focus lock.	30, 38	
Flash	The flash does not fire.	The flash is not available in the current shooting mode.	Choose a different shooting mode.	23
		The battery is exhausted.	Charge the battery or insert a fully-charged spare battery.	8, 9
		The camera is in continuous mode.	Select OFF for  CONTINUOUS .	76
		The camera is in silent mode.	Turn silent mode off.	21
		The flash is off ().	Choose a different flash mode.	32
	Some flash modes are not available.	The desired flash mode is not available in the current shooting mode.	Choose a different shooting mode.	23
		The camera is in silent mode.	Turn silent mode off.	21
	The flash does not fully light the subject.	The subject is not in range of the flash.	Position the subject in range of the flash.	112
The flash window is obstructed.		Hold the camera correctly.	19	

	Problem	Possible cause	Solution	Page
Close-ups	Macro mode is not available.	Macro mode is not available in the current shooting mode.	Choose a different shooting mode.	23
Problem images	Pictures are blurred.	The lens is dirty.	Clean the lens.	97
		The lens is blocked.	Keep objects away from the lens.	19
		!AF is displayed during shooting and the focus frame is displayed in red.	Check focus before shooting.	20, 38, 105
		 is displayed during shooting.	Use the flash or a tripod.	32
	Pictures are mottled.	Slow shutter speed selected at high temperatures.	This is normal and does not indicate a malfunction.	—
	Vertical lines appear in pictures.	The camera has been used continuously at high temperatures.	Turn the camera off and wait for it to cool down.	14
"Smear" in the form of vertical purple or white lines appears in the display.	The camera has been used continuously at high ambient temperatures.	Vertical purple or white lines may appear when a very bright object is in the frame; this phenomenon is common to all CCD image sensors and does not indicate a malfunction. These lines are recorded in movies but do not appear in photographs. Avoid framing bright objects when filming movies.	109	
	The sun or another very bright object appears in the frame.			
Recording	Pictures are not recorded.	Power was interrupted during shooting.	Turn the camera off before connecting the AC adapter/DC coupler. Leaving the camera on can result in corrupted files or damage to the memory card or internal memory.	14

Playback

	Problem	Possible cause	Solution	Page
Pictures	Pictures are grainy.	The pictures were taken with a different make or model of camera.	—	—
	Playback zoom unavailable.	The pictures have an image size of 640 or were created with a different make or model of camera.	—	—
Audio	No sound in movie playback.	Playback volume is too low.	Adjust playback volume.	89
		The microphone was obstructed.	Hold the camera correctly during recording.	59
		The speaker is obstructed.	Hold the camera correctly during playback.	61
Deletion	Selected pictures are not deleted.	Some of the pictures selected for deletion are protected.	Remove protection using the device with which it was originally applied.	82

Connections



	Problem	Possible cause	Solution	Page
Computer	The computer does not recognize the camera.	The camera is not properly connected.	Connect the camera correctly.	68
PictBridge	Pictures can not be printed.	The camera is not properly connected.	Connect the camera correctly.	62
		The printer is off.	Turn the printer on.	—
	Only one copy is printed. The date is not printed.	The printer is not PictBridge-compatible.	Some printers may only print one copy or may not print the date.	—
AC adapter DC coupler	Help text is displayed.	The camera was turned on while being powered by an AC adapter.	Follow the on-screen instructions to enter demo mode or press the shutter button to cancel.	—



Miscellaneous

Problem	Possible cause	Solution	Page
The camera is unresponsive.	Temporary camera malfunction.	Remove and reinsert the battery or disconnect and reconnect the AC adapter/DC coupler.	9–10
	The battery is exhausted.	Charge the battery or insert a fully-charged spare battery.	8, 9
The camera does not function as expected.	Temporary camera malfunction.	Remove and reinsert the battery or disconnect and reconnect the AC adapter/DC coupler. If the problem persists, contact your FUJIFILM dealer.	9–10
No sound.	The camera is in silent mode.	Turn silent mode off.	21
The camera does not respond to the touch panel, or does not perform the expected action when the touch panel is used.	The touch panel requires calibration.	Calibrate the touch panel.	94
	The hand that is holding the camera is touching the panel.	Adjust your grip so that the hand that is holding the camera is not touching the panel.	—

Warning Messages and Displays

The following warnings are displayed in the monitor:

Warning	Description	Solution
 (red)	Low battery.	Charge the battery or insert a fully-charged spare battery.
 (blinks red)	Battery exhausted.	
	Slow shutter speed. Picture may be blurred.	Use the flash or mount the camera on a tripod.
!AF (displayed in red with red focus frame)	The camera can not focus.	<ul style="list-style-type: none"> • Use focus lock to focus on another subject at the same distance, then recompose the picture (pg. 38). • If the subject is poorly lit, try focusing at a distance of about 2 m (6 ft. 7 in.). • Use macro mode to focus when taking close-ups.
Aperture or shutter speed displayed in red	The subject is too bright or too dark. The picture will be over- or under-exposed.	If the subject is dark, use the flash.
LENS COVER	Attempted to take photograph with lens cover closed.	Open lens cover before taking photographs.
FOCUS ERROR	Camera malfunction.	Turn the camera off and then on again, taking care not to touch the lens. If the message persists, contact a FUJIFILM dealer.
ZOOM ERROR		
LENS CONTROL ERROR		
NO CARD	No memory card inserted when using folder management.	Insert a memory card.
CARD NOT INITIALIZED	The memory card or internal memory is not formatted.	Format the memory card or internal memory (pg. 90).
	The memory card contacts require cleaning.	Clean the contacts with a soft, dry cloth. If the message is repeated, format the memory card (pg. 90). If the message persists, replace the memory card.
	Camera malfunction.	Contact a FUJIFILM dealer.

Warning	Description	Solution
PROTECTED CARD	The memory card is locked.	Unlock the memory card (pg. 11).
BUSY	The memory card is incorrectly formatted.	Use the camera to format the memory card (pg. 90).
CANNOT RESIZE	An attempt was made to resize a 640 picture.	640 pictures can not be resized.
CARD ERROR	The memory card is not formatted for use in the camera.	Format the memory card (pg. 90).
	The memory card contacts require cleaning or the memory card is damaged.	Clean the contacts with a soft, dry cloth. If the message is repeated, format the memory card (pg. 90). If the message persists, replace the memory card.
	Incompatible memory card.	Use a compatible memory card (pg. 11).
	Camera malfunction.	Contact a FUJIFILM dealer.
 MEMORY FULL		
 MEMORY FULL		
INTERNAL MEMORY IS FULL INSERT A NEW CARD	The memory card or internal memory is full; pictures can not be recorded or copied.	Delete pictures or insert a memory card with more free space (pp. 12, 47).
WRITE ERROR	Memory card error or connection error.	Reinsert the memory card or turn the camera off and then on again. If the message persists, contact a FUJIFILM dealer.
	Not enough memory remaining to record additional pictures.	Delete pictures or insert a memory card with more free space.
	The memory card or internal memory is not formatted.	Format the memory card or internal memory (pg. 90).
READ ERROR	The file is corrupt or was not created with the camera.	The file can not be played back.
	The memory card contacts require cleaning.	Clean the contacts with a soft, dry cloth. If the message is repeated, format the memory card (pg. 90). If the message persists, replace the memory card.
	Camera malfunction.	Contact a FUJIFILM dealer.

Warning	Description	Solution
FRAME NO. FULL	The camera has run out of frame numbers (current frame number is 999-9999).	Format the memory card and select RENEW for FRAME NO. in the setup menu. Take a picture to reset frame numbering to 100-0001, then select CONTINUOUS for FRAME NO. (pg. 88).
TOO MANY FRAMES	A search has returned more than 30,000 results (or more than 4,999 for BY DATE).	Choose a search that returns fewer results.
	You have attempted to create collages with a total of over 30,000 images.	No further collages can be created until you have deleted files or inserted a new memory card.
FILE NUMBER FULL	Memory card contains 30,000 images. No new pictures can be recorded.	Delete files or insert new memory card.
PROTECTED FRAME	An attempt was made to delete or rotate a protected picture.	Remove protection before deleting or rotating pictures (pg. 82).
PASSWORD INCORRECT	The password you entered is not correct.	Enter the correct password or make a new password (pg. 80).
CAN NOT CROP	An attempt was made to crop a picture.	These pictures can not be cropped.
CAN NOT CROP	The picture selected for cropping is damaged or was not created with the camera.	
CAN NOT ROTATE	The picture can not be rotated.	—
CAN NOT ROTATE	Movies can not be rotated.	—
CANNOT EXECUTE	Red-eye removal can not be applied to the selected picture or movie.	—
CANNOT EXECUTE		
DEACTIVATE SILENT MODE	An attempt was made to choose a flash mode or adjust the volume with the camera in silent mode.	Exit silent mode before choosing a flash mode or adjusting the volume (pg. 21).
COMMUNICATION ERROR	A connection error occurred while pictures were being printed or copied to a computer or other device.	Confirm that the device is turned on and that the USB cable is connected.

Warning	Description	Solution
PRINTER ERROR	Printer out of paper or ink, or other printer error.	Check printer (see printer manual for details). To resume printing, turn the printer off and then turn it back on.
PRINTER ERROR RESUME?		Check printer (see printer manual for details). If printing does not resume automatically, tap OK to resume.
CANNOT BE PRINTED	An attempt was made to print a movie, a picture not created with the camera, or a picture in a format not supported by the printer.	Movies and some pictures created with other devices can not be printed. If the picture was created with the camera, check the printer manual to confirm that the printer supports the JFIF-JPEG or Exif-JPEG format. If it does not, the pictures can not be printed.

Glossary

Digital zoom: Unlike optical zoom, digital zoom does not increase the amount of visible detail. Instead, details visible using optical zoom are simply enlarged, producing a slightly “grainy” image.

EV (Exposure Value): The exposure value is determined by the sensitivity of the image sensor and the amount of light that enters the camera while the image sensor is exposed. Each time the amount of light doubles, EV increases by one; each time the amount of light is halved, EV decreases by one. The amount of light entering the camera can be controlled by adjusting aperture and shutter speed.

Exif Print: A standard that allows information stored with pictures to be used for optimal color reproduction during printing.

JPEG (Joint Photographic Experts Group): A compressed file format for color images. The higher the compression rate, the greater the loss of information and more noticeable drop in quality when the picture is displayed.









Motion JPEG: An AVI (Audio Video Interleave) format that stores images and sound in a single file, with the images recorded in JPEG format. Motion JPEG files can be played in QuickTime 3.0 or later.



Smear: A phenomenon specific to CCDs which causes white streaks to appear when very bright light sources, such as the sun or reflected sunlight, appear in the frame.

White balance: The human brain automatically adapts to changes in the color of light, with the result that objects that appear white under one light source still appear white when the color of the light source changes. Digital cameras can mimic this adjustment by processing images according to the color of the light source. This process is known as “white balance.”

Internal Memory/Memory Card Capacity















The following table shows the recording time or number of pictures available at different image sizes. All figures are approximate; file size varies with the scene recorded, producing wide variations in the number of files that can be stored. The number of exposures or length remaining may not diminish at an even rate. A limited number of test pictures can be taken when no memory card is inserted.

	Medium	Internal memory (approx. 30 MB)		4 GB		8 GB	
		FINE	NORMAL	FINE	NORMAL	FINE	NORMAL
Photographs	 4:3	6	9	830	1330	1680	2670
	 16:9	8	13	1110	1770	2240	3550
	 4:3	9	19	1340	2640	2700	5290
	 16:9	13	26	1770	3440	3550	6910
	 4:3	18	37	2480	4770	4980	9570
	 16:9	28	42	3760	5640	7540	11310
Movies ¹	 ²	—		21 min.		42 min.	
		22 sec.		50 min.		100 min.	

- Recording times shown here are the approximate total time of all recorded movies. Individual movies cannot exceed 10 minutes in length in , or 15 minutes in length in .
- Use a card with a class 4 write speed (4 MB/s) or better when shooting HD movies.

Specifications

System	
Model	Digital Camera FinePix Z800EXR
Effective pixels	12 million
CCD	½-in., Super honeycomb EXR CCD with primary color filter
Storage media	<ul style="list-style-type: none"> Internal memory (approx. 30 MB) SD/SDHC memory cards (see page 11)
File system	Compliant with Design Rule for Camera File System (DCF), and Exif 2.3
File format	<ul style="list-style-type: none"> Still pictures: Exif 2.3 JPEG (compressed) Movies: Motion JPEG AVI
Image size (pixels, file size)	<ul style="list-style-type: none"> L 4:3: 4,000 × 3,000 (12 M) L 16:9: 4,000 × 2,248 (9 M) M 4:3: 2,816 × 2,112 (6 M) M 16:9: 2,816 × 1,584 (4 M) S 4:3: 2,048 × 1,536 (3 M) S 16:9: 1,920 × 1,080 (2 M) Motion Panorama 360: Vertical; 7,680 × 920, Horizontal; 7,680 × 616 Motion Panorama 240: Vertical; 5,120 × 920, Horizontal; 5,120 × 616 Motion Panorama 120: Vertical; 2,560 × 920, Horizontal; 2,560 × 616
Lens	Fujinon 5× optical zoom lens, F/3.9 (wide angle)–4.7 (telephoto)
Focal length	f=6.4 mm–32 mm (35-mm format equivalent: 35 mm–175 mm)
Digital zoom	<ul style="list-style-type: none"> L / M: Approx. 4× (up to 20× when combined with optical zoom) S: Approx. 4.4× (up to 22× when combined with optical zoom)
Aperture	F3.9/F6.4 (wide angle), F4.7/F8.0 (telephoto)
Focus range (distance from front of lens)	<ul style="list-style-type: none"> Normal focus: approx. 60 cm (2 ft.)–∞ (wide angle); 100 cm (3.3 ft.)–∞ (telephoto) Macro mode: approx. 9 cm–80 cm/0.3 ft.–2.6 ft. (wide angle); 40 cm–80 cm/1.3 ft.–2.6 ft. (telephoto)
Sensitivity	Standard output sensitivity equivalent to ISO 100, 200, 400, 800, 1600; 3200 (image size M or S); AUTO
Metering	256-segment through-the-lens (TTL) matrix metering
Exposure control	Programmed auto exposure, manual exposure
Exposure compensation	–2 EV–+2 EV in increments of ⅓ EV (M mode)
Shooting modes	EXR EXR, AUTO AUTO, TOUCH & SHOOT , SP SCENE POSITION, N NATURAL LIGHT/NATURAL & MOTION PANORAMA 360 , M MANUAL, MOVIE
Scene modes	PORTRAIT , PORTRAIT ENHANCER , LANDSCAPE , SPORT , NIGHT , NIGHT (TRIPOD) , FIREWORKS , SUNSET , SNOW , BEACH , PARTY , FLOWER , TEXT , DOG , CAT

System	
Image stabilization	Optical stabilization (CCD shift)
Intelligent Face Detection	Available
Shutter speed	<ul style="list-style-type: none"> • : 1/60 s–1/1,000 s • : 1/4 s–1/500 s • : 4 s–1/2 s • : 3 s–1/500 s <p>• Other modes: 1/4 s–1/1,000 s</p>
Continuous	Up to five frames at a maximum of approximately 1.6 fps
Focus	<ul style="list-style-type: none"> • Mode: Center AF, Continuous AF () • Autofocus system: Hybrid AF (contrast-detect AF/phase detection AF) • Focus-area selection: Touch () , AF CENTER, and AF MULTI
White balance	Automatic scene detection; six manual preset modes for direct sunlight, shade, daylight fluorescent, warm white fluorescent, cool white fluorescent, and incandescent lighting
Self-timer	 auto release;  couple timer;  group timer;  auto release ( and ); timer with approx. 2 s or 10 s delay; OFF
Flash	Auto flash; effective range when sensitivity is set to ISO 800 is approx. 30 cm–3.9 m/1.0 ft.–12.8 ft. (wide angle) or 40 cm–3.2 m/1.3 ft.–10.5 ft. (telephoto)
Flash modes	Auto, fill flash, off, auto slow sync (red-eye removal off); auto with red-eye reduction, fill flash with red-eye reduction, off, slow sync with red-eye reduction (red-eye removal on)
Monitor	3.5-in., 460k-dot color LCD monitor; frame coverage approx. 100%; aspect ratio 16:9
Movies	Camera can record movies with a frame size of 1280×720 ( ; 24 fps) or 640×480 ( ; 30 fps); zoom not available during recording
Shooting menu	Silent mode, Intelligent Face Detection with red-eye removal, continuous shooting, framing guide, film simulation
Playback mode	Edit, image search, folder management, favorites, photobook assist
Other options	PictBridge, Exif Print, language selection (Arabic, Simplified Chinese, Traditional Chinese, Czech, Danish, Dutch, English, Farsi, Finnish, French, German, Greek, Hebrew, Hungarian, Indonesian, Italian, Japanese, Korean, Lithuanian, Norwegian, Polish, Portuguese, Romanian, Russian, Slovak, Spanish, Swedish, Thai, Turkish, Ukrainian, and Vietnamese), time difference

Input/output terminals**Digital input/output** USB 2.0 High Speed**Power supply/other****Power sources**

- NP-45A rechargeable battery
- AC-5VX AC power adapter and CP-45 DC coupler (sold separately)

Battery life (approximate number of frames that can be taken with fresh or fully charged batteries)

Battery type	Approximate number of frames
NP-45A (type supplied with camera)	170

CIPA standard, measured in **Auto** (auto) mode using battery supplied with camera and SD memory card.**Note:** Number of shots that can be taken with battery varies with battery charge level and will decline at low temperatures.**Camera dimensions (W×H×D)**

98.1 mm×59.0 mm×20.3 (16.9") mm/3.9 in.×2.3 in.×0.8 (0.7") in.

* excluding projecting parts, measured at the thinnest part

Camera weight

Approx. 141 g/5.0 oz., excluding battery, accessories, and memory cards

Shooting weight

Approx. 158 g/5.6 oz., including battery and memory card

Operating conditions

- **Temperature:** 0 °C – +40 °C/+32 °F – +104 °F
- **Humidity:** 10%–85% (no condensation)

NP-45A rechargeable battery

Nominal voltage	DC 3.7V
Nominal capacity	720mAh
Operating temperature	0°C – +40°C/+32°F – +104°F
Dimensions (W × H × D)	31.0 mm × 39.6 mm × 6.0 mm/1.2 in. × 1.6 in. × 0.2 in.
Weight	Approx. 15.5 g/0.5 oz.

BC-45W battery charger

Rated input	100V–240V AC, 50/60 Hz
Input capacity	8.0 VA (100V) 12 VA (240 V)
Rated output	4.2 V DC, 550 mA
Supported batteries	NP-45A rechargeable batteries
Charging time	Approx. 120 minutes
Dimensions (W × H × D)	91 mm × 62 mm × 23 mm/3.6 in. × 2.4 in. × 0.9 in.
Weight	Approx. 67 g/2.4 oz., excluding battery
Operating temperature	0°C – +40°C/+32°F – +104°F

Weight and dimensions vary with the country or region of sale.

Notices

- Specifications subject to change without notice. FUJIFILM shall not be held liable for damages resulting from errors in this manual.
- Although the monitor is manufactured using advanced high-precision technology, small bright points and anomalous colors may appear, particularly in the vicinity of text. This is normal for this type of monitor and does not indicate a malfunction; images recorded with the camera are unaffected.
- Digital cameras may malfunction when exposed to strong radio interference (e.g., electric fields, static electricity, or line noise).
- Due to the type of lens used, some distortion may occur at the periphery of images. This is normal.

FUJIFILM

FUJIFILM Corporation

7-3, AKASAKA 9-CHOME, MINATO-KU, TOKYO 107-0052, JAPAN

<http://www.fujifilm.com>