

# ROBERTS

Sound for Generations

# CLASSIC *f*M RD-12CFM

DAB digital radio



**DAB**  
Digital Audio Broadcasting

Please read this manual before use

## Contents

<i>Controls</i> .....	2	<i>Guarantee</i> .....	18
<i>Battery operation</i> .....	3		
<i>Mains operation</i> .....	3		
<i>Operating your radio</i> .....	4		
<i>Selecting a station</i> .....	5		
<i>Secondary services</i> .....	6		
<i>Display modes</i> .....	6		
<i>Finding new stations</i> .....	7		
<i>Autoselect</i> .....	7		
<i>Manual tuning</i> .....	8		
<i>Signal strength display</i> .....	8		
<i>Classic FM button</i> .....	9		
<i>Presetting stations</i> .....	9		
<i>Recalling a preset station</i> .....	10		
<i>System reset</i> .....	11		
<i>Headphone socket</i> .....	12		
<i>Line out socket</i> .....	12		
<i>Display backlight</i> .....	12		
<i>General</i> .....	16		
<i>Specifications</i> .....	16		
<i>Circuit features</i> .....	16		
<i>Mains Supply</i> .....	17		

## Controls (Top)

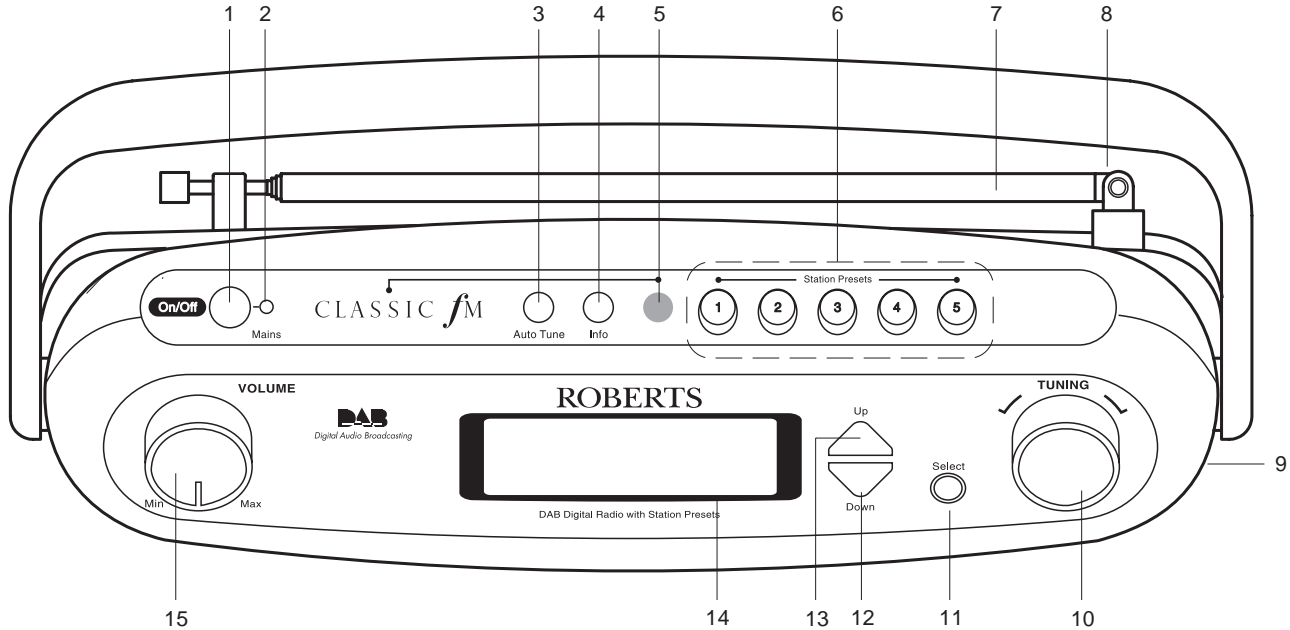

- |                        |                                |                                  |
|------------------------|--------------------------------|----------------------------------|
| 1. On/Off button       | 7. Telescopic aerial (on rear) | 13. Tuning up button             |
| 2. Mains LED indicator | 8. Line out socket (on rear)   | 14. Liquid crystal display (LCD) |
| 3. Auto Tune button    | 9. Headphone socket (on end)   | 15. Volume control               |
| 4. Info button         | 10. Tuning control             |                                  |
| 5. Classic FM button   | 11. Select button              |                                  |
| 6. Station presets     | 12. Tuning down button         |                                  |

If you need any further advice, please call our Technical Helpline on :-  
020 8758 0338 (Mon-Fri)

## Battery operation

1. Remove the **Battery cover** on the rear of the unit by pushing the battery door in and downwards. .
2. Insert six LR14 (C size) batteries into the spaces in the compartment. Take care to ensure all batteries are inserted with the correct polarity as shown inside the battery compartment. Replace the battery cover.
3. Reduced power, distortion and a 'stuttering' sound are all signs that the batteries may need replacing.

4. If the radio is not to be used for any extended period of time it is recommended that the batteries are removed from the radio.  
*We would recommend for economy that the RD-12CFM is used on the mains whenever possible with battery operation for occasional or stand-by use only.*

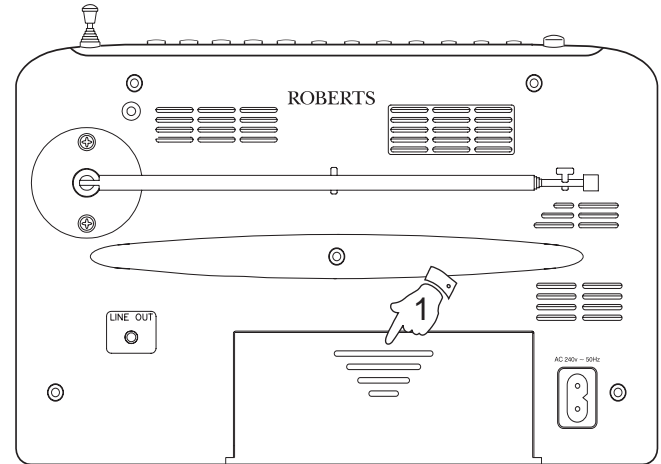

## Mains operation

1. Place your radio on a flat surface.
2. Plug the mains lead into the **Socket** located on the rear of your radio ensuring that the plug is pushed fully into the socket.
3. Plug the other end of the mains lead into a wall socket and switch on the wall socket.

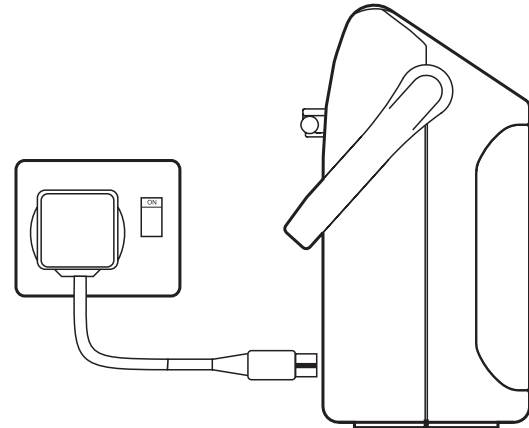

## Operating your radio

1. Fully extend the telescopic aerial
2. Press the **On/Off button** to switch on your radio. The display will show "Roberts DAB digital radio" for a few seconds.
3. If this is the first time the radio is used a quick scan of UK Band III DAB channels will be carried out. The display will show "Autotune Quick scan". If the radio has been used before the last used station will be selected.
4. During Autotune as each group of stations is detected the bottom line of the display will show its name and the station count will be updated. The top line of the display shows a bargraph indicating progress of the Autotune.
5. When the Auto tune is complete the first station (in numeric-alpha order 0...9...A....Z) will be selected.
6. If the station list is still empty after the Autotune you radio will display "No Signal".
7. If no signals are found it may be necessary to relocate your radio to a position giving better reception.



Roberts

Autotune  
Quick scan

■■■■■■■■■■■■■■■■■■■■  
Searching...

■■■■■■■■■■■■■■■■■■■■ 24  
Digital 1 Network

Classic FM DAB  
Digital 1 Network

No signal DAB

## Selecting a station

1. The top line of the display shows the name of the station currently selected.
2. Rotate the **Tuning control** or press the **Up** or **Down buttons** to scroll through the list of available stations.
3. Press and release the **Select button** to select the station. The display may show "Tuning" while your radio finds the new station.
4. Adjust the **Volume control** to the required setting.

Classic FM DAB  
Digital 1 Network

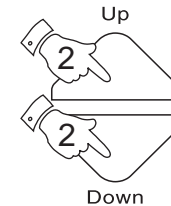
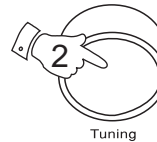

Note: If after selecting a station the display shows "Not Available" it may be necessary to relocate your radio to a position giving better reception.

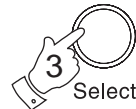

Classic FM DAB  
Tuning...

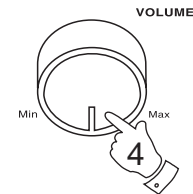

## Secondary services

1. Certain radio stations have one or more secondary services associated with them. If a station has a secondary service associated with it the display will show ">" next to the station name on the station list. The secondary service will then appear immediately after the primary service as you turn the tuning control.

```
BBC5Live>    DAB
■■■■■□■■■■■
```

```
>BBC Sertx   DAB
■■■■■□■■■■■
```

## Display modes

Your radio has five display modes:-



1. Press the **Info button** to cycle through the various modes.

- |                    |   |
|--------------------|---|
| a. Scrolling text  | Displays scrolling text messages such as artist/track name, phone in number, etc. |
| b. Programme Type  | Displays type of station being listened to e.g. Pop, Classic, News, etc.          |
| c. Multiplex Name  | Displays name of multiplex to which current station belongs.                      |
| d. Signal strength | Displays signal strength for station being listened to.                           |
| e. Time and date   | Displays current time and date.   |

a

```
Classic FM   DAB
Jane Jones Pres
```

b

```
Classic FM   DAB
Classical Music
```

c

```
Classic FM   DAB
Digital 1 Network
```

d

```
Classic FM   DAB
■■■■■□■■■■■
```

e

```
Classic FM   DAB
12:02 16-06-2003
```

## Finding new stations

As time passes new stations may become available. To find new stations proceed as follows:-



Autotune  
Quick scan

1. Press and release the **Auto Tune button**, the display will show Autotune Quick scan. Your radio will perform a scan of the UK DAB frequencies. As new stations are found the station counter on the right-hand side of the display will increase and stations will be added to the list

■■■■■■■■■■ 24  
Digital 1 Network

2. To carry out a full scan of the entire DAB Band III frequencies press and hold down the **Auto Tune button** for more than 2 seconds and then release. The display will show Autotune Full scan. As new stations are found the station counter on the right-hand side of the display will increase and stations will be added to the list



Autotune  
Full scan

---

## Autoselect

As an alternative to pressing the **Select button** to select a station your radio can be set so as to automatically select a station.

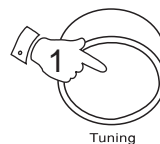

Autoselect ON

1. Rotate the **Tuning control** a few clicks in either direction, immediately press and hold down the **Select button** until the display shows Autoselect ON.
2. Rotate the **Tuning control** or press the **Up or Down buttons** until the station you require is visible on the display. After a few seconds your radio will automatically select the station shown on the display.
3. To switch off autoselect rotate the **Tuning control** a few clicks in either direction, immediately press and hold down the **Select button** until the display shows Autoselect OFF.



Autoselect OFF



## Manual Tuning

Manual tuning allows you to tune directly to the various Band III DAB channels. UK DAB stations are currently located in the range 11B to 12D.

1. Press and hold down the **Select button** until the display shows Manual tune. Release the **Select button**.
2. Rotate the **Tuning control** or press the **Up** or **Down buttons** to select the required DAB channel.
3. Press and release the **Select button** to select the channel.
4. Rotate the **Tuning control** or press the **Up** or **Down buttons** to select the stations contained within the Multiplex (group of stations) for the selected DAB channel.
5. Press and release the **Select button** to return to normal tuning mode.

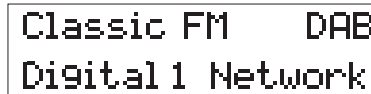
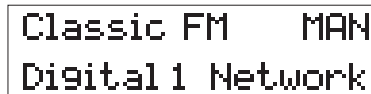
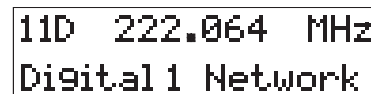
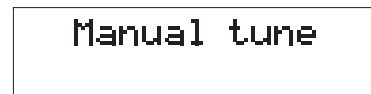
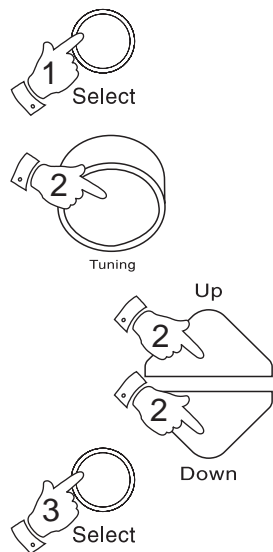

## Signal strength display

1. Repeatedly press and release the **Info button** until the lower line of the display shows signal strength.
2. Position your radio and angle the telescopic aerial for best reception using the signal strength display as guide. Move your radio around and position so as to give maximum number of black rectangles on signal strength display.
3. The clear unfilled rectangle indicates minimum signal level required for satisfactory reception.



If you need any further advice, please call our Technical Helpline on :-  
020 8758 0338 (Mon-Fri)

## Classic FM button

Your radio is fitted with a button which when pressed will automatically tune your radio to Classic FM.

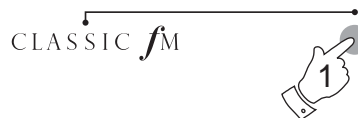

1. Press the **Classic FM button**.
2. Your radio will automatically tune to Classic FM.

Classic FM DAB  
Digital 1 Network

Note: If Classic FM is not available in your area the display will show "Not Found"

---

## Presetting stations

There are 5 memory presets.



1. Press the **On/Off button** to switch on your radio.
2. Tune to the required station as previously described.
3. Press and hold down the required **Preset button** until the display shows e.g. Preset 1 stored. The station will be stored under the chosen preset button. Repeat this procedure for the remaining presets.
4. Stations stored in preset memories may be overwritten by following the above procedure.

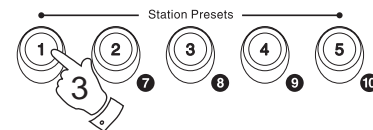

Planet Rock DAB  
Preset 1 stored

## Recalling a preset station

1. Press the **On/Off button** to switch on your radio..
2. Momentarily press the required **Preset button**, your radio will tune to the station stored in preset memory.

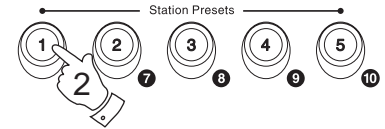
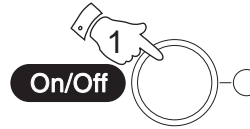

Planet Rock DAB  
Digital 1 Network

## System reset

If your radio fails to operate correctly, or some digits on the display are missing or incomplete carry out the following procedure.

1. Switch off your radio
2. Switch on your radio - as soon as the screen shows Roberts DAB digital radio press and hold down the **Select button** until the display shows System Reset.
3. A full reset will be performed and all presets and station lists will be erased.
4. A Quick scan will then be performed.

If a problem persists our technical staff would be pleased to help offer any assistance on operating the radio. Our technical helpline number is 020 8758 0338.



System reset

Autotune  
Quick scan

■■■■■■■■■■  
Searching...

■■■■■■■■■■ 24  
Digital 1 Network

## Headphone socket

A 3.5mm **Headphone Socket** located on the right-hand end of your radio is provided for use with either headphones or an earpiece. Inserting a plug automatically mutes the internal loudspeaker.

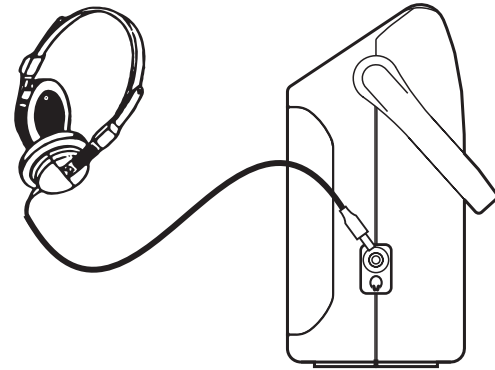

## Line out socket

A 3.5mm **Line out socket** located on the rear of your radio is provided for connecting the audio signal to an external amplifier. Inserting a line out audio cable will not mute the internal loudspeaker. Set the volume control to minimum if desired.

## Display backlight

1. The display backlight will be switched on for approximately 12 seconds when any button is pressed.
2. When your radio is powered by AC mains the display backlight will always be switched on.

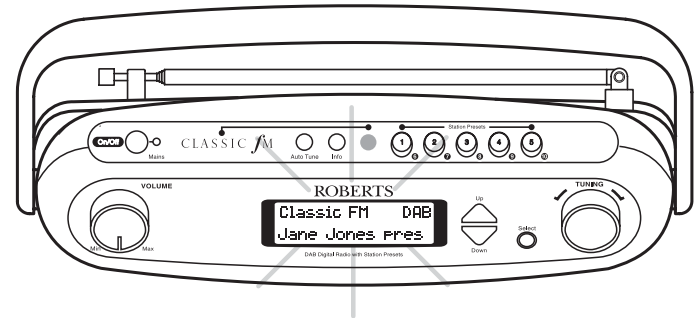

## General

Do not allow this radio to be exposed to water, steam or sand. Do not leave your radio where excessive heat could cause damage such as in a parked car where the heat from the sun can build up even though the outside temperature may not seem too high.

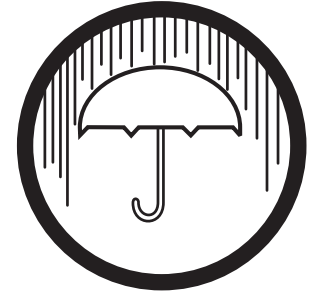
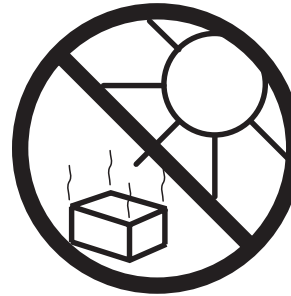

---

## Specifications

### Power Requirements

Mains AC 230 volts, 50Hz  $\sim$  only  
Batteries 6 x LR14 (C size)

### Battery Life

Approx. 17 hours of listening for 4 hours a day at normal volume using alkaline cells.

### Frequency Coverage

DAB 174.928 - 239.200MHz

## Circuit Features

Loudspeaker	92mm 4ohms
Output Power	3W into 4ohms
Headphone socket	3.5mm dia
Aerial System	Telescopic aerial

## Mains supply

The RD-12CFM will operate from a supply of AC 230 volts, 50Hz  $\sim$  only.

**DO NOT cut off the mains plug from this equipment.** If the plug fitted is not suitable for the power points in your home or the cable is too short to reach a power point, then obtain an appropriate safety approved extension lead or adaptor. If in doubt consult your dealer.

If nonetheless the mains plug is cut off, remove the fuse and dispose of the plug immediately to avoid a possible shock hazard by inadvertent connection to the mains supply.

If this product is not supplied with a mains plug, or one has to be fitted, then follow the instructions given below:

**IMPORTANT. DO NOT** make any connection to the larger terminal which is marked with the letter E or by the safety earth symbol  $\perp$  or coloured Green or Green-and-yellow.

The wires in the mains lead are coloured in accordance with the following codes :-

BLUE - NEUTRAL

BROWN - LIVE

The wire coloured BLUE must be connected to the terminal marked N or coloured BLACK.

The wire coloured BROWN must be connected to the terminal marked L or coloured RED.

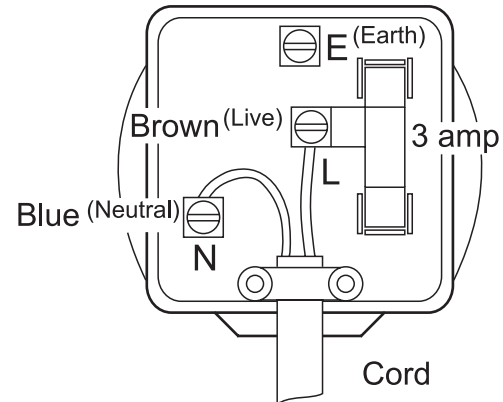

## Fuse

When replacing the fuse only a 3A ASTA approved to BS1362 type should be used and be sure to re-fit the fuse cover.

IF IN DOUBT - CONSULT A QUALIFIED ELECTRICIAN.

Replacement fuse holders are available from Roberts Radio Technical Services at the address shown on the rear of this manual.

## Guarantee

This instrument is guaranteed for twelve months from the date of delivery to the original owner against failure due to faulty workmanship or component breakdown, subject to the procedure stated below. Should any component or part fail during this guarantee period it will be repaired or replaced free of charge.

The guarantee does not cover:

1. Damage resulting from incorrect use.
2. Consequential damage.
3. Receivers with removed or defaced serial numbers.

N.B. Damaged or broken telescopic aerials will not be replaced under guarantee.

Procedure:

Any claim under this guarantee should be made through the dealer from whom the instrument was purchased. It is likely that your Roberts' dealer will be able to attend to any defect quickly and efficiently, but should it be necessary the dealer will return the instrument to the company's service department for attention. In the event that it is not possible to return the instrument to the Roberts' dealer from whom it was purchased, please contact Roberts Radio Technical Services at the address shown below.

### ROBERTS RADIO TECHNICAL SERVICES

97-99 Worton Road  
Isleworth Middlesex

TW7 6EG

Technical Helpline :- 020 8758 0338 (*Mon-Fri during office hours*)

