



COBRA Video

DVC5200

Owner's Instruction Book

Before operating the unit, please read this instruction book thoroughly, and retain it for future reference.

www.cobradigital.com

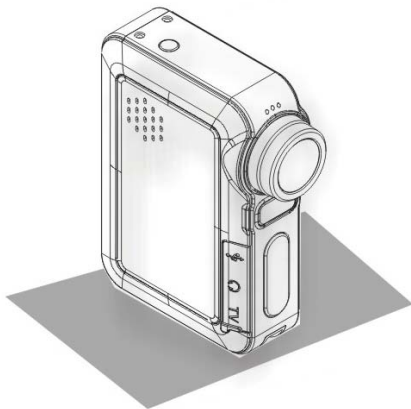

Content of table

Introduction.....	4
Overview	4
Features	4
Package Content.....	4
Getting to know Your Camcorder	5
Preparation.....	6
Battery Installation.....	6
Charging the Lithium Battery	7
Inserting an optional Memory Card	7
How to use the LCD monitor	8
Power on/off your Digital Video	9
The Mode Dial Menus	10
OSD in CAMERA mode.....	11
System Setup	13
Take a Video	19
Take Photos	23
Advanced operation	25
Other Function.....	29

Recording audio files	29
Mp3 Player	30
PLAYBACK Mode	31
Video Clip playback.....	31
Still images playback.....	31
Display on TV	32
Playing audio file	32
Software Installation	35
Downloading.....	36
Copy Mp3 files from PC to your DV.....	38
Video impression Application	39
Web Cam	46
Video Conference.....	46
Chat with MSN	47
Print Photos.....	50
Troubleshooting.....	51
Specifications	53

Introduction

Overview

Thank you for purchasing the Cobra Digital Video Camera DVC5200. It can not only take video but can also be used as a Digital Still camera, audio recorder, MP3 player, MP4 player, webcam, media player, mass storage, TV out and card reader. Generally, this multi-functional DVC5200 camera will make your life more colorful and enjoyable.

Features

- Effective resolution: 2592 x 1944 Mega Pixels, interpolated up to 10M pixels.
- 9 in 1- Digital Video, Digital Still Camera, MP3, MP4, AUDIO REC, WEB CAM, MEDIA PLAYER, MASS STORAGE, CARD READER
- 2.0" LTPS TFT Full Color LCD
- 4x Digital zoom
- Internal DDR (16MB), 32MB NAND FLASH MEMORY
- External SD/MMC Card slot for adding optional SD card memory (available at almost all stores that sell electronic products.
- USB 2.0 transmission interface

Package Content

Software CD	User's manual	AV cable (TV connection)	Lithium Battery	USB cable
Earphone	Pocket	Strap	Charger	

Getting to know Your Camcorder

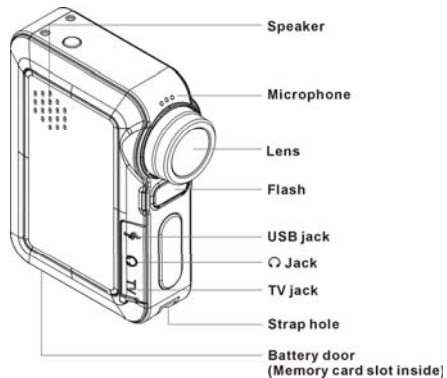
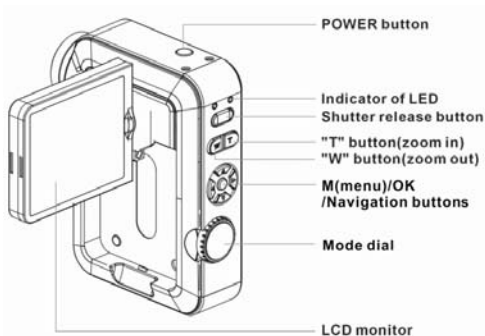

Preparation

Battery Installation

Your DV requires lithium battery (3.7V). To insert the battery in the camcorder:

1. Slide the battery bolt to open battery door.
2. Load the lithium battery correctly as the polarity (+ and -) marked on the battery cover.
3. Close battery door.

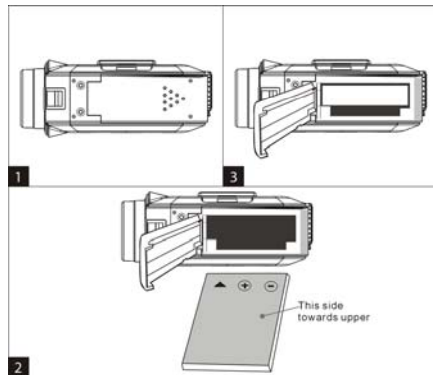

Notes: If you do not intend to use the device for a long time, remove the battery from your DV.

Charging the Lithium Battery

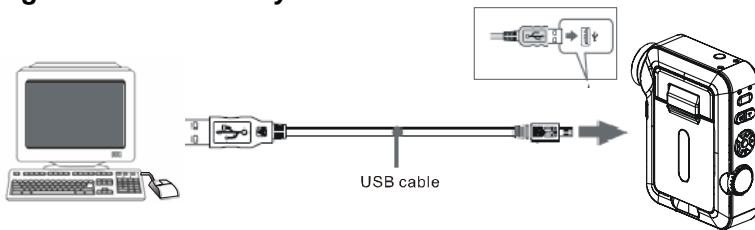

1. Attach the battery pack to the camcorder.
2. Power off your DV and connect it to PC with USB cable correctly.
3. The charging indicator will be turned to blue, showing that the battery is charging.
4. When the battery is fully charged, disconnect the PC from the camcorder.

Notes: When the battery is fully charged, the indicator will turn off.

Inserting an optional Memory Card

You can insert any “SD” compatible memory card before using. Adding a memory card will allow you to increase the capacity of your DV. Please push the card firmly into the slot as far as it will go until you hear “click” sound.

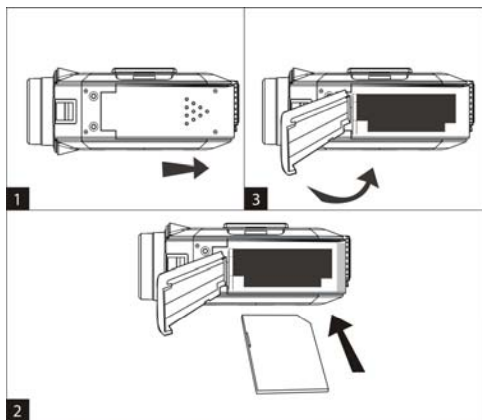

How to use the LCD monitor

1. Open the LCD monitor.
2. Rotate the LCD screen carefully per your request.

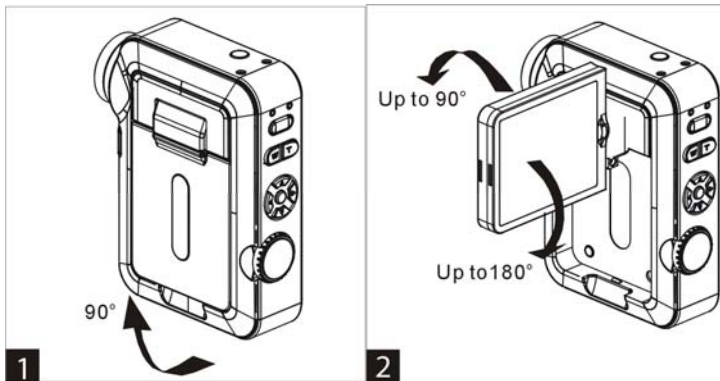

Notes:

1. Over rotation may cause damage to the inside of the hinge that connects the LCD screen to the Camcorder.
2. Please don't contact the surface of screen when you rotate the LCD.
3. When the LCD keeps same direction with digital lens, the image shown on LCD will be adjusted automatically.

Power on/off your Digital Video

Press the **POWER** button to start your DV, and the LCD Monitor will light up, showing your DV is ready to use. Under the DV is "ON", press **POWER** again button to turn off the device.

The Mode Dial Menus

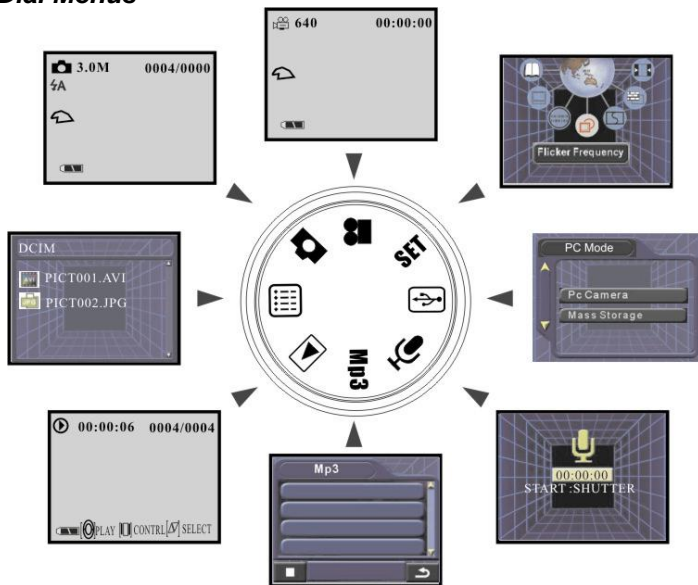

OSD in CAMERA mode

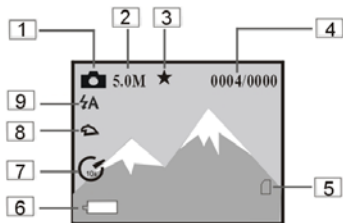

1. Capture Mode

 Single shoot

 Sequence

2. Resolution

10M (3648x2736) 7M (3072x2304) 5M (2592 X1944) 3M (2048 X1536) 1M (1280 X 960)

3. Photo Quality

★ Normal quality

★★ Fine

★★★ Super quality

4. Number of video/audio files Taken

5. The icon of inserting SD card

6. Battery level

 Full

 Medium

 Low

7. Self Timer

 10s self timer

 20s self timer

8. White Balance

AWB Auto

 Daylight

 Tungsten

 Fluoresce

 Cloudy

9. Flash Mode

 Force On

 Auto

 Force Off

 Red Eye Reductions

System Setup

Rotate dial mode to select “**SET**” mode. (The arrow points at “**SET**” position).

Set Frequency

1. Rotate dial mode to select “**SET**” mode.
2. Press ◀/▶ button to select “**Frequency**” and then press **M** button.
3. Press ▲/▼ button to set the frequency, and press **M** button to confirm.

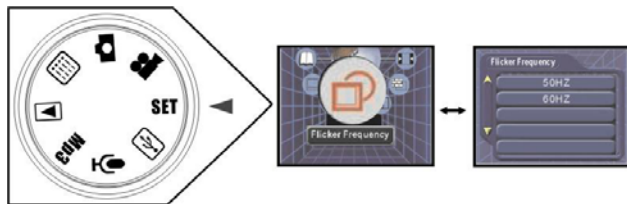

Date/Time Set

1. Rotate dial mode to select “**SET**” mode.
2. Press ◀/▶ button to select “**Time**” and then press **M** button.
3. Press ◀/▶ button to select the digit.
4. Press ▲/▼ button to set the digit.
5. Press **M** button to confirm.

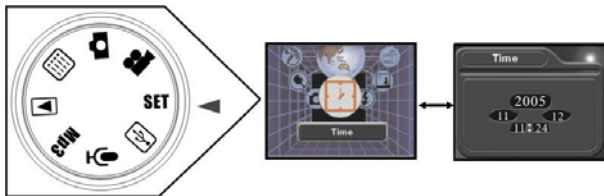

Beep Sound

Select a beep sound whenever you change a setup value.

1. Rotate dial mode to select “**SET**” mode.
2. Press ◀/▶ button to select “**Beep**” and then press **M** button.
3. Press ▲/▼ button to select “**On**” or “**Off**”, and press **M** to confirm.

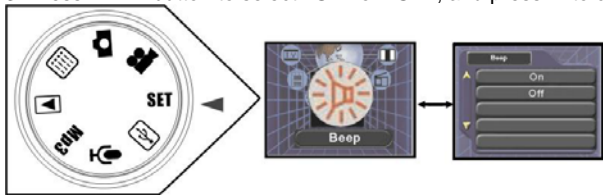

Note: . The BEEP SOUND function works in CAMERA, PLAYER, M.REC, and M.PLAY modes.

. When beep is on, you can hear a “beep” sound with your operating.

Format

1. Rotate dial mode to select “**SET**” mode.

2. Press **◀/▶** button to select **“Format”** and then press **M** button.
3. Press **▲/▼** button to select **“Yes”** or **“No”**, and press **M** to confirm.

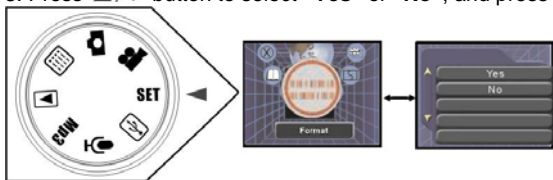

- Notes:**
1. At step 3, select **“Yes”**, all files in flash memory will be erased; After inserting SD/MMC card, If you select **“Yes”**, either all files in flash memory or external card will be deleted, depending on your selection of media.
 2. Formatting will erase all files, even if the files are locked.

Media Select

1. Rotate dial mode to select **“SET”** mode.
2. Press **◀/▶** button to select **“Media Select”** and then press **M** button.
3. Press **▲/▼** button to select **“Internal Flash”** or **“External Card”**, and press **M** to confirm.

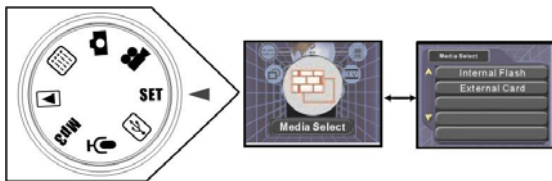

Note: The photos will be stored in the device you have selected. The default is Internal Flash storage.

Default Setting

1. Rotate dial mode to select “**SET**” mode.
2. Press ◀/▶ button to select “**Default Setting**” and then press **M** button.
3. Press ▲/▼ button to select “**Yes**” or “**No**”, and press **M** to confirm.

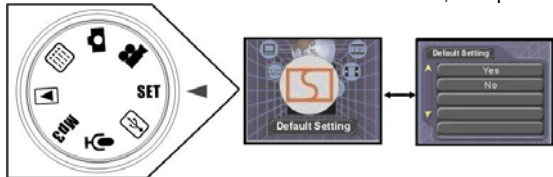

Language Select

1. Rotate dial mode to select “**SET**” mode.
2. Press ◀/▶ button to select “**language**” and then press **M** button.
3. Press ▲/▼ button to select the language what you want and press **M** to confirm.

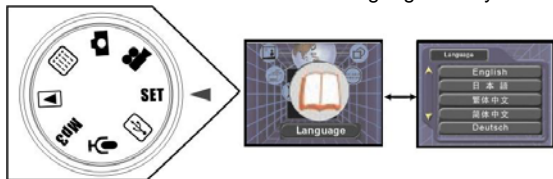

Power Save

1. Rotate dial mode to select "SET" mode.
2. Press ◀/▶ button to select "Power Save" and then press M button.
3. Press ▲/▼ button to select the time that power auto off (60Sec, 2min, or None) and press M button to confirm.

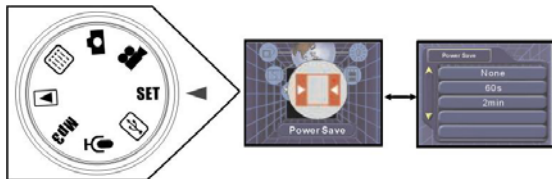

TV Mode

1. Rotate dial mode to select "SET" mode.
2. Press ◀/▶ button to select "TV Mode" and then press M button.
3. Press ▲/▼ button to select the TV mode (NTSC or PAL), and press M button to confirm.

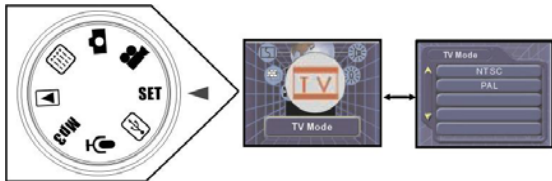

Logo Display

1. Rotate dial mode to select “**SET**” mode.
2. Press ◀/▶ button to select “**Logo Display**” and then press **M** button.
3. Press ▲/▼ button to select “On” or “Off”, and press **M** button to confirm.

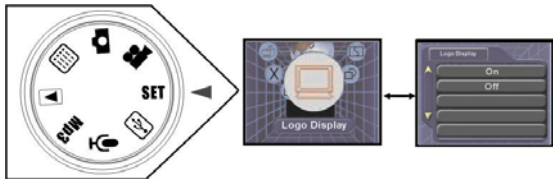

Version

1. Rotate dial mode to select “**SET**” mode.
2. Press ◀/▶ button to select “**Version**”.
3. Press **M** button to check the current Version of your Digital Video
4. Press **M** button to exit Version menu.

Take a Video

Rotate dial mode to select “**Normal**” mode of the DV. (The arrow points at “**Normal**” position).

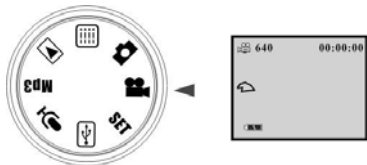



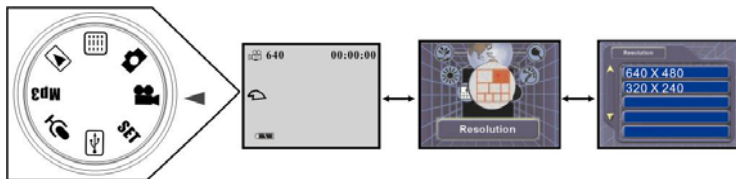

Set Resolution

1. In VIDEO mode, Press **M** button, the LCD will show as below.
2. Press **◀/▶** button to select “**Resolution**” and press **M** button.
3. Press **▲/▼** button to select “**640 X 480**” or “**320 X 240**” and then press **M** button to confirm.
4. Press **▼** button to exit the menu and return to the normal mode.





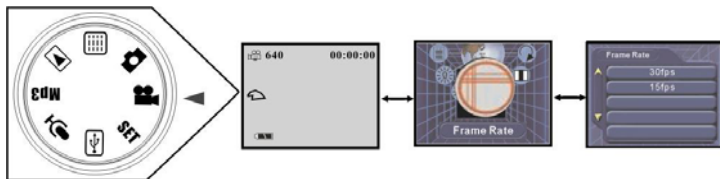

Frame Rate

1. In  mode, Press **M** button, the LCD will show as below.
2. Press  button to select “**Frame Rate**” and press **M** button.
3. Press  button to select “**30fps**” or “**15fps**” and then press **M** button to confirm.
4. Press  button to exit the menu and return to the normal mode.



Set Audio

1. In  mode, Press **M** button, the LCD will show as below.
2. Press  button to select “**Audio**” and press **M** button.
3. Press  button to select “**On**” or “**Off**” and then press **M** button to confirm.
4. Press  button to exit the menu and return to the normal mode.

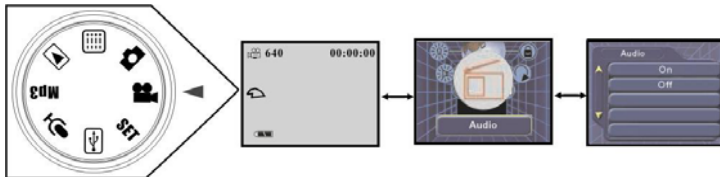

White Balance

Please refer to the operation (white balance) in  mode.

Take a Video

1. Press the **POWER** button to start the DV.



2. Rotate the LCD monitor to best angle (The scope of rotation is 0° -270°).

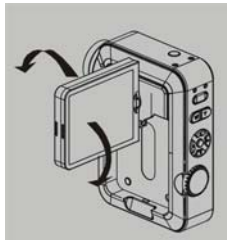

3. Rotate dial mode to select “” mode.

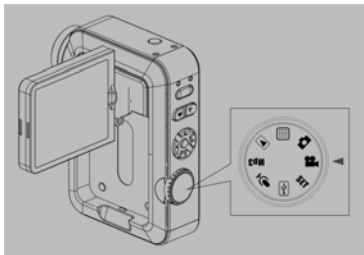

4. Use the LCD monitor to find the things. Hold the digital video steadily, and press the **Shutter** Button to start taking a video.

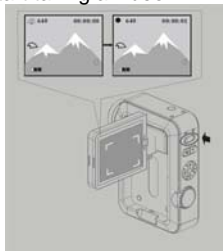

5. Press the **Shutter** Button again to stop taking a video.

Zoom In /Out

During shooting, you can press **T** button to zoom in up to 4x and **W** to zoom out.

- Notes:**
1. The video clips will be saved as MPEG 4 format.
 2. The shooting time varies depending on the available space of memory card.

Take Photos

Rotate dial mode to select “**Normal**” mode of the camera. (The arrow points at “” position).

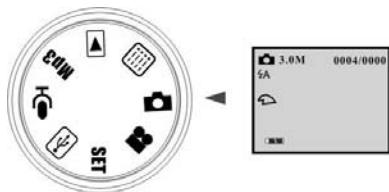

Simply take a Photo

1. Press the **POWER** button to start the DV.

2. Rotate the LCD monitor to select best angle. (The scope of rotation is 0° -270°).

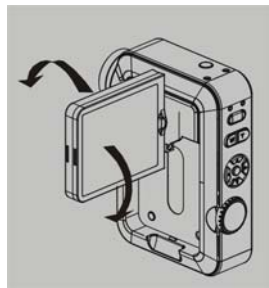

3. Rotate dial mode to select “” mode.

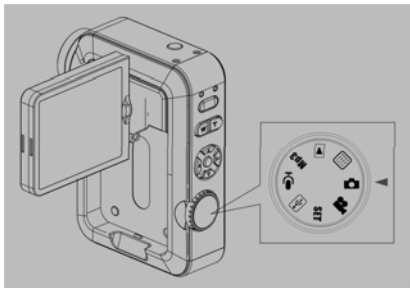

Note:

1. You can press “**T**” button to zoom in up to 4x during taking photo.

2. When the DV is fully loaded with photos, if you press **Shutter** Button again, “**No Space**” will be shown on LCD monitor.

4. Use the LCD monitor to find the things for which you desire to take photos.



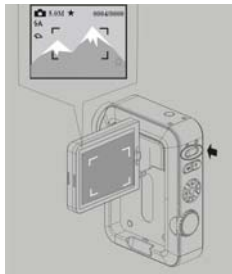

5. Hold the digital video steadily, and press the **Shutter** button to take photos.



Advanced operation

Flash Function

In “Normal” mode of 

1. Repeatedly press **▲** button to select the icon  shown on LCD. The flash function is forced on.
2. Repeatedly press **▲** button to select the icon  shown on LCD. The automatic flash function is activated.
3. Repeatedly press **▲** button to select  shown on LCD. Flash function is not available.
4. Repeatedly press **▲** button to select the icon  shown on LCD. **IGBT** function is ready.

Meanwhile, you can also set flash function as the following operation

1. In CAMERA mode, Press **M** button.
2. Press **◀/▶** button to select “Flash Mode” and press **M** button.
3. Press **▲/▼** button to select flash mode, and then press **M** button to confirm.
4. Press **▼** button to exit the menu and return to the normal mode.

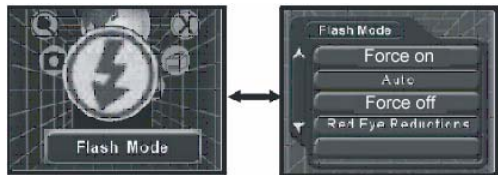



Continuous/Self-timer Shoot

In “Normal” mode of 

1. Repeatedly press **▼** button to select the icon  shown on LCD. Press **Shutter** button, the timer

runs for 10s before the photo is taken.

2. Repeatedly press ▼ button to select the icon  shown on LCD. Press **Shutter** button, the timer runs for 20s before the photo is taken.
3. Repeatedly press ▼ button to select the icon  shown on LCD. Press **Shutter** button, three photos will be taken at one time.

Meanwhile, you can also achieve the above as below:

1. In CAMERA mode, Press **M** button.
2. Press ◀/▶ button to select “**Capture Mode**” and press **M** button.
3. Press ▲/▼ button to select the mode of capturing and then press **M** button to confirm.
4. Press ▼ button to exit the menu and return to the normal mode.

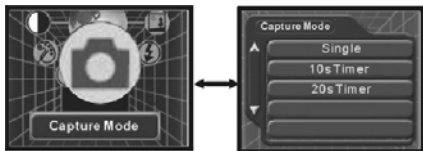

Date on Photo

1. In  mode, Press **M** button, the LCD will show as below.
2. Press ◀/▶ button to select “**Date Stamp**” and press **M** button.
3. Press ▲/▼ button to select “**On**”, and then press **M** button to confirm.
4. Press ▼ button to exit the menu and return to the normal mode.
The date will be printed on the photo taken.

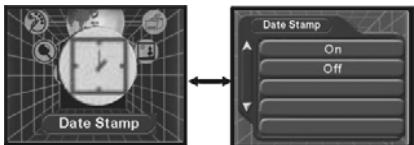

EV Set

1. In CAMERA mode, Press **M** button, the LCD will show as below.
2. Press **◀/▶** button to select “**EV**” and press **M** button.
3. Press **▲/▼** button to set EV digit (-2.0 ~ +2.0) per your request.
4. Press **M** button to confirm.
5. Press **▼** button to exit the menu and return to the normal mode.

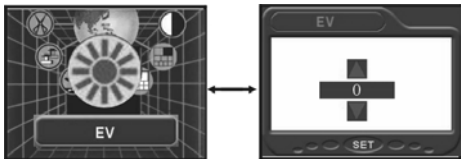

White Balance

1. In **CAMERA** mode, Press **M** button, the LCD will show as below.
2. Press **◀/▶** button to select “**White Balance**” and press **M** button.
3. Press **▲/▼** button to select “**Auto**”, “**Daylight**”, “**Tungsten**”, “**Fluoresce**” or “**Cloudy**” per your request, and then press **M** button.

4. Press ▼ button to exit the menu and return to the normal mode.

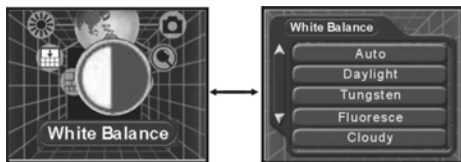

Image Quality

1. In CAMERA mode, Press **M** button, the LCD will show as below.

2. Press ◀/▶ button to select **“Quality”** and press **M** button.

3. Press ▲/▼ button to select **“Super”**, **“Fine”**, or **“Normal”** per you request, and then press **M** button.

4. Press ▼ button to exit the menu and return to the normal mode.

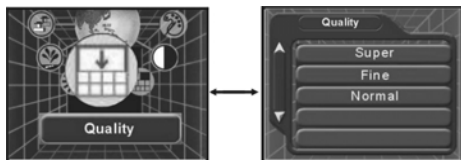

Note: The resolution and quality will be shown on the LCD.

Resolution

1. In CAMERA mode, Press **M** button, the LCD will show as below.

2. Press ◀/▶ button to select **“Resolution”** and press **M** button.

3. Press ▲/▼ button to select the image size, and then press **M** button.
4. Press ▼ button to exit the menu and return to the normal mode.

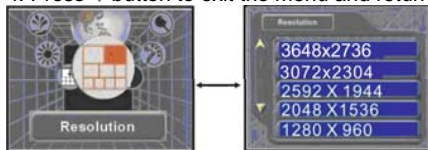

Other Function

In CAMERA mode, you can set some others function excluding the above: “**Scenery**”, “**Color**”. Please refer to the above operation.

Recording audio files

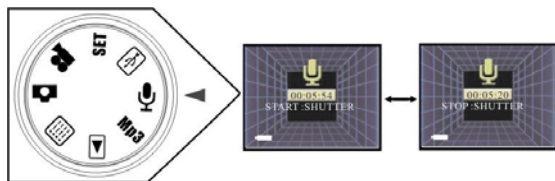

1. Press **POWER** button to start digital video.
2. Rotate dial mode to make the arrow point at “**U**” position.
3. Press **Shutter** button to start recording, and press **Shutter** button again to stop recording. You can play this audio file in Playback mode.



- Notes:**
1. The recording time varies depending on the available space of memory.
 2. The audio file that you record will be saved as WAV format.
 3. When playing these audio files under PLAYBACK mode, you can press ◀/▶ button to adjust volume per your request.

Mp3 Player

Before playing, please download some Mp3 files from your PC to this device.

1. Press **POWER** button to open digital video.
2. Rotate dial mode to make the arrow point at “**Mp3**” position.
3. Press ▲/▼ button to select the Mp3 file that you want to play, and press ◀/▶ button to adjust the volume.
4. Press **Shutter** button to start, press **Shutter** button again to stop playing.
5. There are three kinds of playing mode in mp3 player. Press **M** button to select the icon  shown on LCD, showing the mp3 files will be played in cycle; Press **M** button to select the icon  shown on LCD, and the selected mp3 will be played repeatedly; Press **M** button to select the icon  shown on LCD, showing the mp3 files will be played in sequence.

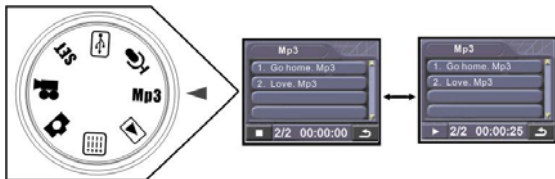

PLAYBACK Mode

Rotate dial mode to select “**PLAYBACK**” mode. (The arrow points at “▶” position).

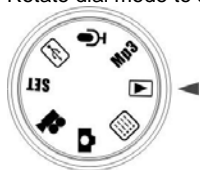

Video Clip playback

In **PLAYBACK** mode, the video clip with audio can be played.

1. Power on your digital video.
2. Rotate dial mode to select “**PLAYBACK**” mode. (The arrow points at “▶” position).
3. Press ▲/▼ button to select the clip that you want to play.
4. Press **Shutter** button to play the video clip. Press **Shutter** button again to pause playing, and then press this button to continue playing.

Still images playback

In **PLAYBACK** mode, you can browse the photos in full-screen (or thumbnail mode, zoom in mode, slideshow).

1. Power on your digital video.
2. Rotate dial mode to select “**PLAYBACK**” mode. (The arrow points at “▶” position).

3. Press ▲/▼ button to select the photo that you want to view.
 - **Digital Zoom:** You can press **T** to zoom in the photo up to 4 x;
 - **Thumbnail Mode:** Press ◀ button to make all files in memory shown in thumbnails, press **M** button to exit thumbnail view mode.
 - **Slideshow:** 1. Press **M** button. Press ◀/▶ button to select “**Slide show**”.
 2. Press **M** button.
 3. All photos will be played in slideshow mode, press **Shutter** button to pause and press ◀ to exit.
 - **Rotation:** Press **M** button and then press ◀/▶ button to select” **Rotate**” and then press **M** button. Press ▲/▼ button to select scope of rotation. Press **M** button to save the picture after rotation. Press ◀ button to exit the rotation mode if you don't want to rotate the picture now.

Display on TV

The photos and video clip can be played on TV. Before connecting, you must select the suitable TV mode (NTSC or PAL) in your DV.

1. Connect DV to TV with AV cable correctly.
2. Power on your DV and TV (AV mode).
3. You can use TV LCD instead of your DV LCD.

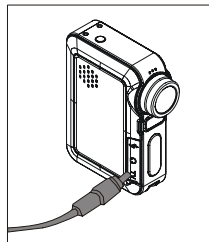

Playing audio file

1. Power on your digital video.
2. Rotate dial mode to select “**PLAYBACK**” mode. (The arrow points at “▶” position).
3. Press ▲/▼ button to select the audio files (wav) that you want to play.
4. Press **Shutter** button to play the audio files.
5. Press **Shutter** button again to stop playing.

Note: You can press ◀/▶ to adjust volume of audio files per your request when playing.

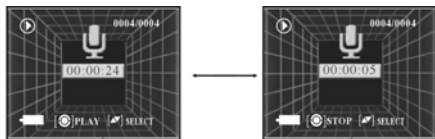

The length of playing time

The left time

Delete All/Single

1. In **PLAYBACK** mode, press **M** button.
2. Press ◀/▶ button to select “**Delete**” and press **M** button.
3. Press ▲/▼ button select to “**Delete Current**”, and then press **M** button.
4. Press the ▲/▼ button select to “**Yes**” and then press **M** button, the current file is deleted; If you select “**Delete All**”, all files (exclude the locked files) in memory will be deleted at one time.



Notes: If you select “**Delete All**”, either all files in flash memory or external card will be deleted, depending on your selection of media. All files in **PLAYBACK** mode exclude MP3 files.

Protect Video clips/Photos

1. In **PLAYBACK** mode, press **M** button.
2. Press ◀/▶ button to select “**Lock**” and press **M** button.
3. Press ▲/▼ button select to “**Lock Current**”, and then press **M** button. The current file is locked; If you select “**Lock All**”, all files in memory will be protected.
4. Press ▼ button to exit the menu and return to the Playback mode.

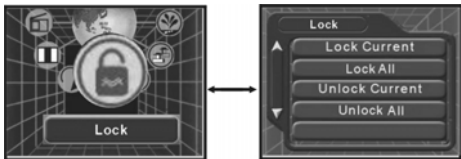

Notes:

- . At step 3, if you select “**Unlock Current**” or “**Unlock All**”, the relative protection will be canceled.

Crop the Photo

1. In **PLAYBACK** mode, press **M** button.
2. Press ◀/▶ button to select “**Crop**” and press **M** button.
3. Press ◀/▶/▲/▼ button to select the part that will be remaining. Then press Shutter button to view the area you have cropped in full screen.
4. Press Shutter button again to save it as new image file or press **M** button to exit without saving the cropping area.

Note: if the file you delete is locked, a “File Protect” will appear on the LCD.

Software Installation

Please put the software CD in your computer. Choose the right language per your request. This will launch the Video impression software installation. Follow the directions appear on your screen.

Step 1: Select language



Step 2: Install VideoImpression

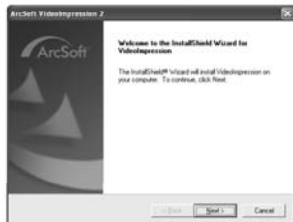

Step3: Install DirectX9

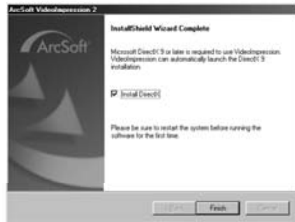

NOTE:

- Do not connect the DV to your computer during installing software.
- Please check the “Install DirectX”, which support playing video files.

If your computer can't install automatically, please install manually as the following steps.

1. Place the CD into your CD-ROM drive.
2. Click right key at the CD-ROM drive, then click `open\autorun.exe`.
3. Follow the directions of the installation wizard.

Downloading

Before downloading, please rotate mode dial to select  (PC mode), and then press **▲/▼** button to select " **Mass Storage**".

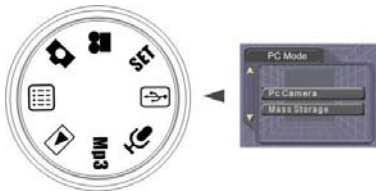

Transfer still images/video files from DV to your PC

Connect the DV to computer with the USB cable.

1. Double-click the icon **My Computer**.
2. Double-click the icon **MASS STORAGE**.
3. Double-click **DCIM** icon.
4. Double-click **100NVTIM** icon.
5. You can now copy and paste the images to any directory you choose.

Notes:

There can be still images, video files (mp4 format) and audio files (wav format) in the file named "100 NVTIM".

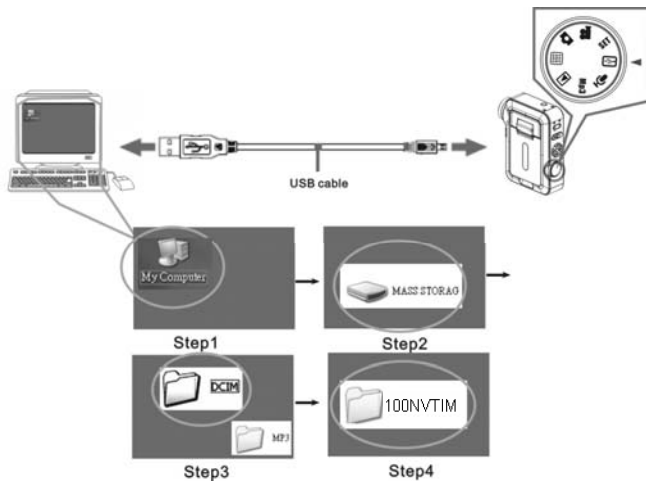

Copy Mp3 files from PC to your DV

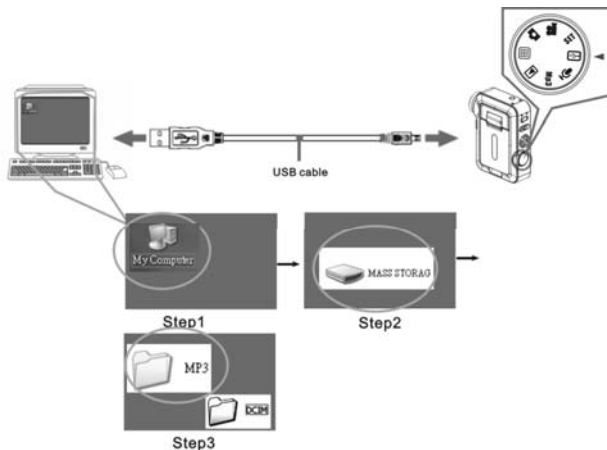

1. Double-click the icon **My Computer**.
2. Double-click the icon **MASS STORAGE**.
3. Double-click **MP3** icon. You can now copy and paste mp3 files to it.

Video impression Application

Video impression software is a tool for producing custom movies and slide shows using your own video clips, picture, and sound tracks. There are 6 steps to achieve producing wonderful movies.

1. Media



1. On the main interface of this software, click the icon  to select files.

2. To our DV, there are two ways to get the video clips, audio files or photos.

Select files directly from the DV

For your DV, In PC Mode, you select “**Mass Storage**”, and then connect DV to PC with USB cable. The flash memory will be used as a movable hard disk on your computer, and you can select files from it.

Select files from memory card

You can also select files directly from a memory card.

3. Add items from your albums to the Storyboard, and they will combine to create your final movie or slide show.

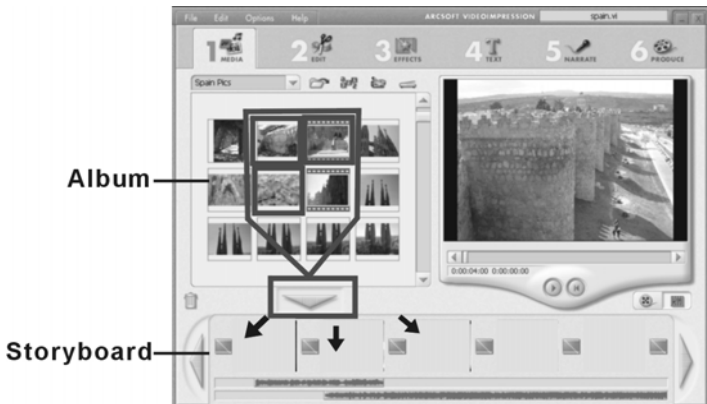

2. Edit

This step is only available for video projects and not slide shows. It lets you adjust the brightness and contrast of still images and videos on the Storyboard. You can also set the display time for still images and "trim" audio and video files to play only the sections that you want.

Set Brightness
Set Contrast
Duration



3. Effects

Here you may add special effects that occur as one component on the Storyboard changes to the other. You may either add these “transitions” manually, or apply a “theme” to your entire project.



4. Text

You can add text to any video or still image on the Storyboard. Text can appear stationary or move about the screen in various ways. This step is only available for video projects. Meantime, you can set the font, size, color, and shadow of text.



5. Narrate

This step is labeled as "Audio" when working on a slide show project. Here you may record audio tracks and add them to the Storyboard. You can include as many audio tracks as you like, with two playing back simultaneously at any given time. Because your videos may already have sound, you may actually have a total of three tracks playing at once.

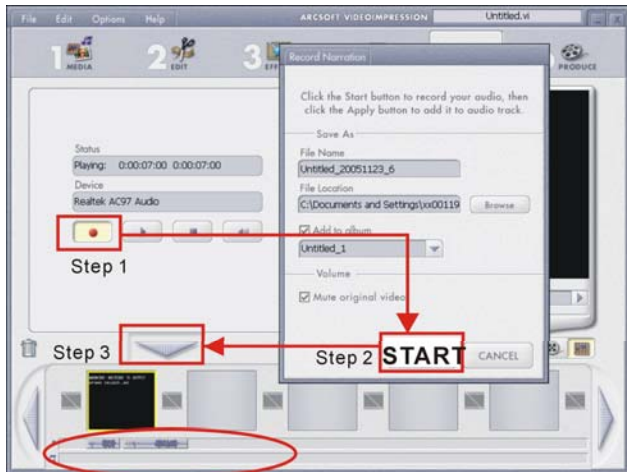

Audio tracks

6: Produce

The final step saves your project. When you're finished with this step, everything on the Storyboard will be combined into your video or slide show. Options here will vary depending on the type of project you make. Video projects will have more save options (tabs) than slide show projects. Some versions of the program will allow you to save to DVD.



Web Cam

Video Conference

Your DV can be used as a PC camera to conduct image transmission or hold online videoconference

1. Connect the camera to your computer with USB cable correctly.
2. Select <My Computer>\<Local Disk(c:)>\<Program Files>\<NetMeeting>, and then run the videoconference software Microsoft NetMeeting on your computer according installation instruction.

1. Double-click the icon "NetMeeting" in your computer.

2. Select "Place A Call"

3. Input others' IP address, then click "call"

4. Select [Tool]\[Video]\[Send] and [Transfer] options after others received your calling, you can hold video conference now.

Chat with MSN

Your DV can be used as a PC camera when you are chatting with your friends with MSN

1. Rotate mode dial to select PC mode, and then press ▲/▼ button to select “PC Camera”.
2. Run and sign in the MSN software on your computer.
3. Connect the camera to your computer with USB cable correctly.

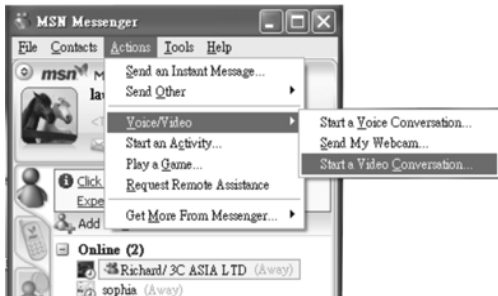

4. On the main interface of MSN, you select [Actions]Voice/Video] [Start a Video Conversation] in sequence.



5. Select the person who you want to chat and then press “OK”.

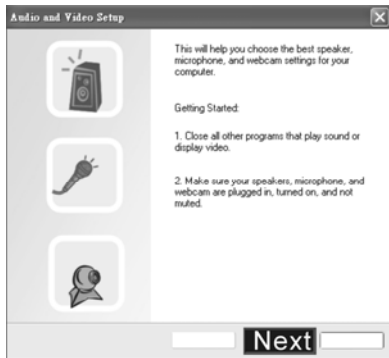

6. Press "Next" to continue.

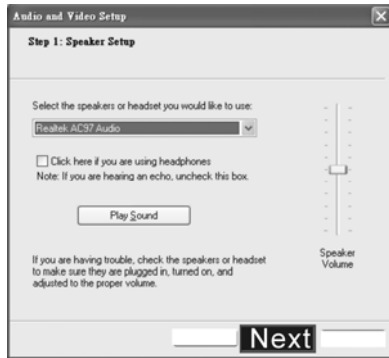

7. You can select speaker and adjust speaker volume, and then press "Next" to continue.

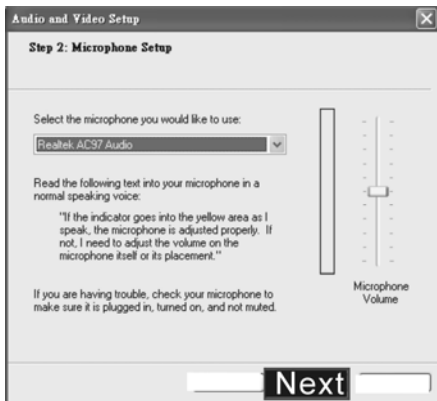

8. You can select Microphone and adjust Microphone volume, and then press "Next" to continue.
 9. Press "Finish" to finish setting.
- Now, you can chat with your friends with webcam.

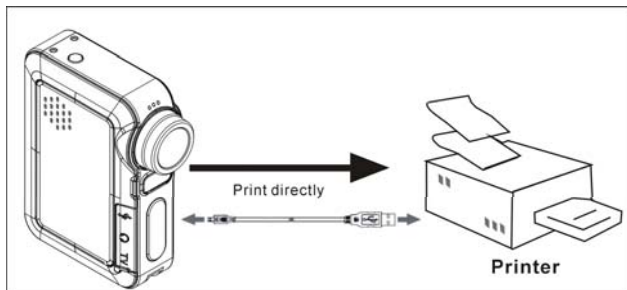

Print Photos

If there is a printer, which supports PictBridge function in home or office, you can connect DV to your printer with USB cable directly.



1. Power on your printer.
2. Power on your DV.
3. Rotate your DV to  mode to select a photo you want to print.
4. Press **M** button and then **◀/▶** to select **Print** on LCD.
5. Connect DV to your printer with USB cable directly.
6. Press **◀** to cancel and **▶** to start printing.
7. You can press **▲/▼** to have a setting relative to the printing.

Troubleshooting

Relative parts	Symptom	Explanation/Solution
Taking video/photos	The DV can't take video/photos after you press Shutter button.	<ul style="list-style-type: none"> .The battery level is too low and you can charge it in time. .The DV is not in /  mode. Please rotate dial mode to the correct position. . Auto Power off. Restart your device. . The flash memory or SD card is fully loaded with files. Please delete some useless files or change an memory card.
Auto Power off	The camcorder goes off automatically.	<ul style="list-style-type: none"> .You have left the camcorder set to STBY for more than 60s or120s without using it. .The battery pack is fully exhausted.
Battery pack	The battery pack is quickly exhausted.	<ul style="list-style-type: none"> .The atmospheric temperature is too low. .The battery pack has not been charged fully. .The battery pack is completely dead, and cannot be recharged, Use another battery pack. . You take too many photos with flash in black.
DV and battery	The DV or battery is hot	<ul style="list-style-type: none"> . Using the DV continually for a long time.
Photos	The photos are too blur	<ul style="list-style-type: none"> . Exposure is not sufficient, you can set larger EV digit. . You may take photos without using flash. . Adjust brightness of the LCD monitor.
Deleting	You can't delete the files	<ul style="list-style-type: none"> . They were locked. You can cancel protection before deleting these files

SD card	You can't format a SD card	. It is locked. You can cancel protection.
SD card	You can't insert an memory card correctly	. The direction of inserting card may be incorrect.
Time Set	Date/Time shown on LCD is incorrect	. The set is wrong. Please re-set Date/Time.
Downloading	Clips/ still image/ mp3 can't be downloaded from DV to PC.	. There may not install the drive of DV in your PC. Please install drive before downloading.
Video file	Can not play video in your computer	. You have not installed the DivX codec for your MPEG4 videos decompression. About your installation please read "Installing Digital Images Manager Software".

Specifications

Image Sensor	2592 x 1944 Mega Pixels CMOS Sensor
Image Resolution	DigitalCamera: 3648*2736(10M),3072*2304(7.0M),2592*1944(5.0M),2048*1536(3.0M),1280*960(1.3M) Video: 640*480 (VGA) / 320*240 pixels (QVGA) PC CAM: 640*480 pixels (VGA), 320*240 pixels (QVGA)
LCD Display	2.0" TFT (270degree eddy)
Internal Memory	Internal DDR (16MB),32M NAND flash memory
External Memory	SD/MMC card for optional SD cards
Lens	f=7.45mm, F3.0
Zoom	4X Digital Zoom
Optical Viewfinder	N/A
Shutter Speed	About 1/6-1/15000S
Exposure	-2.0EV ~ +2.0EV
White Balance	Auto, Daylight, Tungsten, Fluorescent, Cloudy
Self-timer	10s/20s
File Format	Still Image (JPEG) / Video (Mpeg4)/MP3/WAV
Printer	Pictbridge compatible

Storage capability (128MB SD card) Note: any size SD card can be used up to 2 GB, which can be purchased at most consumer Electronic retail stores. Please use a good quality card	128 MB SD card: 1. Photos (JPEG format): Normal quality: about 636pcs (1M); 248pcs (3M); 154pcs (5M); 109pcs (7M); 77pcs (10M) Fine quality: about 423pcs (1M); 165pcs (3M); 102pcs (5M); 72pcs (7M); 51pcs (10M) Super quality: about 338pcs (1M); 131pcs (3M); 82pcs (5M); 58pcs (7M); 41pcs (10M) 2. Video clips (AVI format): about 00:05:05 hours(30fps/VGA); 00:10:11 hours (30fps/QVGA) 3. Audio: about 06:17:08 hours
Flash	YES(IGBT)
Interface	USB 2.0
TV out	YES
Microphone	YES
System Requirements	Win98SE/ME/Win2000/XP/VISTA
Accessories	Software CD, User's manual, AV cable, USB cable, earphone, Gallus, hop-pocket
Battery	3.7V Li-Battery
Working Temperature	0-40 °C

PO701116