

8mm VIDEO CAMCORDER

E

# Instruction Manual

Introduction

Mastering  
the Basics

Using the Full  
Range of Features

Editing

Additional  
Information

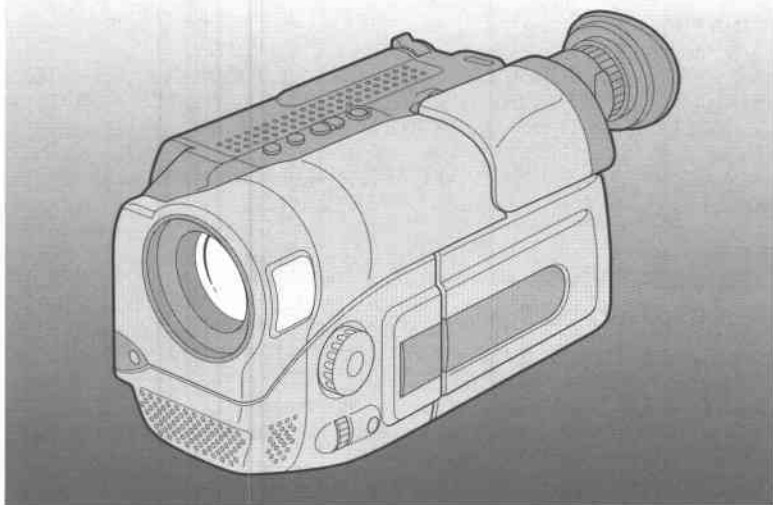

# Canon

**UC-V30Hi Hi8 / UC-V20Hi Hi8**

**UC-V300 8 / UC-V200 8**

**PAL**

This manual explains how to use the UC-V30Hi, UC-V20Hi, UC-V300 and UC-V200 camcorders. In certain areas, some of these four models may not be available.

# Important Usage Instructions

E

Introduction

**CAUTION:**



**TO REDUCE THE RISK OF ELECTRIC SHOCK, DO NOT REMOVE COVER (OR BACK). NO USER SERVICEABLE PARTS INSIDE. REFER SERVICING TO QUALIFIED SERVICE PERSONNEL.**

**WARNING:**



**TO REDUCE THE RISK OF FIRE OR ELECTRIC SHOCK, DO NOT EXPOSE THIS PRODUCT TO RAIN OR MOISTURE.**

**CAUTION:**

**TO REDUCE THE RISK OF ELECTRIC SHOCK AND TO REDUCE ANNOYING INTERFERENCE, USE THE RECOMMENDED ACCESSORIES ONLY.**

**CAUTION:**

**CUSTOMERS IN THE U.K. SHOULD READ THIS BEFORE USING THIS PRODUCT.**

**CHANGING THE FUSE**

THE MAINS LEAD ON THIS PRODUCT IS FITTED WITH A NON-REWIREABLE (MOULDED) PLUG, INCORPORATING A 3 AMP FUSE. SHOULD THE FUSE NEED TO BE REPLACED AN ASTA OR BSI APPROVED BS1362 FUSE OF THE SAME RATING MUST BE USED.

ALWAYS REFIT THE FUSE COVER AFTER REPLACING THE FUSE. NEVER USE THE PLUG WITH THE FUSE COVER OMITTED.

**CHANGING THE PLUG**

IF THE FITTED PLUG IS NOT SUITABLE FOR YOUR SOCKET OUTLETS, IT SHOULD BE CUT OFF AND AN APPROPRIATE PLUG FITTED IN ITS PLACE. IF POSSIBLE FIT AN APPROPRIATE 3 AMP FUSE. IF THE NEW PLUG HAS NO FUSE, THEN FIT A 5 AMP FUSE AT THE DISTRIBUTION BOARD.

**AC POWER CORD CONNECTION (CA-550B only)**

The wires in the mains lead of this apparatus are coloured in accordance with the following cord.

**(IMPORTANT)**



As the colours of the wires in the mains lead may not correspond with the coloured markings identifying the terminals in your plug, proceed as follows: The wire which is coloured BLUE must be connected to the terminal which is marked with the letter N or coloured black. The wire which is coloured BROWN must be connected to the terminal which is marked with the letter L or coloured red. Neither Blue wire or Brown wire is to be connected to the Earth pin of a 3 pin plug.

**THE SEVERED PLUG MUST BE DESTROYED IMMEDIATELY TO AVOID ANY POSSIBLE ELECTRIC SHOCK HAZARD.**

# Contents

## Introduction

Important Usage Instructions .....	2
Thank You for Choosing a Canon .....	4
Introducing the Camcorder .....	5

## Mastering the Basics

Powering Your Camcorder .....	6
– Connecting the camera to a mains outlet .....	6
– Attaching and charging a battery pack .....	7
Loading a Cassette .....	9
Basic Recording .....	11
Zooming .....	13
Using the LCD Screen .....	15
Playing Back a Cassette .....	18
Connections for Playback on a TV Screen .....	22
Tips for Making Better Videos .....	27

## Using the Full Range of Features

### ~ General ... ~

Turning the Image Stabilizer On/Off (UC-V30Hi/UC-V20Hi/UC-V300) .....	29
Using the Wireless Controller .....	30

### ~ For Recording ...~

Setting the Date and Time .....	31
Titles .....	33
Searching and Reviewing While Recording .....	36
Using the Various Recording Programs .....	38
Using the Digital Effects .....	40
Using the Digital Faders .....	42
Audio Recording .....	44

~ When Making Manual Adjustments ...~ Focusing .....	45
Exposure .....	47

### ~ For Playback ...~

Searching the Tape (Date Search) .....	49
Using the PAL 60 System .....	50

## Editing

The Auto Editing Function .....	51
Preparing for Editing .....	52
Using the Editing Function for the First Time .....	53
Choosing a Scene .....	55
Preview and Recording .....	56
Cut-In and Cut-Out Adjustments .....	57
Deleting Scenes and Clearing the Program .....	59
Reordering Scenes .....	60
Editing Scenes .....	61
Simple Editing to a VCR .....	62

## Additional Information

Preparing the Camera .....	63
Notes on Using the Batteries .....	65
Maintenance .....	69
Troubleshooting .....	73
The Video System Diagram .....	77
Optional Accessories .....	78
Finding Your Way Around the Camcorder .....	81
Screen Displays .....	84
Specifications .....	87
Index .....	88

# Thank You for Choosing a Canon

First, we'd like to thank you for purchasing this Canon camcorder. Its advanced technology makes it very easy to use — you will soon be making high-quality videos which will give you pleasure for years to come.

To get the most out of your new camcorder, we recommend that you read this manual thoroughly — there are many sophisticated features which will add to your recording enjoyment.

## Getting started







To get started we suggest that you master the basic operations of the camcorder first, before moving on to use its full range of features.

For quick reference (in addition to the contents and index) please refer to:

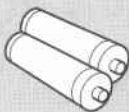
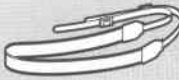
- Finding Your Way Around the Camcorder (p. 81)
- Screen displays (p. 84)
- Troubleshooting — in case you run into any problems (p. 73)

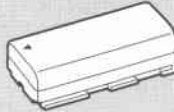
Note that capital letters are used to refer to settings that appear in the display and buttons labelled on the camcorder itself e.g. Press the EJECT  button.

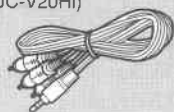
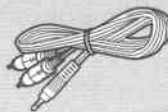
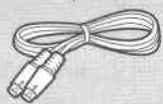
Your camcorder is supplied with the following accessories:

WL-83 Wireless Controller 	Two AA batteries 
SS-81 Shoulder Strap 	Lens cap and lens cap cord 
BP-915 Battery Pack 	CA-550 Compact Power Adapter 
Lithium backup battery (CR2025) 	STV-250 Stereo Video Cable (for UC-V30Hi/UC-V20Hi) 
C-250 AV Cable (for UC-V300/UC-V200) 	S-150 S-video Cable (for UC-V30Hi/UC-V20Hi) 
PC-A10 SCART Adapter (Europe, Asia) 	

# Introducing the Camcorder

## LCD Screen



An LCD screen makes it easy for you to shoot colourful, well composed video. You can even put yourself in the frame and check the picture as you shoot. It is also great for playback.

## Auto Editing Function



A complete set of editing functions is built-in — turn your recordings into finished productions, with no extra equipment required.

## FlexiZone Control



Easier than manual operation and more flexible than automatic functions, Canon's FlexiZone Control is a completely new way to use a video camera.

## Image Stabilizer (UC-V30Hi/UC-V20Hi/UC-V300)



Images are stabilized even in long telephoto shots.

## 22× lens and 100×/290× digital zoom



From wide-angle to 22× telephoto — with unparalleled optical quality. The digital zoom magnifies this up to 100× for even more dramatic results. Also, the picture magnifies up to 290× with Digital Effects.

## Close-Up



The subject can be further digitally enlarged by 1.5×, for a maximum of 440× magnification.

## Hi8 (UC-V30Hi/UC-V20Hi)



Hi8 is the format that most video professionals rely on for high quality and long recording times.

## Digital Effects and Faders



Advanced digital technology allows you to add special effects and scene transitions to your recordings.

## Titles



You don't need any extra equipment to add titles to your home videos — the camera does it all.

## Hi-fi stereo sound (UC-V30Hi/UC-V20Hi)



The compact integral microphone offers the depth and realism of AFM in full dynamic stereo.

## Long Time Recording



You can record up to 11 hours (12 hours for UC-V200) continuously with two BP-941 Battery Packs (optional) on the CH-900 Dual Battery Charger/Holder (optional).

## Powering Your Camcorder

Before operating your camera, you will need to use the power adapter to:

**provide power from a mains outlet or charge a battery pack**

### Notes:

- The power adapter converts current from a household power outlet (110–240 V AC, 50/60 Hz) to the DC current used by your camera.
- If the adapter is used next to a TV, it may cause the TV to emit noise — move the adapter away from the TV or the aerial cable.

### Connecting the camera to a mains outlet

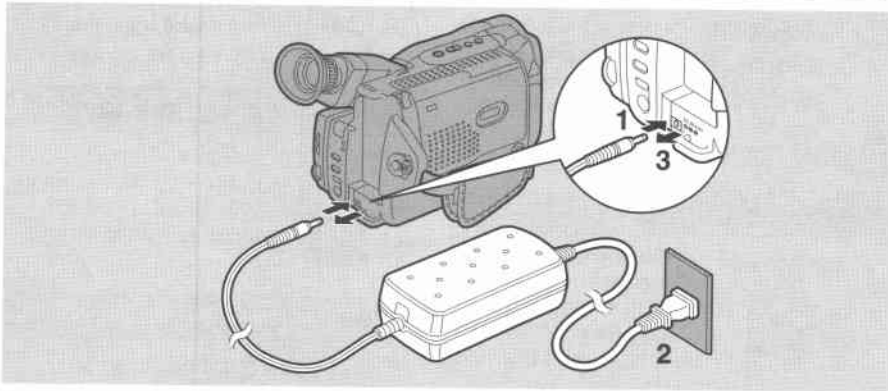

Use the power adapter to provide your camera with instant power from a mains outlet.

- 1. Connect the power adapter to the camera.**
- 2. Plug the adapter into a mains outlet.**
- 3. Remove the power adapter after use.**
  - Always turn the camera off before removing the power source.

### CA-550 Compact Power Adapter

#### Specifications

Power supply	110 – 240 V AC, 50/60 Hz
Power consumption	20 W
Rated output	8.4 V, 1.5 A DC
Operating temperature range	0° – 40°C (32 – 104°F)
Dimensions	64 × 130 × 43.5 mm (2 1/2 × 5 1/8 × 1 3/4 in)
Weight	305 g (10 3/4 oz) UK model: 370 g (13 oz) Australia model: 310 g (10 7/8 oz)

Weight and dimensions are approximate. Errors and omissions excepted. Subject to change without notice.

CA-550 identification plate is located on the bottom.

## Attaching and charging a battery pack

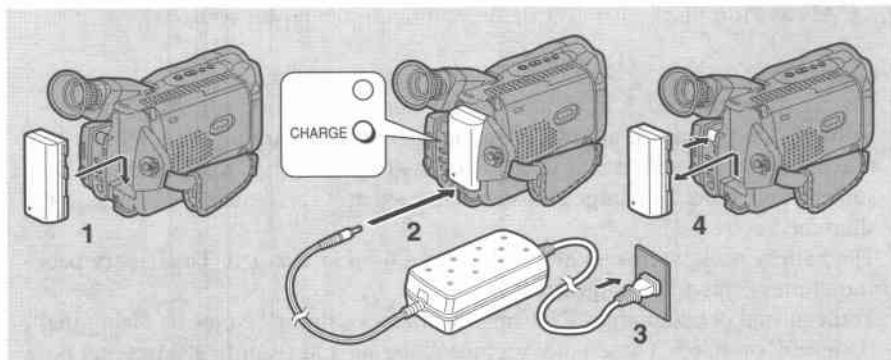

Your battery pack was partially charged before it left the factory. It should have enough power for you to check that your camera is working properly. However, you must charge the battery pack fully if you want it to power the camera for more than a few minutes.

It is recommended to set the POWER switch to OFF when charging a battery pack. However, if the POWER switch is set to CAMERA and the camcorder stays in record pause mode for over five minutes, it will automatically turn itself off and start charging the battery pack.

If a fully charged battery pack is removed and then re-attached, it will need another few minutes of charging to reach fully charged status again.

Use only the CA-550 Compact Power Adapter to charge battery packs.

### 1. Attach the battery pack to the camera.

- Align the triangle on the battery pack with the guide line on the camera.
- Slide it in the direction of the arrow until it clicks into place.
- Be sure to test the battery pack to check that it is properly attached.

### 2. Connect the power adapter to the camera.

### 3. Plug the power adapter into a mains outlet.

- The CHARGE indicator flashes to show that charging is in progress. Single flashes mean that the battery pack is less than 50% charged. Double flashes mean that it is between 50% and 75% charged. Triple flashes mean that it is more than 75% charged.
- The indicator glows steadily when the battery pack is fully charged. Battery pack usage time will be further extended if you continue charging for an hour after the indicator starts glowing steadily.
- If the indicator flashes once every two seconds, the battery pack could be defective.
- The indicator will not light at all when the power adapter is defective.

#### 4. Remove the battery pack after use.

- Press and hold the BATTERY RELEASE button.
- Always turn the camera off before removing the power source.

#### Notes:

- Charge the battery pack in an ambient temperature of 10°C to 30°C. If the battery pack is charged at low or high temperatures, charging takes longer. If the ambient temperature is 0°C or lower or 40°C or higher, the battery pack sometimes cannot be charged. Also, the time that it can be used is drastically shortened.
- The battery pack warms up after it has been used or charged. The battery pack sometimes cannot be charged if it is warm.
- You can find detailed notes for using the batteries in the “Notes on Using the Batteries” on p. 65. These notes include charging and recording times and how to install the backup battery.



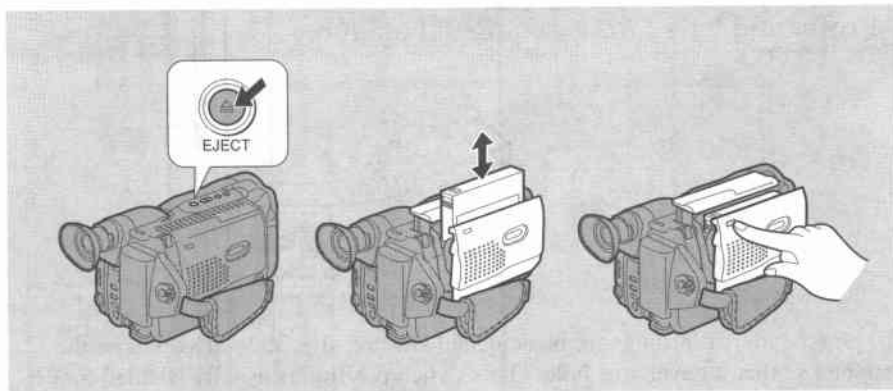

## Loading a Cassette



Only use videocassettes marked with an **8** (or **Hi8** for UC-V30Hi/UC-V20Hi).

### Loading and unloading

1. Make sure that you have attached or connected a power source.
2. Press the EJECT  button and wait for the cassette compartment to open.
3. Load or unload the cassette.
  - Insert the cassette gently with the window facing out and the erasure prevention tab to the top left.
  - Remove the cassette by pulling it straight out.
4. Press the  mark on the compartment until it clicks, and wait for it to close.
  - Press the  mark horizontally.

#### Notes:

- See p. 10 for information on protecting your recordings from accidental erasure.
- If you turn the camera on with no cassette loaded, “” flashes in the display.
- After loading a cassette, use record search (p. 36) to find the point where you want to start recording.
- Do not interfere with the cassette compartment while it is opening or closing automatically.
- Do not leave the cassette in the camera after use — return it to its case and store it in a cool, clean, dry place.

## Protecting tapes from accidental erasure

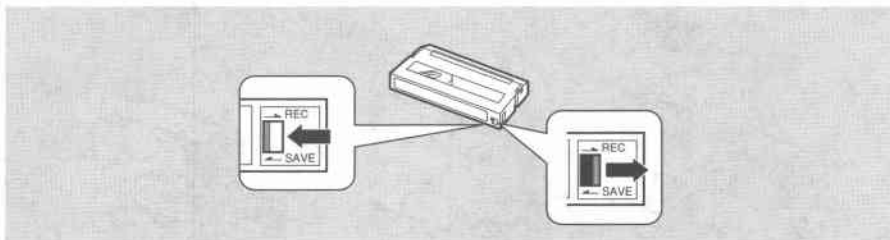

To protect your recordings from accidental erasure, slide the red switch on the cassette so that it covers the hole. (This switch position is usually labelled SAVE or ERASE OFF.) If you load this cassette and power on the camera, “” flashes in the display.

If you want to record on the cassette again, slide the red switch back so the hole is open. (This position is usually labeled REC or ERASE ON.)

## Handling cassettes

- To protect the tape heads, transfer cassettes directly from the tape case to the camcorder – do not open the tape protect cover or touch the tape itself.
- Do not use cassettes where the tape has been damaged or rejoined – they may damage the camcorder.
- Do not insert anything into the small holes on the cassette or cover them with cellophane tape.
- Handle cassettes with care – dropping them or exposing them to external shocks may cause internal damage.
- Store cassettes in the provided case, rewinding them to the start of the tape first, and then storing them upright.

## About Hi8 (for UC-V30Hi/UC-V20Hi)

To record or play back in the Hi8 format, you need both a Hi8 camcorder and a Hi8 cassette (you can use either Metal-P or Metal-E Hi8 cassettes).

A Hi8 camcorder can record or play back in either the Hi8 format or standard 8mm format, depending on the tape used.

The superior quality of Hi8 can best be appreciated on a TV which has an S-video input terminal.

## Basic Recording

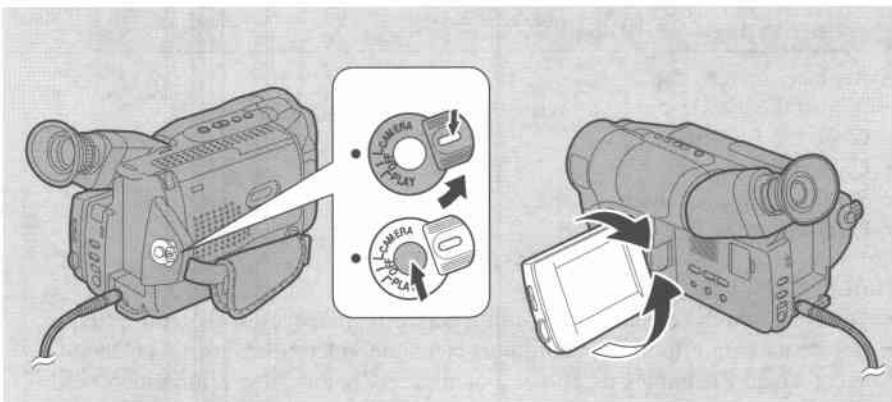

### Before you start recording

Have you completed the following steps?

- Attached a power source (p. 6).
- Loaded a cassette (p. 9).
- Adjusted the LCD screen (p. 15) or viewfinder, fastened the grip belt and taken off the lens cap (p. 63).

You may also want to install the backup battery (p. 67) in order to set the date and time display (p. 31).

### To record

- 1. Press down and turn the POWER switch to CAMERA.**
  - PAUSE appears in the display — the camera is now in “record pause mode.”
- 2. Press the red start/stop button to begin recording.**
  - The tally lamp flashes and REC appears in the display.
- 3. Press the start/stop button again to pause recording.**
  - The camera returns to record pause mode and PAUSE reappears in the display.
  - You can stop and restart recording as often as you like by pressing the start/stop button.
  - The camera will turn itself off if you leave it in record pause mode for more than about five minutes. To return to record pause mode, repush the start/stop button, or set the power switch to OFF and then back to CAMERA.

## When you have finished recording

- Replace the lens cap.
- Return the viewfinder to its retracted and lowered position.
- Close the LCD panel.
- Unload the cassette.
- Set the POWER switch to OFF.
- Disconnect the power source.

### Notes:

- To check that the camera is recording correctly, make a test recording first.
- Before making important recordings, clean the video heads using a Canon CC-8 Video Head Cleaning Cassette or a commercially available 8mm video head cleaning cassette.
- You cannot monitor the sound from the speaker when recording.
- For tips on how to make better videos, see page 27.

## Recording with the LCD screen

In place of using the viewfinder, you can also monitor recording using the LCD screen.

When you open the LCD panel, the viewfinder turns off automatically.

For more details please refer to "Using the LCD Screen" (p. 15).

### Notes:

- You cannot monitor the sound from the speaker during recording.
- The LCD screen uses a lot of power, so possible recording time will be less than if you were to use the viewfinder.
- Be sure to close the LCD panel flush to the camera body when you have finished recording with the LCD screen.

## Zooming

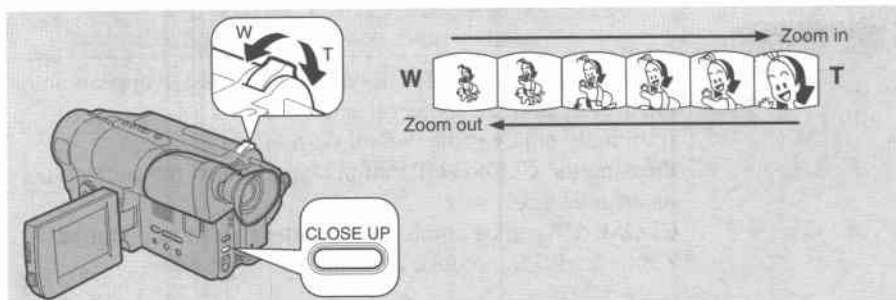

### 22× optical zoom

The camera's 22× zoom lens allows you to choose the best picture angle for each scene:

- Turn the zoom control towards W to zoom out to wide-angle.
- Turn it towards T to zoom in to telephoto.

You can also control the speed of zooming:

- Move the control slightly to zoom slowly.
- Turn it farther to zoom more quickly. (The farther you turn the zoom control, the faster the zoom speed.)

The T and W buttons on the wireless controller adjust the picture angle, but not the zoom speed.

When you operate the zoom control, the zoom bar indicating the zooming position appears in the display, and after about five seconds, the display disappears.

### 100× digital zoom

Turn the zoom control towards T until D.ZOOM appears in the display, to magnify the camera's zoom range by 4.5×.



The zoom control continues to work as usual. You can freely zoom in and out between 1× and 100× magnification — the camera automatically switches between optical zooming (up to 22×) and digital zooming (22× to 100×).

D.ZOOM disappears from the display when you return to optical zooming.

## Close-up



CLOSE-UP

If you press the CLOSE-UP button, CLOSE-UP appears in the display and the subject is enlarged by 1.5 $\times$ .

It digitally enlarges the central portion of the image.

Pressing the CLOSE-UP button again returns the subject to its original size.

CLOSE-UP can be combined with the Extra Long Digital Zoom (p. 40) to produce a magnification of 440 $\times$ .

### Notes:

- When you want to get as close as possible to your subject, keep the zoom at the wide-angle position. You can focus on a subject as close as 1 cm (3/8 in).
- Image resolution is lower when the magnification is greater than 22 $\times$ .
- Optical Zooming and Digital Zooming can also be operated from the wireless controller. However, CLOSE-UP and Extra Long Digital Zoom (p. 40) must first be selected from the camcorder body.

## Using the LCD Screen

### Open the LCD screen

Push the OPEN button and open the panel by pulling it away from the camera. This automatically switches the LCD screen on and the viewfinder off. When you close the LCD panel, the LCD screen automatically switches off and the viewfinder switches back on.

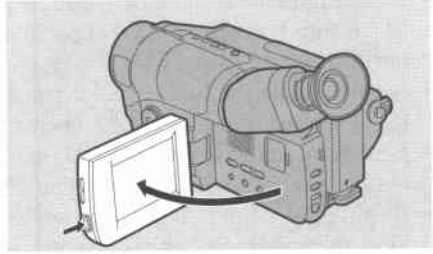

### Changing the angle of the LCD screen

First open out the LCD panel at a right angle (90°) to the camera.

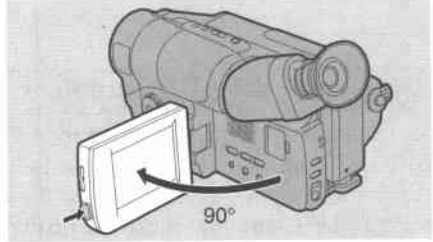

You can now choose the angle of the panel that suits you best by rotating it about this axis.

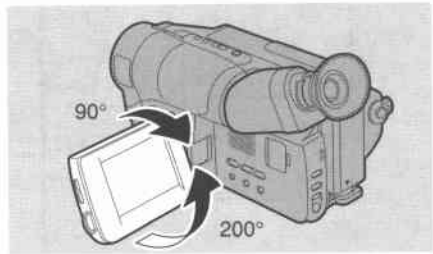

If you rotate the panel around to 180° so that it faces the direction of the lens you can include yourself in the picture, while monitoring the shot on the LCD screen (p.17). The viewfinder is also activated when the panel is in this position.

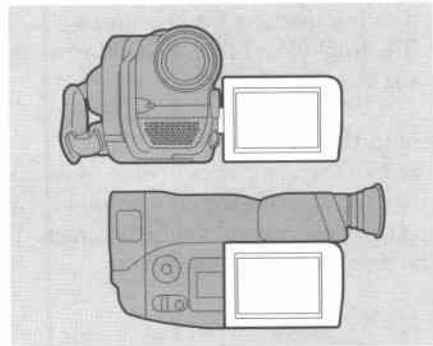

From this position you may also push the panel flat against the camera until it is flush with the side, with the screen facing outwards.

**Notes:**

- Avoid touching the LCD screen when moving the LCD panel.
- Do not hold the camera by the LCD panel or the viewfinder.
- Make sure you open the LCD panel at 90°, before attempting to rotate it backwards or forwards.
- Always rotate the LCD panel vertically into place, before closing it or pushing it flat against the side of the camera.
- Be careful not to leave the LCD, viewfinder or lens exposed to direct sunlight outdoors or in a window. Doing so could cause damage.
- Bright light falling on the LCD screen may cause glare that makes it difficult to view the image. In this case, switch to using the viewfinder. You are also able to adjust the brightness of the screen (see “Adjusting the LCD screen” below). The camera automatically brightens the backlight of the screen when recording outdoors.

### Adjusting the LCD screen

You can adjust the brightness of the LCD screen. Adjust the level using the BRIGHT buttons on the end of the LCD panel.

A bar showing the level appears in the display.

- Press the + button to make the display brighter.
- Press the – button to make the display darker.

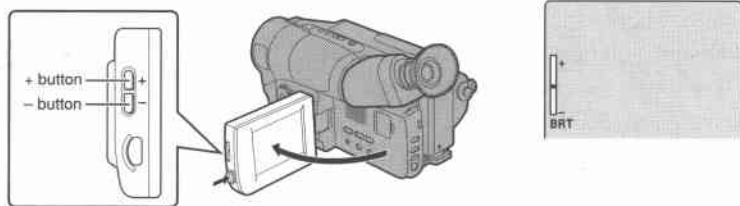
**Notes:**

- The bar showing the brightness disappears from the display in a few seconds.
- The brightness of the LCD screen does not affect that of the recorded images or the viewfinder.

**About the LCD Screen**

The LCD screen built into this camcorder is a high precision product.

However, small black dots or bright points of light (red, blue or green) may appear constantly on the LCD screen. This is not a malfunction of the LCD screen and they are not recorded on the tape. (Effective dots: more than 99.99%)



## Allowing the subject to monitor recording

E

When you turn the LCD panel so that it faces the opposite direction (see diagram below), you can watch yourself during recording or let your subject monitor recording.

1. **Open the LCD panel (p. 15).**
2. **Rotate the LCD panel 180° until the screen faces the same direction as the lens.**
  - Adjust the angle so that you can view it easily.
  - The viewfinder is also activated when the LCD is in this position.
3. **Use the wireless controller to start and stop recording (p. 30).**

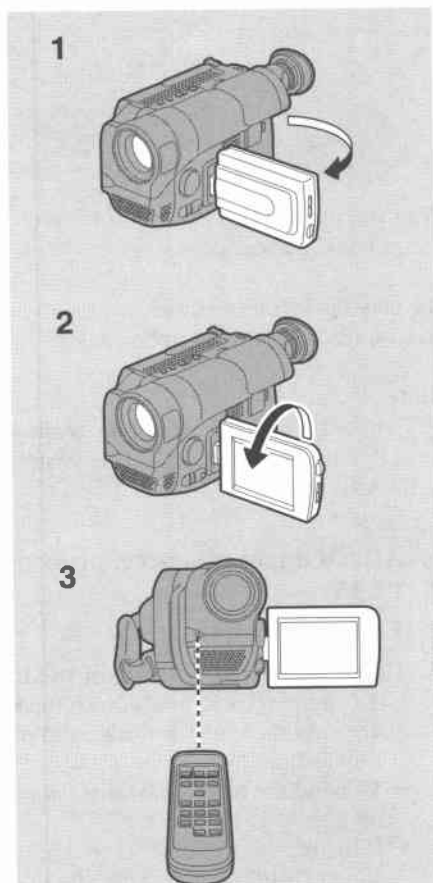

### Notes:

- When you flip over the LCD panel, the display automatically changes to a mirror-image.
- Screen displays are reversed, but titles/dates are correctly recorded without affecting the recording.
- It is also possible to monitor the shot through the viewfinder while the subject monitors the shot in the LCD screen.

## Playing Back a Cassette

E

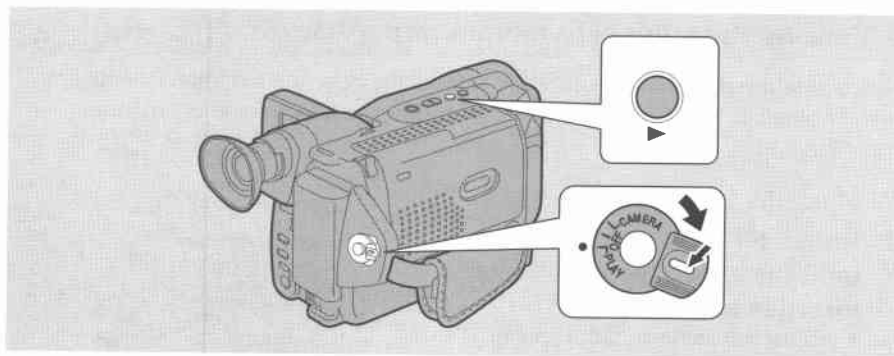

You can use the LCD screen for instant, on-the-spot playback. The camera also plays back the soundtrack via the built-in speaker (p. 20).

To play back your recordings on a TV, see p. 22.

To use the wireless controller, see p. 30.

### Note:

- To avoid accidental recording, make sure that you slide the tab on the cassette so that it exposes the hole (the switch position is usually labelled SAVE or ERASE OFF).

1. **Attach a power source, press down and turn the POWER switch to PLAY.**
2. **Load the cassette.**
3. **Press the ► (play) button to start playback.**
  - To end playback, press down the ■ (stop) button.
  - To wind the tape forwards, stop playback and press down the ►► (fast forward) button.
  - To wind the tape backwards, stop playback and press down the ◀◀ (rewind) button.
  - If the playback picture is rough, clean the video heads using a Canon CC-8 Video Head Cleaning Cassette or a commercially available 8mm video head cleaning cassette.

## Special playback

### Still playback

To view the video as a still picture, press the start/stop button on the body of the camera during normal playback (or press the **||** (pause) button on the wireless controller). Press the same button again to resume normal playback. The camera automatically goes into stop mode after about five minutes' still playback.

### Fast forward playback

To play back the recording at 9 times the normal speed (6 times normal speed when the LCD panel is opened), press and hold the **▶▶** (fast forward) button during normal playback.

### Rewind playback

To play back in reverse at 7 times the normal speed (4 times normal speed when the LCD panel is opened), press and hold the **◀◀** (rewind) button during normal playback.

### High-speed search

To play back the recording at about 9 times normal speed, press and hold the **▶▶** (fast forward) button during normal fast forward. For reverse playback at about 7 times normal speed, press and hold the **◀◀** (rewind) button during normal rewind.

#### Notes:

- The LCD screen is free from noise bars during still playback, fast forward playback and rewind playback (Clear Search).  
Some flicker or distortion may appear on the screen of the viewfinder or a connected television.  
With the LCD closed during special playback, some flicker or distortion may appear on the screen if the LCD is then opened.  
The soundtrack cannot be heard during special playback.
- During still playback, fast action scenes may appear blurred.
- You can use the wireless controller's ON SCREEN button to turn the on-screen displays on/off (p. 84).

## Built-in speaker

The camera has a built-in speaker so you can review the soundtrack alongside the picture during playback.

Adjust the speaker volume by pressing the FlexiZone controller.

- A bar appears in the display temporarily to indicate the current volume.
- Press upwards to increase the volume. Press downwards to decrease the volume.
- You can also use the ▲/▼ keys on the wireless controller to adjust speaker volume.

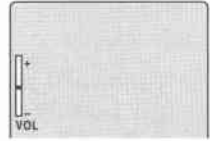

**Note:**

- When the LCD panel is closed, the speaker does not work.

## Tape return

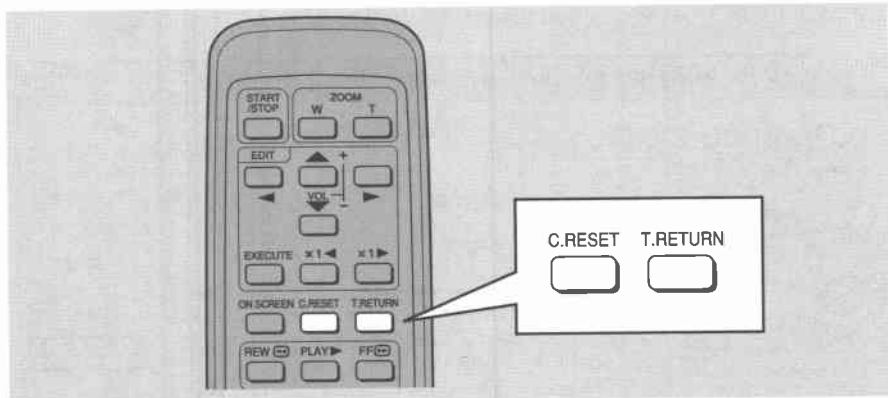
**E**

Use the wireless controller's T. RETURN button to quickly return to a scene you want to see again. You can operate this function from the wireless controller only.

**1. Press the C.(counter) RESET button during playback if you come across a scene you want to watch again later.**

- The tape counter is reset to 0:00:00.

**2. When you have ended playback, press the T. RETURN button.**

- The tape is wound forwards or backwards until the counter reaches 0:00:00.
- T.RTN ►► and a “-” mark in front of the counter, or T.RTN ◀◀ only appears in the display.
- You can cancel tape return by pressing the ■ (stop) button.

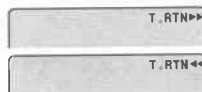

**3. Start playback.**

**Notes:**

- The tape counter is reset when a cassette is unloaded.
- You cannot use the tape return if the tape counter is already near 0:00:00.

## Connections for Playback on a TV Screen

E

You can connect the camera to a TV or VCR in order to play back your recordings. You will need to attach a power source to the camera (see p. 6). See your TV or VCR instruction manual for further details.

### If your TV (or VCR) has a SCART terminal (without S-video)

#### UC-V30Hi/UC-V20Hi

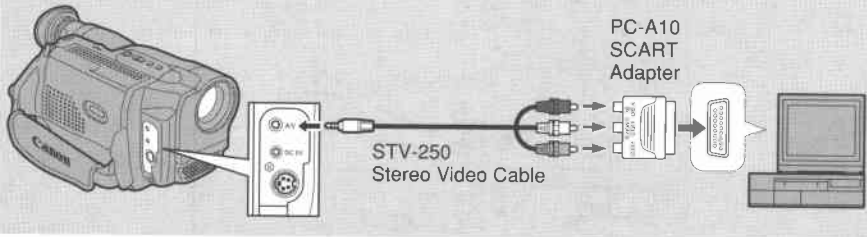

- Connect the PC-A10 SCART adapter to the TV or VCR's SCART terminal.
- Connect the camera to the adapter. Connect the camera using the STV-250 Stereo Video Cable. Connect the white plug to the white audio terminal L (left). Connect the red plug to the red audio terminal R (right). Connect the yellow plug to the yellow video terminal VIDEO.
- Set the TV/VIDEO selector on the television to VIDEO.
- If you are connecting the camera to a VCR, set the input selector on the VCR to LINE.

#### UC-V300/UC-V200

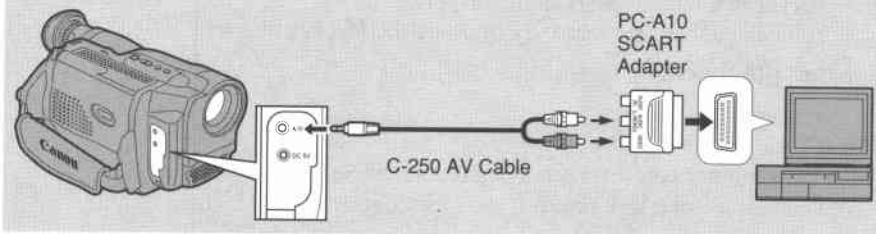

- Connect the PC-A10 SCART adapter to the TV or VCR's SCART terminal.
- Connect the camera to the adapter. Connect the camera using the C-250 AV Cable. Connect the white plug to the white audio terminal L (left). Connect the yellow plug to the yellow video terminal VIDEO.
- Set the TV/VIDEO selector on the television to VIDEO.
- If you are connecting the camera to a VCR, set the input selector on the VCR to LINE.

**If your TV (or VCR) has an S-video input terminal  
(for UC-V30Hi/UC-V20Hi)**

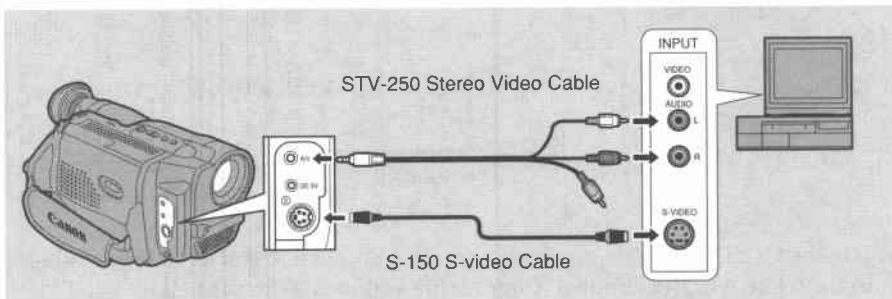

- Use the S-150 S-video Cable to connect the S-video terminal (S). Use the STV-250 Stereo Video Cable to connect the A/V terminal. Connect the white plug to the white AUDIO terminal L (left). Connect the red plug to the red AUDIO terminal R (right). Do not connect the yellow plug.
- Set the TV/VIDEO selector on the television to VIDEO.
- If you are connecting the camera to a VCR, set the input selector on the VCR to LINE.

**If your TV (or VCR) has audio/video input terminals**

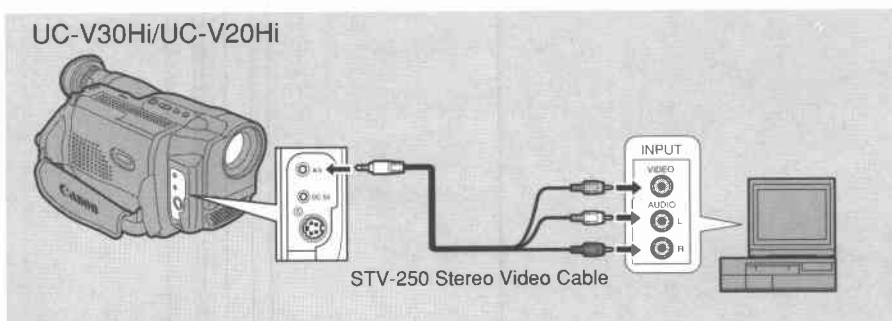

- Use the STV-250 Stereo Video Cable to connect the A/V terminal. Connect the white plug to the white audio terminal L (left). Connect the red plug to the red audio terminal R (right). Connect the yellow plug to the yellow video terminal VIDEO.
- Set the TV/VIDEO selector on the television to VIDEO.
- If you are connecting the camera to a VCR, set the input selector on the VCR to LINE.

UC-V300/UC-V200

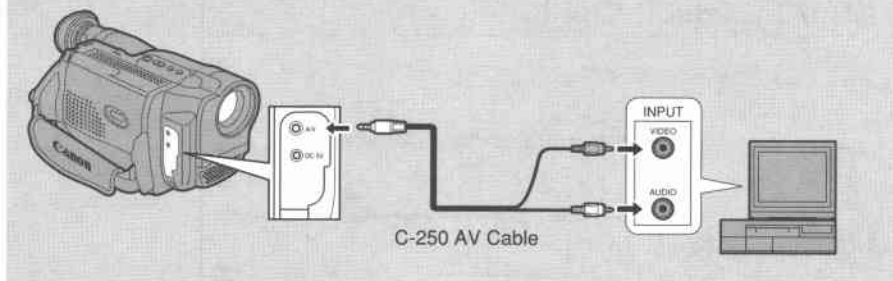

- Use the C-250 AV Cable, to connect the A/V terminal. Connect the white plug to the white AUDIO terminal. Connect the yellow plug to the yellow VIDEO terminal.
- Set the TV/VIDEO selector on the television to VIDEO.
- If you are connecting the camera to a VCR, set the input selector on the VCR to LINE.

**Note:**

- If you are going to use the TV as a monitor while you are shooting, remember to keep the TV volume turned down as long as the camera's audio terminals are connected. If the sound from the TV speakers is picked up by the microphone, an unpleasant high-pitched squeal, called feedback, may be produced.



## If your TV does not have audio/video terminals

**E**

### European model

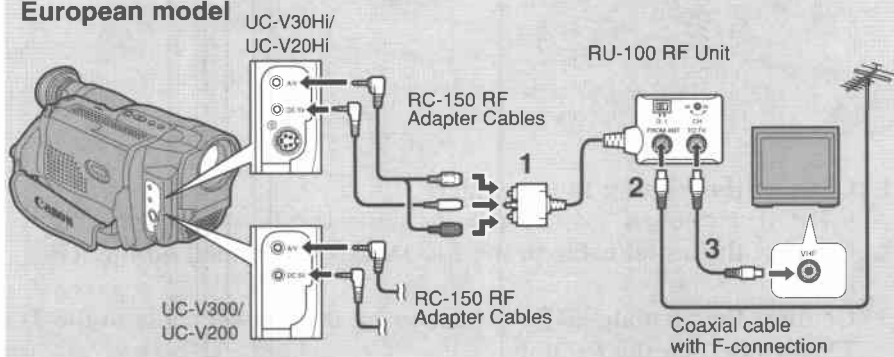

### Australian model

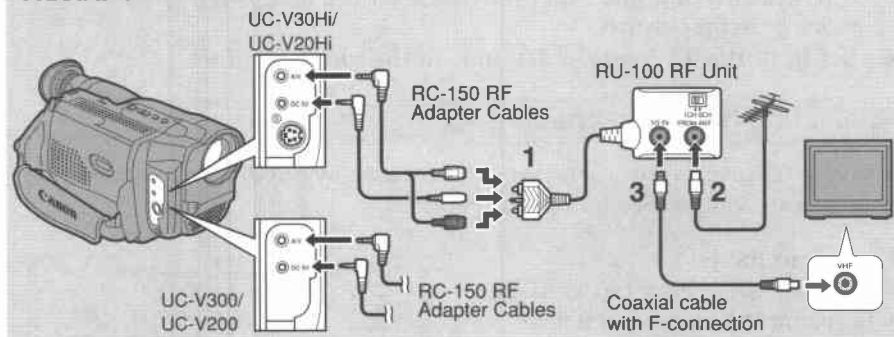

If your TV is already hooked up to a VCR, you can connect the camera to the VCR instead of the TV. Follow the instructions above.

To connect the camera directly to a TV which does not have audio/video terminals, you will need to use the optional RU-100 RF Unit together with the optional RC-150 RF cables. The soundtrack will be in mono.

## Connecting the RF unit



Coaxial cable  
with DIN-connectors

Male Female

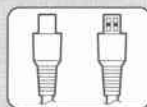

1. Connect the RF unit to the camera.
  - The RF unit and RF adapter cables are available optionally.
2. Connect the aerial cable to the FROM ANT. terminal on the RF unit.
3. Connect the “female” DIN-connector on the coaxial cable to the TO TV terminal on the RF unit.
4. Connect the “male” connector to the aerial input on the TV.
5. Turn the TV on, and start playback on the camera.
  - See p. 18 for playback.
6. Set both the TV and the RF unit to the video channel.

## Selecting the video channel

The video channel is the channel which is not used by broadcasting stations in your area and can be used for cassette playback.

### European model

First set the G/I selector on the RF unit.

- In continental Europe, set it to G.
- In the UK, Hong Kong and South Africa, set it to I.

If it is not set properly, you will be able to see the picture, but not hear the sound.

Next, set the TV and the CH selector on the RF unit to the video channel. The selector is factory-set to channel 32. Adjust it by turning until the picture is clear.

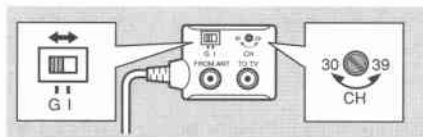

### Australian model

Set the TV and the RF unit to channel 0 or 1.

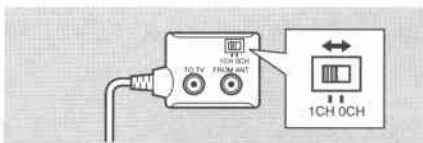

### Note:

- Turn the camera off or disconnect it from the RF unit when you want to watch a broadcast programme. If you leave the camera connected and turned on, the RF unit will automatically select the camera signal instead of the broadcast signal.

## Tips for Making Better Videos

### Holding the camera

For maximum stability, place your right hand through the grip belt and keep your right elbow pressed against your body. Support the camera underneath with your left hand. With practice, you will be able to operate the controls by touch, without taking your eye off the action.



### Using a tripod

To prevent any unwanted movement, you can mount the camera on a tripod, (or any flat surface at a suitable height) and operate it with the wireless controller.

- When you are using a tripod, be careful not to leave the viewfinder exposed to bright sunlight or it may melt. (The light is concentrated by the viewfinder lens.) Avoid damage by returning the eyepiece to its retracted position.
- Make sure that the fastening screw of the tripod is no longer than 6 mm ( $\frac{1}{4}$  inch), or it will damage the camera.

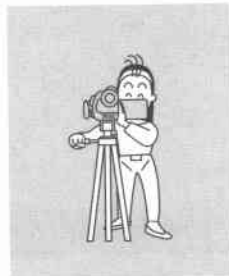

### Composition

The most important element in the scene does not have to be in the centre. For a more interesting picture, try to position your subject so it is slightly to one side. Leave some space on the side of the frame that the subject is facing or moving towards.

Don't cut off the top of the subject's head, and don't cut people off at the neck, hips or knees (move a little bit above or below).

Watch out for distracting objects in the background.



## Picture angle

Instead of zooming while recording, try to choose your picture angle before you begin. A good way to tell a story with video is to begin with a long shot that establishes the situation, and then move in with medium shots and close-ups to show the details. Remember to change your viewpoint for each shot.



Long shot



Medium shot



Close-up

Remember that any camera movement or change in picture angle should have a definite purpose. Avoid unnecessary or half-hearted movements.

## Camera moves

Use pans to record a landscape or follow a moving subject. Decide the area you want to cover and stand facing the end of your panning angle. Without moving your feet, turn your waist to the starting position. Start recording, and after a few seconds begin to turn slowly from the waist. Hold the final image for a few seconds before you stop recording.

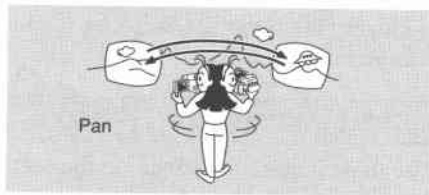

Pan

Tilt the camera up to exaggerate the height of the subject. Tilt down from the top of a building, for example, as an introduction to subjects at the bottom.



Tilt

## Turning the Image Stabilizer On/Off (for UC-V30Hi/UC-V20Hi/UC-V300)

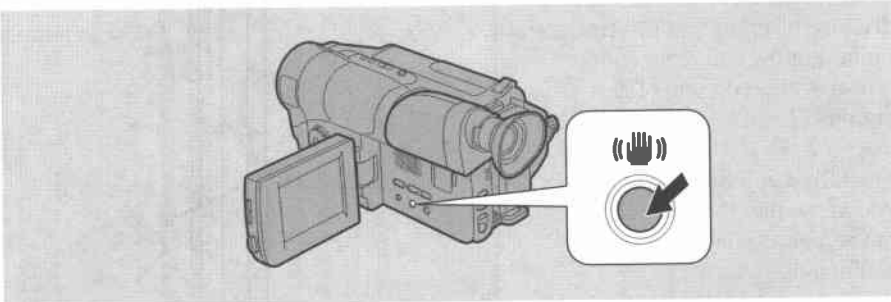

With most camcorders, even the slightest hand movements will be noticeable during telephoto recording. However, the camera's image stabilizer allows you to obtain steady recordings even at high magnification.

Before you start recording, open the LCD panel and push the  button to turn the image stabilizer on or off.



- The  mark appears in the display when the stabilizer is on.

### Notes:

- Each time you turn the camera on, the image stabilizer is automatically reset to on.
- The image stabilizer is designed to deal with a normal degree of camera shake.
- Keep the image stabilizer turned off when the camera is mounted on a tripod.
- The image stabilizer is not as effective as usual when the optional tele-converter is attached.

## Using the Wireless Controller

E

The supplied wireless controller can operate the camera from a distance of up to 5 m (16 feet). Point it at the camera's remote sensor while you press the buttons.

The tally lamp lights up to let you know that the camera is in range and responding to your commands.

There are three functions which can only be operated using the wireless controller:

- Tape return (p.21)
- ON-SCREEN displays (p. 84)
- Forward  $\times 1 \blacktriangleright$  / Reverse  $\times 1 \blacktriangleleft$  modes (p. 55)

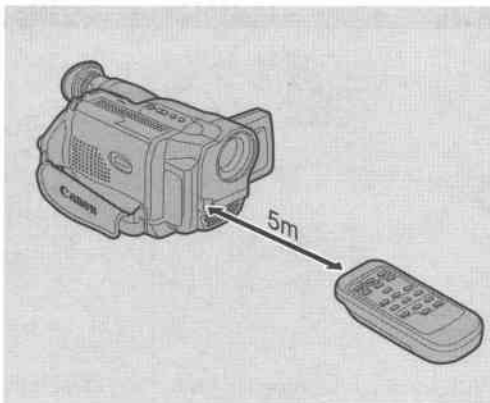

### Inserting batteries

Insert two AA batteries, following the  $\oplus$  and  $\ominus$  markings. Be careful not to reverse the polarity of the batteries.

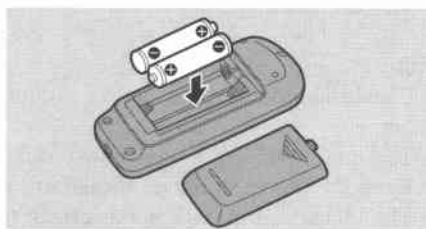

#### Notes:

- When using the wireless controller in brightly lit places or outdoors, the effective range will be less.
- The camera may have difficulty picking up the remote control signals at extremely close range.
- Do not leave the controller exposed to direct sunlight, or in hot or humid places.
- When the batteries run out, replace them both together.

## Setting the Date and Time

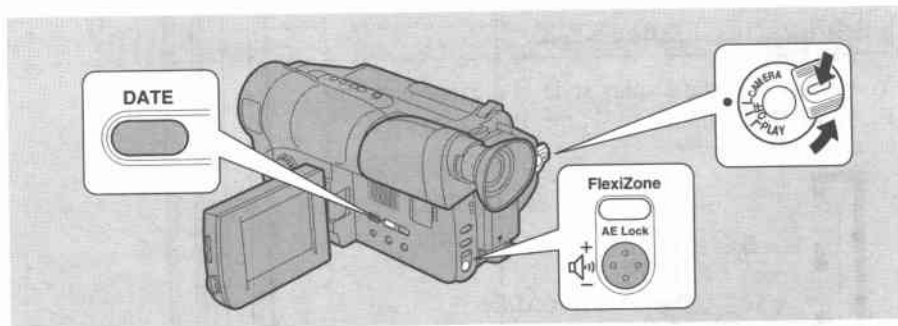

The date and/or time display appears in the display when you press the DATE button. If you start recording now, it will be superimposed on the scene.

Set the date and time display when you first start using your camera. As long as you have installed the backup battery (p. 67), the camera's internal clock will continue to work even when the main power source is removed.

1. Put the camera in record pause mode.
2. Press and hold the DATE button for about three seconds.
  - The day display starts to flash.

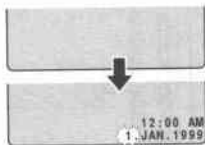

3. Press the FlexiZone controller up or down to change the day. Press the FlexiZone controller right or left to move to another part of the display.
  - Press and hold up or down to scan the days quickly.
  - Once you move from the day, the next part of the display starts flashing.
4. Set the month, year, hours and minutes in the same way.
5. Press the DATE button when finished.
  - The internal clock starts.

### Notes:

- The date can be set to any year between 1999 and 2099.
- To change part of the date and time, press and hold the DATE button for three seconds, then use the FlexiZone controller to go straight to the place you want to change.

**E****Setting the display style**

You can choose the display style of the date and time.  
Press the DATE button to set the display style.

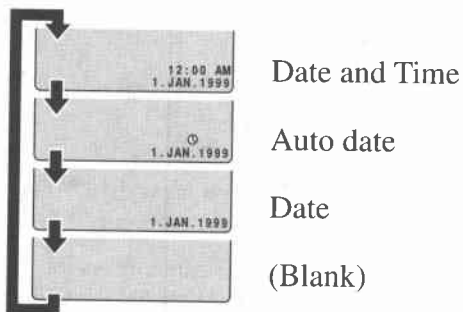

- Once the display style of the date and the time is set, it will be saved even if the power switch is changed.
- To change the date and time or the display style during operation, be sure to put the camera into record pause mode first.

**About auto date recording**

The date is automatically recorded to the tape for 10 seconds at the beginning of a day's recording.

- 1. Put the camera in record pause mode.**
- 2. Press the DATE button to set auto date recording.**
  - The mark “Ⓚ” and date appears in the display.
- 3. Press the start/stop button.**
  - The Ⓚ and date disappear 10 seconds after recording starts.

**Note:**

- Auto date is re-recorded in the following cases.
  - When a day's first recording is less than 10 seconds.
  - When the cassette has been replaced.
  - If you change the display style from, and then back to, “Ⓚ” auto date.
  - If, right after the start of recording, recording is paused then started again.
  - If the date changes during recording, i.e. at 12:00 midnight, the auto date for the new day appears the next time you stop and restart recording.
  - If the date changes within the first 10 seconds of recording, i.e. at 12:00 midnight.



## Titles

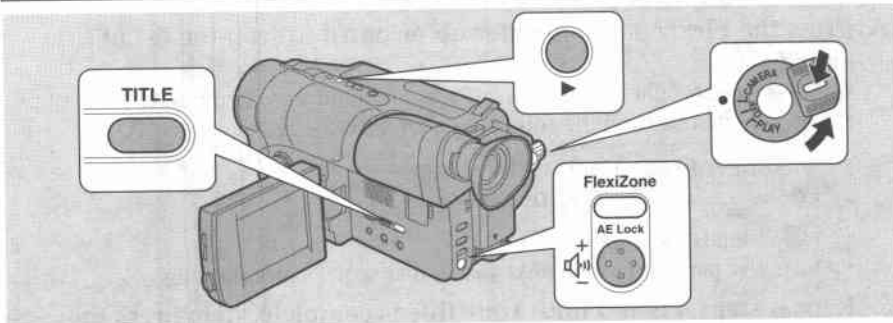

You can write your own titles and store them in the camera's memory in order to add them to your recordings.

The title appears in the display when you press the TITLE button. If you start recording now, it will be superimposed on the scene. If you start playback now, it will appear on the scene.

Press the button again to cancel the display. If it does not appear in the display, it will not be recorded.

### Writing a title

Enter your original title in the camera's memory before you start recording. Remember to install the backup battery first (see p. 67). The title can be one or two lines of up to 16 characters each.



1. Press down and turn the POWER switch to CAMERA.
2. Open the LCD screen.
3. Press and hold the TITLE button for about three seconds.
  - "■" flashes in the first space of the title line.
4. Press the FlexiZone controller to the right or left to move the cursor to the point where you want to start the title.
  - Press once to move the cursor one space at a time. Press and hold to move it quickly.

### 5. Press the FlexiZone controller up or down to scan the list of title characters.

- Press once to scan one at a time. Press and hold to scan quickly.
- You can choose from the following characters:

→ ABCDEFGHIJKLMNOPQRSTUVWXYZ ←  
 ↳ ■ &!><:+ - , / . ' ? 9876543210ËÇÑÆÅÐÜÖÅ ←

- “■” stands for a space.
  - Once you move on to the next space, that space starts flashing.
- ### 6. Repeat steps 4 and 5 until your title is complete, then press the TITLE button to enter the title in the memory.
- Press the TITLE button again to make the title disappear.

#### Notes:

- If it takes you more than about five minutes to write a title, the camera may turn itself off. This can be avoided by removing the cassette.
- Once it has been set, the title is saved in the memory even if the power switch is changed.
- You can save only one original title at a time.

### Changing your original title

1. **Press and hold the TITLE button for about three seconds.**
  - The title display flashes.
2. **Press the ► (play) button.**
  - Press once or twice until your previously written title appears.
3. **Repeat steps 4 to 6 above until your title is complete. The camera will enter your changes in its memory.**

### Quick setting of a preselected title

The camera keeps your original title and your most recently selected preset title (p. 35) in its memory and ready for quick setting.

1. **Press and hold the TITLE button for about three seconds.**
  - The title display flashes.
2. **Press the ► (play) button.**
  - Each time you press the ► (play) button, the camera alternately displays your original title and your most recently selected preset title (p. 35).
3. **Stop at whichever title you would like to be added to your tape.**
  - The title that appears in the display when you start recording or editing will be recorded onto your tape.

## Setting a preset title

E

Five titles have been preset in this camera. You can select from these to add to your recordings.

1. Turn the **POWER** switch to **CAMERA**.
2. Press and hold the **TITLE** button for about three seconds.
  - Your original title or your most recently selected preset title appears in the display.
3. Press the **▶ (play)** button.
  - Press once or twice until the preset title appears in the display.
4. Press the **FlexiZone** controller up or down to select a title.



5. Press the **TITLE** button to set the title.
  - Your selected title stays lit in the display.
  - Press the **TITLE** button again to make the title disappear.

### Note :

- If you are selecting a title during record pause, follow steps 1-4. When you press start/stop to restart recording, the title will be added to your recording.

## Searching and Reviewing While Recording

### Record search

E

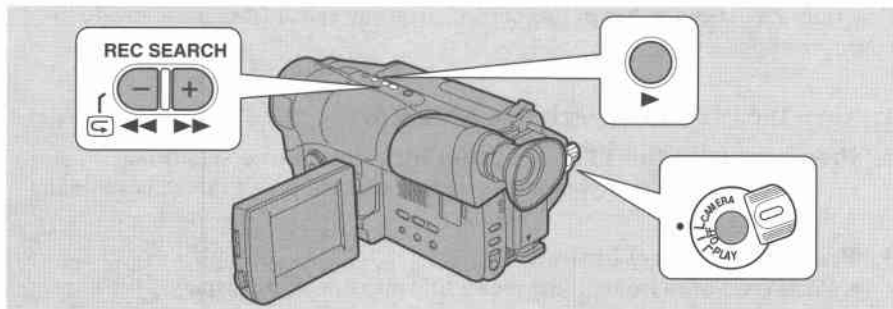

When the camera is in record pause mode, you can use record search to play the tape forwards or backwards to find the point where you want to start or restart recording. This is useful when you want to add a new scene to a previously recorded cassette. By using record search, you can ensure a smooth join between the new scene and the old one.

1. **Make sure the camera is in record pause mode.**
2. **Press and hold the ► (play) button, + (rec search) button or – (rec search) button while you check the picture in the display.**
  - The ► (play) button plays the recording normal playback. The + button plays the recording forwards and the – button plays it backwards at about three times fast forward speed.
3. **Release the button when you find the point where you want to start recording.**
  - The camera returns to record pause mode.

## Record review

E

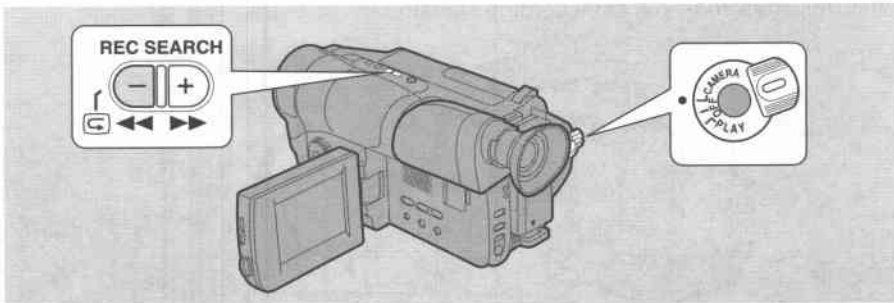

When the camera is in record pause mode, you can use record review to play back the last few seconds of your recording and then return automatically to record pause mode. You can quickly make sure that a scene has recorded properly and then go on to shoot the next scene.

**1. Make sure the camera is in record pause mode.**

**2. Press the  (rec review) button.**

- The camera rewinds the tape, plays back the last few seconds, and returns to record pause mode.

**Note:**

- Noise may appear on the screen during record search and record review.

## Using the Various Recording Programs

E

The camera provides you with a choice of six recording programs. They use different combinations of camera settings in order to adjust the exposure and other functions to match the recording situation.

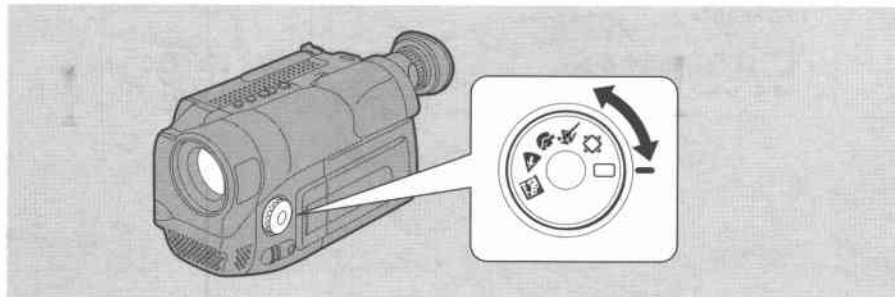

Rotate the program selector to choose the appropriate program before you start recording.

- For simple point-and-shoot operation, select the Easy Recording program. Turn the program selector to the □ position. For different recording conditions, rotate the selector to the appropriate program before you start recording. Reset to □ for standard conditions.

### Easy Recording

The simplest way to use the camera is with the program selector set to the □ position. The camera will take care of focus, exposure and other adjustments, leaving you free to point and shoot.



If you select this Easy Recording program, you cannot use digital effects.

Also, autofocus and image stabilization cannot be turned off.

### FlexiZone Recording

In normal recording conditions, set the program selector to the □ position. This is the same as the Easy Recording program, except that you can now use the FlexiZone AF (p. 45) and FlexiZone AE (p. 47).



- You can also operate the backlight compensation function (BLC) in this mode.

- While in the optical zoom range, the FlexiZone frame moves freely around the screen. However, once you enter digital zoom range, the frame becomes locked in the centre of the screen and you are unable to use AE Lock. Zoom back out from digital to optical, and the frame blinks twice, signaling that you are again free to move the frame around the screen.

## Specialised AE programs

### Sports

This program is useful for recording high-speed sports scenes in brightly lit conditions. Normal playback will be slightly jerky, but you will get clear images which can be analysed frame by frame during slow or still playback on a VCR.



### Portrait

Use this program outdoors to make the subject stand out from a softened foreground and background. It works well for still-lives and close-ups. The effect is most noticeable when the zoom position is between the middle range and the telephoto end. Focus manually for maximum accuracy.



### Spotlight

This program is designed for recording spotlit scenes, such as on a stage. The exposure is automatically adjusted for glare-free recordings of subjects lit by a concentrated light source.



### Sand & Snow

Use this program in places where the background is so bright that the subject appears underexposed in the viewfinder — a sunny beach or ski resort, for example.



### Notes:

- You can focus manually in any specialised AE program.
- Avoid changing programs during recording as the brightness of the image may change suddenly.
- The specialised AE programs are not suitable for all kinds of lighting. The image may flicker, or a bright line may appear on the screen if you use them in the wrong lighting conditions.

## Using the Digital Effects

E

### 16:9

Produces images in the 16:9 format for playback on widescreen TVs.

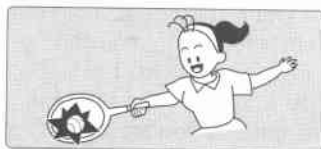

### Negative-Positive Conversion (NEG.)

Records a colour negative of the image. White appears as black, yellow appears as blue, green appears as red, etc. Also convert a negative image to an ordinary positive one.

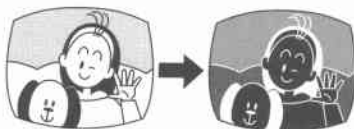

### Extra Long Digital Zoom (D. ZOOM2)

Digital high-magnification zoom increases the optical 22× zoom to up to 290×. Operate this with the zoom control.

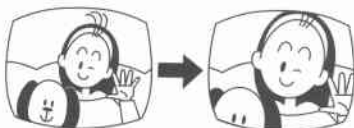

### Mirror (MIRROR)

The image will be as if you have placed a mirror in the middle of the screen.

- If you use MIRROR simultaneously with FlexiZone recording program, the FlexiZone frame can move only within the left half of the display.

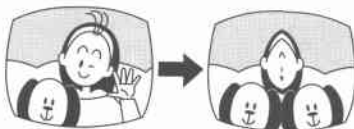

### Mosaic (MOSAIC)

Enlarges various pixels. The image is made up of noticeable squares of colour, giving a mosaic-like effect.



### Art (ART)

Adds a paint-like effect, called solarization, to the image.

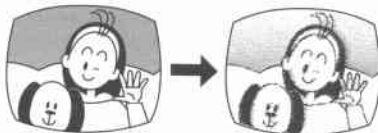



## Sepia (SEPIA)

Plays back a monochrome image with a sepia tint.

- This feature can be used only during playback

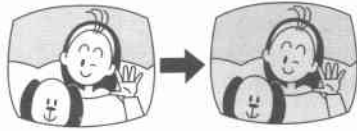

## Selecting the effect

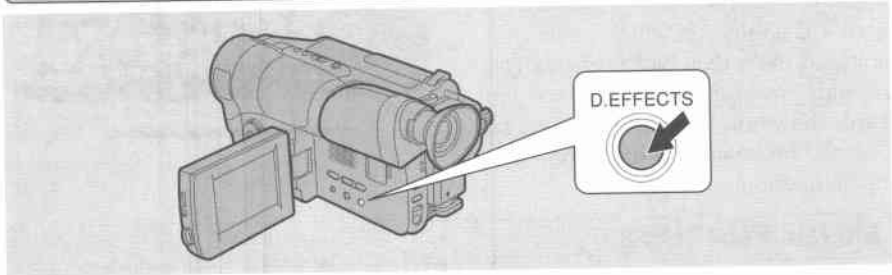

- Put the camera in record pause mode.**
  - Make sure the program selector is set to any mode but  Easy Recording.
- Press the D. EFFECTS button to choose one of the digital effects.**
  - Each time you press the button, the display changes:

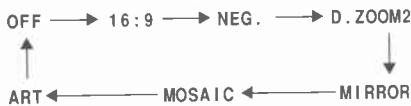

- To turn digital effects off completely, press the D. EFFECTS button until the name of the digital effects disappears from the display.
- First set the camera to pause before changing the digital effect.

### Notes:

- The effect will be cancelled if you change to the  Easy Recording program mid-recording.
- You can use the 16:9, art and sepia effects during playback or still playback modes. Press the D. EFFECTS button to select the effect.

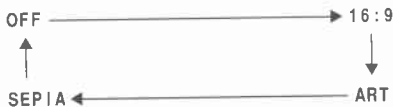

- You can use these digital effects during playback mode, however they are not recorded onto the tape. Record (dub) a digital effect onto a tape in your VCR through editing (p. 51-62).

## Using the Digital Faders

### White Fade

The display begins as a white screen, and the scene you are recording gradually appears. When you end a scene, it gradually fades to white.

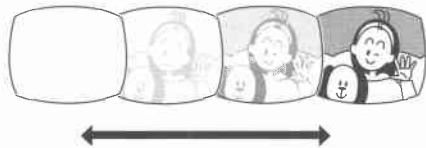

### Horizontal Wipe

When you start recording, the picture begins as a thin horizontal line in the centre of the screen which gradually expands upwards and downwards until it fills the whole screen. When you end a scene, the image is wiped from the top and bottom of the screen.

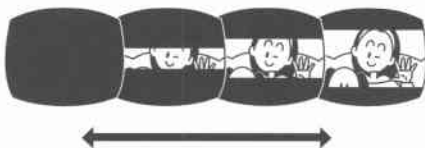

### Mosaic Fade (MOS.F)

A mosaic pattern appears and gets finer and finer, and the image and sound that you are recording gradually appear. When ending a scene, the picture that you are recording gradually turns into a mosaic pattern. This mosaic pattern gets larger and larger, and sound fades out.

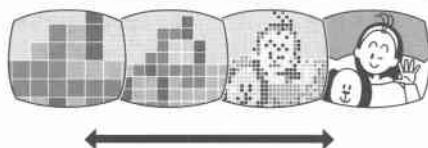

### Art Fade (ART.F)

The picture that you are recording gradually turns into a screen like an illustration, and the image and sound appear. When fading out, the picture starts as this illustration-like screen, and the image and sound gradually disappear.

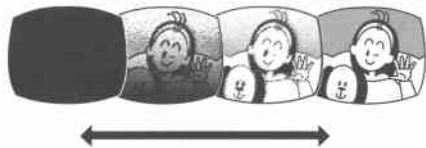

### Zoom Fade

The display starts as a telephoto close up, then zooms out to reveal your entire scene. When you end a scene, the camera zooms into the object at the centre of the display and the scene disappears.

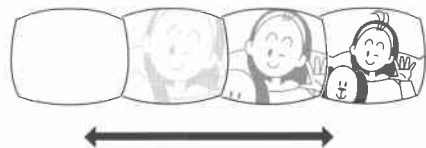

## Black & White (B/W)

Colour gradually appears in the black and white display, and sound becomes audible. When you end a scene, the colour display changes back to black and white and sound fades out.

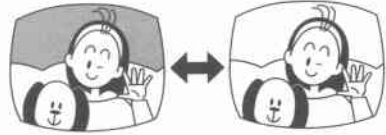

## Selecting the fader

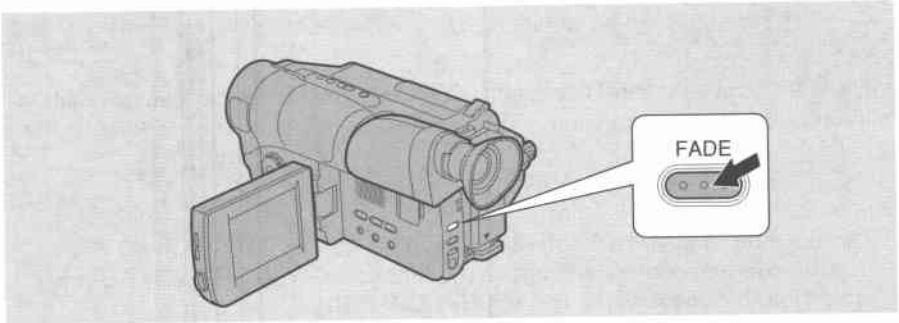

1. Put the camera in record pause mode.
2. Press the **FADE** button to choose one of the digital faders.
  - The name of the digital fader that you previously selected appears in the display.
  - Each time you press the button, the display changes:



- To turn digital faders off completely, press the **FADE** button until the name of the digital fader disappears from the display.

3. **Start or stop recording.**

- The recording will start or stop with the selected fader.
- Sound and image fade together.
- If you wish to use the fader again, press the **FADE** button again.

## Audio Recording

### External microphone

E

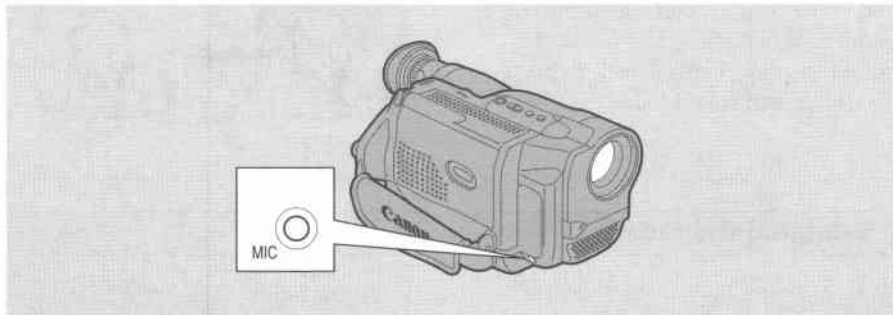

For greater creative control over audio recording, you can connect an external microphone to the camera via the MIC terminal.

#### Notes:

- Use the monaural MM-100 Mixing Microphone or the DM-300 Super-directional Microphone (both optional) with the UC-V300/UC-V200. Use a stereo microphone with the UC-V30Hi/UC-V20Hi.
  - Make sure that you use a microphone of 600 $\Omega$  impedance.
- You need the optional SA-1 Adapter Bracket to connect an external microphone to the camera.
  - Attach the Adapter Bracket after opening the camcorder's LCD panel.

## Focusing

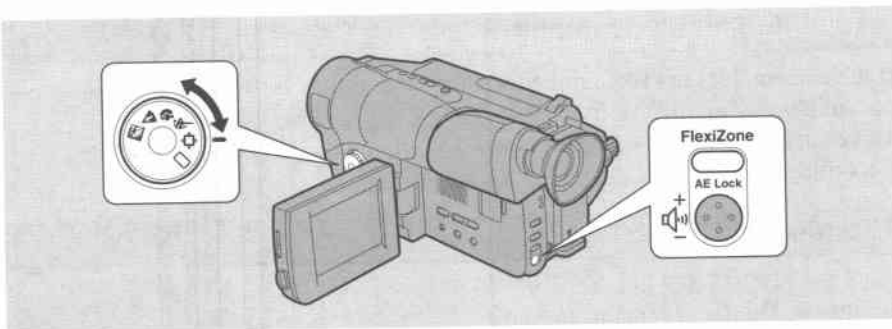

The camera can focus automatically. All you have to do is point it, and whatever is in the centre of the screen will usually be in sharp focus. It also has three functions which give you more control over focusing.

### FlexiZone AF

FlexiZone AF makes autofocus much more powerful. Using the FlexiZone controller, you can select any object that appears in the screen, and the camera will bring it into focus. Choose the FlexiZone Recording program when you want to use FlexiZone AF.

FlexiZone AF is useful in the following situations:

When your main subject is not in the centre of the screen

When you want to shoot a moving subject

It also makes it easy to use “focus shift” techniques. You can direct the viewer’s attention by focusing first on one part of the scene, and then on another.



1. Turn the program selector to .
  - The FlexiZone Control frame appears in the screen.
2. Use the FlexiZone controller to move the frame over the subject.
  - The controller can be moved in any direction. Press it repeatedly to move the frame little by little. Press and hold to move the frame quickly.
  - The camera adjusts the focus to suit the area inside the frame.
  - When you zoom into the digital range, the FlexiZone frame becomes locked in the centre of the screen. Zoom back out from digital to optical, and the frame blinks twice, signaling that you are again free to move the frame around the screen.

## Adjusting focus manually

If the camera does not seem to be focusing well, it may be because the subject is not suitable for autofocus. (p. 74)

Make sure the program selector is turned to any mode other than  Easy Recording.

## Focus lock

Press the FOCUS dial in to turn off autofocus. The focus remains locked at the point set by autofocus.

(AF OFF appears in the display.)

You can now adjust the focus manually. Press the FOCUS dial in again when you want to return to autofocus.

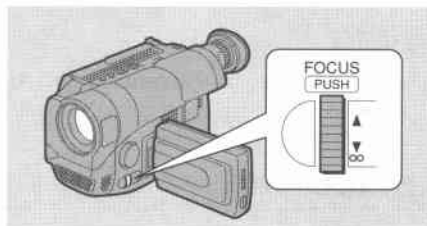

## Manual focus

Lock the focus as explained above, then use the manual focus dial to adjust the focus.

- Turn the dial upwards to bring the focus nearer.
- Turn the dial downwards to move the focus farther away.

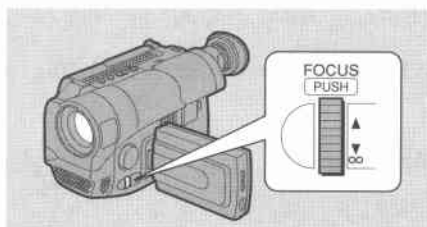

### Notes:

- If you zoom in on your subject after locking the focus, it may not stay in focus. It is generally best to adjust the zoom first, and then the focus.
- The manual focus setting is cancelled if you change the position of the POWER switch.

## Exposure

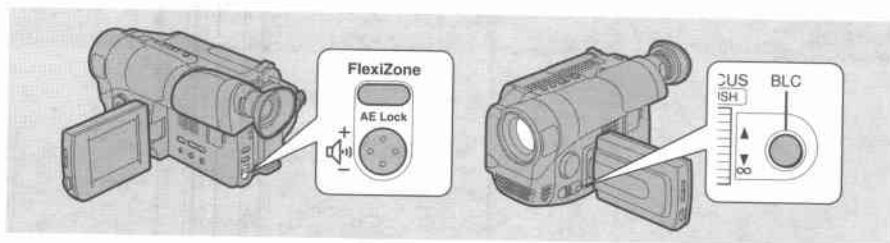

The camera adjusts the exposure automatically, making sure that your pictures are neither too dark nor too light. There is a choice of six recording programs to deal with different recording conditions (see p. 38–39).

This section explains how to use two more exposure functions. These will give you added control over your recordings.

### FlexiZone AE



The camera usually adjusts the exposure so that it is suitable for the whole scene, and especially for the area in the centre of the screen. FlexiZone AE allows you to choose any part of the scene, so that even if your subject is towards the edge of the screen, or if it is very bright or very dark, it will still be properly exposed.

- 1. Turn the program selector to  $\cdot\text{C}$  FlexiZone Recording Program.**
  - The FlexiZone control frame appears in the screen.
- 2. Use the FlexiZone controller to move the frame over the subject.**
  - The controller can be moved in any direction.
- 3. Press the FlexiZone AE Lock button.**
  - The camera adjusts the exposure to suit the area that is currently inside the frame. You can move the frame to focus on something else, but the exposure area will not move with it.
- 4. Press the button again when you want to cancel FlexiZone AE.**
  - The exposure is now adjusted to suit the centre of the screen again.
  - Press the button once more if you want to adjust the exposure for the frame's new position.
  - When you zoom into the digital range, the FlexiZone frame becomes locked in the centre of the screen and you are unable to use AE Lock. Zoom back out from digital to optical, and the frame blinks twice, signaling that you are again free to move the frame around the screen.

## Backlight compensation

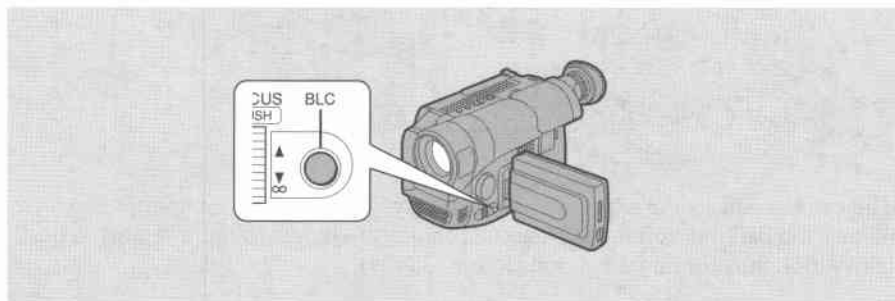

If the subject is brightly lit from behind, it may appear under-exposed and lacking in detail. To compensate for this, use the BLC function.



1. Set the **POWER** switch to **CAMERA**.
2. Press and hold the **BLC** button.
  - BLC appears in the display.
  - The BLC function will take effect as long as you hold the key down.
3. Press the **start/stop** button, and release the **BLC** button when it is no longer needed.



## Searching the Tape (Date Search)

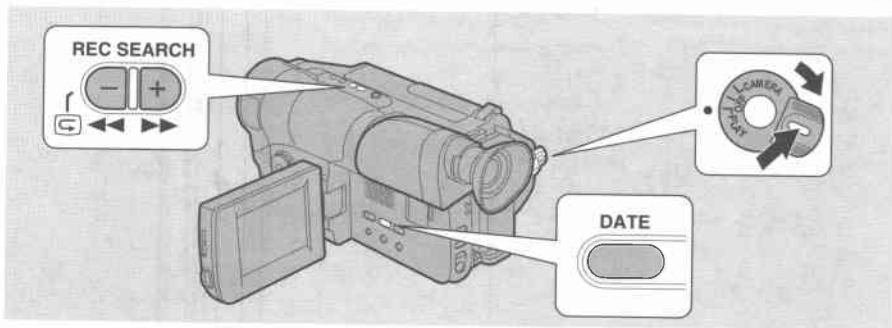

You can search for the recording start or end position of the last recorded day from anywhere on a tape.

1. Press down and turn the POWER switch to PLAY.
2. Press the DATE button.
  - SEARCH is shown in the display.

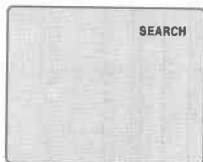

3. To search for the start of the last recorded date, press the ◀◀ (rewind) button. To search for the end, press the ▶▶ (fast forward) button.
  - ◀◀ SEARCH appears in the display when you push the ◀◀ (rewind) button and SEARCH ▶▶ appears when you push the ▶▶ (fast forward) button.
  - The tape stops automatically at the start or end of the last recorded date.
  - The screen returns to the counter display.

### Notes:

- If the date changed during recording, (when recording continued after 12 o'clock at night) the start position sets to the previous day's filming start position.
- Do any of the following to stop the on-going date search operation:
  - Push the ▶, ■, EJECT ▲ button.
  - Turn the POWER switch to OFF.
  - Push the DATE button.
- You cannot use the date search if :
  - the cassette was removed after finishing filming (recording).
  - there is no lithium backup battery in the video camera.
  - the tape was recorded using a video camera other than this camcorder.
- You can use the date search even if you have not recorded the date.
- A date cannot be identified if the total recording time on that day was less than 30 seconds.

## Using the PAL 60 System

E

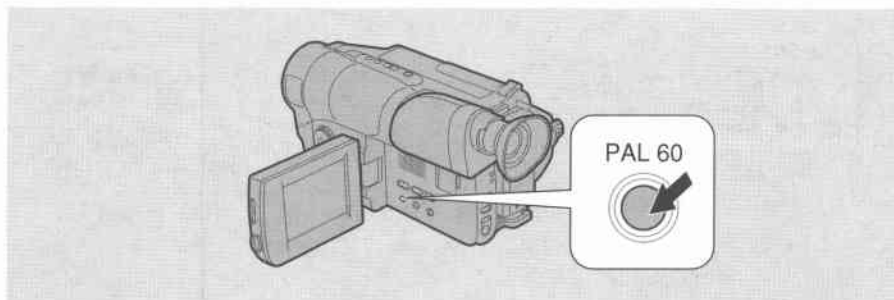

This camcorder uses the PAL system for recording and playing back tapes. However, it can convert the signal format of a tape recorded on the NTSC system, allowing you to view it on a television operable on 60Hz.

- Check whether the television can be set to PAL 60 mode.
- This function can only be used for playback. You cannot use the editing function while in PAL 60 mode.

### 1. Connect the camera to TV.

- See "Connections for Playback on a TV Screen" on p. 22.

### 2. Turn the TV on and set it to PAL 60 mode.

- See your TV instruction manual for details.

### 3. Load the NTSC cassette.

### 4. Press down and turn the POWER switch to PLAY.

### 5. Push the PAL 60 button.

- PAL60 appears in the display.



### 6. Push the ► (play) button.

#### Notes:

- You cannot view a cassette recorded by the ordinary PAL system with the PAL 60 function on.
- When a cassette recorded in NTSC format is played back in your camcorder in PAL 60 mode, the pictures in the viewfinder and on the LCD will not appear normally.
- The camera sometimes might not operate correctly, due to the condition of the recorded cassette, even if it switches properly to PAL 60.
- You cannot use the PAL 60 system with an RF unit connected your camera.

# The Auto Editing Function

Using the Auto Editing Function is simple. Just watch your original tape and press the EXECUTE button on the wireless controller (or the FlexiZone AE Lock button on the camera body) at the beginning and the end of each scene you want to record.

This creates an editing program. Start the program, and the camcorder automatically records the scenes you selected onto the tape in your VCR. Before you record, you can preview everything (p. 56), change the point where a scene begins or ends (p. 61), and even delete (p. 59) or re-order scenes (p. 60).

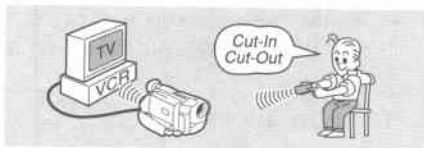

1. Prepare the camera. Connect the video cables, and place it so that it can control your VCR by remote control.
2. Watch the video. When a part you want to keep starts, press the EXECUTE button on the wireless controller (or the FlexiZone AE Lock button). Press the button again at the end of the part you want to keep. You can choose up to six scenes this way.

Original tape in Camera

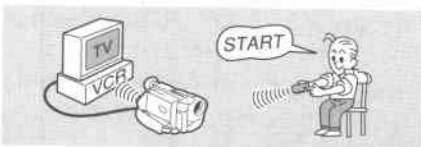
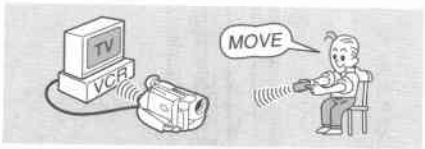

3. If you wish, preview the video. You can also re-order scenes, change the time they start and finish, or even delete them.
  - To select a function, a scene, or a time, or to move a scene, use the ▲, ▼, ►, ◀, arrow keys on the wireless controller (or the FlexiZone controller). To activate a function use the EXECUTE button (or the FlexiZone AE Lock button).
4. When everything is perfect, automatically record it to the VCR. Choose START from the bottom of the screen, then press the EXECUTE button (or the FlexiZone AE Lock button).

Final tape in VCR

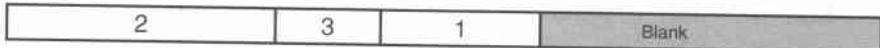

## Preparing for Editing

The camera's Auto Editing Function enables you to smoothly rerecord scenes from an original tape in any order. You can then view the entire finished product and make all the fine adjustments you want before the final recording. It is easy to reorder or re-adjust scenes, to make your videos perfect.

- 1. Connect the camera to the VCR.**
  - See the "Connections for Playback on a TV Screen" instructions on page 22.
- 2. Turn the TV on.**
  - Be sure to set it to the video channel, or set the TV/Video selector to Video.
- 3. Turn on the VCR and load a blank cassette.**
  - See your VCR instruction manual.
- 4. Set the POWER switch to PLAY and push the EDIT button on the camera body.**
  - All displays are also displayed on the screen of the TV attached to your VCR. However, these displays will not be recorded onto the tape in the VCR.

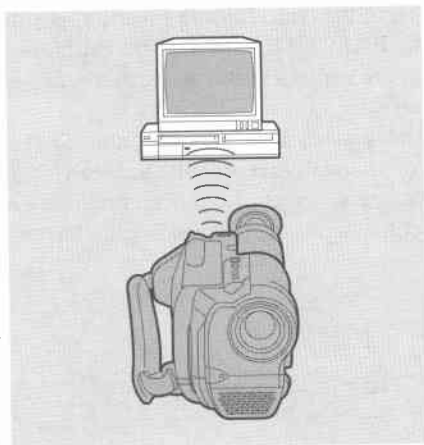

### Setting the camera to control your VCR

The camcorder's Auto Editing Function controls your VCR by using the same infra-red signals as the VCR's remote control.

Make sure the camera is in a spot where it can remotely control your VCR.

- 1. Check where the remote control sensor is on your VCR using its normal remote control.**
- 2. Place the camera pointing directly at the sensor, not more than 50 cm away.**
  - Check that the sensor will pick up signals easily from this spot using the VCR's normal remote control.
  - Make sure that the cables and the camera strap do not obstruct the signals.
- 3. Make sure that the VCR is in record pause mode.**
- 4. Make sure that all other video equipment is turned off to avoid accidental recording.**

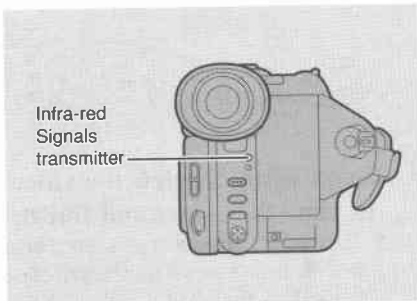

## Cut-In and Cut-Out Adjustments

The point where a scene starts is called the “cut-in” point, and the point where it ends is called the “cut-out” point.

Some VCR models take a second or more to actually start recording after they receive the command signal. If this happens you could lose the beginning of the scene. CUT IN ADJ prevents this by sending the command a little early.

Similarly, some models take some time to react to the command to stop recording. Some models also rewind slightly after they stop. You could therefore record more than you wanted, or lose the end of the scene. CUT OUT ADJ prevents this, by sending the command a little early or late.

If you have these problems with your VCR, reset these adjustments.

### How to calculate the best adjustment for the “cut-in” and “cut-out” points

1. Set the camcorder and VCR up as in “Preparing for Editing,” and “Setting up the camera to control your VCR,” p.52-53. Also make sure you have the second editing screen (shown right).
2. Point the arrow to VCR.
3. Press the EXECUTE button (or the FlexiZone AE Lock button).
  - The VCR records the screen for 10 seconds, then pauses.
  - As it does, the words “CUT OUT” are displayed. Next to this there is a digital timer, accurate to one-tenth of a second. The timer counts down from +5.0 to -1.0 seconds. At precisely 0.0 seconds, the camera sends the message to pause.
4. Wait for a few moments.
  - The VCR starts to record again, then stops.
  - This time, the words “CUT IN” and a timer are displayed. The timer counts from 0.0 to -5.0 after the camera sends the message to start recording.
5. Repeat steps 3 and 4 at least twice more.
  - This way you should have at least three recordings of the CUT IN and CUT OUT timers.
6. Rewind the VCR tape and play back the recordings of the menu and the timers.
  - Look at the time the CUT OUT timer stops and CUT IN timer starts. These times are what the CUT OUT ADJ and CUT IN ADJ settings should be.
  - For maximum accuracy, take an average of at least three readings.
  - If your VCR has a frame advance function or a jog dial, use it to find the precise starting times most conveniently.

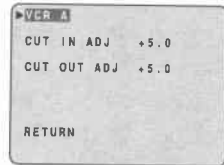

**7. Point the arrow at CUT IN ADJ with the ▲ / ▼ keys (or the FlexiZone controller).**

- Point it at “CUT OUT ADJ” to set the cut-out adjustment.

**8. Adjust the setting with the ◀ / ▶ keys (or the FlexiZone controller).**

- CUT IN ADJ can be set up to 5 seconds early. (-5.0)
- CUT OUT ADJ can be set from one second early to five seconds late. (-1.0 to +5.0)
- This can be set to an accuracy of one-tenth of a second.

**Note:**

- The camcorder will remember the cut-in and cut-out adjustment settings until you change them.

# Deleting Scenes and Clearing the Program

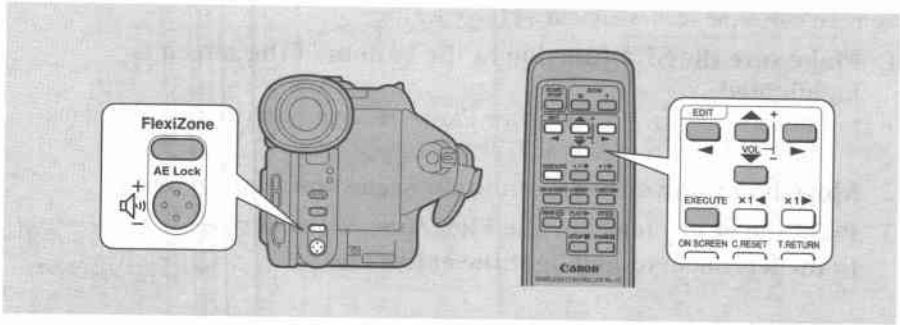
**E**

## Deleting a scene (DEL function)

You can delete a scene from the program.

1. Use the arrow keys (or the FlexiZone controller) to move down the screen to the bottom line, and then across to the DEL function.
2. Use the ▲ / ▼ keys (or the FlexiZone controller) to move directly up the screen to highlight the scene you want to delete.
3. Press the EXECUTE button (or the FlexiZone AE Lock button).
  - The scene is deleted and that line is now blank.
  - You can insert a new scene here if you wish, using the SET function as described in “Choosing a Scene” (p. 55).
  - If this line is left blank, it will not affect the rest of the recording, and the next scene will smoothly follow the previous one.

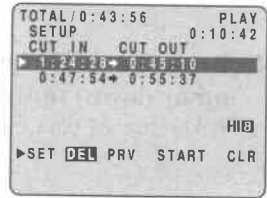

## Clearing the whole display (CLR function)

This deletes the whole program.

1. Use the arrow keys (or the FlexiZone controller) to move down the screen to the bottom line, and then across to the CLR function.
2. Press the EXECUTE button (or the FlexiZone AE Lock button).
  - All the lines are now blank. All data is deleted.
  - Please do not do this by mistake, or you will have to start again from the beginning.

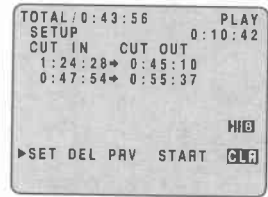

Editing

## Reordering Scenes

You can move the scenes around and reorder them.

**E**

1. Make sure the SET function at the bottom of the screen is highlighted.
  - If not, use the arrow keys (or the FlexiZone controller) to move down the screen and then across to SET.
2. Move up or down the screen to the scene you want to move.
3. Press the ◀ key once (or the FlexiZone controller to the left once) to highlight the entire line.



4. Press the ▲ / ▼ keys (or the FlexiZone controller up or down) to where you want it.
  - The line of data moves with it.

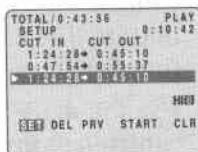

5. Press the ▶ key, or the FlexiZone controller to the right (or press the FlexiZone AE Lock button) to fix the data in place.
6. Repeat as necessary with the other scenes until the program is ordered as you want it.



## Editing Scenes

### Changing the point where a scene starts or ends ("cut-in" / "cut-out" point) – SET function

**E**

1. **Make sure the SET function at the bottom of the screen is highlighted.**
2. **Move up or down the screen to the scene you want to alter.**
3. **Press left or right until the time you wish to change is highlighted.**

- If not, use the arrow keys (or the FlexiZone controller) to move down the screen and then across to SET.

▶ 0:24:28 + 0:45:10

- Press right again, and the "cut-out" point is highlighted.

▶ 0:24:28 + 0:45:10

- Press right once more, and the whole line is highlighted. Use this if you want to move the line, without changing the times (see "Reordering Scenes" p. 60.)

▶ 0:24:28 + 0:45:10

- Press right again, and none of the line is highlighted.
  - Press left to go through the same sequence in reverse order.
4. **Use the playback keys as normal to operate and play the tape again. (First rewind or fast forward if necessary.)**
  5. **Press the EXECUTE button (or the FlexiZone AE Lock button) to indicate where you now want the scene to start or end.**
    - This position according to the counter will be displayed in the screen.

## Simple Editing to a VCR

If you cannot find the appropriate setting for the camcorder to remotely control your VCR, you still can edit a tape to the VCR as follows.

**E**

### Preparations

- 1. Connect the camera to the VCR.**
  - See "Connections for Playback on a TV Screen" on p. 22.
- 2. Prepare the TV and VCR.**
  - Turn on the TV and set it to the video channel, or set the TV/VIDEO selector to VIDEO.
  - Turn on the VCR, and set its input selector to LINE. Load a blank cassette, and put the VCR in record pause mode.
  - See your TV and VCR instruction manuals for details.
- 3. Turn the camera's POWER switch to PLAY, and load your recorded cassette.**

### Basic editing

- 1. Find a point on your prerecorded cassette slightly before the section you want to copy.**
- 2. Start to play it back while you monitor the picture on the TV.**
- 3. Start recording on the VCR as soon as the section you want to copy appears on the screen.**
- 4. Pause the VCR at the end of the section you want to copy, then stop playback on the camera.**
- 5. Repeat steps 1 to 4 until your edited recording is complete.**

## Preparing the Camera

### Prepare the lens cap

- Attach the cord to the lens cap, and pass the grip belt through the loop on the cord.
- Hook the lens cap on to the grip belt while you are recording, and place it over the lens when you have finished.

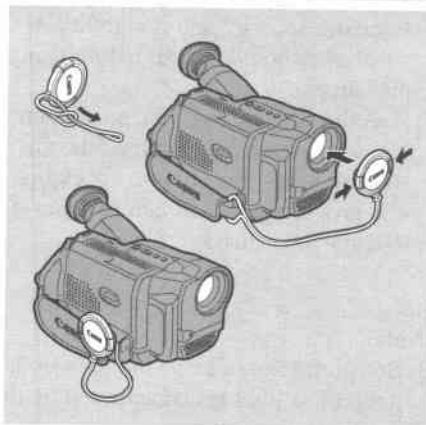

### Fasten the grip belt

- Release the Velcro fastening and hold the camera with your right hand while you adjust the belt with your left.



### Adjust the viewfinder

- Turn the camera on, pull the eyepiece straight out until it stops, raise the viewfinder and turn the viewfinder focusing wheel until the viewfinder displays are clearly focused.
- The viewfinder rotates through 90° to give a choice of shooting positions. Store the camera with the viewfinder in its retracted and lowered position.
- To view recording with the viewfinder, make sure the LCD panel is either turned in the direction of the lens, or totally closed with the screen facing inwards.

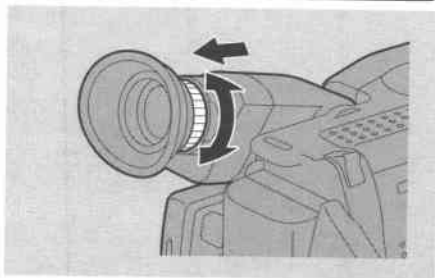

## Attach the shoulder strap

- For extra security and portability, attach the shoulder strap before using the camera.
- Pass the ends through the attachment bars and adjust the length as shown.
- Be sure to test the strap to check that it is properly attached before using it to carry the camera.

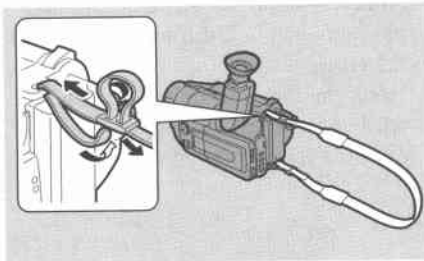

### Note:

- Be careful not to leave the viewfinder exposed to bright sunlight, or it will melt. (The light is concentrated by the viewfinder lens.) Always return the eyepiece to its retracted position when not in use.

## Preview and Recording

E

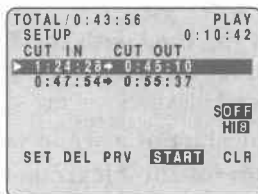
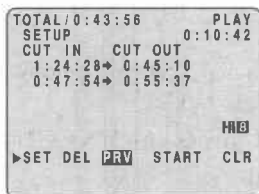
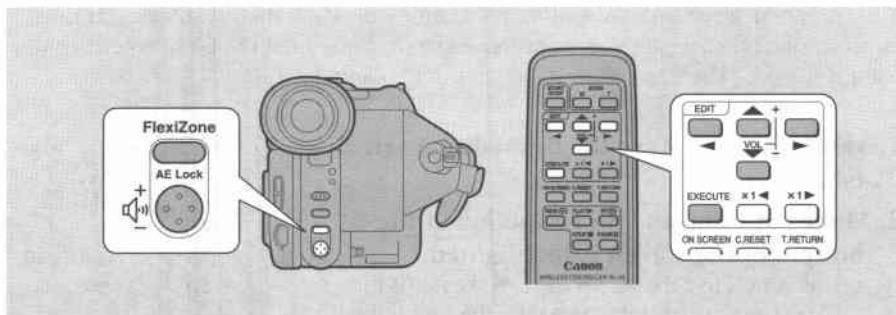

### Previewing the editing program (PRV function)

You can preview the editing program. The preview function plays the whole program, automatically pausing at the “cut-in” and “cut-out” of each scene to help editing.

1. Use the arrow keys (or the FlexiZone controller) to move down the screen to the bottom line, and then across to the PRV function.
2. Press the EXECUTE button (or the FlexiZone AE Lock button).
  - The camera will now play all the scenes in the order you have programmed them.
  - In PRV mode the tape starts a little before each “cut-in” point. It will pause for two seconds precisely at the “cut-in” point. It pauses again at the “cut-out” point.

### Running the editing program (START function)

1. Make sure the VCR is ready to record and on pause.
2. Use the arrow keys (or the FlexiZone controller) to move down the screen to the bottom line, and then across to the START function.
3. The editing program starts when you press the FlexiZone AE Lock button.
  - The camera automatically records the scenes you selected onto the tape in the VCR.
  - You are now unable to use the wireless controller (S OFF (sensor off) appears in the display).

## Choosing a Scene

You can put a scene into the editing program by pressing the FlexiZone AE Lock button at the point where you want the scene to start and at the point where you want it to end. (The “cut-in” and the “cut-out” points.)

E

1. **Make sure you have the first editing screen (shown right).**

2. **Make sure that the SET function at the bottom of the screen is highlighted.**

- If it is not, use the ▲, ▼, ►, ◀, keys (or the FlexiZone controller) to change the highlighted function to SET.

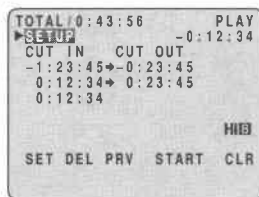

3. **Start the tape with the ► (play) button.**

- You can use the ►, ◀◀, ►►, II, ■, ×1◀(\*1) and ×1►(\*2) buttons or special playbacks in the same way as in playback mode.

4. **At the start of a scene you want to record, press the EXECUTE button (or the FlexiZone AE Lock button).**

5. **Press it again at the end of the scene.**

- The beginning and end of the scene according to the counter (the “cut-in” and “cut-out” points) are displayed on the screen.
- The camera will not let you put in a “cut-in” point later than its “cut-out” point, nor a “cut-out” point earlier than its “cut-in” point.
- You will not be able to make scenes shorter than about two seconds in length.

6. **You can program the Auto Editing Function to remember up to six different scenes in the same way.**

### Note:

- TOTAL at the top of the menu tells you the total running time of all the scenes you have selected.

For best results, when editing from the start of the tape, let the tape run for about 20 seconds according to the counter. Set the first cut-in point after that. Also, avoid setting the last cut-out point in the last ten seconds of the tape.

\*1 **Reverse ×1 ◀ playback**

For convenient normal speed reverse playback, press and hold the ×1 ◀ button on the wireless controller during still playback. Release to return to still playback.

\*2 **Forward ×1 ► playback**

For convenient normal speed playback, press and hold the ×1 ► button on the wireless controller during still playback. Release to return to still playback.

The soundtrack cannot be heard during forward ×1 ► and reverse ×1 ◀ mode.

## Using the Editing Function for the First Time

When you use the editing function for the first time, or with a different VCR, you should set your camcorder to send the correct remote control signals to your VCR.

The camera will not forget this setting unless you change it. Do not alter it again unless you change VCRs.

**E**

### Preparations & Setting up

1. Make sure that the camera and VCR are set up as in “Preparing for Editing,” and “Setting up the camera to control your VCR,” p. 52. Also make sure you have the first editing screen (shown right).
2. Using the ▲ / ▼ keys (or the FlexiZone controller), point the arrow at SETUP.
3. Press the EXECUTE button (or the FlexiZone AE Lock button) to enter the second editing screen.
4. Point the arrow to VCR.

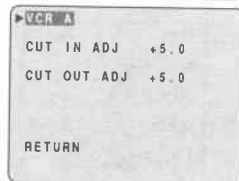
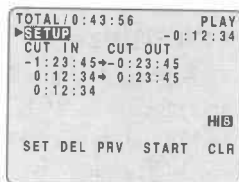

### Setting your brand of VCR

Use the chart on p. 54 to find the settings for your brand of VCR. Make sure the camcorder's infra-red control signals can reach the VCR, and the VCR is in record pause mode. (Ready to record and on pause.)

1. Set VCR to the first setting for your brand of VCR.
  - For example, 7-A if you have a JVC VCR.
  - Use the ► key (or press the FlexiZone controller to the right) to change the setting.
2. If the setting is correct, the VCR will start recording automatically.
  - As long as the camera is pointing at the VCR's remote sensor while you change the setting.
3. If the VCR does not start recording, try the next setting.
  - Use the ◀ / ▶ keys (or press the FlexiZone controller sideways) to proceed to 7-B in the above example.
  - Try each setting in turn until the VCR starts to record.
4. Depending on the brand of VCR, the signals to start and pause may differ. Once the VCR starts to record, check that the setting is right. Put the VCR on record pause again, then press the EXECUTE button (or the FlexiZone AE Lock button).

**Editing**

- The VCR should start to record for a few seconds, and REC appear in the display and on the TV screen. Then it will automatically pause and PAUSE appear in the display and on screen.
- If not, then the setting is still not right. Try the next setting.

**5. To exit, move down to RETURN and press the EXECUTE button (or the FlexiZone AE Lock button). (To totally exit the Editing Function, press the EDIT button.)**

### VCR Settings

The camera's Auto Editing Function can remotely control almost all brands and models of VCR. VCR remote control signals vary depending on model and brand. First, choose the right setting for your VCR. The number indicates the VCR brand. The letter indicates the set of signals.

Brand	Settings	Brand	Settings	Brand	Settings
Canon	1-A to 1-B	Pioneer	11	Thomson	18-A to 18-C
Aiwa	2-A to 2-C	Sanyo	12-A to 12-C	Saba	
Akai	3-A to 3-C	Fisher		Nordmende	
Fujitsu	4	Sharp	13-A to 13-C	Ferguson	19-A to 19-C
Funai	5	Sony	14-A to 14-F	Grundig	20-A to 20-C
Hitachi	6-A to 6-B	Toshiba	15-A to 15-B	Nokia	21-A to 21-C
JVC	7-A to 7-C	GE	16-A to 16-B	Telefunken	22-A to 22-B
Mitsubishi	8-A to 8-D	RCA		Zenith	23
NEC	9-A to 9-D	Magnavox	17-A to 17-B	Samsung	24-A to 24-B
Panasonic	10-A to 10-G	Philips	18-A to 18-C	GoldStar	25
Blaupunkt		Seleco			
Quasar		Rex			

as of May 1999

#### Notes:

- Once you find the correct setting, do not change it unless you change VCRs.
- See p. 57 for details of the "cut-in" and "cut-out" adjustments.
- If you try all the numbers and letters, but the VCR has still not started to record:
  - Check that the VCR is ready to record, and on pause.
  - Check that the VCR can receive signals from where the camera is, and that nothing is blocking the signals.
  - Go back and try to set it again.

- If your brand of VCR is not on the chart, or you cannot find the correct setting, try all the numbers with the ◀ / ▶ keys (or the FlexiZone controller) until the VCR starts to record.
- It is unlikely, but you may have a VCR the Editing Function cannot control. If so, use the Simple Editing method on p. 62.



# Notes on Using the Batteries

## Charging and recording times

### Time required for full recharge

BP-915	3 hr. 15 min.
BP-930	5 hr. 30 min.
BP-930R	5 hr. 20 min.
BP-941	8 hr. 35 min.

### Maximum recording time

		BP-915	BP-930/BP-930R	BP-941
UC-V30Hi	Using LCD screen	1 hr. 40 min.	3 hr. 35 min.	4 hr. 40 min.
	Using viewfinder	1 hr. 55 min.	4 hr. 05 min.	5 hr. 20 min.
UC-V20Hi	Using LCD screen	1 hr. 45 min.	3 hr. 40 min.	4 hr. 45 min.
	Using viewfinder	1 hr. 55 min.	4 hr. 05 min.	5 hr. 20 min.
UC-V300	Using LCD screen	1 hr. 45 min.	3 hr. 40 min.	4 hr. 45 min.
	Using viewfinder	1 hr. 55 min.	4 hr. 05 min.	5 hr. 20 min.
UC-V200	Using LCD screen	1 hr. 50 min.	3 hr. 55 min.	5 hr. 05 min.
	Using viewfinder	2 hr. 05 min.	4 hr. 25 min.	5 hr. 50 min.

\* The BP-915 Battery Pack is supplied and the other BP-900 series Battery Packs are optional.

- When you use the optional CH-900 Dual Battery Charger/Holder with two battery packs attached, maximum recording time will be almost doubled. For example, when you attach two BP-941 battery packs, the UC-V30Hi/UC-V20Hi/UC-V300 can record up to 11 hours and the UC-V200 up to 12 hours continuously.
- These times vary — the safest policy is always to have two or three times as many battery packs as you think you will need.
- You will get more recording time if you turn the camera off between shots, instead of leaving it in record pause mode.
- Recording time will be shorter than usual at low temperatures. You can use the battery pack between 0° to 40°C (32° and 104°F), but it works best between 10° to 30°C (50° and 86°F). At locations with extremely low temperatures such as ski resorts, a warning display might sometimes appear for about five minutes after starting use.
- If the battery pack starts to give you much less recording time than usual, it has reached the end of its life and must be replaced.

## How much power is left?

The indicator in the display shows you approximately how much charge the battery pack has left (when a battery pack is directly attached to the camera):

### Notes:

- The  mark starts blinking in the display when the power is completely exhausted.
- The indicator is not constant — different levels will be shown when you subject the battery pack and camcorder to different conditions.

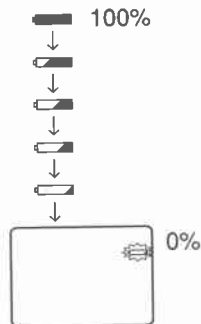

## Remaining time indicator

Tells you how many minutes of power remain in the battery pack. Only appears when you attach the BP-930R battery pack directly to the camera. (It doesn't appear if you use the CH-900 Dual Battery Charger/Holder.)



## When to recharge

You can recharge a lithium ion battery pack whenever it is convenient. Unlike a conventional battery pack, it does not have to be fully discharged first. However, as the battery pack will naturally discharge itself over time, it is best to charge it the same day you plan to use it, or the day before.

## Taking care of the battery pack

**E**

### Always attach the terminal cover.

- Do not allow any metal objects to touch the terminals, as this can cause a short circuit and damage the battery pack. Attach the terminal cover whenever the battery pack is not being used.

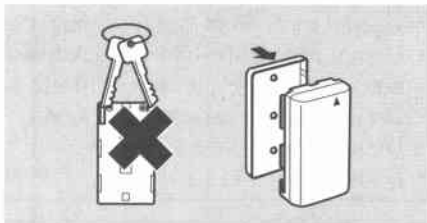

### Keep the terminals clean.

- The camera, adapter or battery pack will not work properly if the terminals are dirty. Check them before use, and wipe them with a dry cloth or tissue if necessary.

### Storing the battery pack.

- If you do not use a battery pack for a period of more than a few months any remaining charge may cause damage to the battery pack, and reduce usage time. To prevent damage therefore, aim to use a battery pack's complete charge before storage.

## Installing the backup battery

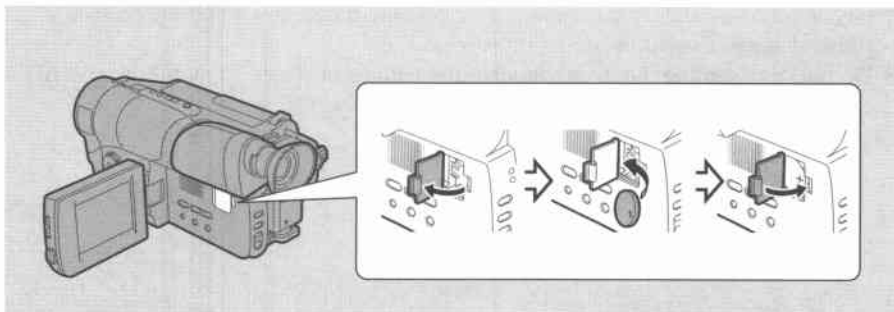

When the backup battery needs replacing, the mark  flashes in the display. When replacing the backup battery, make sure to attach a power source to the camera before turning the camera off. This way the camcorder will remember your chosen settings while you change the backup battery.

Open the battery cover from the side of the camera, and insert the CR2025 lithium battery with the + side facing outwards. Close the cover back into place.

This backup battery allows the camera to remember the date and time and other settings when the main power source is removed. It has a life span of about a year.

- Remove the backup battery by using a non-metal tool such as a toothpick. Push the battery in to the left then release and lift out.

Do not use tweezers or other metal tools – this will cause a short circuit.

**E****DANGER!****Treat the battery pack with care.**

- Keep it away from fire (or it might explode).
- Do not expose the battery pack to temperatures greater than 60°C (140°F). Do not leave it near a heater, or inside a car in hot weather, for example.
- Do not try to disassemble or modify it.
- Do not drop or knock it.
- Do not get it wet.

**WARNING!**

- The battery used in this device may present a fire or chemical burn hazard if mistreated. Do not recharge, disassemble, heat above 100°C (212°F) or incinerate.
- Replace the battery with a Sony, Sanyo or Panasonic CR2025, or Duracell DL2025. Use of another battery may present a risk of fire or explosion.
- The used battery should be returned to the supplier for safe disposal.

**Cautions:**

- Do not pick up the battery using tweezers or other metal tools—this will cause a short circuit.
- Wipe the battery with a clean, dry cloth to ensure proper contact.
- Keep the battery pack out of reach of children—if it is swallowed, contact a physician immediately, as the battery case may break down and the battery fluids damage the stomach and intestines.
- Do not disassemble, heat, or immerse the battery in water, to avoid the risk of explosion.

# Maintenance

## Cautions

E

### **Avoid high temperatures and high humidity.**

- Do not leave the camera inside a car in hot weather, for example.
- Be careful of heat radiating from video lighting equipment.
- Do not take the camera into a humid room.

### **Avoid sudden changes in temperature.**

- If you take the camera from a cold place to a warm place, condensation may form on the lens and internal parts (see p. 72).

### **Do not point the lens or viewfinder at strong light sources.**

- Never point it at the sun, and do not leave it aimed at a bright subject.
- Be especially careful when leaving the camera on a tripod.

### **Avoid magnetic or electric fields.**

- Do not use the camera close to TV transmitters, portable communication devices or other sources of electric or magnetic radiation. They may cause picture interference, or permanently damage the camera.

### **Do not expose the camera to water.**

- Cover the camera when you are recording in rain or mist.
- There is a risk of electric shock if water gets inside the camera — contact qualified service personnel as soon as possible.

### **Protect the lens.**

- Sand and dust can damage the lens — be especially careful on windy days.

### **Handle the camera gently.**

- Vibration or shock can cause damage.
- Do not use the viewfinder or LCD panel as a carrying handle.

### **Do not disassemble the camera.**

- This is very dangerous as there is a risk of electric shock — if the camera does not function properly, take it to qualified service personnel.

## Storage

If you do not intend to use the camera for some time, store it in an area which is free of dust and moisture, and where the temperature is no higher than 30°C (86°F). After storage, check each part and function of your camera to make sure everything is still working properly.

### **Note:**

- These cautions also apply to accessories such as battery packs and cassettes.

## Maintenance

E

### LCD

- Clean the LCD screen using a commercially available glass cleaner.
- Where there is a big change in temperature, moisture may form on the surface of the screen. Wipe clean with a soft, dry cloth.
- At low temperatures the display may appear to be much darker than usual. This is not a fault, and as the screen warms up the display will return to normal.

### Viewfinder

- Clean the viewfinder screen using a blower brush. First, remove the eyepiece: pull the eyepiece out to the line, then turn it anticlockwise and pull it out. To reattach it, insert it up to the line, turn clockwise and press it on until it clicks back into place.



### Camera body and lens

- Use a soft, dry cloth to clean the camera body or lens. Never use chemically treated cloth or volatile solvents such as paint thinner.

### Video heads

- Clean the video heads using Canon's CC-8 Video Head Cleaning Cassette.
- Do not use a wet-type cleaning cassette, as this can cause damage.



## Using the camera abroad

**E**

### Power sources

- You can use the compact power adapter to operate your camera and charge battery packs in any country where the electricity supply is between 110 and 240 V AC, 50/60 Hz. Contact your Canon dealer for information about plug adapters for overseas use.

### TV playback

- Although you can always play back your recordings on the LCD screen, your camera can only be connected to TVs which use its PAL system. This TV system is used in the following countries:  
Algeria, Australia, Austria, Bangladesh, Belgium, Brunei, China, Denmark, Finland, Germany, HongKong, Iceland, India, Indonesia, Ireland, Italy, Jordan, Kenya, Kuwait, Liberia, Malaysia, Malta, Mozambique, the Netherlands, New Zealand, North Korea, Norway, Oman, Pakistan, Portugal, Qatar, Sierra Leone, Singapore, South Africa, Spain, Sri Lanka, Swaziland, Sweden, Switzerland, Tanzania, Thailand, Turkey, Uganda, United Arab Emirates, United Kingdom, Yemen, former Yugoslavia, Zambia.
- You can view NTSC tapes with this camera if you connect it to a television that can operate on 60 Hz (p. 50).

## Condensation

Condensation may form on the camera when it is moved from a cold place to a warm place. Using the camera while condensation is present can damage both the tape and the camera.

Condensation may become a problem:

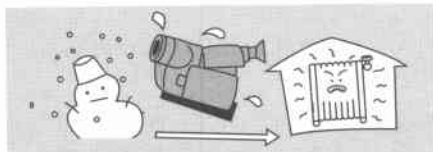

When you take the camera from a cold place to a warm room



When a cold room is heated rapidly

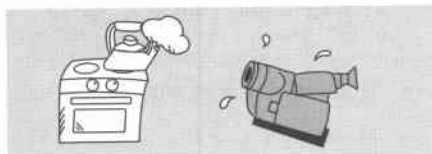

When the camera is left in a humid room

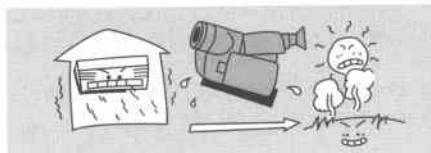

When the camera is taken from an air-conditioned room to a warm, humid place

### Protecting the camera from condensation

- Before you take the camera to a warm or humid place where condensation is likely to be a problem, unload the cassette and put the camera in a plastic bag. Wait until the camera reaches room temperature before you take it out of the bag.
- When the surface of the video camera is wet, do not use it. Wait for hours until the whole video camera dries.

### What happens when condensation is detected

- TAPE flashes in the display. If there is a cassette in the camera, immediately remove the cassette, put it back in its container and place the cassette container opened in a dry location. If condensation has formed on the camera, only the POWER switch and EJECT  button function.

### What you should do

- Remove the cassette, leave the cassette compartment open, and turn the camera off.
- Leave it in a dry place until the condensation evaporates. After the condensation warning stops flashing, wait at least another hour before trying to use the camera.



## Troubleshooting

Refer to this checklist first if you have any problems with your camcorder. Possible explanations are given for each problem on the list — turn to the page numbers in parentheses for more information.

E

Make sure that the camera is properly connected if you are using it with a TV or VCR. Consult your dealer or service outlet if problems persist.

### Recording/Playback

#### Problem

#### Cause and/or what to do about it

❑ **Nothing happens when I press the buttons.**

- The camera is not switched on (p. 11, 18).
- The cassette is not loaded or is set for erasure prevention (p. 9-10).
- The tape has reached the end.
- The battery pack is exhausted or not properly attached (p. 6, 7, 65).

❑ **The camera turned itself off.**

- The camera was in record pause mode for more than about five minutes (p. 11).
- The battery pack is exhausted (p. 7).

❑ **The start/stop button doesn't work.**

- The POWER switch is not set to CAMERA (p. 11).
- The cassette is not loaded or is set for erasure prevention (p. 9-10).
- The tape has reached the end.

❑ **There's no picture in the display.**

- The POWER switch is not set to CAMERA (p. 11).

## 2 The camera won't focus.

- The camera is on manual focus (p. 46).
- The viewfinder lens needs adjusting (p. 63).
- The lens is dirty (p. 70).

### Note:

- Some subjects are not suitable for autofocus. In these situations, you will often get better results using manual focus (see p. 46). Focus on something which is about the same distance away, lock the focus, and then point the camera at your original, hard-to-focus subject.



Horizontal stripes



Many subjects at different distances



Behind glass



Without much contrast (e.g. a white wall)



Reflective surfaces (e.g. shiny car surfaces)



Fast moving objects



Slanted subjects



Dark subjects



Night scenes

## Recording/Playback (Contd.)

**E**

### Problem

### Cause and/or what to do about it

- The ► (play) button doesn't work.
  - The POWER switch is not set to PLAY (p. 18).
  - The cassette is not loaded (p. 9).
  - The tape has reached the end.
  
- There's a bright stripe on the screen.
  - When recording in dark places a bright light in the scene or in the vicinity of the camera may cause a vertical light bar ("smear") to appear. This is a normal feature of camcorders.
  
- The playback picture is rough.
  - The video heads need cleaning (p. 70).
  
- There's no picture on the TV screen, even though the tape is moving.
  - The video heads need cleaning (p. 70).
  - The TV/VIDEO selector on the TV isn't set to VIDEO (p. 22).
  - If connected using the optional RF unit the video channel has not been selected.
  
- There's no sound coming from the speaker during playback.
  - The speaker volume is set to the minimum level (p. 20).
  
- The camera shows FlexiZone, close-up, fader, digital effects and title displays even though it's not being operated.
  - The camera entered the demonstration mode. To cancel it, turn the POWER switch OFF/ON, insert a cassette or set the date and time.
  
- TAPE appears in the display.
  - The camcorder has been moved from a cold place to a warm place so that its temperature changed abruptly. Remove the cassette, set the POWER switch to OFF and wait for an hour before trying to use the camera.
  - The video heads are dirty. Try removing and reloading the tape. If TAPE still shows in the display, use a cleaning tape to clean the heads.

## Miscellaneous

E

### Problem

- The wireless controller doesn't work.
- The camera malfunctions.
  
- The camera doesn't remember the date and time (or other settings) when it's turned off and back on again.
  
- There are air bubbles inside the lens.

### Cause and/or what to do about it

- The batteries are dead or not inserted.
  
- External interference may cause the camera's microprocessor to malfunction temporarily. If random letters appear in the display or if normal operation is interrupted, remove and then replace the power source and the backup battery: camera functions return to their default setting.
  
- You haven't installed the backup battery (p. 67).
- You need to change to a new backup battery because it is dead (p. 67).
  
- This is unlikely, but may happen if you use the camera in places where the air pressure is low, in an airplane for example. The bubbles will disappear a week or so after you return the camera to normal atmospheric pressure.

# The Video System Diagram (Availability differs from area to area)

E

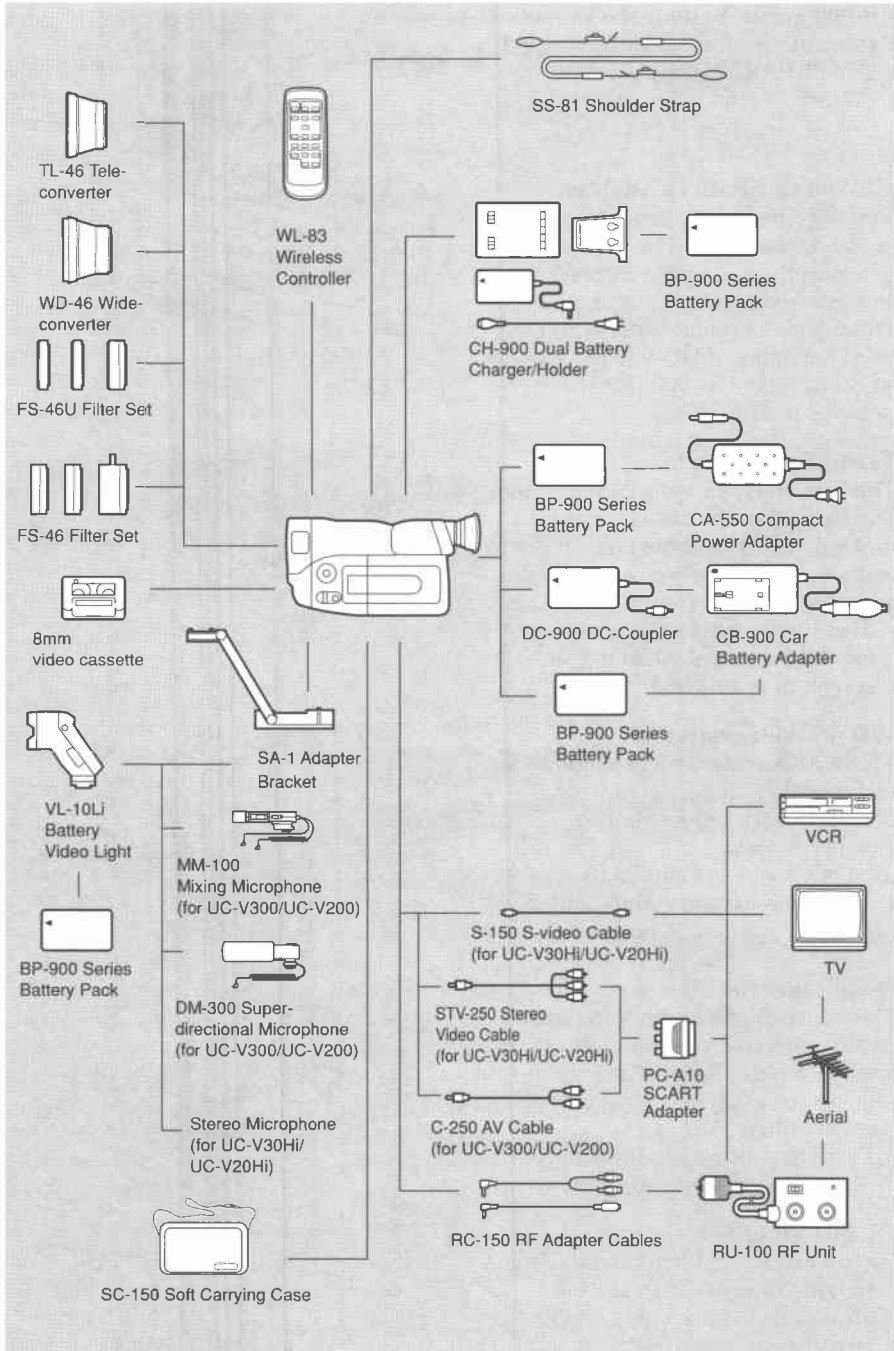

Additional Information

## Optional Accessories

E

### BP-900 Series Battery Packs

Extra batteries for use with the UC-V30Hi/UC-V20Hi/UC-V300/UC-V200.

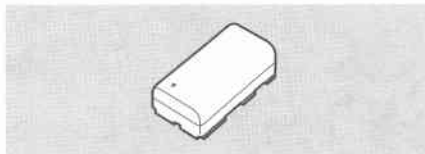

### CB-900 Car Battery Adapter

Power your camera, or recharge battery packs on the move. The car battery adapter plugs into your car's cigarette lighter socket and runs off a 12-24 V DC negative ground battery. You will need the optional DC-900 DC Coupler to connect the CB-900 Car Battery Adapter to camcorder.

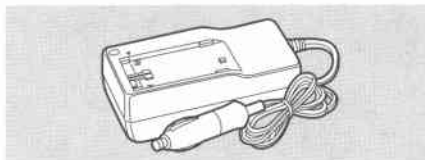

### TL-46 Tele-converter

This tele-converter lens increases the focal length of the camera lens by a factor of 1.4. The zoom and autofocus operate as usual, so you can take full advantage of the extra range.

- The image stabilizer is not as effective as usual when the tele-converter is attached.

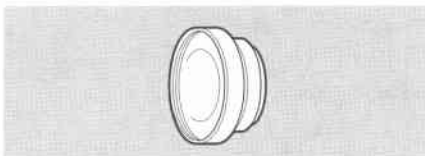

### WD-46 Wide-converter

This lens decreases focal length by a factor of 0.7, giving you a wide perspective for indoor shots or panoramic views - and you can still use both zoom and autofocus.

- There may be some vignetting at the extreme wide angle position.

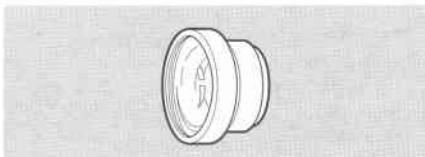

### FS-46 Filter Set

Three special effects filters to add a creative touch to your recordings: multiple-image, R-cross and zoom-spot.

- Focus manually when using special effects filters.
- There may be some vignetting at the extreme wide angle position.

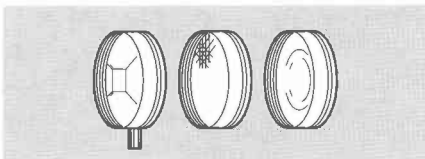

### FS-46U Filter Set

Ultraviolet, neutral density and circular polarizing filters to help you take control of difficult lighting conditions.

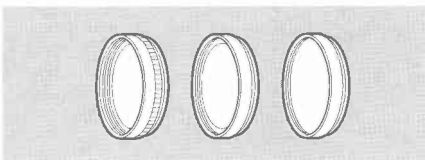

### SC-150 Soft Carrying Case

This lightweight bag keeps the camera within easy reach without weighing you down or getting in the way.



### RU-100 RF Unit

This optional converter allows the camera to be connected to the antenna terminal of any TV. It can be a useful accessory while traveling, as you may need it if you want to connect the camera to a TV in your hotel room.

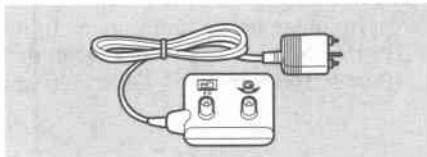

### RC-150 RF Adapter Cables

This makes it possible to use the RU-100 RF Unit with the camera.

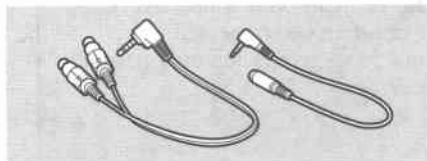

### MM-100 Mixing Microphone (for UC-V300/UC-V200)

The MM-100 mixes live sound and music, so you can create the ideal soundtrack for your video productions.

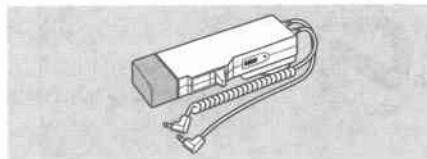

### DM-300 Super-directional Microphone (for UC-V300/UC-V200)

This highly sensitive super-directional microphone helps you obtain quality sound recording even in the most difficult conditions.

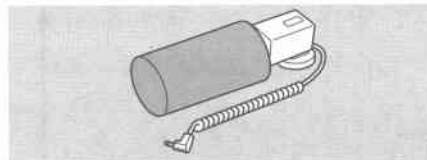

### SA-1 Adapter Bracket

Attaches a video light or microphone securely to the camera.

- Use with the camcorder's LCD panel in the open position.

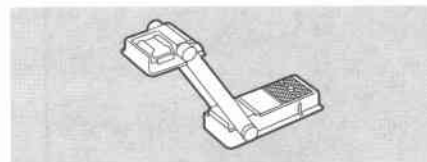

E

**E**

### **VL-10Li Battery Video Light**

This compact yet powerful video light can be used for both indoor and outdoor shooting.



- Lithium ion battery packs are used to power the light.

Approximate usage times are as follows:

BP-915: 60 min. BP-914: 50 min. BP-927: 100 min. BP-930: 120 min.  
BP-941: 160 min. BP-930R: 120 min.

### **CH-900 Dual Battery Charger/ Holder**

This holds two battery packs and can charge them both consecutively. It can then be connected directly to the camera to give twice the operation time.

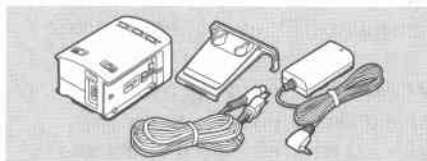

This mark identifies genuine Canon video accessories. When you use Canon video equipment, we recommend Canon-brand accessories or products bearing the same mark.



# Finding Your Way Around the Camcorder

E

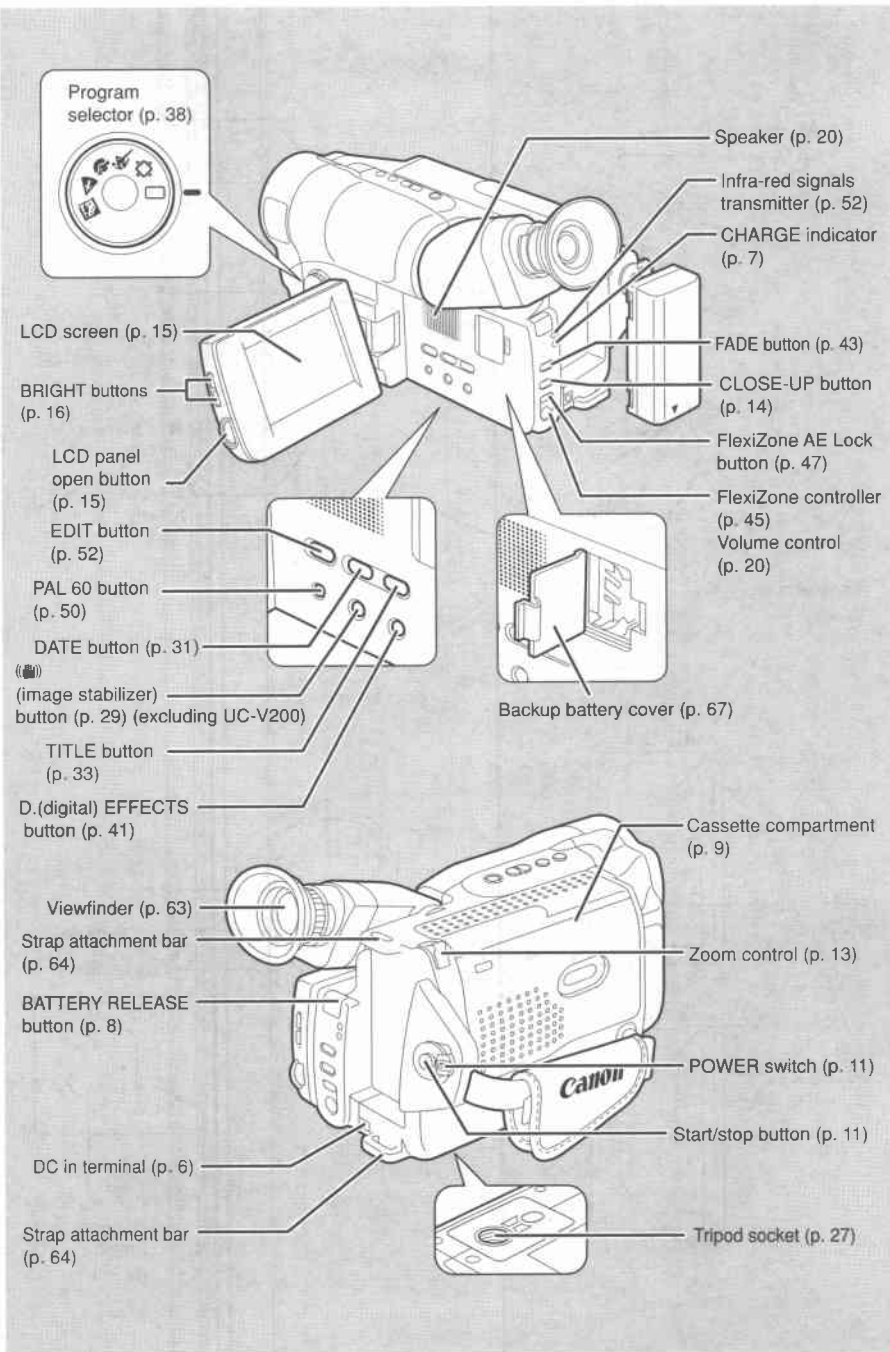

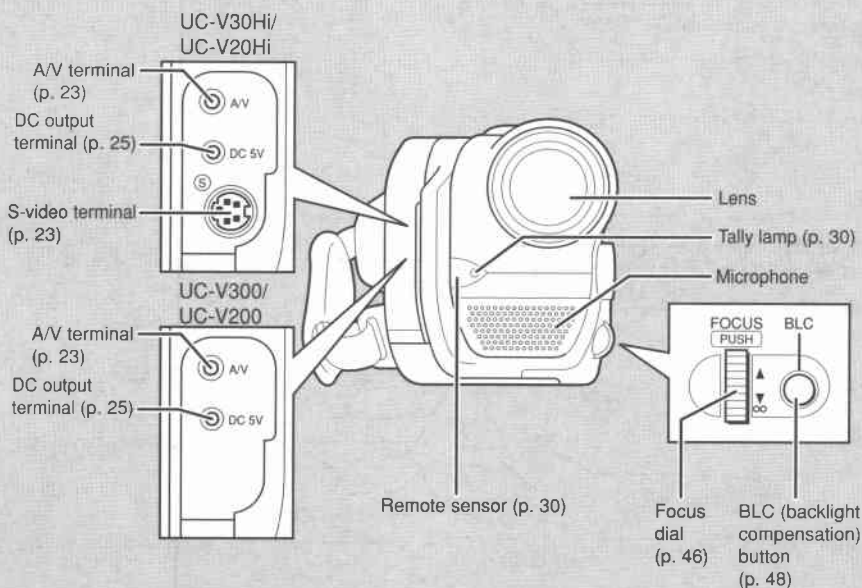
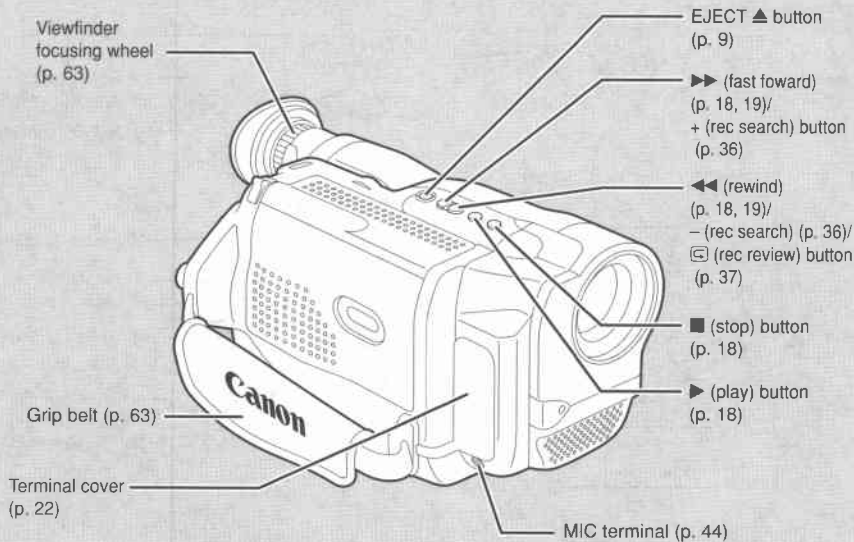

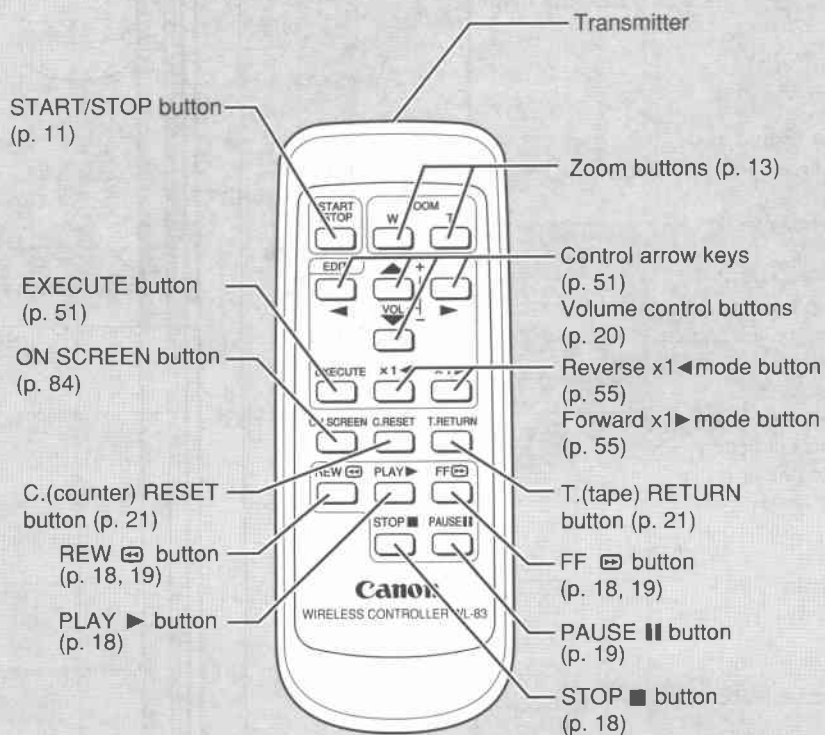

# Screen Displays

E

Use the wireless controller's ON SCREEN button to make the displays on the TV screen/in the camera display appear or disappear. (The displays appear white on-screen.) They will not be added to any recordings you make with the camera.

 indicates a flashing display.

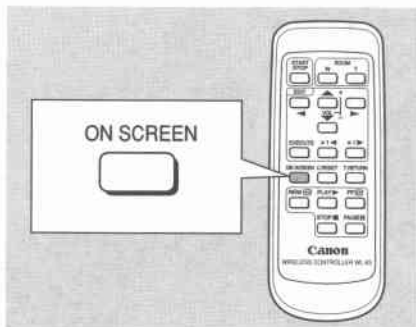

Record pause mode (p. 11)



Recording (p. 11)



Shows how much battery power remains (p. 66).



Shows how many minutes of battery power remain when using the BP-930R battery pack (p. 66)



The battery pack is exhausted (p. 7, 66).



Remaining tape:

Near tape winding start position



Near midway winding position



Near tape winding end position



Up to about 10 seconds after starting recording/playback



Hi 8 Recording or playback (UC-V30Hi/UC-V20Hi).



PAL 60 (p. 50)



The camera is ejecting the tape (p. 9).



Playback is stopped (p. 18).



Normal playback (p. 18)



Still playback (p. 19)



Fast forward (p. 18)



Rewind (p. 18)



Fast forward playback/High-speed search (forward) (p. 19)



Rewind playback/High-speed search (rewind) (p. 19)



Tape return (forward and reverse) (p. 21)

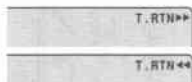

Date Search (p. 49)



Date Search (forward and reverse) (p. 49)

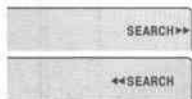

Zoom display (p. 13): Optical zoom



Optical plus digital zoom

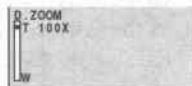

Close-up



Zoom in



Zoom out



The image stabilizer is turned on (p. 29).

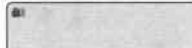

Date and time (p. 31)

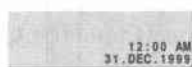

Auto date recording (p. 32)

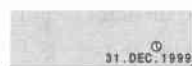

Date only (p. 32)



Titles (p. 33)



Appears when you are writing a title.



Recording programs (p. 38)



Manual focus is selected (p. 46)

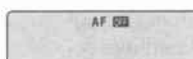

Backlight compensation (p. 48)



The brightness of the LCD screen (p. 16)



The volume of the speaker (p. 20)



Digital effects. The display flashes when the function has been selected and appears steadily when it is turned on (p. 40).



Digital faders (p. 42)



E

**E****Warnings**

**Flashing:** When the amount of tape remaining reaches three minutes or less during recording.



**Lit:** When the tape has run out during recording.



**Flashing:** When the power is turned ON without a tape inserted or a recording-prohibited tape has been inserted.

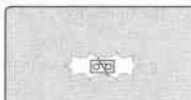

**Flashing:** When condensation or a malfunction occurs (p. 72).



**Flashing:** When the backup battery is almost exhausted or none has been inserted (p. 67).

**Tape counter**

The tape counter indicates the approximate running time of the tape - 1 hour, 23 minutes and 45 seconds in this example. The tape counter is reset when a cassette is loaded, or when you press the wireless controller's C. RESET button.

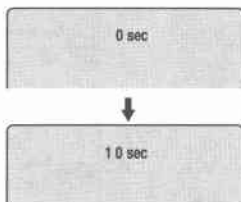
**Recording reminder**

When you start recording, the camera counts from 0SEC to 10SEC. Shots which are shorter than 10 seconds may be difficult to edit later. On the other hand, if you are not planning to edit the recording, remember that a shot which does not contain action should generally last no longer than 10 seconds.

# Specifications

## UC-V30Hi/UC-V20Hi/UC-V300/UC-V200

**Power Supply (rated):** 7.2 V DC

**Power Consumption (while recording with the AF turned on):**  
UC-V30Hi: 4.4 W (LCD screen OFF), 5.0 W (LCD screen ON);  
UC-V20Hi: 4.4 W (LCD screen OFF), 4.9 W (LCD screen ON);  
UC-V300: 4.3 W (LCD screen OFF), 4.8 W (LCD screen ON);  
UC-V200: 4.0 W (LCD screen OFF), 4.5 W (LCD screen ON)

**Television system:**  
CCIR standard (625 lines, 50 fields) PAL colour signal

**Video recording system:** 2 rotary heads, helical scanning system; luminance signal: FM azimuth recording; chrominance signal: converted subcarrier phase shift recording (8mm video standard)

**Audio recording system:** Frequency multiplexing with the video signal (UC-V30Hi/UC-V20Hi: 2 channels; UC-V300/UC-V200: 1 channel)

**Image sensor:** 1/4" CCD (charge coupled device)  
UC-V30Hi/UC-V20Hi: 470,000 pixels (440,000 effective pixels);  
UC-V300/UC-V200: 320,000 pixels (290,000 effective pixels)

**Tape format:** 8mm videocassette,  
UC-V30Hi/UC-V20Hi: metal evaporated/metal particle;  
UC-V300/UC-V200: metal particle

**Tape speed:** 20.05 mm/s

**Fast forward/rewind time:** Approx. 6.5 minutes (with a P5-90 cassette)

**Lens:** UC-V30Hi/UC-V20Hi/  
UC-V300: F/1.6-3.7, 3.9-85.8 mm  
UC-V200: F/1.6-3.8, 4-88 mm  
22x power zoom

**Focusing system:** TTL autofocus, manual focusing possible

**Minimum focusing distance:** Wide-angle end: 1cm (3/8 in); telephoto end: 1m (3 ft 3 in)

**Minimum illumination:**  
UC-V30Hi/UC-V20Hi: 0.6 lx  
UC-V300/UC-V200: 0.4 lx

**Recommended illumination:**  
More than 100 lx

**Viewfinder:** 0.5-inch monochrome CRT

**LCD screen:**  
UC-V30Hi: 3" measured diagonally (7.6 cm), 90,000 pixels (approx.)  
UC-V20Hi/UC-V300/UC-V200: 2.5" measured diagonally (6.4 cm), 62,000 pixels (approx.)

**Microphone:**  
UC-V30Hi/UC-V20Hi: Stereo electret condenser microphone  
UC-V300/UC-V200: non-directional electret condenser microphone

**Output level:**  
Video terminal: 1 Vp-p/75 ohms unbalanced  
S-video terminal (UC-V30Hi/UC-V20Hi): 1 Vp-p (Y signal), 0.3 Vp-p (C signal)  
Audio terminal: -10dBv, less than 2.2 kohms, unbalanced

**Operating temperature range:**  
0-40 °C (32-104 °F)

**Dimensions:** 117 × 114 × 215 mm (4 5/8 × 4 1/2 × 8 1/2 in)

**Weight:** UC-V30Hi/UC-V20Hi/  
UC-V300: 955 g (2 lb 1 5/8 oz)  
UC-V200: 885 g (1 lb 15 1/4 oz)

## BP-915 Battery Pack

**Battery type:** Rechargeable lithium ion battery

**Rated voltage:** 7.2 V DC

**Operating temperature:** 0°-40°C (32°-104°F)

**Battery capacity:** 1,500 mAh

**Dimensions:** 38.2 × 20.5 × 70.5 mm (1 1/2 × 3/4 × 2 3/4 in)

**Weight:** 96 g (3 3/8 oz)

Weight and dimensions are approximate. Errors and omissions excepted. Subject to change without notice.

# Index

## E

### A

Abroad, Using the Camera, 71  
Accessories, 4, 78  
Adapter, AC, 6  
Art, 40  
Art Fade, 42  
Audio Recording, 44  
A/V Terminals, 23  
Autofocus, 45

### B

Backlight Compensation, 48  
Backup Battery, 67  
Basic Recording, 11  
Battery Pack, 7  
Black and White, 43

### C

Cables, 4, 22  
Cassettes, 9  
Charging the Battery Pack, 7  
Cleaning the Camera, 70  
Close-Up, 14  
Condensation, 72  
Connection to TV or VCR, 22  
Counter reset, 21

### D

Date Search, 49  
Date and Time, 31  
Digital Effects, 40  
Digital Faders, 42  
Digital Zoom, 13

### E

Editing, Simple, 62  
Editing Function, 51  
8mm Video, 5  
Exposure, 47  
External Microphone, 44  
Extra Long Digital Zoom, 40

### F

Fast Forward, 19  
Feedback, 24  
Finding Your Way Around  
the Camcorder, 81  
FlexiZone AE, 47  
FlexiZone AF, 45  
Focusing, 45

### G

Grip Belt, 63

### H

Head Cleaning, 70  
High-speed search, 19  
Hi8, 10  
Horizontal Wipe, 42

### I

Image Stabilizer, 29  
Introducing the Camcorder, 5

### L

LCD Screen, 15  
Lens Cap, 63  
Loading Cassettes, 9

### M

Maintenance, 69  
Making Better Videos, 27  
Manual Focus, 46  
Mirror, 40  
MIC, 44  
Mosaic, 40  
Mosaic Fade, 42

### N

Negative-Positive Conversion, 40

### O

On Screen, 84  
Optical Zoom, 13  
Optional Accessories, 78



**P**

PAL 60 TV Playback, 50  
Pause, Record, 11  
Playback, 18  
Playback Connection, 22  
Power Adapter, 6  
Powering Your Camcorder, 6  
Preparing the Camera, 63  
Problems, 73

**R**

Recharging the Battery Pack, 7, 65  
Recording, 11  
Recording Programs, 38  
Record Pause Mode, 11  
Record Review, 37  
Record Search, 36  
Remote Control, 30  
Remote Sensor, 30  
Rewind, 19

**S**

Screen Displays, 84  
Sepia, 41  
Shoulder Strap, 64  
16:9, 40  
Speaker, 20  
Specifications, 87  
Still, 19  
Storage, 69  
S-video, 23  
System Diagram, 77

**T**

Tape Protection, 10  
Tape Return, 21  
Telephoto, 13  
Temperature, 65, 69  
Titles, 33  
Tips for Making Better Videos, 27  
Tripod, 27  
Troubleshooting, 73  
TV, 22

**U**

Using the Camera Abroad, 71

**V**

VCR, 22  
Video cassettes, 9  
Video Channel, 26  
Video heads, 70  
Viewfinder, 63  
Volume, 20

**W**

White Fade, 42  
Wide-angle, 13  
Widescreen TV, 40  
Wireless Controller, 30

**Z**

Zoom Fade, 42  
Zooming, 13

**E**





# Canon

## **CANON INC.**

### **Canon Europa N.V.**

P.O. Box 2262, 1180 EG Amstelveen, the Netherlands

### **Canon UK Ltd**

Camera Division, Units 4 & 5, Brent Trading Centre, North Circular Road, Neasden, London  
NW10 0JF, United Kingdom  
Telephone 081-459-1266

### **Canon Australia Pty. Ltd**

1 Thomas Holt Drive, North Ryde, N.S.W. 2113, Australia  
Telephone 805-2000, Fax 887-4484

### **Canon New Zealand Ltd**

Fred Thomas Drive, Takapuna, P.O. Box 33-336, Auckland, New Zealand  
Telephone 486-1570, Fax 486-6420

### **Canon Singapore Pte. Ltd**

79 Anson Road #09-01/06, Singapore 079906  
Telephone (65)-532-4400, Fax (65)-221-2939

### **Canon Hongkong Co., Ltd**

10/F, Mirror Tower, 61 Mody Road, Tsimshatsui East, Kowloon, Hong Kong

### **Canon Latin America, Inc.**

Sales & Enquiries: 6505 Blue Lagoon Drive Suite 325 Miami FL 33126 USA