

DIGITAL VIDEO CAMCORDER

# Instruction Manual

ENGLISH

E

CAMESCOPE ET LECTEUR VIDEO NUMERIQUES

# Mode d'emploi

FRANÇAIS

F

VIDEOCAMARA Y GRABADORA DIGITAL

# Manual de Instrucciones

ESPAÑOL

Es

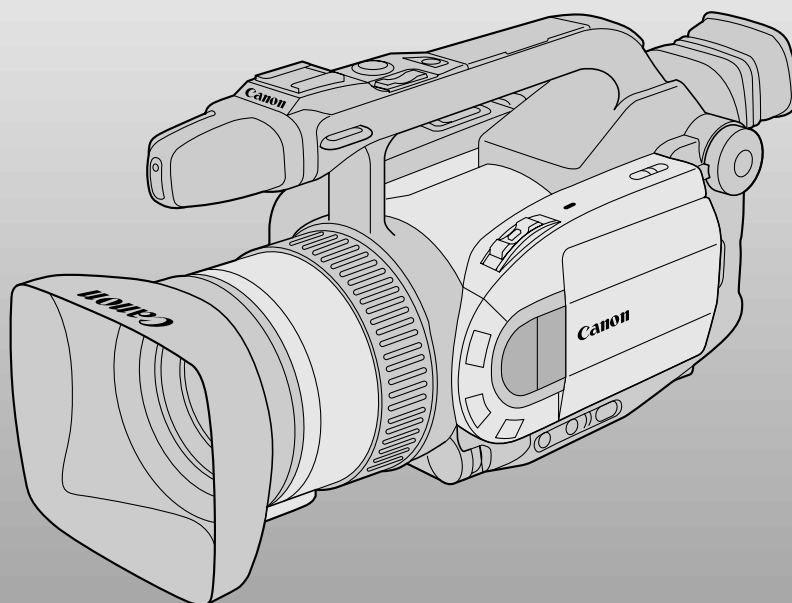

# Canon

# GL1

NTSC

Mini DV Digital  
Video  
Cassette

# Important Usage Instructions

E

**WARNING:**



**TO REDUCE THE RISK OF FIRE OR ELECTRIC SHOCK, DO NOT EXPOSE THIS PRODUCT TO RAIN OR MOISTURE.**

**WARNING:**



**TO REDUCE THE RISK OF ELECTRIC SHOCK AND TO REDUCE ANNOYING INTERFERENCE, USE THE RECOMMENDED ACCESSORIES ONLY.**

**COPYRIGHT WARNING:**

**Unauthorized recording of copyrighted materials may infringe on the rights of copyright owners and be contrary to copyright laws.**

Digital Video Camcorder, DM-GL1 and Compact Power Adapter, CA-910A

This device complies with Part 15 of the FCC Rules. Operation is subject to the following two conditions: (1) This device may not cause harmful interference, and (2) this device must accept any interference received, including interference that may cause undesired operation.

Note: This equipment has been tested and found to comply with the limits for class B digital device, pursuant to Part 15 of the FCC Rules. These limits are designed to provide reasonable protection against harmful interference in a residential installation. This equipment generates, uses and can radiate radio frequency energy and, if not installed and use in accordance with the instructions, may cause harmful interference to radio communications. However, there is no guarantee that interference will not occur in a particular installation. If this equipment does cause harmful interference to radio or television reception, which can be determined by turning the equipment off and on, the user is encouraged to try to correct the interference by one or more of the following measures:

- Reorient or relocate the receiving antenna.
- Increase the separation between the equipment and receiver.
- Connect the equipment into an outlet on a circuit different from that to which the receiver is connected.
- Consult the dealer or an experienced radio/TV technician for help.

Use of shielded cable is required to comply with class B limits in Subpart B of Part 15 of FCC Rules.

Do not make any changes or modifications to the equipment unless otherwise specified in the manual.

If such changes or modifications should be made, you could be required to stop operation of the equipment.

Canon U.S.A. Inc.

One Canon Plaza, Lake Success, NY 11042, U.S.A.

Tel No. (516)328-5600

**CAUTION:**

**TO PREVENT ELECTRIC SHOCK, MATCH WIDE BLADE OF PLUG TO WIDE SLOT, FULLY INSERT.**

Introduction

## Important Warning



The lightning flash with arrowhead symbol, within an equilateral triangle, is intended to alert the user to the presence of uninsulated "dangerous voltage" within the product's enclosure, that may be of sufficient magnitude to constitute a risk of electric shock to persons.

**CAUTION:**

**TO REDUCE THE RISK OF ELECTRIC SHOCK, DO NOT REMOVE COVER (OR BACK). NO USER SERVICEABLE PARTS INSIDE. REFER SERVICING TO QUALIFIED SERVICE PERSONNEL.**



The exclamation point, within an equilateral triangle, is intended to alert the user to the presence of important operating and maintenance (servicing) instructions in the literature accompanying the product.

# IMPORTANT SAFETY INSTRUCTIONS

In these safety instructions the word “product” refers to the Canon Digital Video Camcorder DM-GL1A and all its accessories.

1. Read Instructions — All the safety and operating instructions should be read before the product is operated.
2. Retain Instructions — The safety and operating instructions should be retained for future reference.
3. Heed Warnings — All warnings on the product and in the operating instructions should be adhered to.
4. Follow Instructions — All operating and maintenance instructions should be followed.
5. Cleaning — Unplug this product from the wall outlet before cleaning. Do not use liquid or aerosol cleaners. The product should be cleaned only as recommended in this manual.
6. Accessories — Do not use accessories not recommended in this manual as they may be hazardous.
7. Avoid magnetic or electric fields — Do not use the camera close to TV transmitters, portable communication devices or other sources of electric or magnetic radiation. They may cause picture interference, or permanently damage the camera.
8. Water and Moisture — Hazard of electric shock — Do not use this product near water or in rainy/moist situations.
9. Placing or Moving — Do not place on an unstable cart, stand, tripod, bracket or table. The product may fall, causing serious injury to a child or adult, and serious damage to the product. A product and cart combination should be moved with care. Quick stops, excessive force, and uneven surfaces may cause the product and cart combination to overturn.



10. Power Sources — The CA-910A Compact Power Adapter should be operated only from the type of power source indicated on the marking label. If you are not sure of the type of power supply to your home, consult your product dealer or local power company. Regarding other power sources such as battery power, refer to instructions in this manual.
11. Polarization — The CA-910A Compact Power Adapter is equipped with a polarized 2-prong plug (a plug having one blade wider than the other). The 2-prong polarized plug will fit into the power outlet only one way. This is a safety feature. If you are unable to insert the plug fully into the outlet, try reversing the plug. If the plug still fails to fit, contact your electrician to replace your obsolete outlet. Do not defeat the safety purpose of the polarized plug.

12. Power Cord Protection — Power cords should be routed so that they are not likely to be walked on or pinched by items placed upon or against them. Pay particular attention to plugs and the point from which the cords exit the product.
13. Outdoor Antenna Grounding — If an outside antenna is connected to the product, be sure the antenna is grounded so as to provide some protection against voltage surges and built-up static charges. Section 810 of the National Electrical Code, ANSI/NFPA No. 70—1984, provides information with respect to proper grounding of the mast and supporting structure, grounding of the lead-in wire to an antenna discharge unit, size of grounding conductors, location of antenna discharge unit, connection to grounding electrodes, and requirements for the grounding electrode. See figure 1.

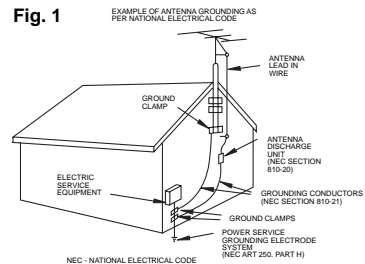

14. Lightning — For added protection of this product during a lightning storm, or when it is left unattended and unused for long periods of time, disconnect it from the wall outlet and disconnect the antenna. This will prevent damage to the product due to lightning and power-line surges.
15. Power Lines — An outside antenna system should not be located in the vicinity of overhead power lines or other electric light or power circuits, or where it can fall into such power lines or circuits. When installing an outside antenna system, extreme care should be taken to keep from touching such power lines or circuits as contact with them might be fatal.
16. Overloading — Do not overload wall outlets and extension cords as this can result in a risk of fire or electric shock.
17. Objects and Liquid Entry — Never push objects of any kind into this product through openings as they may touch dangerous voltage points or short out parts that could result in a fire or electric shock. Be careful not to spill liquid of any kind onto the product.
18. Servicing — Do not attempt to service this product yourself as opening or removing covers may expose you to dangerous voltage or other hazards. Refer all servicing to qualified service personnel.

19. **Damage Requiring Service** — Disconnect this product from the wall outlet and all power sources including battery, and refer servicing to qualified service personnel under the following conditions:
  - a. When the power-supply cord or plug is damaged.
  - b. If any liquid has been spilled onto, or objects have fallen into, the product.
  - c. If the product has been exposed to rain or water.
  - d. If the product does not operate normally even if you follow the operating instructions. Adjust only those controls that are covered by the operation instructions. Improper adjustment of other controls may result in damage and will often require extensive work by a qualified technician to restore the product to its normal operation.
  - e. If the product has been dropped or the cabinet has been damaged.
  - f. When the product exhibits a distinct change in performance. This indicates a need for service.
20. **Replacement Parts** — When replacement parts are required, be sure the service technician has used replacement parts that are specified by Canon or that have the same characteristics as the original part. Unauthorized substitutions may result in fire, electric shock or other hazards.
21. **Safety Check** — Upon completion of any service or repairs to this product, ask the service technician to perform safety checks to determine that the product is in safe operating order.

"Note to CATV system installer: This reminder is provided to call the CATV system installer's attention to Article 820-40 of the NEC that provides guidelines for proper grounding and, in particular, specifies that the cable ground shall be connected to the grounding system of the building, as close to the point of cable entry as practical".

# Contents

## Introduction

Important Usage Instructions .....	2
IMPORTANT SAFETY INSTRUCTIONS .....	3
Thank you for Choosing a Canon .....	6

## Quick Overview

Introducing the GL1 .....	7
Finding Your Way Around the GL1 .....	8
The GL1 System Diagram .....	12
Optional Accessories .....	13
Attaching the Lens Hood .....	15
Powering the GL1 .....	16
Loading a Cassette .....	19
Basic Recording .....	21
Zooming .....	24
Using the LCD Screen .....	25
Playing Back a Cassette .....	28
Connections for Playback on a TV Screen .....	30
Tips for Making Better Videos .....	31

## Using the Full Range of Features

### ~ General ... ~

Turning the Optical Image Stabilizer Off .....	33
Selecting from the Menus .....	34
Using the Wireless Controller/Tally Lamp .....	36

### ~ For Recording ...~

Setting the Date and Time.....	39
Using the ND Filter.....	42
Taking Still Pictures (Photo Mode).....	43
Using a Canon Speedlite for Flash Photography (optional) .....	45
Choosing the Movie Mode (Normal/Frame) .....	46
Searching and Reviewing While Recording .....	47
Using the Various Recording Programs .....	48
Using Digital Effects.....	51
Audio Recording .....	53
Setting the Self-Timer .....	54

### ~ When Making Manual Adjustments ...~

Manual Exposure Adjustment .....	55
Adjusting the Focus .....	58
Using AE Shift .....	59
Adjusting Camera Sharpness .....	60
Adjusting Color Phase .....	61
Using the Zebra Pattern.....	62
Adjusting the White Balance .....	63

### ~ For Playback ...~

Displaying Data Code .....	65
Searching the Tape (Photo Search/ Date Search) .....	67
Returning to a Pre-Marked Position .....	68

## Editing

The Dubbing Function .....	69
Using the Dubbing Function for the First Time .....	70
Cut-In and Cut-Out Adjustments .....	73
Simple Editing to a VCR .....	74
Dubbing with Digital Video Equipment .....	75
Recording from a VCR, TV or Other Camcorder (Analog Line-in) .....	76
Recording Over Existing Scenes (A/V Insert Editing) .....	78
Audio Dubbing .....	80

## Additional Information

Preparing the Camera .....	82
Notes on Using the Batteries.....	83
Setting the Audio Mix .....	86
Camera Holding Styles .....	88
Maintenance .....	89
Troubleshooting.....	92
Screen Displays .....	95
Specifications .....	99
Index .....	100

The serial number of this product may be found on the bottom of the camera. No others have the same serial number as yours. You should record the number and other vital information here and retain this book as a permanent record of your purchase to aid identification in case of theft.

Date of Purchase  
Dealer Purchased From  
Dealer Address  
Dealer Phone No.  
Model Name GL1  
Serial No.

# Thank you for Choosing a Canon

E

First, we'd like to thank you for purchasing this Canon camcorder. Its advanced technology makes it very easy to use — you will soon be making high-quality videos which will give you pleasure for years to come.

To get the most out of your new camcorder, we recommend that you read this manual thoroughly — there are many sophisticated features which will add to your recording enjoyment.

## Getting started





To get started we suggest that you master the basic operations of the camcorder first, before moving on to use its full range of features.

For quick reference (in addition to the contents and index) please refer to:

- Finding Your Way Around the GL1 (p. 8)
- Screen Displays (p. 95)
- Troubleshooting — in case you run into any problems (p. 92)

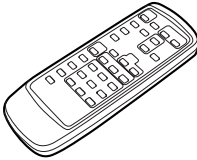
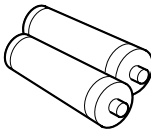
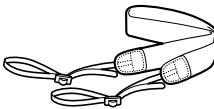
Note that capital letters are used to refer to settings displayed in the menus and buttons labeled on the camcorder itself e.g. Press the MENU button. The camera's short operation confirmation beeps are indicated by ♪ in the illustrations. Beeps sound to confirm your operations, e.g. Turn the standby lever to STANDBY (p. 21).

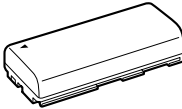
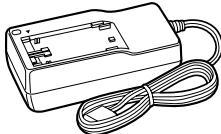
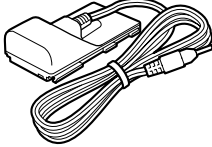
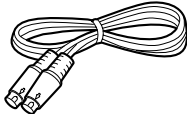
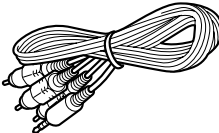
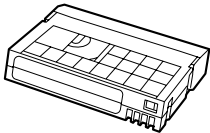
Your camcorder is supplied with the following accessories:

WL-D73 Wireless Controller 	Two AA batteries 
SS-650 Shoulder Strap 	Lens cap (Attached to camera) 
BP-915 Battery Pack 	CA-910 Compact Power Adapter 
DC-905 DC Coupler 	S-150 S-video Cable 
STV-250N Stereo Video Cable 	DVM-E30 Digital Video Cassette 
Lens hood 	

# Introducing the GL1

## Digital Video

GL1 conforms to the new digital video <sup>Mini</sup>**DV** standard to give you outstanding picture quality. It is fitted with a DV terminal for digital-to-digital dubbing (IEEE 1394 standard).

## L Series Fluorite 20× (100× Digital) Zoom Lens

From wide-angle to 20× telephoto — with unparalleled optical quality. The digital zoom magnifies this by five times for even more dramatic results. Fluorite incorporated into the lens produces images with high-contrast, true-to-life color.

## 3 CCD System with Pixel Shift Technology

Superb picture quality results from using a larger light capturing area for each pixel (and fewer pixels) to give higher sensitivity, higher SN ratio and a greater dynamic range, and then horizontally shifting the green CCD to ensure high image resolution. In addition, you can get stunningly clear still pictures from video action.

## Frame Movie Mode

During playback, pause the video any time you like to view a crystal clear still image in the display or on a connected TV screen. It is also possible to transfer your favorite still pictures to a PC for image enhancement and printout.

## 2.5" LCD Screen



An LCD screen makes it easy for you to shoot colorful, well composed video. It is also great for playback.

## Optical Image Stabilizer



Canon's optical technology stabilizes your recordings even in long telephoto shots.

## Manual Control

Choose to operate the GL1 using the Manual recording program to access the complete set of manual functions, for exceptional creative freedom.

## Dubbing Function

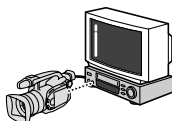

The GL1's dubbing function directly controls your VCR, allowing you to dub at the touch of a button.

## Audio Dubbing/AV Insert Editing



Add new sound to original sound, or replace original sound and images on a prerecorded tape.

## Analog Line-in Recording

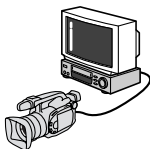

Connect to a VCR or analog camcorder and record onto a DV tape in the GL1.

## DV terminal (IEEE 1394)

GL1 is equipped with a DV terminal that conforms to IEEE 1394. By connecting the GL1 to your computer, you can capture still or motion images on your computer (commercially available IEEE 1394 computer interface board required).

## PCM Digital Sound

Offers you stunning digital sound — 16-bit for highest quality sound, and 12-bit for audio dubbing.

## Digital Effects



Advanced digital technology allows you to add special effects to your videos.

# Finding Your Way Around the GL1

E

Quick Overview

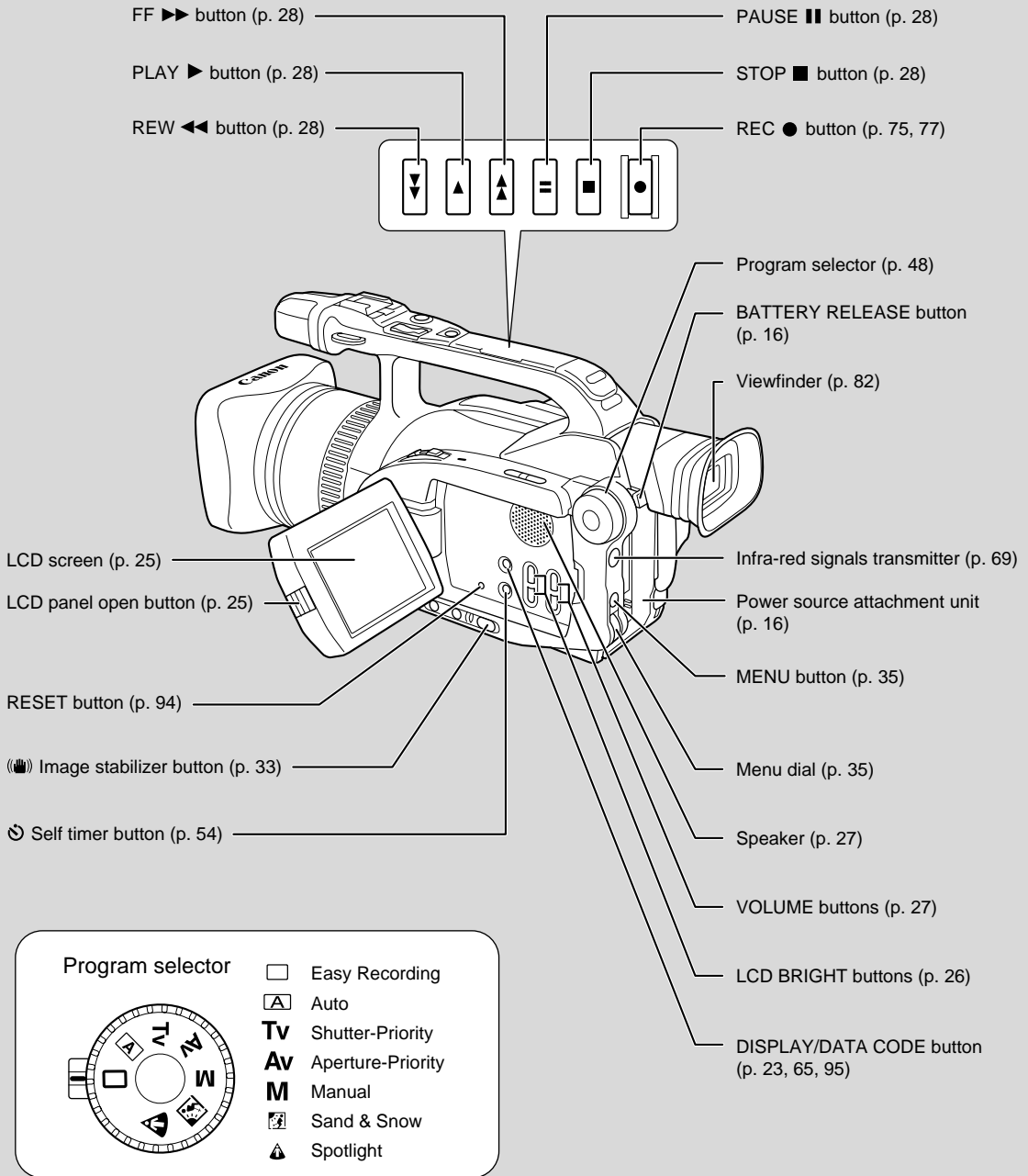



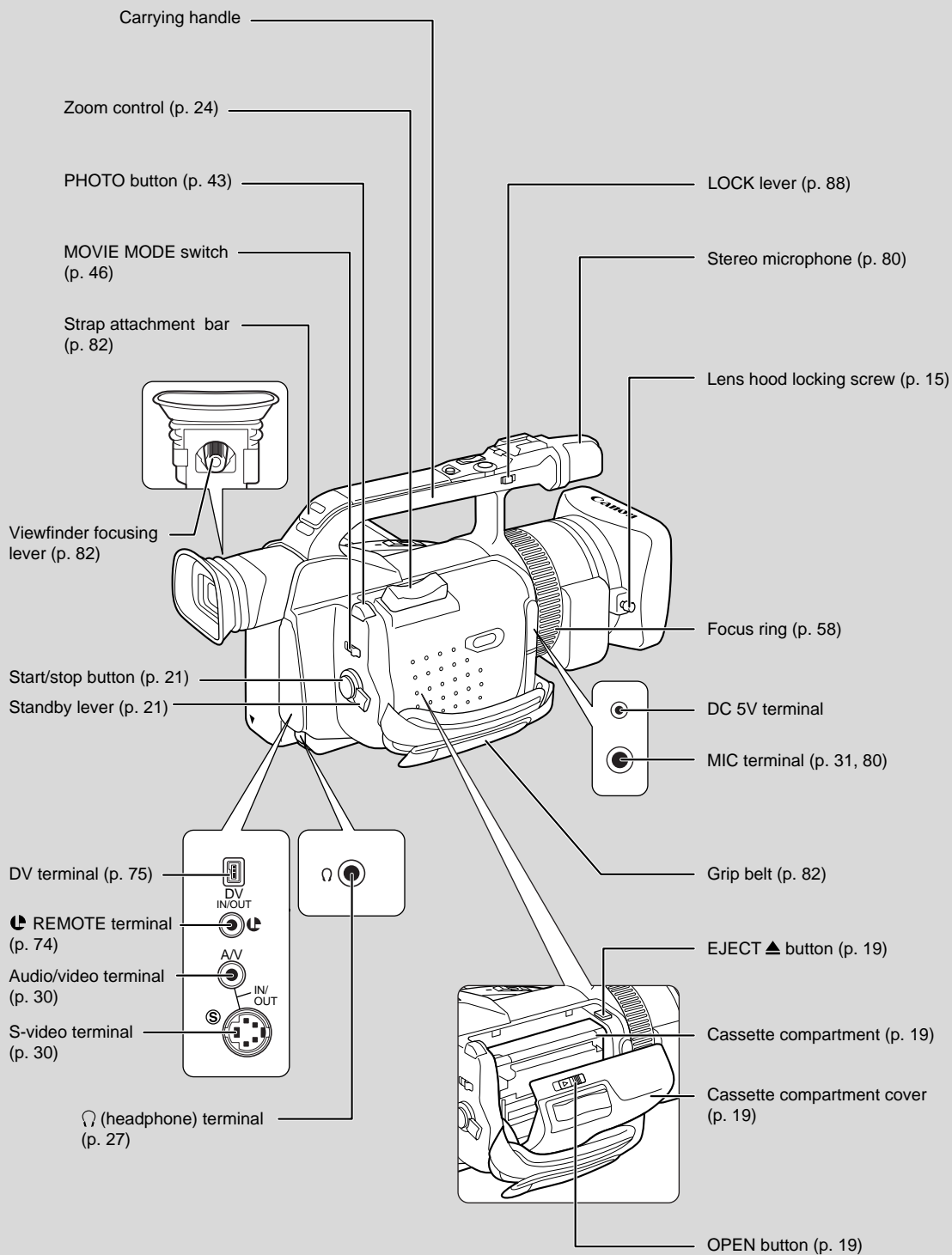

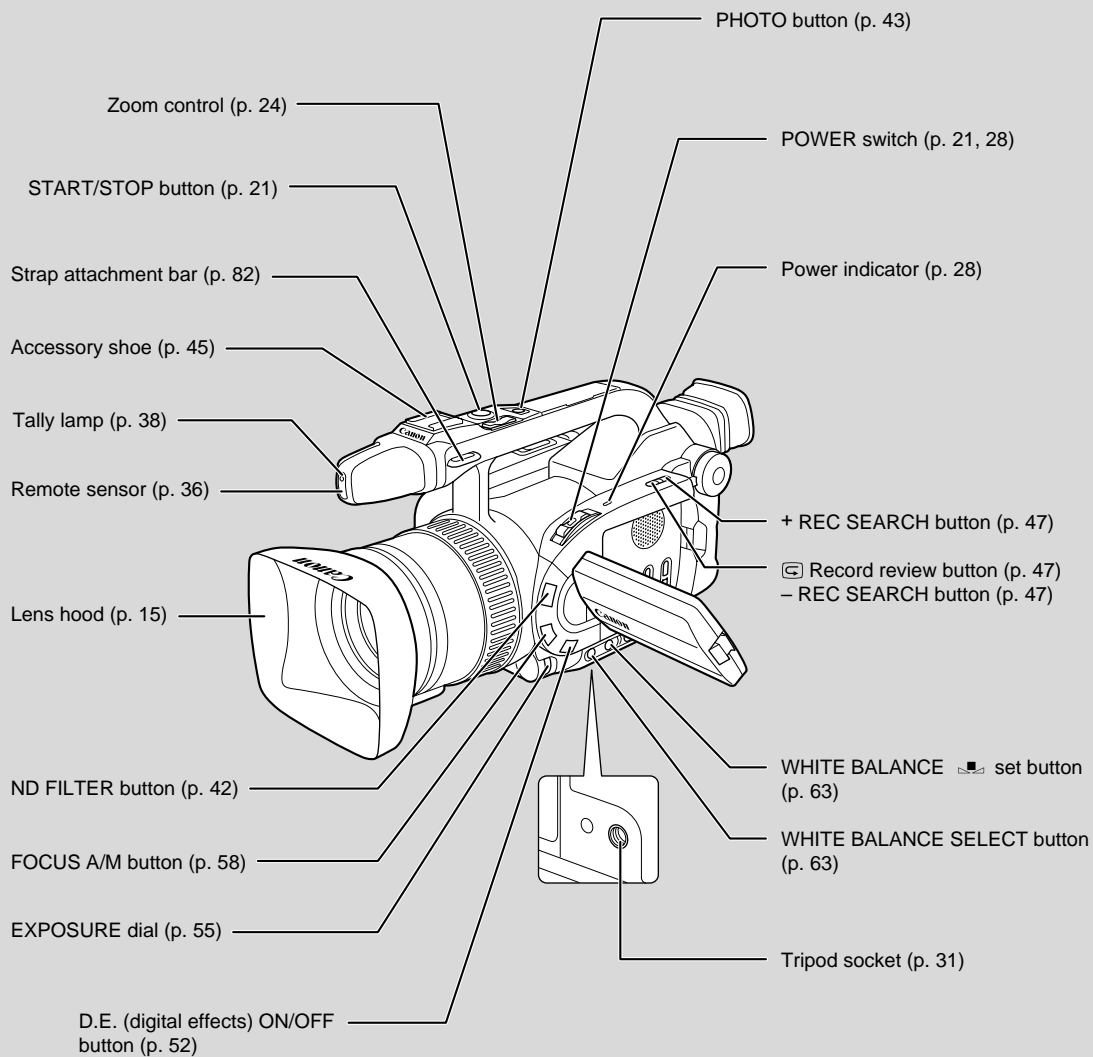

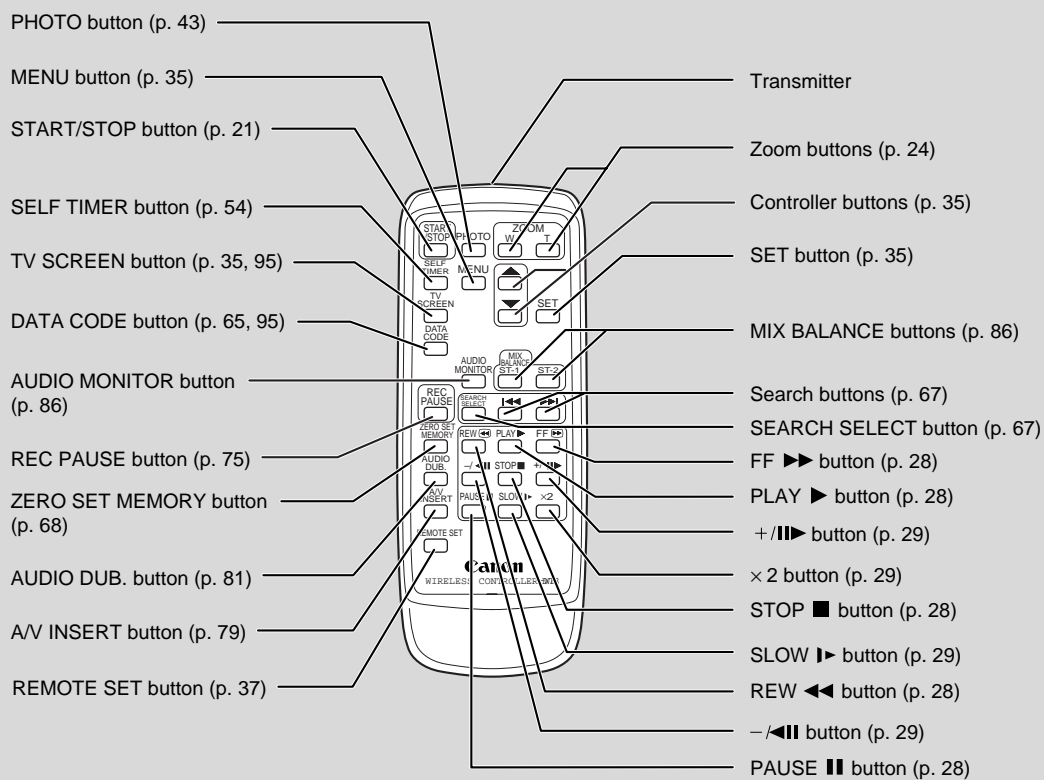

# The GL1 System Diagram (Availability differs from area to area)

E

Quick Overview

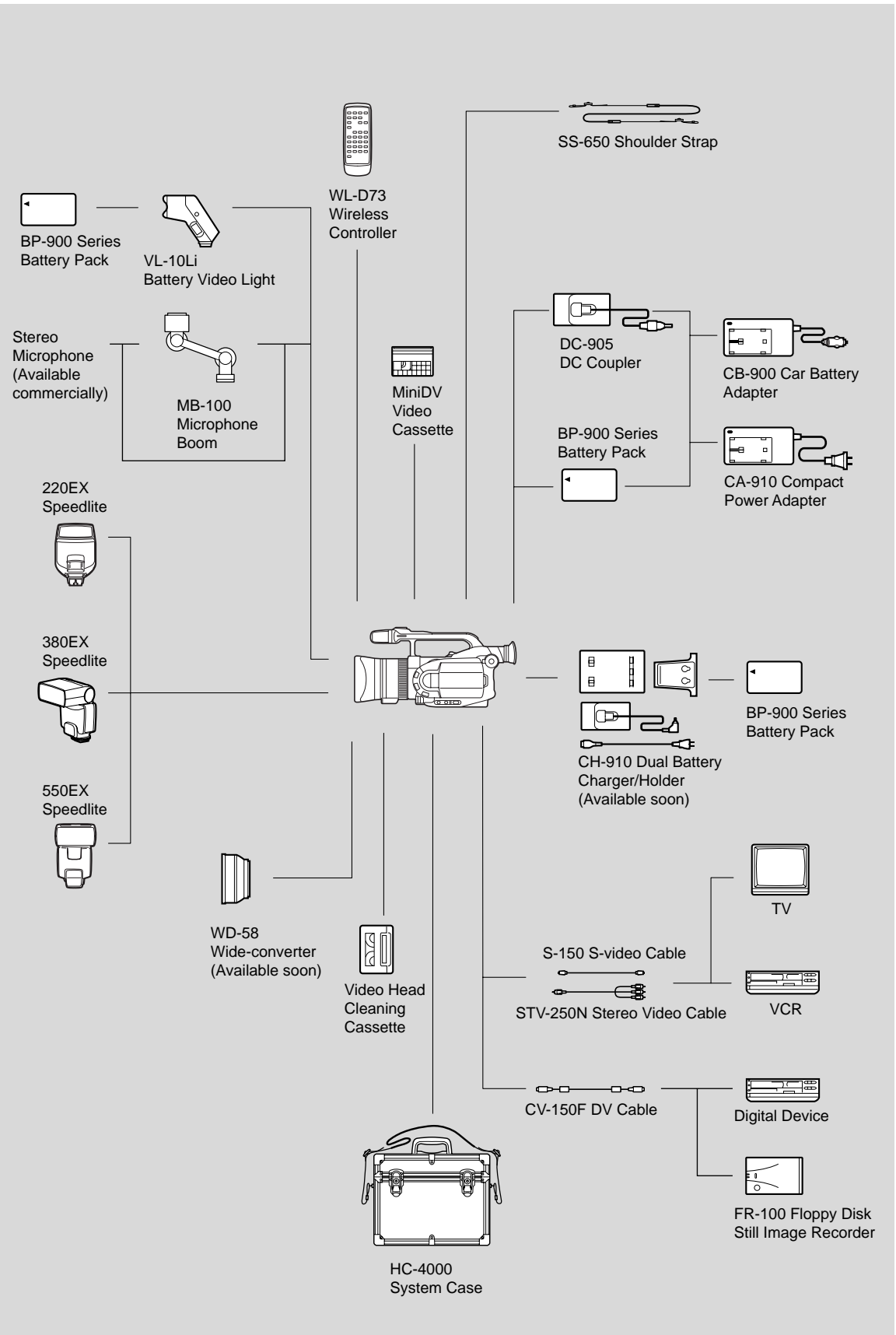

## Optional Accessories

Call or visit your local retailer/dealer for genuine Canon video accessories. You can also obtain genuine accessories for your Canon camcorder by calling 1-800-828-4040, Canon U.S.A. Information Center.

E

### Battery Packs

Extra batteries for use with the GL1.

When you use the optional BP-930R (without the CH-910 Dual Battery Charger/Holder), the remaining time indicator appears, showing you how many minutes you can continue to record before the battery is exhausted (see p. 83).

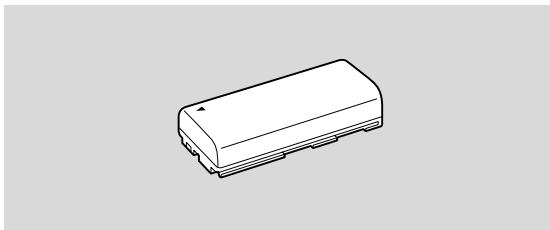

Battery pack	Maximum recording		Time required for full charge
	using viewfinder	using LCD screen	
BP-914 (optional)	1 hr.	55 min.	2 hrs. 10 min.
BP-915 (supplied)	1 hr. 5 min.	1 hr.	2 hrs. 10 min.
BP-930 (optional)	2 hrs. 15 min.	2 hrs. 10 min.	3 hrs. 30 min.
BP-930R (optional)	2 hrs. 10 min.	2 hrs. 5 min.	3 hrs. 20 min.
BP-941 (optional)	3 hrs. 5 min.	2 hrs. 55 min.	4 hrs. 10 min.

When you attach two battery packs to the CH-910 Dual Battery Charger/Holder, the maximum recording time will be almost doubled.

Battery pack	Playback time (using the LCD screen)
BP-914	1 hr. 25 min.
BP-915	1 hr. 35 min.
BP-930	3 hrs. 10 min.
BP-930R	2 hrs. 55 min.
BP-941	4 hrs. 15 min.

These figures show how long you can view playback with the LCD, after attaching a fully-charged battery pack. Playback time will be shortened at low temperatures.

### CB-900 Car Battery Adapter

Power your camera, or recharge battery packs on the move. The car battery adapter plugs into your car's cigarette lighter socket and runs off a 12–24 V DC negative ground battery.

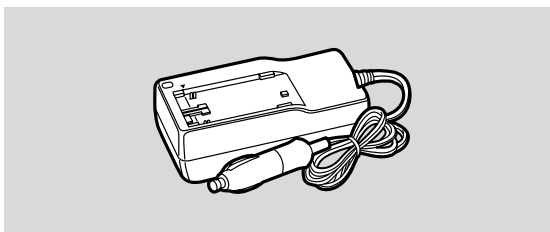

### WD-58 Wide-converter

This lens decreases focal length by a factor of 0.7, giving you a wide perspective for indoor shots or panoramic views.

- There may be some vignetting at the extreme wide angle position.

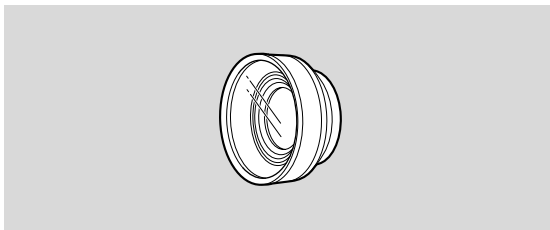

### FR-100 Floppy Disk Still Image Recorder

Connects to the GL1 or any Canon camcorder with a DV terminal and records still images onto a floppy disk in one of three resolution choices. Images from the disk can then be transferred to a computer. Available: Winter 1999

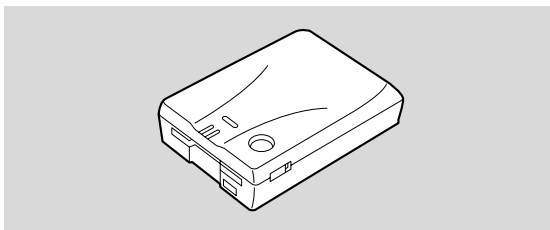

**HC-4000 System Case**

A solid, lockable case that provides safe and stylish protection for the camera during transportation and storage.

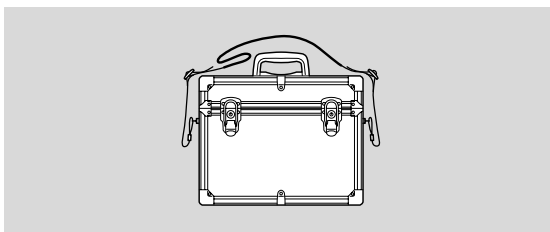
**VL-10Li Battery Video Light**

This compact yet powerful video light can be used for both indoor and outdoor shooting.

- Lithium ion battery packs can be used to power the light. Approximate usage times are as follows:
 

BP-914	50 min.	BP-915	1 hr.
BP-941	2 hrs. 40 min.	BP-930	2 hrs.
BP-930R	2 hrs.		

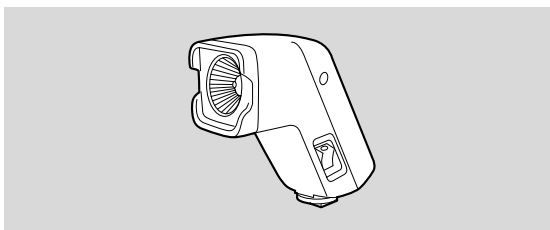
**CH-910 Dual Battery Charger/ Holder**

This holds two battery packs and can charge them both consecutively.

It can then be connected directly to the GL1 to give twice the playback time. It can also make use of the high performance battery pack BP-941, to give up to 6 hrs. recording time.

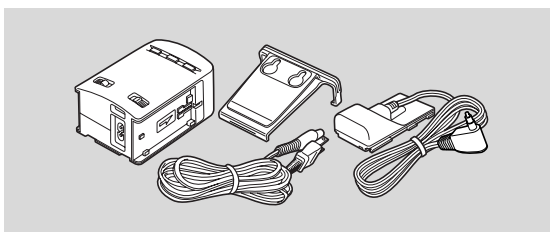
**220EX Speedlite****380EX Speedlite****550EX Speedlite**

Attach to the GL1 to give SLR-style flash photography.

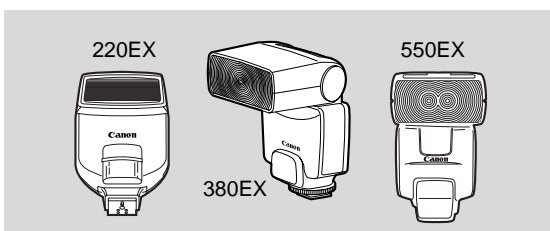

This mark identifies genuine Canon video accessories. When you use Canon video equipment, we recommend Canon-brand accessories or products bearing the same mark.

**Provided accessories:**

WL-D73 Wireless Controller	D83-0532-000
CA-910 Compact Power Adapter	D85-1022-201
DC-905 DC Coupler	D85-1170-201
BP-915 Battery Pack	D85-0952-201
SS-650 Shoulder Strap	D81-1350-000
S-150 S-video Cable	D82-0330-202
STV-250N Stereo Video Cable	D82-0590-201
Lens Hood	D52-0110-000
Lens Cap	DG1-3740-000

**Optional accessories:**

FR-100 Floppy Disk Still Image Recorder	D89-0732-002
CB-900 Car Battery Adapter	D85-0502-201
CH-910 Dual Battery Charger/ Holder	D85-1072-002
HC-4000 System Case	D81-1360-000
VL-10Li Battery Video Light	D86-0081-201
MB-100 Microphone Boom	D89-0200-202
JR7.2V 10WF Halogen Bulb	DY4-4530-000
220EX Speedlite (Flash Unit)	C50-0741-201
380EX Speedlite (Flash Unit)	C50-0721-201
550EX Speedlite (Flash Unit)	C50-0731-011
DVM-CL DV Cleaning Cassette	D36-0032-201

## Attaching the Lens Hood

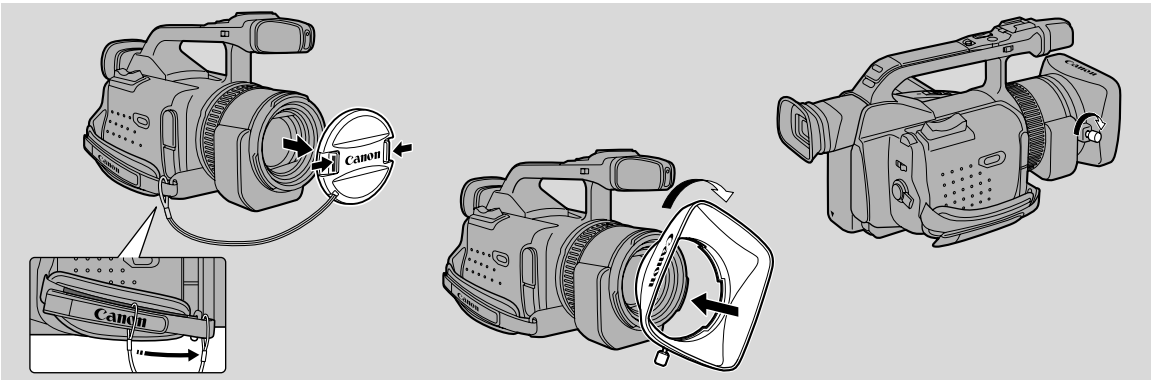

E

### 1. Remove the lens cap.

- When you purchase the GL1, the lens cap cord is attached in the middle of the velcro grip belt. Open the velcro and slide the lens cap cord to the position shown in the illustration.

### 2. Align the hood to the lens with the Canon logo facing to the left.

### 3. Twist it into position (clockwise), so that the Canon logo is to the top.

- You do not need to assert any pressure — screw the hood lightly into place.

### 4. Finally, tighten the locking screw.

- To remove, reverse the above procedure.

Since the lens hood cuts stray light that may cause flare and ghost images and protects the lens, be sure to attach the hood when you are recording.

## Powering the GL1

Before operating your camera, you will need to use the power adapter to:

E

provide power from an AC outlet

or

charge a battery pack

### Notes:

- The power adapter converts current from a household power socket (100–240 V AC, 50–60 Hz) to the DC current used by your camera.
- If the adapter is used next to a TV, it may cause the TV to emit noise — move the adapter away from the TV or the antenna cable.

### Connecting the camera to an AC outlet

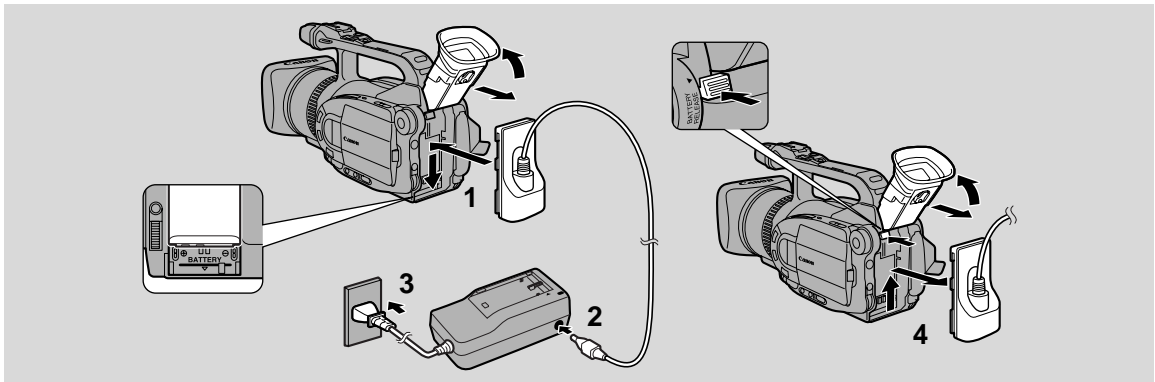

Use the power adapter and the DC coupler to provide your camera with instant power from an AC outlet.

#### 1. Attach the DC coupler to the camera.

- Extend the viewfinder and rotate it upwards.
- Align the edge of the DC coupler with the line on the camera.
- Slide the coupler down in the direction of the arrow, until it clicks into place.

#### 2. Connect the DC coupler to the adapter.

#### 3. Plug the adapter into an AC outlet.

#### 4. Detach the DC coupler after use.

- Press and hold the BATTERY RELEASE button, while you slide the coupler up.
- Always turn the camera off and raise the viewfinder before removing the power source.



## Charging and attaching the battery pack

E

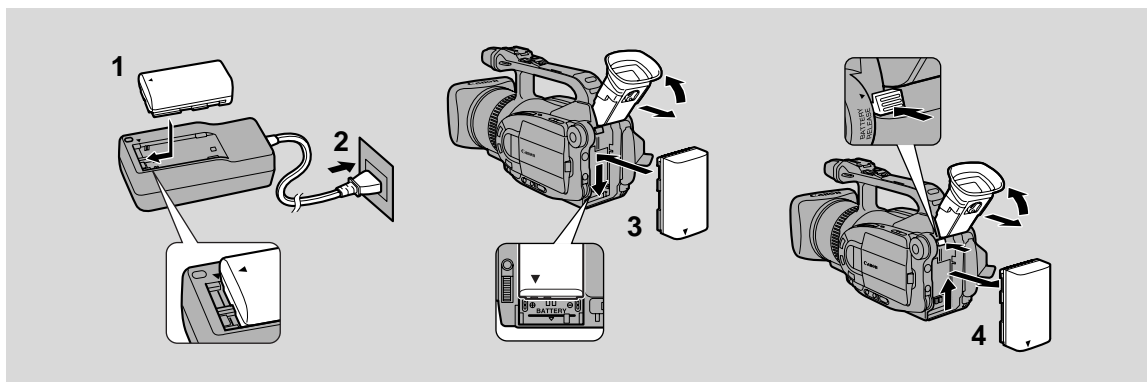

Your battery pack was partially charged before it left the factory. It should have enough power for you to check that your camera is working properly. However, you must charge the battery pack fully if you want it to power the camera for more than a few minutes.

### 1. Attach the battery pack to the power adapter.

- Make sure the DC coupler is not connected.
- Align the triangle on the battery pack with the line on the power adapter.
- Slide the battery across until it clicks into place.

### 2. Plug the adapter into an AC outlet.

- The charge indicator flashes red to show that charging is in progress. Single flashes mean that the battery pack is less than 50% charged. Double flashes mean that it is between 50% and 75% charged. Triple flashes mean that it is more than 75% charged.
- The indicator glows steadily when the battery pack is fully charged.

### 3. Take the battery pack off the adapter and attach it to the camera.

- Extend the viewfinder and rotate it upwards.
- Align the triangle on the battery pack with the line on the camcorder, then slide the battery in the direction of the arrow until it clicks into place.

### 4. Remove the battery pack after use.

- Press and hold the BATTERY RELEASE button, while you slide the battery up.
- Always turn the camera off and raise the viewfinder before removing the power source.

#### Notes:

- You can find detailed notes for using the batteries in the “Notes on Using the Batteries” on p. 83. These notes include charging and recording times and how to charge the backup battery.
- Using the optional CH-910 Dual Battery Charger/Holder you can power the camera from two battery packs for longer continuous recording. You can exchange the battery packs independently without cutting the power to the camcorder. In addition, the CH-910 can charge two batteries consecutively when it is connected to an AC outlet.

## CA-910 Compact Power Adapter

### Specifications

<b>Power supply</b>	100–240 V AC, 50–60 Hz
<b>Power consumption</b>	16 W
<b>Rated output</b>	Adapter mode: 6.0 V, 1.7 A DC Charger mode: 8.4 V, 1.2 A DC
<b>Operating temperature range</b>	32°F–104°F (0°C–40°C)
<b>Dimensions</b>	2 1/2 × 5 × 1 3/4 in (63 × 127.5 × 43 mm)
<b>Weight</b>	10 7/8 oz (310 g)

Weight and dimensions are approximate.

Errors and omissions excepted.

Subject to change without notice.

When replacement or repair of any product including power supply is required, please return it to the nearest authorized Canon Service Center and have it repaired or replaced with the same number product or equivalent.

## Loading a Cassette

E

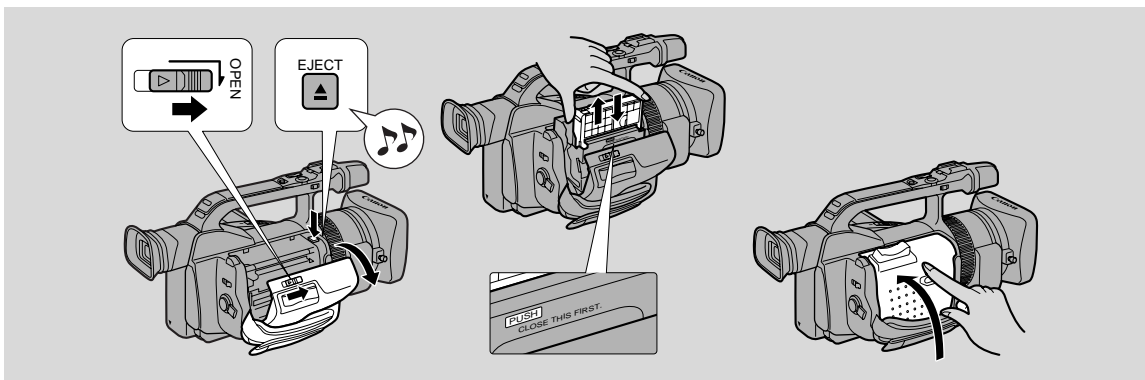

Only use videocassettes marked with the Mini DV logo.\*

### Loading and unloading

1. **Make sure that you have attached a power source.**
2. **Slide the OPEN button across to release the cover.**
  - Pull the cover fully open (while holding the button in the OPEN position).
3. **Press the EJECT  $\blacktriangle$  button and wait for the cassette compartment to open.**
  - The confirmation beep sounds.
4. **Load or unload the cassette.**
  - Insert the cassette gently with the window facing out and the REC/SAVE tab to the top.
  - Remove the cassette by pulling it straight out.
5. **Press the **PUSH** mark on the compartment until it clicks.**
6. **Click the cover back into place.**

\* Mini DV is a trade mark.

#### Notes:

- After loading a cassette, use record search (p. 47) to find the point where you want to start recording.
- Do not interfere with the cassette compartment while it is opening or closing, or attempt to close the cover.
- Be careful not to get your fingers caught in the cassette compartment cover.
- Do not leave the cassette in the camera after use — return it to its case and store it in a cool, clean, dry place.
- When a cassette is not loaded,  $\text{[REMAINING TIME]}$  flashes in the display.
- With some types of tapes, the remaining tape display may not give an accurate reading (p. 95).

## Protecting tapes from accidental erasure

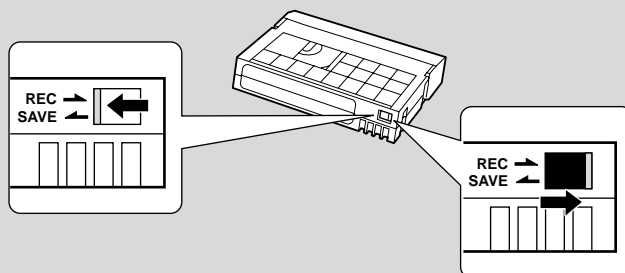

To protect your recording from accidental erasure, slide the tab on the cassette so that it exposes the hole and the red mark. (This switch position is usually labeled SAVE or ERASE OFF.)

If you load this cassette and put the camera in record pause mode (p. 21), “THE TAPE IS SET FOR ERASURE PREVENTION” is displayed for approx. 4 seconds and then the  mark flashes in the display. The camera also shows the above phrase if you accidentally press the ● (record) button with the camera switched to VCR mode.

If you want to record on the cassette again, slide the tab back so the hole is closed.

## Handling cassettes

- To protect the tape heads, transfer cassettes directly from the tape case to the camcorder — do not open the tape protect cover or touch the tape itself.
- Do not use cassettes where the tape has been damaged or spliced — they may damage the camcorder.
- Do not insert anything into the small holes on the cassette or cover them with cellophane tape.
- Handle cassettes with care — dropping them or exposing them to external shocks may cause internal damage.
- Store cassettes in the provided case, rewinding them to the start of the tape first, and then storing them upright.
- A cassette with metal plated terminals may become dirty with use, affecting information transfer. Therefore, after using a tape around ten times, be sure to clean the terminals with a cotton swab.

## Cassette memory

You are unable to use the cassette memory function with this camcorder.

## Basic Recording

E

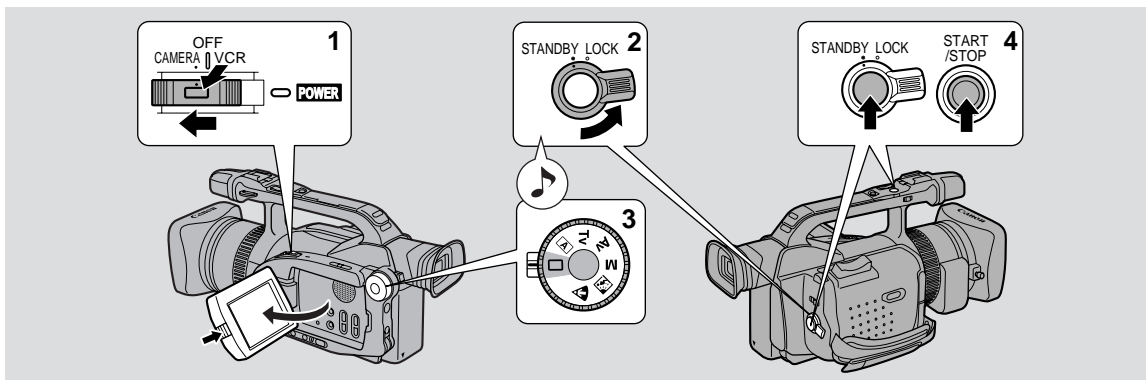

### Before you start recording

- Attach a power source (p. 16).
- Load a cassette (p. 19).
- Fasten the grip belt (p. 82).
- Attach the lens hood (p. 15).
- Choose the display: viewfinder (p. 82) or LCD screen (p. 25).
- Adjust the viewfinder or the LCD screen.

You may also want to charge the backup battery (p. 84) in order to set the date and time display (p. 39). To set the movie mode, refer to p. 46.

### To record

- 1. Press down and slide the POWER switch to CAMERA.**
- 2. Turn the standby lever to STANDBY.**
  - The confirmation beep sounds.
  - The camera power indicator lights up red and PAUSE appears in the display — the camera is now in “record pause mode”.
  - The camera will turn itself off if you leave it in record pause mode for more than about five minutes. To return to record pause mode, turn the standby lever to LOCK and back to STANDBY, or slide the POWER switch off and back on.
- 3. Turn the program selector to  Easy Recording mode.**
  - This selects the camera’s Easy Recording program. It allows you to simply point and shoot without making any manual adjustments (see p. 48).
- 4. Press the start/stop button to begin recording.**
  - There are two start/stop buttons, to give you control from both gripping positions.
  - The tally lamp flashes rapidly and REC appears in the display.
- 5. Press the start/stop button again to pause recording.**
  - The camera returns to record pause mode and PAUSE reappears in the display.
  - You can stop and restart recording as often as you like by pressing the start/stop button.

### Using the STANDBY lever

As long as the POWER switch is set to CAMERA, you can use the STANDBY lever to turn the camera on and off. This makes it easy to save battery power, and prevents accidental operation of the start/stop button.

Turn the STANDBY lever to LOCK and back to STANDBY to enter/leave standby mode.

## When you have finished recording

- Close the LCD panel.
- Unload the cassette.
- Turn the standby lever to LOCK.
- Slide the POWER switch to OFF.
- Disconnect the power source.

(If you have used the viewfinder, return it to its lowered and retracted position.)

### Notes:

- To check that the camera is recording correctly, make a test recording first.
- Before making important recordings, clean the video heads using a Canon DVM-CL Digital Video Head Cleaning Cassette or a commercially available digital video head cleaning cassette.
- To close the LCD panel, rotate it vertically until the screen faces you, then push it in flat against the side of the camera.
- You cannot monitor the sound from the speaker when recording.
- For tips on how to make better videos, see page 31.
- For extra recording time, set REC MODE in the camera menu to LP.
- The flashing of the tally lamp may be reflected into the lens during close-up recording, or when recording through glass. You may therefore decide to turn it off (p. 38).

## Changing the recording mode (SP/LP)

You can record and play back a tape in SP (standard play) and LP (long play) modes. LP extends tape usage by 1.5 times.

To switch to LP mode, select REC MODE from the camera or VCR menu, select LP and then close the menu (for instructions on how to use the menus, refer to page 35).

You can't add sound (audio dubbing) or images (A/V insert) to a tape that has been recorded in LP mode. If you plan to use either of these functions later, record in SP mode.

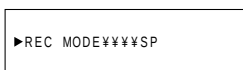

### Notes:

- When recording and playing back tapes in LP mode, the nature of the tape and usage conditions may affect recording, mosaic-like noise may appear in the image and the sound may be distorted during playback of tapes recorded in LP mode. For important recordings, therefore, set the camera to SP mode.
- If you record in both modes on the same tape, the picture may become distorted during playback and the time code may not be written correctly.
- When the camera is set to LP mode, pausing between recordings may produce mosaic-like noise.
- A tape recorded in LP mode on another camcorder may produce mosaic-like noise when played back on this camcorder, and vice versa.

## Turning the camera recording displays ON/OFF

You can show/hide non-essential camera recording displays by pressing the DISPLAY/DATA CODE button.

You cannot hide the following:

- Recording displays (REC, PAUSE etc.)
- Remaining battery power, flash information display
- Caution phrases (“CONDENSATION HAS BEEN DETECTED,” etc.)

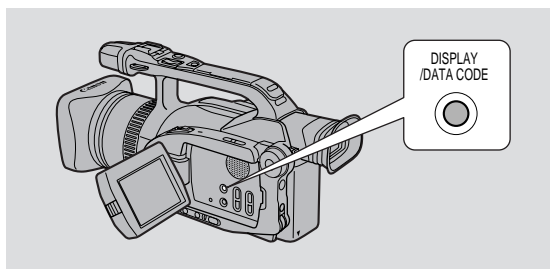

Even if you have the displays hidden, all displays will appear for 4 seconds if you operate any of the recording functions.

All displays will appear for 8 seconds if ND ON, ND OFF, the Tv mode shutter speed value or the Av mode aperture value starts to flash.

### Notes:

- You cannot hide the displays when in  Easy Recording mode.
- If you slide the POWER switch to OFF, the displays will be reset to appear.

## Microphone attenuator

Use the microphone attenuator if during recording or audio dubbing you need to lower the volume level or correct audio distortion of the input audio. Monitor the level of the input sound with headphones and if necessary, turn the attenuator on through the camera or VCR menu by selecting MIC ATT and setting it to ON.

## Confirmation/Warning beeps

The camera's short operation confirmation beeps are indicated by  in the illustrations. One beep sounds when you turn the power on. A series of beeps also sound during the self-timer countdown, right before the camera's automatic shut-off and upon any unusual condition of the camera. Beeps are not recorded on the tape. You can turn them OFF through the menu.



▶BEEP¥¥¥¥¥¥¥¥ON

## Demonstration mode

To see a demonstration of the camera's main features, before loading the cassette, go to the DEMO MODE option in the camera menu. Select the ON setting and close the menu. The demo also starts automatically if the power has been on for 5 minutes without a cassette loaded into the cassette compartment. (You can avoid this by turning the DEMO MODE to OFF through the camera menu.) To cancel the demo mode once it has begun: press a camera operation button such as the menu button or the zoom control, turn off the power, or load a cassette.



▶DEMO MODE¥¥¥ON

# Zooming

E

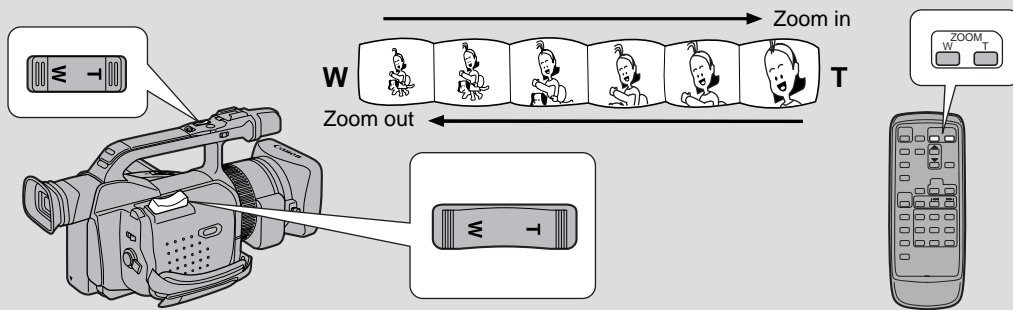

## 20× optical zoom

Operate the zoom controls from either the side grip, the camera handle or the wireless controller. The camera's 20× zoom lens allows you to choose the best picture angle for each scene:

- Press the zoom control towards W to zoom out to wide-angle.
- Press it towards T to zoom in to telephoto.

You can control the speed of zooming from the side grip:

- Press the control slightly to zoom slowly.
- Press it farther to zoom more quickly. (The farther you press the zoom control, the faster the zoom speed.)

The T and W buttons on the wireless controller and the camera handle adjust the picture angle, but not the zoom speed. Set the handle-top zoom control to one of three speeds. Open the camera menu and select ZOOM HANDLE , then set it to LOW, MEDIUM or FAST. The speed of the zoom control on the wireless controller cannot be adjusted.

Quick Overview

## 40×/100× digital zoom

Turn the digital zoom on by choosing D.ZOOM from the camera menu, to magnify the camera's zoom range by up to 5×.



The zoom control continues to work as usual. You can freely zoom in and out between 1× and 40× or 1× and 100× magnification — the camera automatically switches between optical zooming (up to 20×) and digital zooming (20× to 100×).

### Notes:

- When zooming, as a rule, keep at least one meter between you and your subject. However when the zoom is at the wide-angle position, you can focus on a subject as close as 3/8 in (1 cm).
- Image resolution decreases the further you zoom towards 100× in digital zoom range.
- When the digital zoom is set to 40×, the zoom indicator extends (light blue).  
When the digital zoom is set to 100× zoom, the zoom indicator extends again (a darker blue).



## Using the LCD Screen

### Open the LCD screen

Push the LCD panel open button and open the panel by pulling it away from the camera. This automatically switches the LCD screen on and the viewfinder off. When you close the LCD panel, the LCD screen automatically switches off and the viewfinder switches back on.

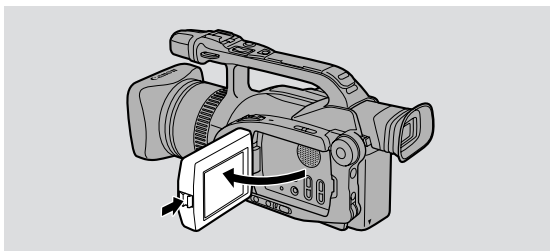

E

### Changing the angle of the LCD screen

First open out the LCD panel at a right angle (90°) to the camera.

You can now choose the angle of the panel that suits you best by rotating it backwards (up to 180°) and forwards (up to 90°) about this axis.

If you rotate the panel backwards around to 180° you can allow the subject to monitor the shot in the LCD screen or you can include yourself in the picture. The viewfinder is also activated when the panel is in this position.

From this position you may also push the panel flat against the camera, with the screen facing outwards.

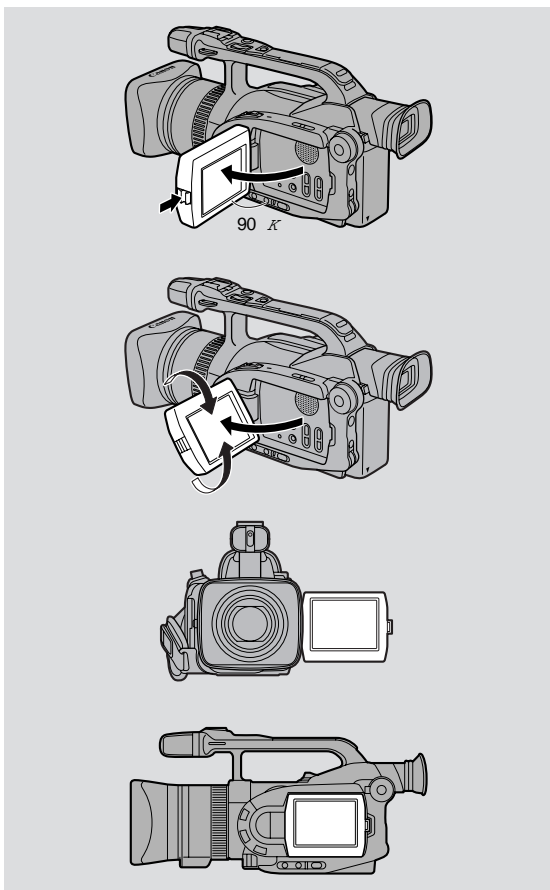

#### Notes:

- Avoid touching the LCD screen when moving the LCD panel.
- Do not hold the camera by the LCD panel or the viewfinder.
- Make sure you open the LCD panel at 90°, before attempting to rotate it backwards or forwards.
- Always rotate the LCD panel vertically into place, before closing it or pushing it flat against the side of the camera.
- Always fully close the LCD panel when it's not in use.
- Be careful not to leave the LCD, viewfinder or lens exposed to direct sunlight outdoors or in a window. Doing so could cause damage.
- Bright light falling on the LCD screen may cause glare that makes it difficult for you to view the image. In this case, switch to using the viewfinder. You are also able to adjust the brightness of the screen (see "Adjusting the LCD screen" p. 26).

## Adjusting the LCD screen

You can adjust the brightness of the LCD screen. Adjust the level with the +/- LCD BRIGHT buttons.

A bar showing the level appears in the display and disappears after 4 seconds.

- Press the + button to make the display brighter.
- Press the – button to make the display darker.

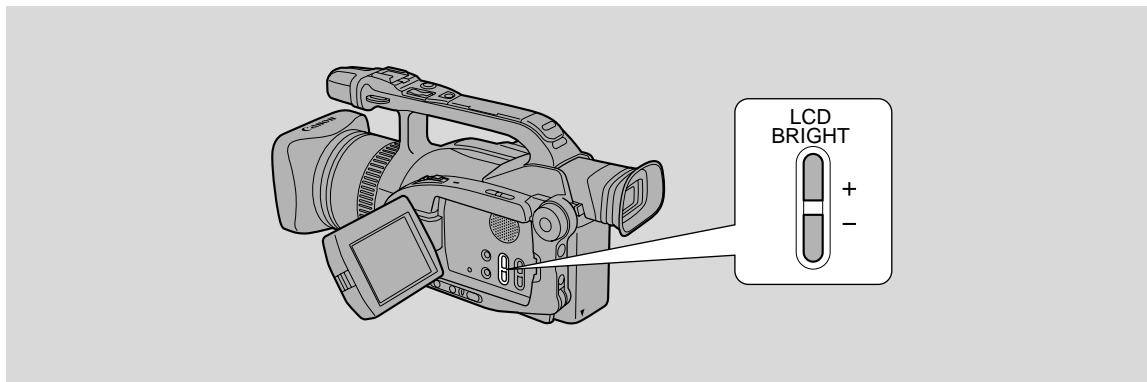

### Notes:

- The camera will remember your brightness setting even if you slide the POWER switch to OFF.
- The brightness of the LCD does not effect that of the recorded images or the viewfinder.

### About the LCD Screen

The LCD screen built into this camcorder is a high precision product.

However, small black dots or bright points of light (red, blue or green) may appear constantly on the LCD screen. This is not a malfunction of the LCD screen and they are not recorded on the tape. (Effective dots: more than 99.99%)

## Allowing the subject to monitor recording

When you turn the LCD panel so that it faces the opposite direction (see diagram opposite), you can let your subject monitor recording, or you can include yourself in the picture.

- You can choose the display style, reversed (mirror on) or not (mirror off) from the camera menu.

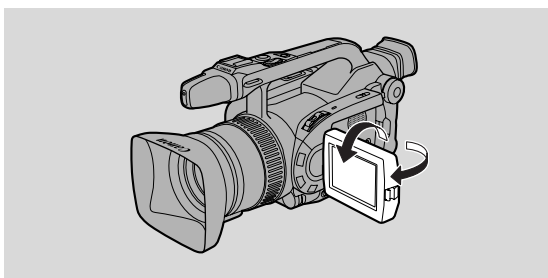

**MENU**  
(see p. 34)

▶ MIRROR ¥ ¥ ¥ ¥ ¥ ¥ ON

### Note:

- If you choose the mirror-on, the recording itself is unaffected.

## Indicators that appear in the LCD display when “mirror” is selected:

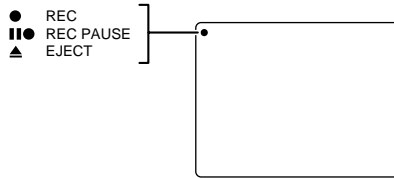

- All indicators appear normally in the viewfinder.

## Built-in speaker and headphone terminal

The camcorder has a built-in speaker and a headphone terminal so you can review the sound track alongside the picture during playback. Use the speaker or headphones when viewing playback with the LCD screen, and use headphones when viewing with the viewfinder. The built-in speaker is monaural; use headphones for stereo sound.

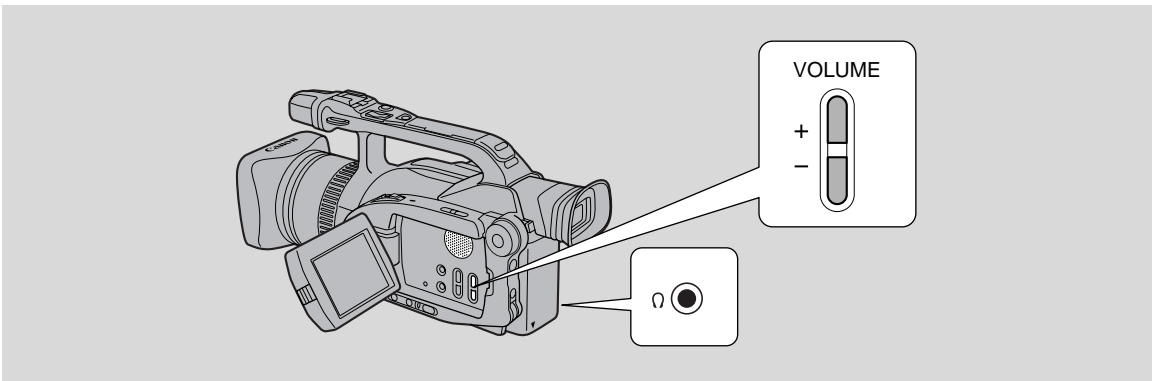

Adjust the speaker and headphone volume with the +/- VOLUME buttons.

- Press the + button to increase the volume, and the – button to lower the volume.
- A VOLUME bar appears in the display to indicate the current volume. It disappears in four seconds.
- You can turn off the volume completely by pressing the – button until OFF appears.
- You can also adjust the headphone volume separately from the built-in speaker, either during VCR mode or camera mode. The volume level is the same regardless of mode.
- The levels you adjust for the built-in speaker and headphones are memorized separately. The camera remembers your levels even if you slide the POWER switch to OFF.

### Notes:

- The speaker turns off when the camera is set to camera mode or when you use headphones.
- Sometimes the playback picture becomes rough with “noise”, when the volume is turned up high. If this happens, turn down the volume.

## Playing Back a Cassette

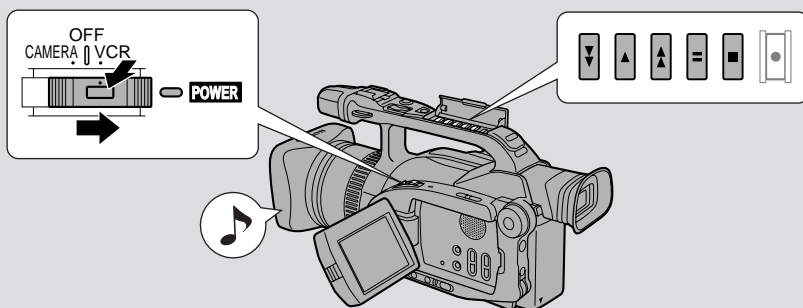

You can use the LCD screen or the viewfinder for instant, on-the-spot playback. The camera also plays back the sound track via the built-in speaker (p. 27).

- When you play back a tape, you can close the LCD panel with its screen side facing up.
- When the LCD panel is closed, you can monitor the playback using the viewfinder.

To play back your recordings on a TV, see p. 30.

To use the wireless controller, see p. 36.

### Note:

- To avoid accidental recording, make sure that you slide the tab on the cassette so that it exposes the hole (the switch position is usually labeled SAVE or ERASE OFF).

### 1. Attach a power source and slide the POWER switch to VCR.

- The power indicator lights up green.
- The confirmation beep sounds.

### 2. Load the cassette.

### 3. Press the PLAY ► button to start playback.

- Open the cover to use the handle-top buttons.
- To end playback, press the STOP ■ button.
- To wind the tape forwards, stop playback and press the FF ►► button.
- To wind the tape backwards, stop playback and press the REW ◀◀ button.
- If the playback picture is rough (mosaic-like noise), clean the video heads using a Canon DVM-CL Digital Video Head Cleaning Cassette or a commercially available digital video head cleaning cassette.

## Other playback modes

### Playback Pause

To view the video as a still picture press the PAUSE ||| button. To resume normal playback, press it again, or press the PLAY ► button. The camera automatically goes into stop mode after about five minutes' playback pause.

### Fast Forward Playback

To play back the recording at about 9.5 times normal speed, press and hold the FF ►► button during normal playback or press and hold the FF ►► button during normal fast forward.

### Rewind Playback

For reverse playback at about 9.5 times normal speed, press and hold the REW ◀◀ button during normal playback or press and hold the REW ◀◀ button during normal rewind.

## Special playback

These can only be operated from the wireless controller (p. 36).

### Frame Advance

To play back frame by frame, press the +/▶▶▶ button repeatedly during playback pause. Press and hold to play back continuous frame advance.

### Frame Reverse

To play back in reverse frame by frame, press the -/◀◀◀ button repeatedly during playback pause. Press and hold to play back continuous frame reverse.

### Slow Forward Playback

To play back at about 1/5 normal speed, press the SLOW ▶▶ button during normal playback. Press the PLAY ▶ button to return to normal playback.

- The camera automatically returns to playback after about 30 seconds of slow playback.

### Slow Reverse Playback

To play back in reverse at about 1/5 normal speed, press the -/◀◀◀ button and then the SLOW ▶▶ button during normal playback.

Press PLAY ▶ to return to normal playback.

- The camera automatically returns to ×1 reverse playback after about 30 seconds of slow playback.

### Reverse Playback

To play back in reverse at normal speed, press the -/◀◀◀ button during normal forward playback. Press the PLAY ▶ button to return to normal forward playback.

### Forward ×2 Playback

Press the ×2 button during normal playback.

Press the PLAY ▶ button to return to normal playback.

### Reverse ×2 Playback

Press the -/◀◀◀ button and then the ×2 button during normal playback.

Press the PLAY ▶ button to return to normal playback.

### Notes:

- Mosaic-like noise appears on the screen during some of the VCR modes.
- There's no audio during special playback.

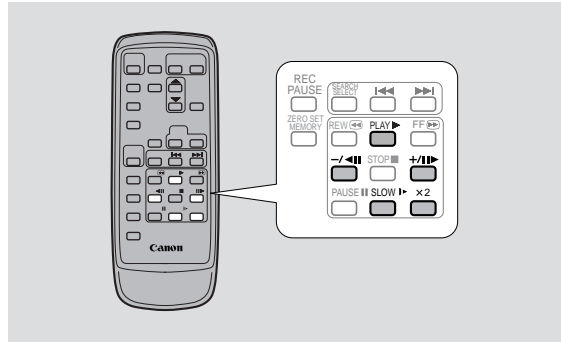

## Connections for Playback on a TV Screen

E

You can connect the camera to a TV or VCR in order to play back your recordings. You will need to attach a power source to the camera (see p. 16).

See your TV or VCR instruction manual for further details.

### If your TV (or VCR) has an S-video input terminal

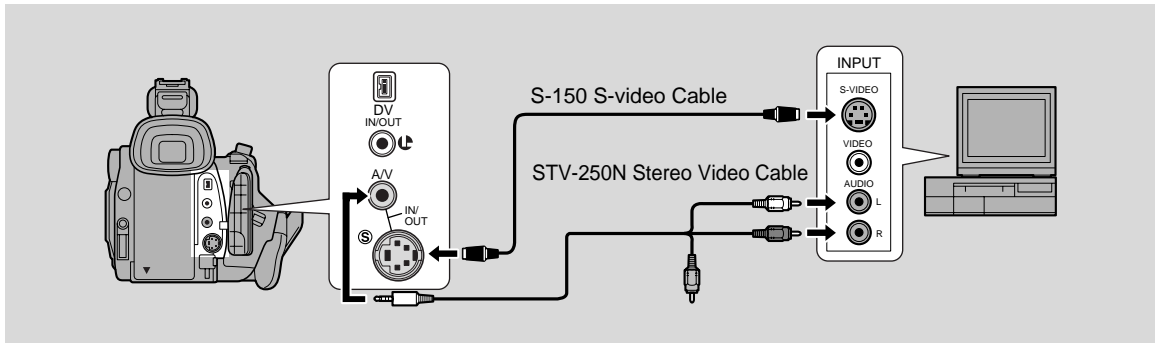

- Use the S-150 S-video Cable to connect the S-video terminal (S). Use the STV-250N Stereo Video Cable, to connect the AUDIO terminals. Connect the white plug to the white AUDIO terminal **L** (left). Connect the red plug to the red AUDIO terminal **R** (right). Do not connect the yellow plug.
- Set the TV/VIDEO selector on the television to VIDEO.
- If you are connecting the camera to a VCR, set the input selector on the VCR to LINE.

Quick Overview

### If your TV (or VCR) has audio/video input terminals

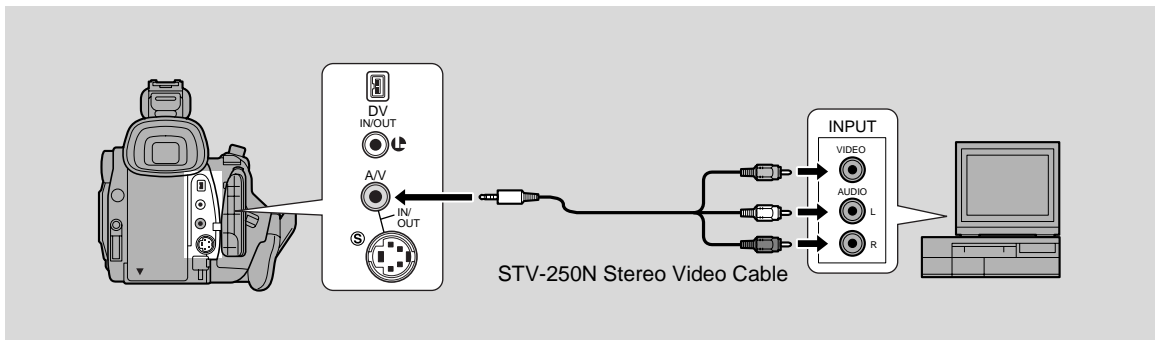

- Connect the camera using the STV-250N Stereo Video Cable. Connect the white plug to the white audio terminal **L** (left). Connect the red plug to the red audio terminal **R** (right). Connect the yellow plug to the yellow video terminal **V**.
- Set the TV/VIDEO selector on the television to VIDEO.
- If you are connecting the camera to a VCR, set the input selector on the VCR to LINE.

#### Note:

- If you are going to use the TV as a monitor while you are shooting, remember to keep the TV volume turned down as long as the camera's audio terminals are connected. If the sound from the TV speakers is picked up by the microphone, an unpleasant high-pitched squeal, called feedback may be produced.

If your TV is already hooked up to a VCR, you can connect the camera to the VCR instead of the TV. Follow the instructions above.

## Tips for Making Better Videos

E

### Holding the camera

For maximum stability, grip the camera in your right hand and keep your right elbow pressed against your body.

If necessary support the camera with your left hand. With practice, you will be able to operate the controls by touch, without taking your eye off the action.

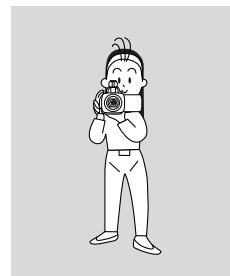

### Using a tripod

To prevent any unwanted movement, you can mount the camera on a tripod, (or any flat surface at a suitable height) and operate it with the wireless controller.

- When you are using a tripod, be careful not to leave the viewfinder exposed to bright sunlight or it may melt. (The light is concentrated by the viewfinder lens.) Change the angle of the viewfinder so that the sun doesn't shine into it.
- Make sure that the fastening screw of the tripod is no longer than 1/4 inch (5.5 mm), or it will damage the camera.

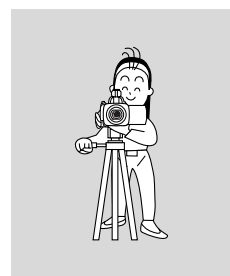

### Sound recording

For greater creative control, you can connect an external microphone to the MIC terminal.

We recommend a microphone with a built-in power supply (condenser microphone).

It is possible to connect almost any stereo microphone with a plug diameter of 3.5 mm.

- Use the microphone attenuator with the built-in or an external microphone if you need to lower the volume level of the input audio. Monitor the level of the input sound with headphones and if necessary, turn the attenuator on through the menu by selecting MIC ATT and setting it to ON.

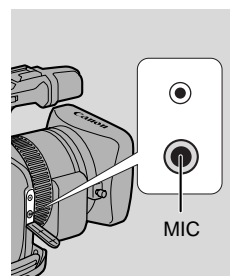

## Composition

The most important element in the scene does not have to be in the center. For a more interesting picture, try to position your subject so it is slightly to one side. Leave some space on the side of the frame that the subject is facing or moving towards.



Don't cut off the top of the subject's head, and don't cut people off at the neck, hips or knees (move a little bit above or below).

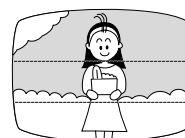

Watch out for distracting objects in the background.



## Picture angle

Instead of zooming while recording, try to choose your picture angle before you begin. A good way to tell a story with video is to begin with a long shot that establishes the situation, and then move in with medium shots and close-ups to show the details. Remember to change your viewpoint for each shot.



Long shot



Medium shot



Close-up

Remember that any camera movement or change in picture angle should have a definite purpose. Avoid unnecessary or half-hearted movements.

## Camera moves

Use pans to record a landscape or follow a moving subject. Decide the area you want to cover and stand facing the end of your panning angle. Without moving your feet, turn your waist to the starting position. Start recording, and after a few seconds begin to turn slowly from the waist. Hold the final image for a few seconds before you stop recording.

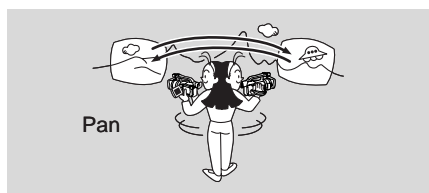

Pan

Tilt the camera up to exaggerate the height of the subject. Tilt down from the top of a building, for example, as an introduction to subjects at the bottom.

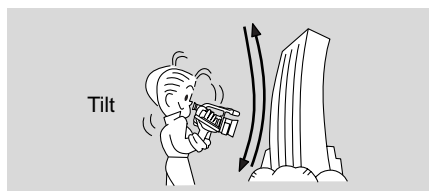

Tilt



## Turning the Optical Image Stabilizer Off

E

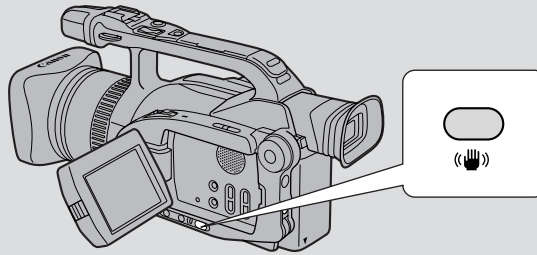

With most camcorders, even the slightest hand movements will be noticeable during telephoto recording. However, the GL1's Optical Image Stabilizer allows you to obtain steady recordings even at high magnification. Unlike electronic image stabilizers, it causes no loss of picture quality. The Optical Image Stabilizer can compensate for a wide range of camera movement — you can record stable images even if you are shooting from a moving car.

Before you start recording, push the (👤) on/off button to turn the image stabilizer on or off.

- The (👤) mark appears in the display when the stabilizer is on.
- The image stabilizer cannot be turned off when the program selector is set to the □ (Easy Recording) position.

### Notes:

- The camcorder remembers your selection if you turn the standby lever to LOCK. However, it resets to the on setting if you slide the POWER switch to OFF.
- The image stabilizer is designed to deal with a normal degree of camera shake.
- Keep the image stabilizer turned off when the camera is mounted on a tripod.

# Selecting from the Menu

E

Many of the camera's advanced functions are selected from menus which appear in the display. You must first pause recording before the functions in the menu can be changed.

There are two main menus:

1. **Camera menu (when the camera is in record pause mode: the POWER switch set to CAMERA and the standby lever set to STANDBY)**
2. **VCR menu (when the camera is in VCR mode: the POWER switch is set to VCR)**

## Camera menu (CAM.MENU)

- 1 Zebra pattern.....p. 62
- 2 Digital effects .....p. 51
- 3 Digital zoom .....p. 24
- 4 Handle-top zoom control.....p. 24
- 5 AE shift.....p. 59
- 6 16:9 effect.....p. 52
- 7 Camera sharpness .....p. 60
- 8 Camera color phase .....p. 61
- 9 Wireless remote .....p. 37
- 10 Tally lamp .....p. 38
- 11 Record mode.....p. 22
- 12 Wind screen .....p. 53
- 13 Microphone attenuator.....p. 23, 80
- 14 Audio mode .....p. 53
- 15 Confirmation beeps.....p. 23
- 16 Mirror mode.....p. 26
- 17 TV screen displays .....p. 95
- 18 Demonstration mode.....p. 23
- 19 Date/time display .....p. 41
- 20 Time zone/Daylight saving time .....p. 39
- 21 Date/time set.....p. 40

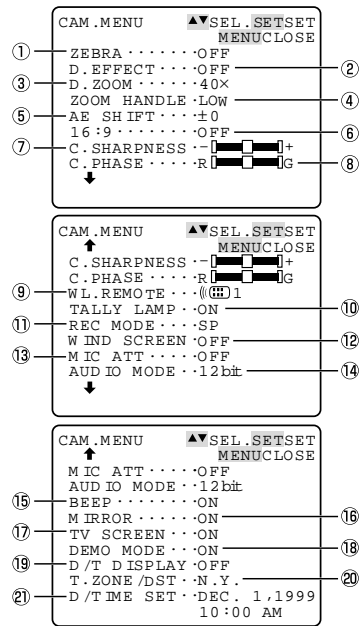

## VCR menu

- 1 To dub mode .....p. 69
- 2 To recorder set up .....p. 70
- 3 Wireless remote .....p. 37
- 4 Record mode.....p. 22
- 5 Data code .....p. 65
- 6 Date/time select .....p. 41
- 7 Displays .....p. 95
- 8 6-second auto date .....p. 41
- 9 Output channel.....p. 87
- 10 Audio dubbing .....p. 81
- 11 Wind screen .....p. 53
- 12 Microphone attenuator.....p. 23, 80
- 13 Line audio attenuator.....p. 80
- 14 Audio mode .....p. 53
- 15 Confirmation beeps.....p. 23

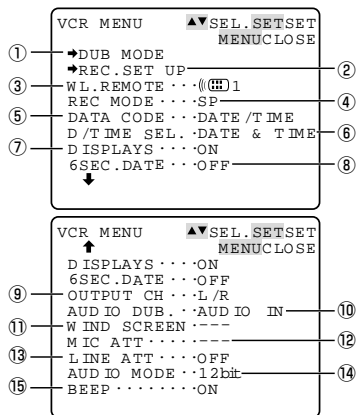

Turn to the appropriate page for a detailed explanation of each function.

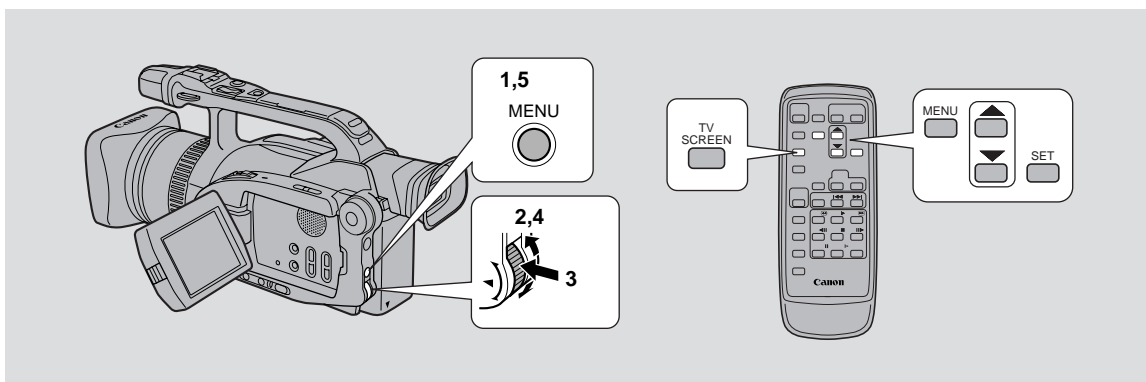

You can also close the LCD panel with its screen facing up when you select items from the menus.

- 1. Press the MENU button to open the menu.**
- 2. Turn the menu dial up or down to move the arrow up or down the display.**
- 3. Press the menu dial in to select your chosen option from the menu.**
  - Your selected option remains on the screen and all other options are removed.
- 4. Turn the menu dial up or down to choose its setting.**
- 5. Press the MENU button to close the menu.**

#### Notes:

- You can only see eight options on the screen at one time. Pointers at the top/bottom of the screen indicate that there are more options that you can scroll through.
- Unavailable functions appear in purple. (Factors such as recording program determine which functions are available.)
- You may often find it convenient to use the wireless controller to move around the menus. Press its MENU button to enter/leave the menu and use the arrow keys in place of turning the menu dial. Push the SET button to select.
- Pushing the start/stop button or the PHOTO button will close the menu and start recording.
- You can display the menus on a connected TV screen using the wireless controller's TV SCREEN button. See p. 30 for TV hookup instructions.
- The camcorder will remember your chosen menu settings even if you slide the POWER switch to OFF.

## Using the Wireless Controller/Tally Lamp

E

The supplied wireless controller can operate the camera from a distance of up to 16 feet (5 m). Point it at the camera's remote sensor while you press the buttons.

The tally lamp lights up to let you know that the camera is in range and responding to your commands.

There are six functions which can only be operated using the wireless controller:

- Special playback (p. 29)
- Photo/date search (p. 67)
- Zero set memory (p. 68)
- Audio mix (p. 86)
- A/V insert (p. 78)
- Audio dubbing (p. 80)

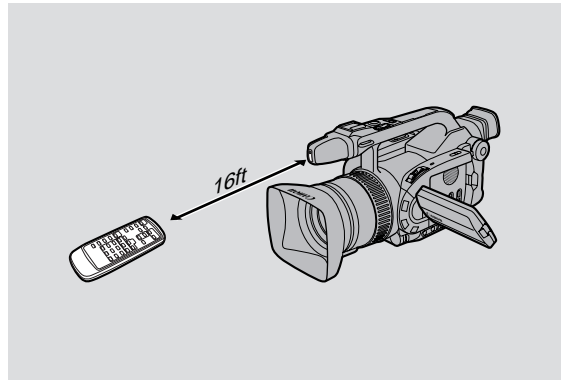

### Inserting batteries

Insert two AA batteries, following the ⊕ and ⊖ markings. Be careful not to reverse the polarity of the batteries.

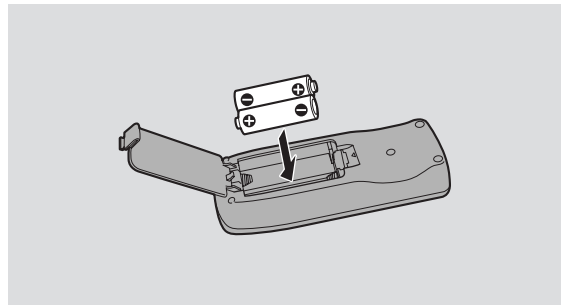

#### Notes:

- When using the wireless controller in brightly lit places or outdoors, the effective range will be less.
- The camera may have difficulty picking up the remote control signals at extremely close range.
- Do not leave the controller exposed to direct sunlight, or in hot or humid places.
- When the batteries run out, replace them both together.
- Make sure the shoulder strap does not obstruct the remote sensor.

## Setting the remote sensor mode

To prevent interference from other Canon wireless controllers being used nearby, there are two remote sensor modes and an off setting. The wireless controller and the camera have to be set to the same mode in order to be compatible.

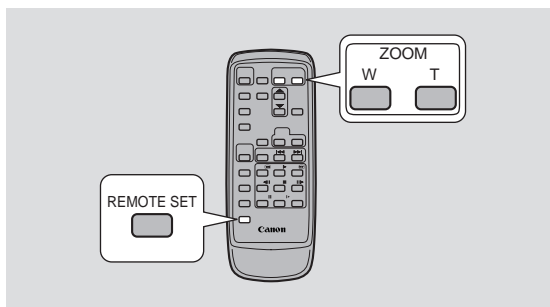

The wireless controller and the camera have been preset to mode 1. If you change the mode on the camera, be sure to change the mode on the wireless controller to the same mode.



1 : Mode 1  
 2 : Mode 2  
 OFF : Sensor off

To turn the remote sensor off:

1. Open either the camera or the VCR menu and select **WL.REMOTE**.
2. Choose **OFF** and close the menu.
  - appears in the display.

To change the mode...  
...on the camera:

1. Open either the camera or the VCR menu and select **WL.REMOTE**.
2. Choose 1 (mode 1) or 2 (mode 2) and close the menu.
  - The selected mode will appear on the display for four seconds.

...on the wireless controller:

- Press and hold the REMOTE SET button on the wireless controller. Simultaneously press the ZOOM W button for mode 1 or the ZOOM T button for mode 2. Continue to press simultaneously for over two seconds.**
- Be sure to set the wireless controller to the same mode as the camera.

To confirm the mode settings for the camera and the wireless controller, follow the following steps.

### Notes:

- If your wireless controller isn't working, make sure the camera and the wireless controller are both set to the same mode. Check the mode the camera is set to by pushing any button other than the REMOTE SET button on the wireless controller. The camera's mode appears in purple for about four seconds. Set the wireless controller's mode accordingly by pressing the aforementioned button combinations. If the wireless controller still doesn't work, change the batteries.
- The mode the camera is set to also appears for four seconds when you turn the power on.

## Turning off the tally lamp

The tally lamp lets you know that the camera is recording. However, its flashing may be reflected into the lens during close-up recording, or when recording through glass.

You may therefore decide to turn it off.



**MENU**  
(see p. 34)

▶ TALLY LAMP · · ON

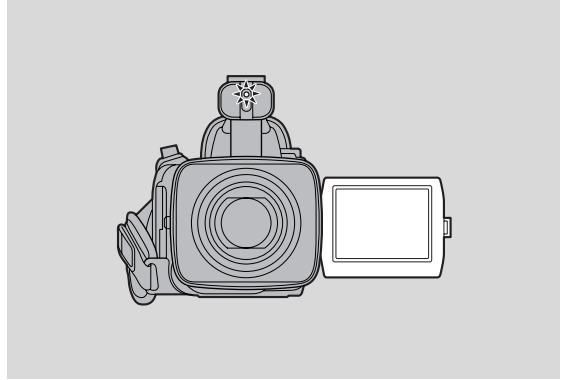

1. **Open the camera menu and point the arrow at TALLY LAMP.**
2. **Select the OFF setting and close the menu.**
  - The tally lamp no longer flashes during recording, but it will still light up when the camera receives a signal from the wireless controller.

## Setting the Date and Time

E

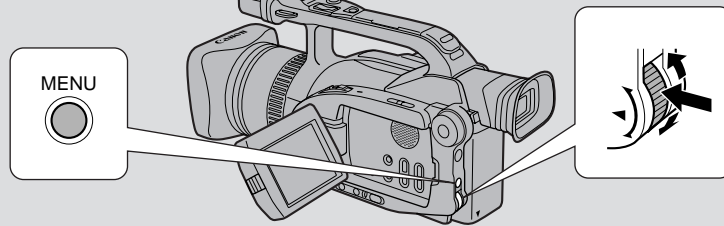

The date and/or time display forms part of the data code. You can choose to display or hide it during playback (see p. 65).

Set the date and time display when you first start using your camera. Charge the backup battery for a full day (approx. 24 hours) before you begin (see p. 84).

- Before you start setting the date and time, select your home time zone from the menu.
- If you are on daylight saving time now, you should set the camera to daylight saving time. You can do this at the same time you select your home time zone.
- After you set the date and time, the date/time and home time zone will be displayed for about four seconds each time you turn the power on.
- The camera automatically accounts for the number of days in a month and leap year.

### Setting the time zone/daylight saving time



▶ T.ZONE / DST · · N.Y.

- 1. Set the camera to record pause mode.**
  - PAUSE appears in the display.
- 2. Open the menu and select T.ZONE/DST.**
- 3. Press the menu dial in.**
  - The time zone display appears on the screen.
  - Your camcorder's time zone is factory-preset to New York. If you are at another time zone, select your time zone first and daylight saving time (DST) setting if necessary.
- 4. Move up or down the list of time zones by turning the menu dial. Press the menu dial in to select the option that represents your time zone.**
  - If you are now in daylight saving time, select the time zone with the daylight saving time mark  next to the area.
- 5. Press the MENU button.**

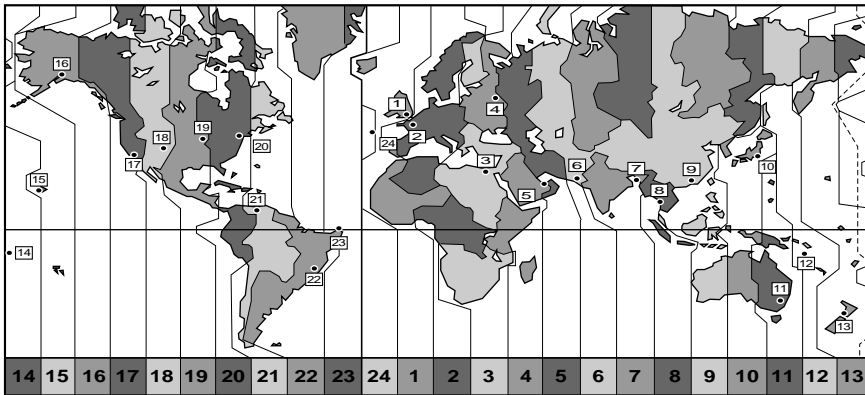

No.	Time zone	No.	Time zone
1	LONDON	13	WELLGTN (Wellington)
2	PARIS	14	SAMOA
3	CAIRO	15	HONOLU (Honolulu)
4	MOSCOW	16	ANCHOR (Anchorage)
5	DUBAI	17	L.A. (Los Angeles)
6	KARACHI	18	DENVER
7	DACCA	19	CHICAGO
8	BANGKOK	20	N.Y. (New York)
9	H. KONG (Hong Kong)	21	CARACAS
10	TOKYO	22	RIO (Rio de Janeiro)
11	SYDNEY	23	FERNAN. (Fernando de Noronha)
12	SOLOMON	24	AZORES

#### Note:

- After you have selected your time zone and set the date and time, when you travel to another time zone, there is no need to reset the date and time. Just set the time zone to your destination's representative city and the camera's clock will automatically change to display the correct time for your destination.

### Setting the clock



▶D/TIME SET•DEC. 1,1999  
10:00 AM

1. Put the camera in record pause mode.
2. Open the menu and select **D/TIME SET**.
  - The year display starts to flash.
3. Turn the menu dial up and down to change the year. Press the dial in to move to another part of the display.
  - Once you move from the year, the next part of the display starts flashing.
4. Set the month, day, hours, and minutes in the same way.
5. Press the **MENU** button when finished, and to start the clock.
  - The date can be set to any year between 1999 and 2020.
  - If you press the MENU button in the middle of setting the date and time the seconds are set to zero, you leave the menu, and the clock starts.
  - If you press the menu dial in after setting the minutes you can set the date and time again from the start.



## Setting the display style

Select whether you want the date, the time, or both to show up on your data code display (p. 66).



1. Turn the **POWER** switch to **VCR**.
2. Open the menu and select **D/TIME SEL**.
3. Choose between **DATE**, **TIME** and **DATE & TIME**.
4. Press the **MENU** button to close the menu.

## Date and time display

You can choose to display or hide the date and time display during recording. When the date and time display is set to **ON**, the date and time show in the display but the time zone disappears in about four seconds. It is not recorded onto your tape.



1. Put the camera in record pause mode.
2. Open the menu and select **D/T DISPLAY**.
3. Select **ON** and close the menu.

## Six-second auto date

The six-second auto date appears for six seconds to mark the changeover of a day if the tape was being recorded at 12:00 midnight. It also appears for six seconds when you start playback and have the data code turned off. The six-second auto date will adjust for any time zone changes you have indicated.



You can turn the six-second auto date on:

1. Turn the **POWER** switch to **VCR**.
2. Open the menu and select **6SEC.DATE**.
3. Select **ON** and close the menu.

### Note:

- When **6SEC.DATE** is turned on and **DISPLAYS** (p. 95) is turned off, the six-second auto date appears for six seconds.

## Using the ND Filter

E

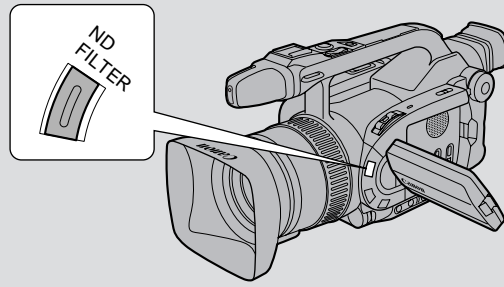

On bright days or when recording very bright scenes, despite the iris being at its smallest aperture, blurring of the image may occur. If this happens, using the ND filter should remove this problem.

Turn the ND filter on by pressing the ND FILTER button.

- ND is shown continuously in the display while the ND filter is turned on.
- ND ON flashes in the display to advise you to switch the ND filter on. (However it doesn't appear in the Manual mode or during exposure lock.)
- ND OFF with the "OFF" flashing warns you that the ND filter is no longer suitable for the current conditions. If this warning appears, turn the ND filter off by pressing the ND FILTER button again.

### Notes:

- You cannot turn the ND filter on/off during exposure lock or while the PHOTO button is pressed halfway down.
- The camcorder remembers your selection if you turn the standby lever to LOCK. However, it resets to the off setting if you slide the POWER switch to OFF.

## Taking Still Pictures (Photo Mode)

E

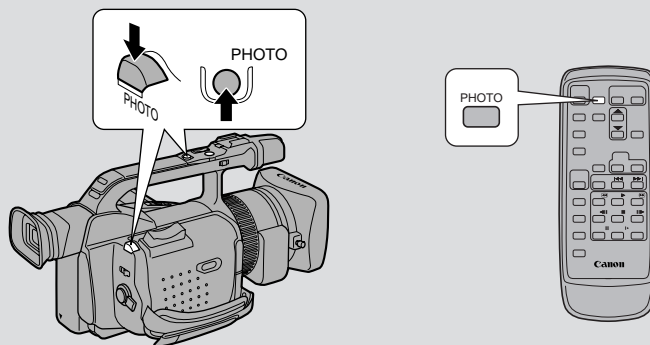

Take still photos to download into your PC for image enhancement and printout. Also, starting your shooting with a still photo makes it easy to find the beginning again later with the Photo Search function (p. 67).

You can record still pictures like a photograph. The camera records the picture and sound to tape for approximately 6 seconds. The exposure is automatically adjusted.

There are two PHOTO buttons, to let you take still images from both gripping positions, or, you can take still pictures from the wireless controller.

You can take a still picture at any time during regular video recording, or you can put the camcorder into record pause mode first, then take a still picture.

### 1. Set the camera to record or record pause mode.

### 2. Press the photo button halfway or all the way.

- If you are now in regular video recording mode, press the button all the way down, and the still picture will be taken immediately.
- If you press the button halfway down:
  - “PHOTO” flashes at the bottom right of the display.
  - Exposure is locked the instant the photo button is pressed halfway down.
  - During autofocus ● flashes white in the display as the camcorder adjusts the focus and it is displayed continuously as a green mark when the camera is ready to take the still picture.
  - To change the still picture before recording: release the button, select a new picture and then press down the PHOTO button lightly once more.
  - If the subject is unsuitable for autofocus (p. 93), the camera may not be able to focus, and ● may continue to flash white in the display. Press the PHOTO button down halfway and adjust the focus manually with the focus ring.
  - If you are using manual focus (p. 58), the ● mark starts as a continuous as a white mark. Focus with the focus ring.

### 3. Press the PHOTO button fully down to take the still picture.

- The camera takes the image almost immediately, and then records the “photo” to the tape for approximately 6 seconds. During this time the camera also records the sound, and the display also shows the still picture.
- A counter display is shown, that counts up to 6 secs as the camcorder records the picture.
  - disappears from the display.

**Notes:**

- While the camera records the still, you cannot use the camera functions (POWER switch/STANDBY lever do not respond until recording is complete). This applies even when you haven't loaded a cassette.
- The wireless controller's PHOTO button has no half-way setting, press the button fully and the camera immediately takes the "photo".
- For even greater versatility attach a Canon Speedlite for flash photography (available as optional accessories, see page 45), when taking still pictures directly from record pause mode.
- Only take "photos" where it is bright enough to see the image in the display.
- If you want to use an effect, make sure you set it before you take your picture (you cannot use the fade trigger while taking a still picture).
- Depending on the subject (fast moving subject, for example), the picture may be blurred.

## Using a Canon Speedlite for Flash Photography (optional)

For SLR-style flash photography, attach a Canon Speedlite 220EX, 380EX or 550EX to the camcorder's accessory shoe. Attach the Speedlite 380EX and 550EX with their locking collars as in the illustration. Attach the Speedlite 220EX with its hot shoe lock release.

Set the camera to record pause mode. Turn on the Speedlite using its main switch, and wait for it to charge. When you press the PHOTO button halfway down, the camera sets the autofocus and the zoom is locked. Pressing the PHOTO button fully down releases a pre-exposure flash that sets the flash intensity, exposure and white balance. The main flash is then sent out.

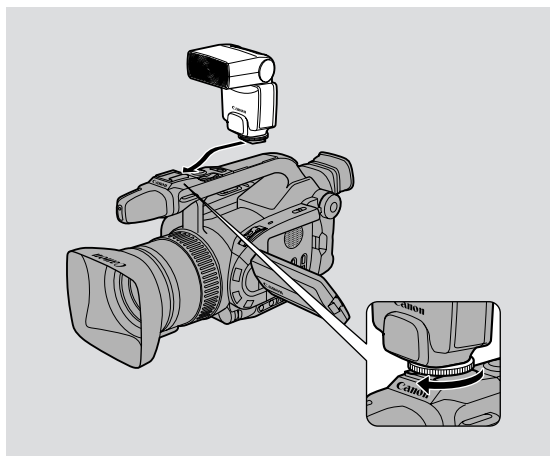

E

- In dark recording situations, during autofocus, a supplementary light beam is sent out by the Speedlite for approx. eight seconds to illuminate the subject while you hold the camera's PHOTO button halfway down.

### Flash Charging

While the Speedlite is charging, a white ⚡ flashes in the display.

When the Speedlite is fully charged a green ⚡ lights up constantly in the display.

- Although it is possible to record a still image while the Speedlite is still charging, the flash will not go off. In addition, the Speedlite cannot charge while you are holding the PHOTO button halfway down.
- ⚡ disappears from the display while the camera records the still picture.
- If the ⚡ mark does not appear in the display when you turn the Speedlite on, make sure that the Speedlite unit is slid fully onto the accessory shoe.

### Notes:

- For full details of how to use the Speedlite, refer to its instruction manual.
- If you use the Speedlite in the shutter-priority (Tv) mode, you can choose any shutter speed between 1/60 and 1/1000.
- In the aperture-priority (Av), you can choose any F number, but an F number of less than f/5.6 gives the best results.
- You cannot use the Speedlite with the:
  - Manual recording program.
  - Exposure Lock. (⚡ goes out if you press the EXPOSURE dial in. It reappears when you turn the lock off, by pressing the EXPOSURE dial in again.)
- Turn the Speedlite unit off when you do not require a flash.
- You are unable to use the bounce flash on the 380EX and 550EX Speedlites with the GL1.
- You cannot use the Speedlite Transmitter ST-E2 for the 550EX.
- You cannot use the 550EX's multiple Speedlite control.

## Choosing the Movie Mode (Normal/Frame)

E

The Frame mode can be used when you want to look at a video, scene by scene, free from field slippage (the “flicker” that normally occurs when you pause a video). The vertical resolution of the image is improved by 1.5×. During playback, pause the video any time you like to view a crystal clear still image in the display or on a connected TV screen. It is also possible to transfer your favorite still pictures to a PC for image enhancement and print out.

If you are going to play back movie normally, we recommend recording in normal movie mode.

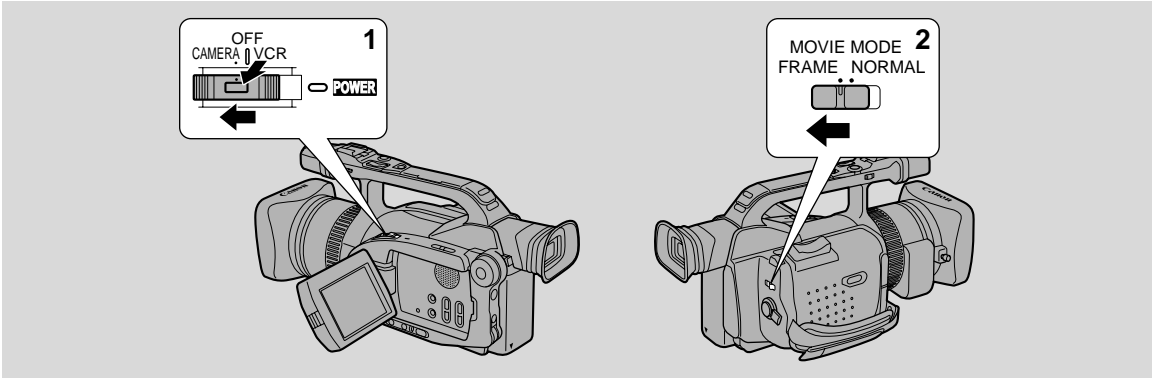

1. Set the camera to record pause mode.
2. Slide the MOVIE MODE switch to FRAME.
  - FRAME appears in the display.

### Notes:

- Frame mode cannot be used with the Easy Recording program.
- Frame video may not appear completely smooth during normal playback.
- Some subjects may not be suitable for Frame mode. You will often get better results when shooting everyday subjects using normal mode.

# Searching and Reviewing While Recording

E

## Record search

When the camera is in record pause mode, you can use record search to play the tape forwards or backwards to find the point where you want to start or restart recording. This is useful when you want to add a new scene to a previously used cassette. By using record search, you can ensure a smooth, noise-free join between the new scene and the old one.

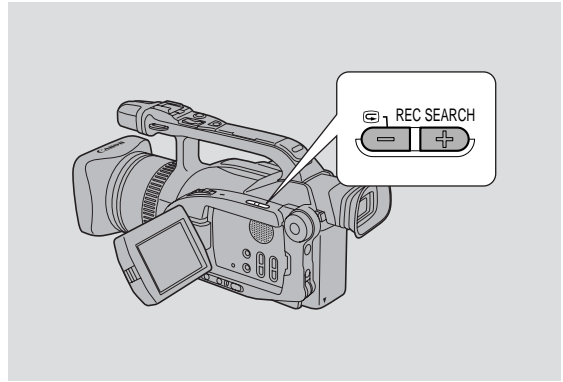

1. **Make sure the camera is in record pause mode.**
2. **Press and hold the REC SEARCH + or – button while you check the picture in the display.**
  - The + button plays the recording forwards and the – button plays it backwards.
3. **Release the button when you find the point where you want to start recording.**
  - The camera returns to record pause mode.

## Record review

When the camera is in record pause mode, you can use record review to play back the last few seconds of your recording and then return automatically to record pause mode. You can quickly make sure that a scene has recorded properly and then go on to shoot the next scene, without producing any noise in the picture.

1. **Make sure the camera is in record pause mode.**
2. **Press and release the  (record review) button while you check the picture in the display.**
  - The camera rewinds the tape, plays back the last few seconds, and returns to record pause mode.

### Note:

- Noise may appear on the screen during record search and record review.

# Using the Various Recording Programs

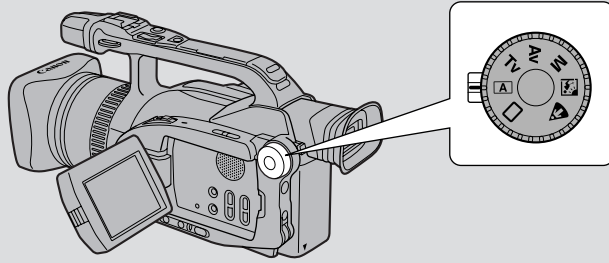

The camera provides you with a choice of seven recording programs. They use different combinations of camera settings in order to adjust the exposure and other functions to match the recording situation.

The name of your selected recording program appears constantly on the left of the display, with the exception of the AUTO Recording program whose mark is displayed and then disappears after 4 seconds.

**Notes:**

- Avoid changing programs during recording as the brightness of the image may change suddenly.
- The specialized AE programs are not suitable for all kinds of lighting. The image may flicker, or a bright line may appear on the screen if you use them in the wrong lighting conditions.

**Availability of functions in each recording program**

	Easy Recording	Auto	Tv (shutter priority)	Av (aperture priority)	Manual	Sand & Snow	Spotlight
Shutter speed	A		M	A	M		A
Iris	A		A	M	M		A
Gain	A		A	A	M		A
Exposure lock/ adjustment	×		M		×		M
AE Shift	×		M		×		×
White balance	A			M			
Focus	A			M			
Image stabilizer	ON			M			
Digital effects	×			M			
Camera sharpness and color phase	×			M			
16:9	×			M			

A=Automatic    M=Manual    ×=Not available

## Easy Recording

The simplest way to use the camera is with the program selector set to the position. The camera will take care of focus, exposure and other adjustments, leaving you free to point and shoot.





## Auto

In normal recording conditions, set the program selector to **A** (Auto). This is the same as the Easy Recording program, except that you now have the option of using any of the camera's manual functions.

**A**



## Giving priority to shutter speed (shutter-priority: Tv)

Use this program to select the shutter speed. The camera automatically sets all other values necessary to give the correct exposure. When you turn the program selector to Tv, the current shutter speed is shown in the display. Select your desired shutter speed by turning the EXPOSURE dial toward + for a slower shutter or – for a faster shutter.

**Tv**



You can choose 9 shutter speeds between 1/60 and 1/15000 of a second.

When shooting outside on clear, bright days, the camera will often set a large F number to adjust the amount of light entering the camera, throwing the focus off. Setting a fast shutter speed or decreasing the amount of light with the ND filter can help correct this.

- If you try to set a shutter speed that is either too high or too low for the shooting conditions, the indicator flashes in the display. In this case, increase or decrease the setting until the flashing stops, or turn the ND FILTER ON/OFF as appropriate before changing the setting.

### Notes:

- When recording in extreme low-light conditions, we recommend the use of a Canon Speedlite (p. 45) or Video Light (available as optional accessories, see page 14).
- The Tv values are reset if you turn the power off or change the recording program. If you use the STANDBY lever, however, the camera remembers your chosen values.

## Giving priority to the aperture (aperture-priority: Av)

Use this program to select the aperture (iris diameter) to give you maximum control over the depth of field. A large F number (a small aperture) gives a greater depth of field.

You can choose 12 F numbers between  $f/1.6$  and  $f/11$ . If you try to set an F number that is too high or too low for the shooting conditions, the indicator flashes in the display. In this case, increase or decrease the setting until the flashing stops.

Av



The camera sets all the other values necessary to give the correct exposure.

When you turn the program selector to Av, the current shutter speed is shown in the display. Select your desired F number by turning the EXPOSURE dial.

- Under very bright conditions when you have set the F number to  $f/11$ , blurring of the image may occur. Check the image in the display while setting the aperture.

### Notes:

- The  $f/1.6$ – $f/2.4$  Av values are not available when you zoom in near the telephoto end.
- The Av values are reset if you turn the power off or change the recording program. If you use the STANDBY lever, however, the camera remembers your chosen values.

## Manual (See also p. 55)

Select this program for total creative freedom when operating the camcorder. You can set aperture and shutter speeds completely independently to give you exactly the exposure you require.

M

There are 27 shutter speed settings, between  $1/60$  and  $1/15000$  of a second; 23 aperture values, between  $f/1.6$  and  $f/11$  (you can also close the iris); and 5 gain values, between 0dB and +12dB.

## Sand & Snow

Use this program in places where the background is so bright that the subject appears underexposed in the display — a sunny beach or ski resort, for example. You may notice some shudder when recording moving subjects.



## Spotlight

This program is designed for recording spotlit scenes, such as on a stage. The exposure is automatically adjusted for glare-free recordings of subjects lit by a concentrated light source.



## Using Digital Effects

Add the camera's digital effects during recording for more interesting productions. Except for the fade trigger, all digital effects can be used for both still photos and video, and sound is recorded normally.

E

### Fade Trigger

When you start recording, the scene gradually fades in from a black screen. When you stop recording, it gradually fades out.

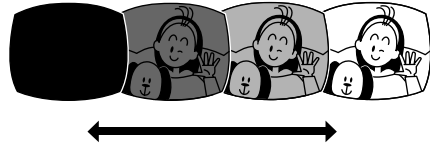

Set the fade trigger each time you wish to use it (both before you fade in and again before you fade out).

FADE-T is shown constantly in the display when it is ready for use.

### Black and White

Records the image in black and white.

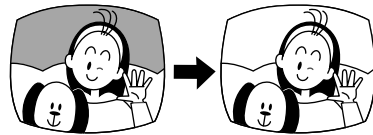

### Slim

The image appears compressed horizontally.

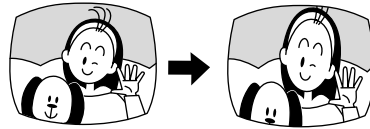

### Stretch

The image appears compressed vertically.

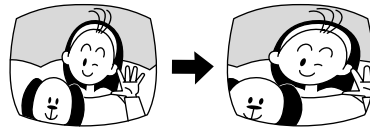

### Strobe

This effect converts on-screen action to a series of still images, giving an effect similar to slow-motion.

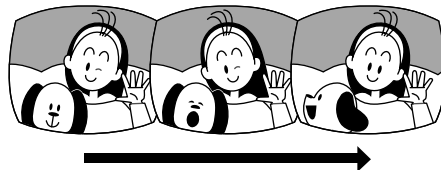

## Operating the digital effects

1. Set the camera to record pause mode.
2. Set the program selector to any mode other than  Easy Recording.
3. Open the camera menu and select D.EFFECT.
4. Select your desired effect and close the menu.
  - Your chosen effect flashes in the display.
  - Select OFF to deselect all effects.
5. Press the D.E. ON/OFF button.
  - If you have chosen FADE-T, FADE-T stops flashing.
  - If you have chosen any other effect, it will take effect on the screen.
6. Press the start/stop button to start/stop recording.
  - If you have chosen FADE-T, the scene fades in from black (together with the sound) and FADE-T starts to flash again in the display.
  - If you wish to use the fade trigger again, press the D.E. ON/OFF button. If not, you can select a different digital effect, or turn the digital effects off completely through D.EFFECT in the camera menu.

### Notes:

- You cannot use fade trigger while taking a still picture.
- You cannot select a different digital effect while the fade trigger is still turned on.
- You can turn the fade trigger off before you use it by pressing the D.E. ON/OFF button again.
- You are unable to use digital effects in the Easy Recording program.
- The camcorder will remember your D.E. ON/OFF button setting even if you change the program selector (to any program other than Easy Recording).
- If you slide the POWER switch to OFF or turn the standby lever to LOCK, digital effects will be turned off.

## 16:9 (Widescreen TV recording)

Produces images in the 16:9 format for playback on widescreen TVs.

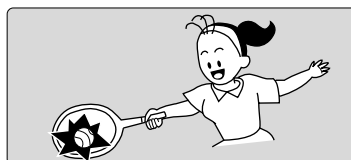
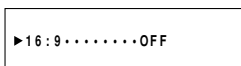

1. Select 16:9 from the camera menu and turn the effect ON/OFF.
2. Press the MENU button once more to close the menu.

### Notes:

- “16:9” is shown in the display when you switch the 16:9 effect on.
- You cannot use the 16:9 digital effect with the Easy Recording program.
- If you play back a recording made for 16:9 on a normal TV screen, the image will appear to be vertically “squashed” (compressed).

# Audio Recording

## Selecting the audio mode

The GL1 can record sound in two audio modes:

- 16-bit (48 kHz, 2 channel) for the highest sound quality
- 12-bit (32 kHz, 2 from 4 channels) for recording on two channels (stereo 1), leaving two channels (stereo 2) free for you to add new sound at a later date.



1. To switch the mode, open the camera or VCR menu and select **AUDIO MODE**.
2. Select a mode, and close the menu.
  - The name of your chosen mode is displayed for 4 seconds.

**Note:**

- For audio output details, including how to play back a tape that has new sound on stereo 2, see page 86.

## Wind screen

The camera has an automatic wind screen to prevent wind noise from interfering with the sound track. Make sure it's off when you want the microphone to be as sensitive as possible. Use the wind screen when recording in windy places such as the beach or near buildings.

The wind screen does not operate with an external microphone. The WIND SCREEN menu options disappear (“— — —”) when an external microphone is connected to the MIC terminal.



1. Open the camera or VCR menu and point the arrow at **WIND SCREEN**.
2. Select the **ON** setting and close the menu.
  - WS **ON** is shown in the display.

## Setting the Self-Timer

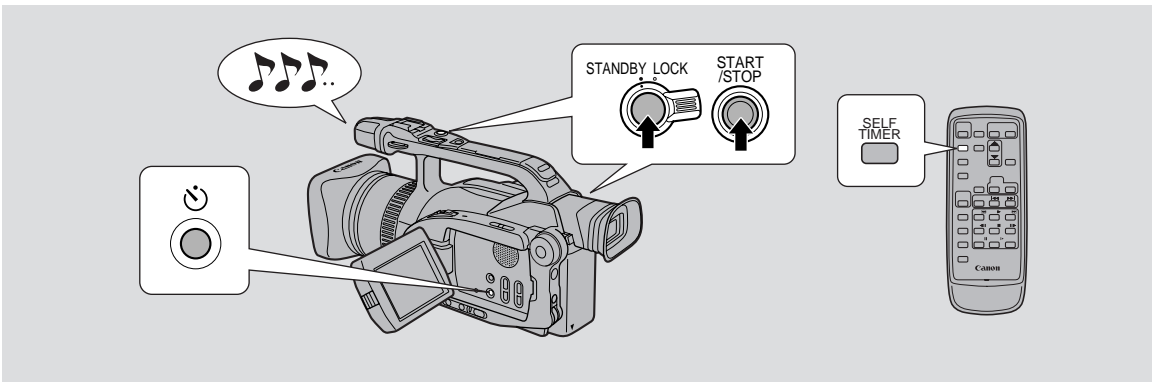

E



This is useful when you want to include yourself in the picture when recording.

1. **Set the camera to record pause mode.**
2. **Press the self-timer  button on the body of the camera**  
or  
**the SELF TIMER button on the wireless controller.**
  - SELF T. appears in the display.
  - To have the subject monitor recording, rotate the LCD panel 180° (p. 26).
3. **Press the start/stop button.**
  - The camera starts to record after a 10-second countdown period (or after two seconds when you use the wireless controller). The time remaining counts down in the display (e.g. “5 SEC”).
  - SELF T. disappears from the display when recording begins.
  - The tally lamp starts flashing.
4. **Press the start/stop button to end recording.**
  - After recording a still picture for about six seconds, the camera automatically goes into record pause mode.

### Notes:

- Initially the tally lamp flashes once a second, then just before recording it starts flashing more quickly for a few seconds before the camera starts to record.
- If you have the beep turned on, it sounds each time the tally lamp flashes before recording.
- To cancel the self-timer before the countdown has begun, press the self-timer button again.
- To cancel the self-timer once the countdown has begun, press start/stop or the self-timer button on the wireless controller or the body of the camera.
- When taking a still photo, set the self-timer and press a PHOTO button on the camera body or the wireless controller. The camera automatically adjusts the focus two seconds before the countdown is complete. The  mark flashes white then turns green after the focus and exposure are set. If you are using the wireless controller, the  mark starts flashing immediately after you press the photo button. The camcorder takes the picture for approximately six seconds.

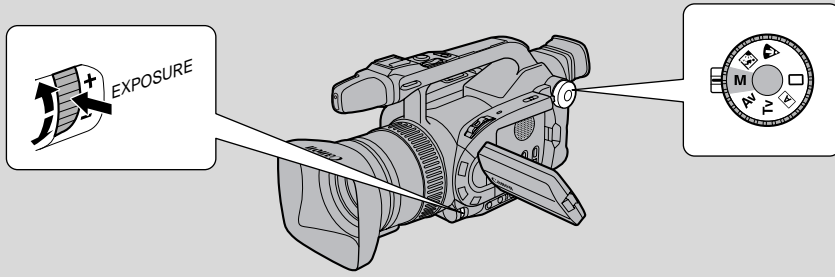

- Turn the program selector to the **Manual recording program**.
- Press the **EXPOSURE** dial in.
  - An arrow appears next to the shutter speed value.
- Turn the **EXPOSURE** dial to **increase or decrease the shutter speed**.
  - You can choose 27 shutter speeds between 1/60 and 1/15000 of a second.
  - See "About the shutter speed" (p. 56).
- Press the **EXPOSURE** dial in **again**.
  - The arrow moves next to the F number.
- Turn the **EXPOSURE** dial to **open or close the iris**.
  - Choose among 23 F numbers between f/1.6 and f/11, and CLOSE to shut the iris completely.
  - See "About the iris" (p. 56).
- Press the **EXPOSURE** dial in **once more**.
  - The arrow moves next to the gain value.
- Turn the **EXPOSURE** dial to **increase or decrease the gain**.
  - Set the gain to 0dB, +3dB, +6dB, +9dB or +12dB.
  - See "About the gain" (p. 56).

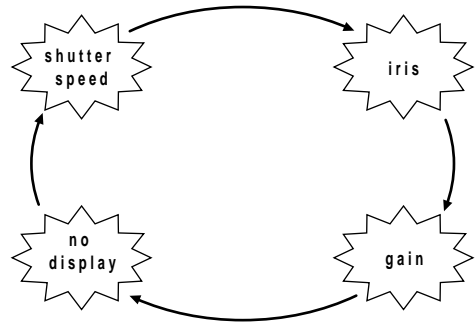

**Notes:**

- The shutter speed, F number and gain values are all reset if you slide the POWER switch to OFF. If you use the standby lever, however, the camcorder remembers your chosen values.
- A bar showing the standard exposure appears in the display.
- You can also vary the exposure manually in the Auto, Tv and Av modes, but you must first lock the exposure to adjust the shutter speed and iris.

## ● About the shutter speed

Turn the EXPOSURE dial toward + for a slower shutter speed or – for a faster shutter speed.

Available shutter speeds:

1/60 sec ↔ 1/75 sec ↔ 1/90 sec ↔ 1/100 sec ↔ 1/120 sec ↔ 1/150 sec ↔ 1/180 sec  
 1/500 sec ↔ 1/420 sec ↔ 1/360 sec ↔ 1/300 sec ↔ 1/250 sec ↔ 1/210 sec  
 1/600 sec ↔ 1/720 sec ↔ 1/840 sec ↔ 1/1000 sec ↔ 1/1200 sec ↔ 1/1400 sec  
 1/4000 sec ↔ 1/3000 sec ↔ 1/2600 sec ↔ 1/2300 sec ↔ 1/2000 sec ↔ 1/1700 sec  
 1/8000 sec ↔ 1/15000 sec

## ● About the iris

Turn the EXPOSURE dial toward + for a shorter depth of field or – for a greater depth of field.

Available F numbers:

F1.6\* ↔ F1.8\* ↔ F2\* ↔ F2.2\* ↔ F2.4\* ↔ F2.6\* ↔ F2.8 ↔ F3.2  
 F6.2 ↔ F5.6 ↔ F5.2 ↔ F4.8 ↔ F4.4 ↔ F4 ↔ F3.7 ↔ F3.4  
 F6.7 ↔ F7.3 ↔ F8 ↔ F8.7 ↔ F9.5 ↔ F10 ↔ F11 ↔ CLOSE

\* These values not available when you zoom in near the telephoto end.

- Under very bright conditions when you have set the F number to f/11, blurring of the image may occur. Check the image in the viewfinder while setting the aperture.

## ● About the gain

Turn the EXPOSURE dial toward + to increase the gain or – to lower it.

Available gain values: 0dB, +3dB, +6dB, +9dB, +12dB



## Exposure lock/adjustment

E

### ● Exposure lock

Lock the exposure at the current level in order to control the brightness of the image.

To lock the exposure, press the EXPOSURE dial in once. Press it again to return to the automatically set exposure level.

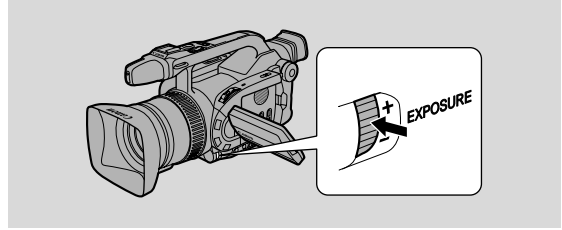

#### Notes:

- You cannot lock the exposure in the □ (Easy Recording) or M (Manual) recording programs.
- The standard exposure level depends on which recording program you have selected, but the shutter normally operates at 1/60 of a second.
- The brightness of the subject may change if you zoom during exposure lock.

If you slide the POWER switch to OFF or the standby lever to LOCK, the camcorder resets to auto exposure.

### ● Exposure adjustment

When the exposure is locked, you can adjust it manually, making the picture brighter or darker in order to deal with difficult lighting conditions, or to manipulate the mood of the scene. The camera's iris can be manually set to any position from fully closed to fully open.

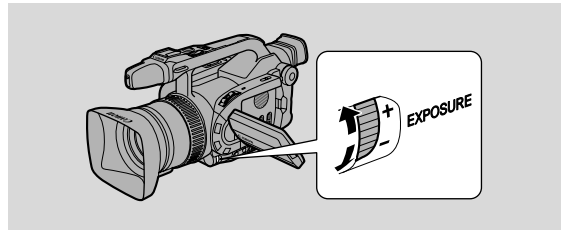

To make the recorded image brighter, turn the EXPOSURE dial upwards (to a maximum of +11). This may be necessary if the background is very bright, or if the subject is lit from behind.

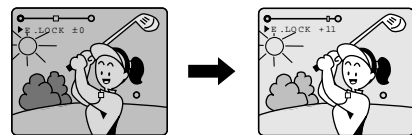

To make the recorded image darker, turn the EXPOSURE dial downwards (to a minimum of -11). This may be necessary if the background is very dark, or if the subject is spotlighted.

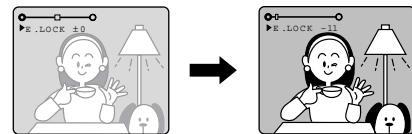

## Adjusting the Focus

E

The camera can focus automatically. All you have to do is point it, and whatever is in the center of the display will usually be in sharp focus. If it does not seem to be focusing well, it may be because the subject is not suitable for autofocus (page 93). Also, if you attach a filter other than UV or ND, the autofocus may not work as effectively.

### Temporary focus override

You can adjust the focus temporarily without turning autofocus off. Turn the lens's focus ring counterclockwise to set the focus farther away from the camcorder or clockwise to set the focus closer to the camcorder. Autofocus will resume as soon as you take your hand away from the focusing ring. This is convenient when shooting through glass.

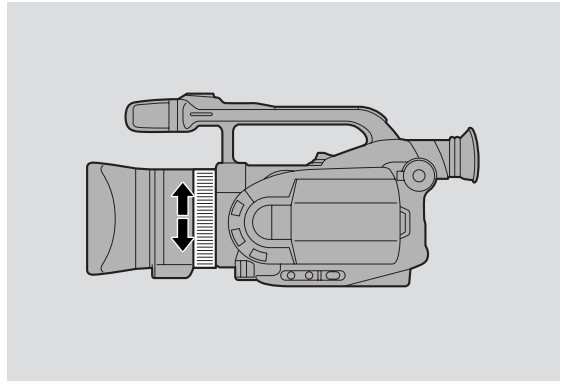

### Manual focus

1. Turn the program selector to any recording program other than  (Easy Recording) program.
2. Push the FOCUS A/M button so that MF appears in the display.
3. Using the zoom lever, zoom all the way in to the telephoto end.
4. Rotate the focusing ring to adjust the focus.
5. Use the zoom lever to reframe the subject.
  - To resume autofocus, press the FOCUS A/M button again.

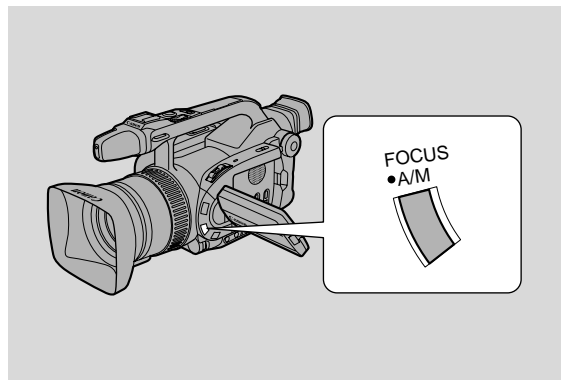

#### Notes:

- The picture in the LCD screen may appear out of focus when shooting in dark conditions.
- When zooming during manual focus, zoom out wide only after setting the focus at the telephoto end. The focus may be thrown off if you zoom into telephoto after setting the focus at the wide angle end. Autofocus is recommended for zooming in to telephoto from the wide end.
- If you slide the POWER switch to OFF or the standby lever to LOCK, the camcorder resets to auto focus.

## Using AE Shift

By controlling the level of the automatic exposure (AE) function, you can lighten or darken the image slightly. This allows you to compensate for backlit, overexposed scenes.

E

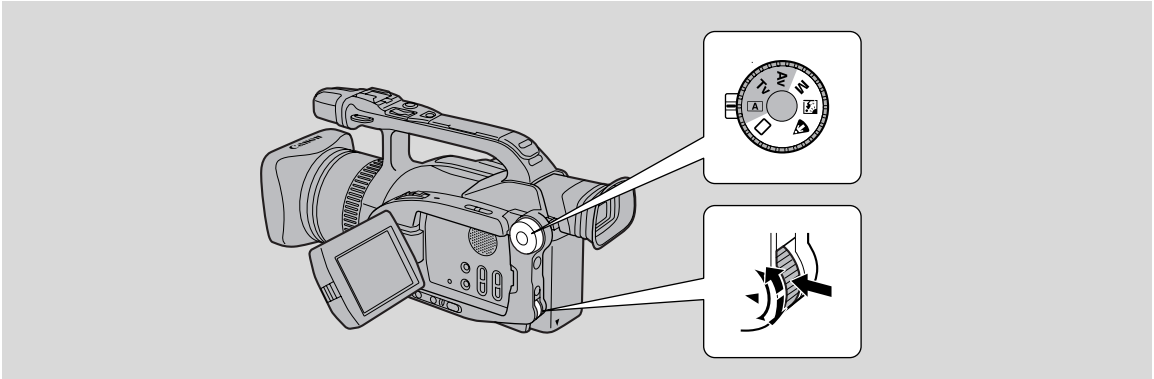

1. Turn the program selector to the Auto, Tv or Av recording program.
2. Open the camera menu and select AE SHIFT.
3. Turn the menu dial to choose your desired level.
  - Levels are from  $-2$  to  $+2$ , in  $0.25$  intervals (excluding  $-1.75$  and  $+1.75$ ).
  - The higher the setting, the brighter the image.
4. Close the menu.

**Note:**

- AE shift does not function in the Easy, Manual, Sand & Snow or Spotlight Recording programs.

## Adjusting Camera Sharpness

Change the sharpness level before shooting for more creative videos.

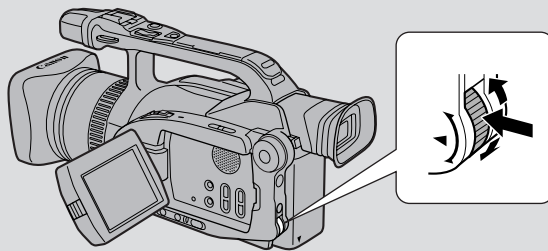

**MENU**  
(see p. 34)

▶ C. SHARPNESS · - [ ] +

1. Select **C.SHARPNESS** from the camera menu.
2. Set your desired sharpness level.
  - Adjust toward + for a sharper picture, and toward – to soften the contour.
  - CP (custom preset) appears in the display.

## Adjusting Color Phase

Change the color phase level before shooting for more creative videos.

E

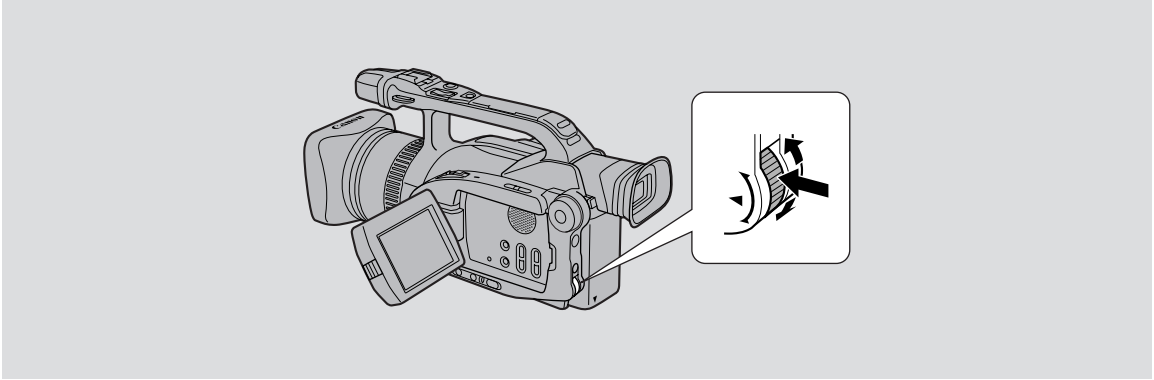

**MENU**  
(see p. 34)

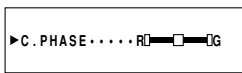

1. Select **C. (color) PHASE** from the camera menu.
2. Set your desired color level.
  - Adjust toward R for a redder picture, and toward G for a greener picture.
  - CP (custom preset) appears in the display.

## Using the Zebra Pattern

E

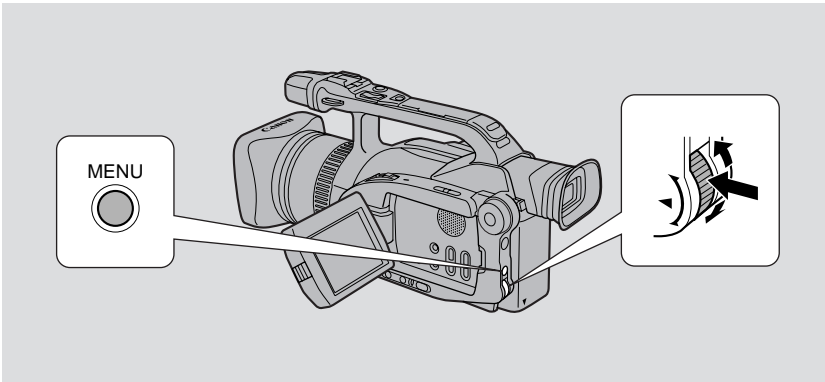

The zebra pattern is a series of diagonal stripes that appear in the display to highlight areas of overexposure. Use as a guide to setting the aperture (iris) and shutter speed.



1. Open the camera menu and select **ZEBRA**.
2. Select the **ON** setting and close the menu.

**Note:**

- The camera does not record the zebra pattern, it is only shown in the display.

## Adjusting the White Balance

The camera's auto white balance system compensates for a wide range of lighting conditions. Although slight variations are unavoidable, colors will appear natural in virtually every situation.

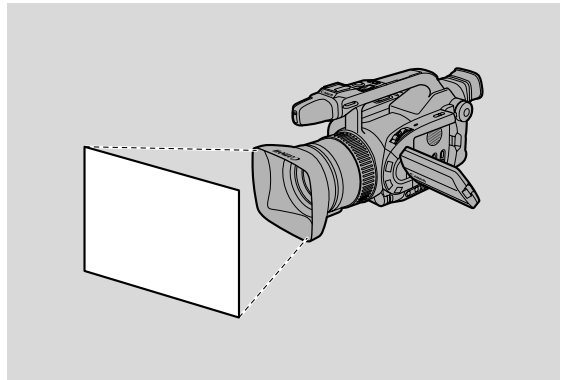

In some cases, you will get better results by setting the white balance yourself, or using one of the two preset modes:

- ☺ Indoor Mode
  - Under halogen or studio/video lighting
  - Subject is of one dominant color
  - Close ups
- ☀ Outdoor mode
  - In daylight, especially for close-ups and where the subject is of one dominant color



E

### Setting the white balance

1. Turn the program selector to any recording program (except the  Easy Recording program).
2. a) For auto white balance, indoor lighting or outdoor lighting, press the **WHITE BALANCE SELECT** button.
  - ☺/☀ appears in the display when you set the white balance to the indoor/outdoor modes.
- b) To set the white balance manually:
  - ① Point the camera at a white object (such as a sheet of paper) and zoom in until it fills the display.
  - ② Press the **WHITE BALANCE SELECT** button.
    -  appears in the display.
  - ③ Press the **WHITE BALANCE**  set button.
    -  flashes quickly in the display and then remains lit, to show that the camera has set the white balance.
    - Depending on the light source, the flashing may at times change to a slower speed, rather than remaining lit. The result will remain better than with the auto setting, and you can continue recording.

Setting the white balance manually will probably work better than auto white balance when shooting:

Subjects with one dominant color, such as sky, sea or forest



Close-ups





In rapidly changing lighting conditions



In places lit by certain types of fluorescent or mercury vapor lights



**Notes:**

- Turn the digital zoom off (if necessary) to set a more accurate white balance.
- If the lighting conditions change, reset the white balance by first returning to the auto setting, and then reselecting the manual balance.
- Try to record with light from a single source. Correct white balance cannot be obtained for two types of lighting at once.
- You cannot set the white balance manually or use the indoor/outdoor modes when the program selector is set to the  (Easy Recording) program.
- The camera returns to auto white balance when the program selector is turned to  (Easy Recording).
- When you turn the camera on, the white balance returns to auto white balance. If you then press the WHITE BALANCE  set button, the camera will remember your last setting.
- If you shoot with studio/video lighting, use the  (indoor) mode.
- During normal outdoor shooting, setting the camcorder to auto white balance may provide better results.



## Displaying Data Code

A data code, containing the date and time the recording was made and other camera data (shutter speed, exposure and gain settings) is automatically recorded on a special data section of the tape.

E

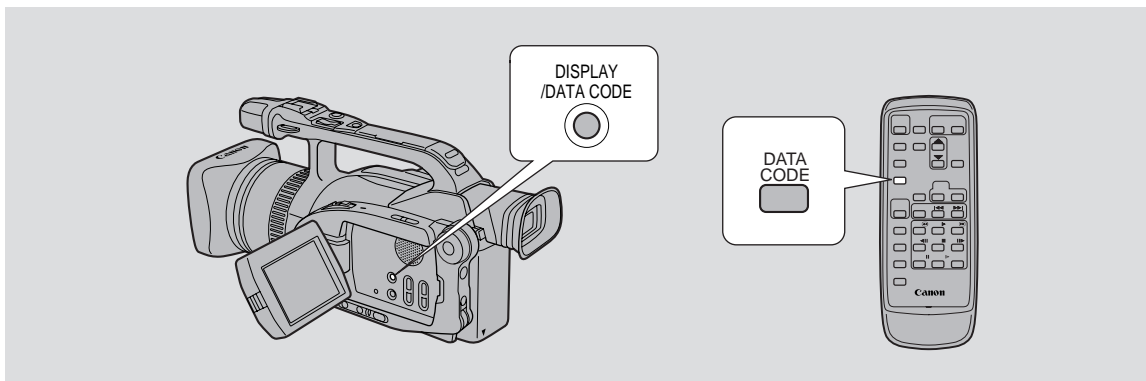

During VCR mode, the data code can be displayed or hidden while the camera is in play, slow, or still mode.

Camera data may be displayed as “— — —” during fast forward, rewind, reverse playback, forward and reverse  $\times 2$  playback.

**Press the DATA CODE button on the wireless controller or the body of the camera.**

- Press it once to display, once more to hide it.

You can also choose which type of data code to display — either the date/time, camera data or both.



▶DATA CODE...DATE/TIME

1. Select **DATA CODE** from the **VCR** menu.
2. Choose between **DATE/TIME**, **CAMERA DATA** and **CAM. & D/T**.
3. Press the **MENU** button once more to close the menu.

**Notes:**

- To avoid accidental recording, make sure that you slide the tab on the cassette so that it exposes the hole (the switch position is usually labeled SAVE or ERASE OFF).
- The data code will read “— — —” in the following situations:
  - During playback of a blank section of tape.
  - If the tape was recorded before entering the date and time in the camera’s memory.
  - If the tape was recorded on a camera without a data code function.
  - If noise or tape damage prevents the data code from being read.
- Data code is sometimes not displayed during high speed playback modes.
- If a recording made on GL1 is played back on a different DV camcorder, the data code may not be displayed correctly.
- Contents of data code display may change according to D/TIME SEL. (p. 41) or DATA CODE settings made on the menu.

Setting the “Data Code” Setting “Select Date/Time”	Date/Time	Camera data	Date/Time & Camera data
Date	DEC. 1, 1999	0# F1.6 1/2000	0# F1.6 1/2000 DEC. 1, 1999
Time	10:00:00 AM	0# F1.6 1/2000	0# F1.6 1/2000 10:00:00 AM
Date & Time	10:00 AM DEC. 1, 1999	0# F1.6 1/2000	0# F1.6 1/2000 10:00 AM DEC. 1, 1999

- The data code will appear in the display even if DISPLAYS (p. 95) has been set to OFF through the VCR menu.

## Searching the Tape (Photo Search/Date Search)

E

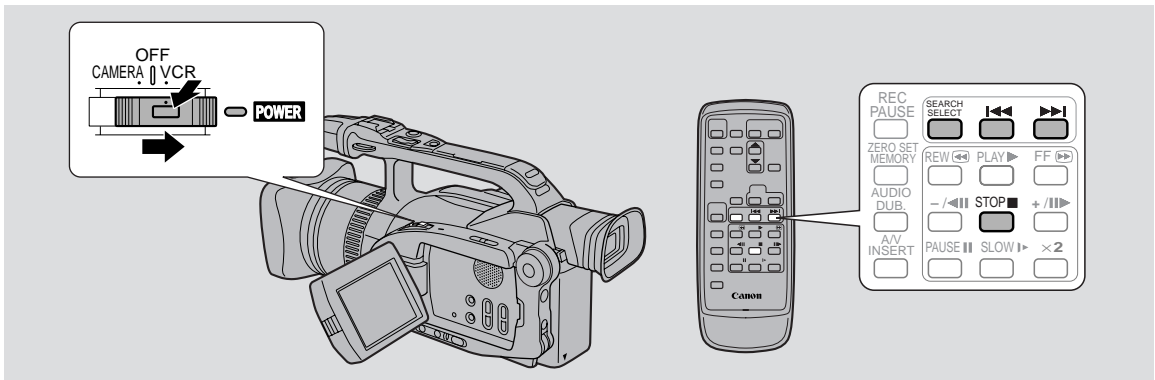

This allows you to move quickly through still pictures recorded anywhere on a tape (photo search) or between different days or areas of recording (date search).

- You can only use this function from the wireless controller.

### 1. Slide the **POWER** switch to **VCR**.

### 2. Press the **SEARCH SELECT** button to choose between photo/date search.

- PHOTO SEARCH or DATE SEARCH is shown in the display for four seconds.

### 3. Press the **◀◀** and **▶▶** buttons to move backwards or forwards through the still pictures or between different days of recording.

- Press once to move to the start of the previous/next still picture or day on the tape.
- You can press more than once to move to the corresponding still picture or day (up to a maximum of ten times), e.g. press the **▶▶** button five times to move forward five still pictures or days.
- PHOTO SEARCH/DATE SEARCH appears in the middle of the display alongside the **◀◀** or **▶▶** mark and number to search through. The date also appears during date search.
- When the camcorder locates the indicated date or still picture, it enters playback or still playback mode.

#### Notes:

- Press **■** (stop) to stop mid-search.
- If you begin a search very close to the start of a recorded still picture during photo search, the camera may skip straight past it.
- When you have set the area for the World Clock, date search also looks for the change in date based on the adjusted time.
- A date/area cannot be identified if the total recording time on that day/area was less than one minute.
- Date search playback may start just before or after the beginning of the located section.
- If the data code is not displayed correctly you will not be able to operate the date search correctly.

## Returning to a Pre-Marked Position

E

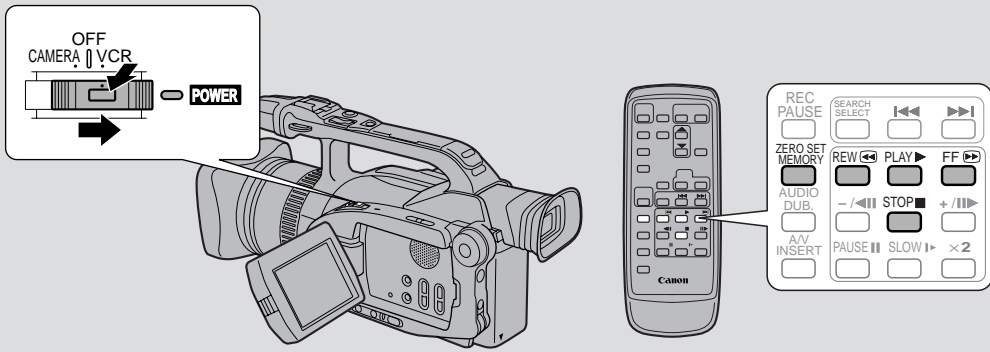

Use the wireless controller to go back to a pre-determined point on a tape following playback.

- 1. Press the ZERO SET MEMORY button on the wireless controller at a point you want to return to later.**
  - The time code is replaced by a tape counter that is set to zero with the **M** indication.
  - Press the ZERO SET MEMORY button once more to cancel the zero set memory.
- 2. When you have finished playback, fast forward or rewind the tape. The tape stops automatically when it reaches the zero set position.**
  - RTN▶▶ or ◀◀RTN appears in the display.
  - The tape counter with **M** indication disappears from the display and the time code reappears.

### Notes:

- The zero set memory may not function correctly where there is a break between recordings on the tape.
- You can also use zero set memory to mark a position on a tape in record pause mode. When you then play back the tape, pressing rewind will take you back to the pre-marked position.
- There may be a slight difference between the timecode and the tape counter readings.
- If you remove the tape while the zero set memory is set, the memory is canceled and the tape counter reverts to timecode.
- The camera remembers your setting even if you slide the POWER switch to OFF.

## The Dubbing Function

The GL1 dubs your pre-recorded scenes onto a tape in your VCR or another camcorder. You can add audio to a tape (audio dubbing, p. 80) or both audio and visual (A/V insert, p. 78). You can also adjust the starting and ending points of the scene (the “cut-in” and “cut-out” points, p. 73). In addition, the GL1 can record from a VCR, TV or analog camcorder (analog line-in, p. 76).

If you connect another Canon digital video camcorder to the camera instead of a VCR, you can use the Dubbing Function for digital-to-digital dubbing, with virtually no generation loss in image and sound quality. However, you cannot set the cut-in and cut-out adjustments using the built-in digital timer (p. 73).

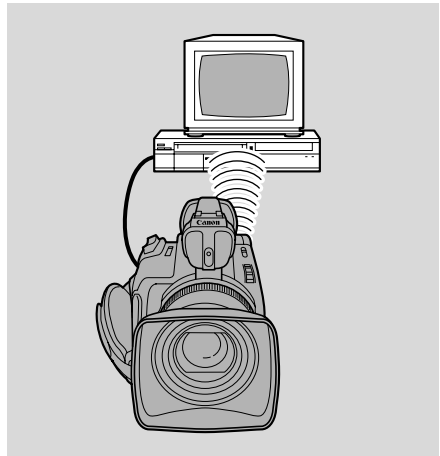

E

### Preparing for Dubbing

#### 1. Connect the camera to the VCR.

- See the “Connections for Playback on a TV Screen” instructions on page 30.

#### 2. Turn the TV on.

- Be sure to set it to the video channel, or set the TV/Video selector to Video.

#### 3. Turn on the VCR and load a blank cassette.

- See your VCR instruction manual.

#### 4. Open the VCR menu and select ➔ DUB MODE.

- When you select DUB MODE all the displayed information is also displayed on the screen of the TV connected your VCR. However, this information will not be recorded onto the tape in the VCR.

### Setting the camera to control your VCR

The camcorder’s Dubbing Function controls your VCR by using the same infra-red signals as the VCR’s remote control.

Make sure the camera is in a spot where it can remotely control your VCR.

#### 1. Check where the remote control sensor is on your VCR using its normal remote control.

#### 2. Place the camera pointing directly at the sensor, not more than 20 inches (50 cm) away.

- Check that the sensor will pick up signals easily from this spot using the VCR’s normal remote control.
- Make sure that the cables and the camera’s shoulder strap do not obstruct the signals.

#### 3. Make sure that the VCR is in record pause mode.

#### 4. Make sure that all other video equipment is turned off to avoid accidental recording.

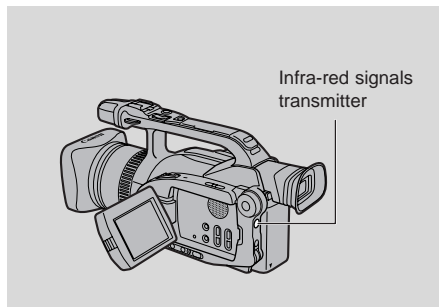

Editing

## Using the Dubbing Function for the First Time

E

When you use the dubbing function for the first time, or with a different VCR, you should set your camcorder to send the correct remote control signals to your VCR.

The camera will not forget this setting unless you change it. Do not alter it again unless you change VCR.

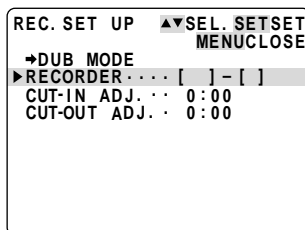

### Preparations & setting up

1. **Make sure that the camera and VCR are set up as in “Preparing for Dubbing,” p. 69 and “Setting the camera to control your VCR,” p. 69.**
2. **Open the VCR menu and select → REC.SET UP.**
  - This takes you to the REC.SET UP menu.
  - It is easiest to view the menu on the TV screen.
3. **Point the arrow to RECORDER and push the menu dial.**
  - You are now unable to use the wireless controller ((Ⓜ) appears in the display).

### Setting RECORDER

Use the chart on the next page to find the RECORDER settings for your brand of VCR. Make sure the camcorder’s infra-red control signals can reach the VCR, and the VCR is in record pause mode. (Ready to record and on pause.)

1. **Set RECORDER to the first setting for your brand of VCR.**

- For example, 7-A if you have a JVC VCR.
- Turn the menu dial to scan the numbers.

```
▶[ 7 ]-[ A ]
```

- Press the menu dial in to select the number corresponding your brand of VCR.

```
▶[ 7 ]-[ A ]
```

- Turn the menu dial to scan the letters. TRANSMITTING DATA appears in the display each time you turn the menu dial.
- After you scan past the last letter for each number, the number advances to the next number.

2. **If the setting is correct, the VCR will start recording automatically.**

- This will occur as long as the camera is pointing at the VCR’s remote sensor while you change the setting.

3. **If the VCR does not start recording, try the next setting.**

- Turn the menu dial (to 7-B in the above example).
- Try each setting in turn until the VCR starts to record.

4. **Depending on the brand of VCR, the signals to start and pause recording may differ. Once the VCR starts to record, check that the setting is right.**

**Set the VCR to record pause again, then press the camera’s start/stop button.**

- The VCR should start to record for a few seconds, and REC appears in the display and on the TV screen. Then it will automatically pause and PAUSE appears in the display and on screen.
- During these REC, PAUSE operations, the VCR records a digital timer, which you will use later for Cut-In and Cut-Out Adjustments. For more accurate adjustments, we recommend that you repeat pressing the start/stop button to record a couple of times.
- If not, then the setting is still not right. Try the next setting.

## RECORDER

The camera's Dubbing Function can remotely control almost all brands and models of VCR. VCR remote control signals vary depending on model and brand. First, choose the right RECORDER setting for your VCR. The number indicates the VCR brand. The letter indicates the set of signals.

Brand	Settings	Brand	Settings	Brand	Settings
Canon	1-A to 1-C	Pioneer	11-A	Thomson	18-A to 18-C
Aiwa	2-A to 2-C	Sanyo	12-A to 12-C	Saba	
Akai	3-A to 3-C	Fisher		Nordmende	
Fujitsu	4-A	Sharp	13-A to 13-C	Ferguson	19-A to 19-C
Funai	5-A	Sony	14-A to 14-F	Grundig	20-A to 20-C
Hitachi	6-A to 6-B	Toshiba	15-A to 15-B	Nokia	21-A to 21-C
JVC	7-A to 7-C	GE	16-A to 16-B	Telefunken	22-A to 22-B
Mitsubishi	8-A to 8-D	RCA		Zenith	23-A
NEC	9-A to 9-D	Magnavox	17-A to 17-B	Samsung	24-A to 24-B
Panasonic	10-A to 10-G	Philips	18-A to 18-C	GoldStar	25-A
Blaupunkt		Seleco			
Quasar		Rex			

as of March 1999

### Notes:

- Once you find the correct setting, remember this and do not change it unless you change VCRs.
- See p. 73 for details of the “cut-in” and “cut-out” adjustments.
- If you try all the numbers and letters, but the VCR has still not started to record:
  - Check the VCR is ready to record, and on pause.
  - Check the VCR can receive signals from where the camera is, and that nothing is blocking the signals.
  - Go back and try to set it again.

- If your brand of VCR is not on the chart, or you cannot find the correct setting, try all the numbers with the menu dial until the VCR starts to record.
- It is unlikely, but you may have a VCR the Dubbing Function cannot control. If so use the Simple Editing method on p. 74.

## Dubbing to a VCR

- 1. Make sure you are in DUB MODE (see p. 69).**
  - WIND THE TAPES AND PAUSE → SET appears in the display.
- 2. Set the tape in the VCR to the point where you want to start recording, set it to record pause mode.**

**Set the tape in the camera to the point where you want to start dubbing, set the camera to playback pause mode.**

  - You can use the ◀◀, ▶▶, ▶, || and ■ buttons or special playback functions in the same way as in playback mode.
- 3. Press the menu dial in.**
  - START ..... PRESS ▶ TO START DUB appears in the DUB MODE screen.
  - Now you are unable to use the wireless controller.
- 4. Press ▶ on the body of the camera.**
  - Recording starts.
  - NOW DUBBING CUT-OUT PUSH || appears in the display.
- 5. When you reach the end of the scene you want to record, press || on the body of the camera.**
  - The camera returns to playback pause mode and the VCR automatically switches to record pause mode.
  - When you finish dubbing, press the MENU button. The camera returns to VCR mode.
  - If you set the zero set memory at the position on the tape where you want to stop dubbing, every time you return to that point, the camera will cancel its dubbing and enter playback pause mode, and the VCR will enter record pause mode.

### Note:

- To cancel during dubbing, push ■ on the body of the camera.



# Cut-In and Cut-Out Adjustments

## Setting the Cut-In and Cut-Out Adjustments

The point where a scene starts is called the “cut-in” point, and the point where it ends is called the “cut-out” point.

Some VCR models take a second or more to actually start recording after they receive the command signal. If this happens you could lose the beginning of the scene. CUT-IN ADJ. prevents this by sending the command a little early.

Similarly, some models take some time to react to the command to stop recording. Some models also rewind slightly after they stop. You could therefore record more than you wanted, or lose the end of the scene. CUT-OUT ADJ. prevents this, by sending the command a little early or late.

If you have these problems with your VCR, reset these adjustments.

Use the REC.SET UP menu to set the “cut-in” and “cut-out” adjustments.

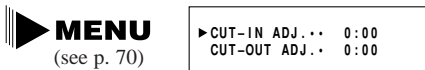

- 1. Open the REC.SET UP menu and point the arrow at CUT-IN ADJ.**
  - Point it at “CUT-OUT ADJ.” to set the cut out adjustment.
- 2. Adjust the setting.**
  - CUT-IN ADJ. can be set up to five seconds early. (-5:00 to 0:00)
  - CUT-OUT ADJ. can be set from one second early to five seconds late. (-1:00 to +5:00)
  - This can be set to an accuracy of one frame.

## How to calculate the best adjustment for the “cut-in” and “cut-out” points

Use the tape on which you recorded the digital timer in “Setting RECORDER” to calculate the cut-in and cut-out adjustment values.

- 1. Rewind the tape in the VCR and start playback to play back the recorded digital timer.**
  - Look at the time the CUT-OUT timer stops and CUT-IN timer starts. These times are what the CUT-OUT ADJ. and CUT-IN ADJ. settings should be.
  - For maximum accuracy, take an average of at least three readings.
  - If your VCR has a frame advance function or a jog dial, you can use it to find the precise starting times more conveniently.
- 2. Set the CUT-OUT ADJ. and CUT-IN ADJ. settings to the center of the three readings.**

**Note:**

- The camcorder will remember the cut-in and cut-out adjustment settings until you change them.

## Simple Editing to a VCR

E

If you cannot find the appropriate remote control setting for the camcorder to control your VCR, you still can edit a tape to the VCR as follows.

### Preparations

- 1. Connect the camera to the VCR.**
  - See “Connections for Playback on a TV Screen” on p. 30.
- 2. Prepare the TV and VCR.**
  - Turn on the TV and set it to the video channel, or set the TV/VIDEO selector to VIDEO.
  - Turn on the VCR, and set its input selector to LINE. Load a blank cassette, and put the VCR in record pause mode.
  - See your TV and VCR instruction manuals for details.
- 3. Turn the camera’s POWER switch to VCR, and load your recorded cassette.**

### Basic editing

- 1. Find a point on your recorded cassette slightly before the section you want to copy.**
- 2. Start to play it back while you monitor the picture on the TV.**
- 3. Start recording on the VCR as soon as the section you want to copy appears on the screen.**
- 4. Pause the VCR at the end of the section you want to copy, then stop playback on the camera.**
- 5. Repeat steps 1 to 4 until your edited recording is complete.**

#### Note:

- The quality of the edited tape will be slightly lower than that of the original.

### REMOTE terminal

The REMOTE terminal allows you to connect the camera to equipment. Some buttons on editing equipment may operate differently from those on the camera.

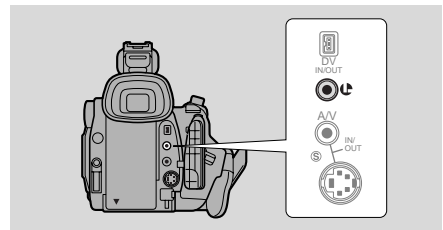

#### Notes:

- (LANC) is a trademark. It stands for Local Application Control Bus System.
- We cannot guarantee the results when connecting to equipment not bearing the LANC symbol.

# Dubbing with Digital Video Equipment

## DV terminal/connections

E

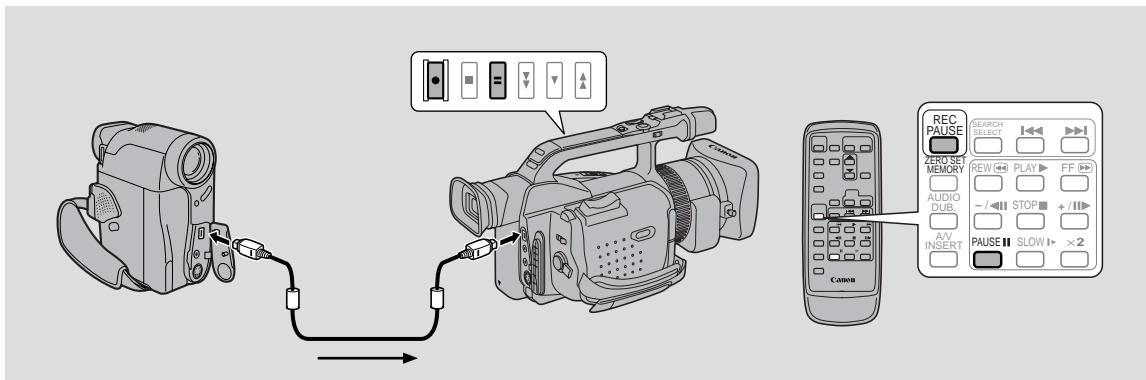

Digital video equipment fitted with this terminal lets you edit, copy and transfer data digitally, with virtually no generation loss in image and sound quality. The DV terminal is for both line-in and line-out, since a single DV cable can handle data in both directions.

- If another Canon digital video camcorder is connected, the Dubbing Function can be used for digital-to-digital dubbing (i.e. with virtually no generation loss in image quality).
- If a VCR is connected and an anomalous signal is sent from the VCR, the images recorded on the tape may also be anomalous (although it may not appear so on the TV image), or not recorded at all.
- You may not be able to dub tapes recorded with the copyright protective signal.

Use a Canon CV-150F DV cable (optional) to connect two digital devices together. When you are recording from the GL1, make sure you connect the cable to the GL1 before connecting the other end of the cable to the recording device. When you are recording to the GL1, slide the POWER switch to VCR and press its ● (record) and ■ (pause) buttons down simultaneously, or press the REC PAUSE button on the wireless controller (“DV IN” appears in the display when you press “play” on the playback device). Then press its pause button to start/pause recording.

- The image displayed by the camcorder that is being recorded to (for example on its LCD screen, an attached TV, or in its viewfinder) may become distorted during digital dubbing. The actual recording on the tape, however, is not affected.
- Blanks between recordings on the playback tape are recorded as anomalous images on the tape that is being recorded to.
- Do not turn the power off when operating either camcorder with the DV cable connected.

## Copyright signal

Certain pre-recorded software tapes are copyright protected. If you try to play back such a cassette, “COPYRIGHT PROTECTED PLAYBACK IS RESTRICTED” appears in the display for a few seconds and then the camera displays a blank blue screen; you cannot view the contents of the cassette.

If you try to record from such a tape via the digital cable “COPYRIGHT PROTECTED DUBBING RESTRICTED” appears in the display; you cannot record the contents of the tape.

## Recording from a VCR, TV or Other Camcorder (Analog Line-in)

E

You can record a TV program or a video played on your VCR or analog camcorder (digital camcorders, see p. 75) onto a tape in the GL1, if the TV or other device has audio/video outputs.

- If an anomalous signal is sent from the TV or VCR, the images recorded on the tape may also be anomalous (although it may not appear so on the TV image), or not recorded at all.
- You may not be able to dub tapes recorded with the copyright protective signal.
- The GL1 cannot record or play back tapes with closed captioning.

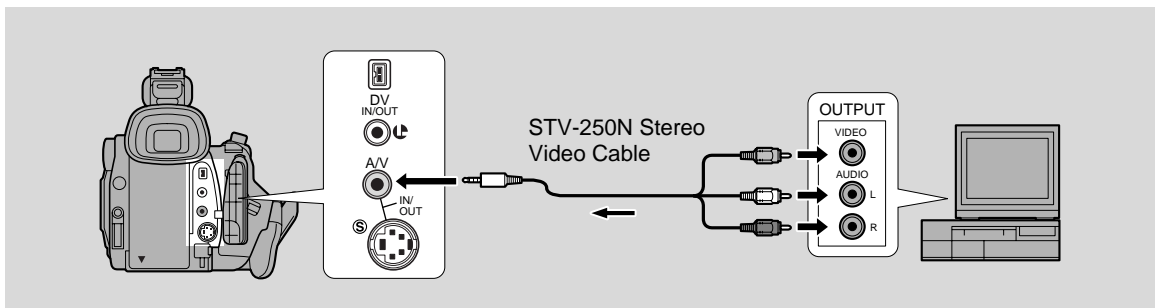
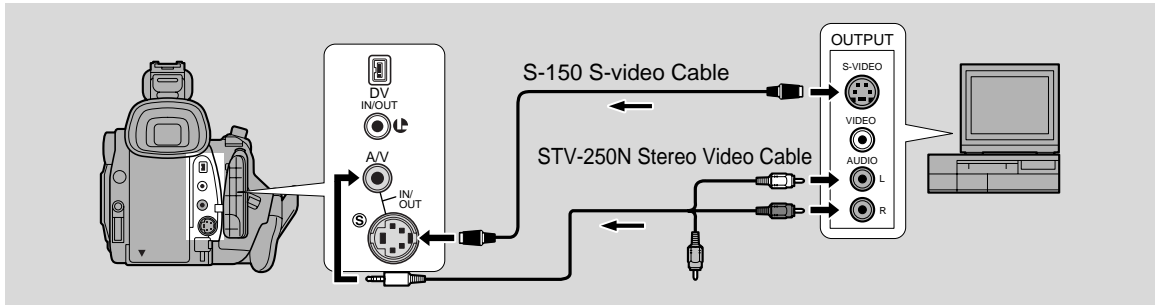

### Preparations

- 1. Connect the camera to the VCR, TV or other camcorder.**
  - See “Connections for Playback on a TV Screen” on p. 30.
- 2. Prepare the TV and VCR.**
  - Turn on the TV and set it to the video channel, or set the TV/VIDEO selector to VIDEO.
  - Turn on the VCR. Load your recorded cassette, and put the VCR in playback pause mode.
  - See your TV and VCR instruction manuals for details.
- 3. Slide the camera’s POWER switch to VCR, and load a blank cassette.**

1. Find a point on your recorded cassette slightly before the section you want to copy.
2. Start to play it back while you monitor the picture on the TV.
3. Press the ● and ■ buttons on the body of the GL1 simultaneously or REC PAUSE on the wireless controller.
  - S-video and A/V IN/OUT terminals automatically work as input terminals.
4. Press the pause button.
  - Recording starts.
5. When you get to the point where you want to stop recording, press the stop button or the pause button.
  - Recording stops.
6. Repeat steps 1 to 5 until your edited recording is complete.

### Notes:

- You can monitor the picture in the viewfinder or LCD.
- If your VCR or TV is a monaural type, connect only the white plug for audio on both the camcorder and the VCR or TV.



## Recording Over Existing Scenes (A/V Insert Editing)

E

You can insert new scenes from your VCR or other camcorder onto your pre-recorded tape using the GL1's analog line-in or DV in terminals. Original video and audio will be replaced with the new video and audio.

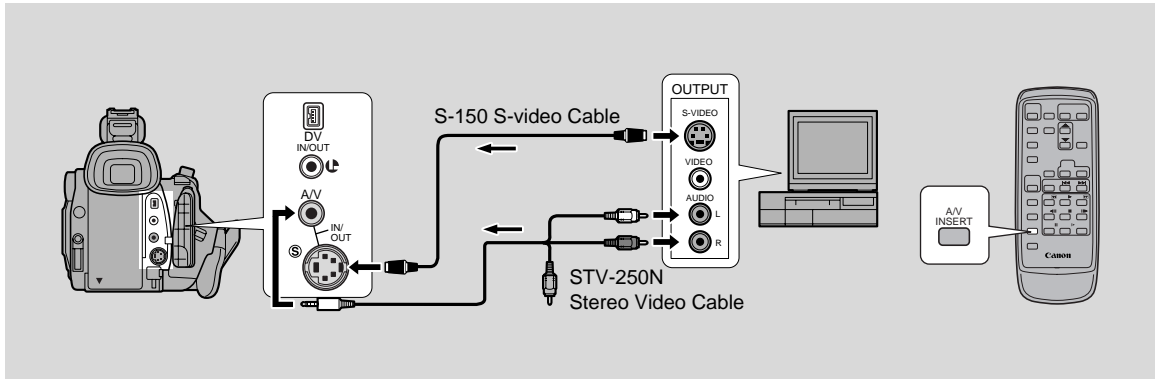

### The tape in the camera:

When using the GL1's A/V insert function, only record to tapes recorded in SP mode with continuously recorded time codes.

If there are non-recorded portions or portions recorded in LP mode on the tape, recording may be interrupted or you may not be able to insert A/V correctly.

### The playback tape:

Use only tapes without non-recorded portions.

If there are non-recorded portions or changes in the recording mode, you may not be able to insert A/V correctly.

You cannot insert A/V in the following cases:

- The playback tape has been poorly recorded.
- During special playback: fast forward playback, rewind playback or slow playback etc.

### TV:

You cannot insert A/V from a TV program with anomalous synchronized signals, such as when the program itself received poor signals.

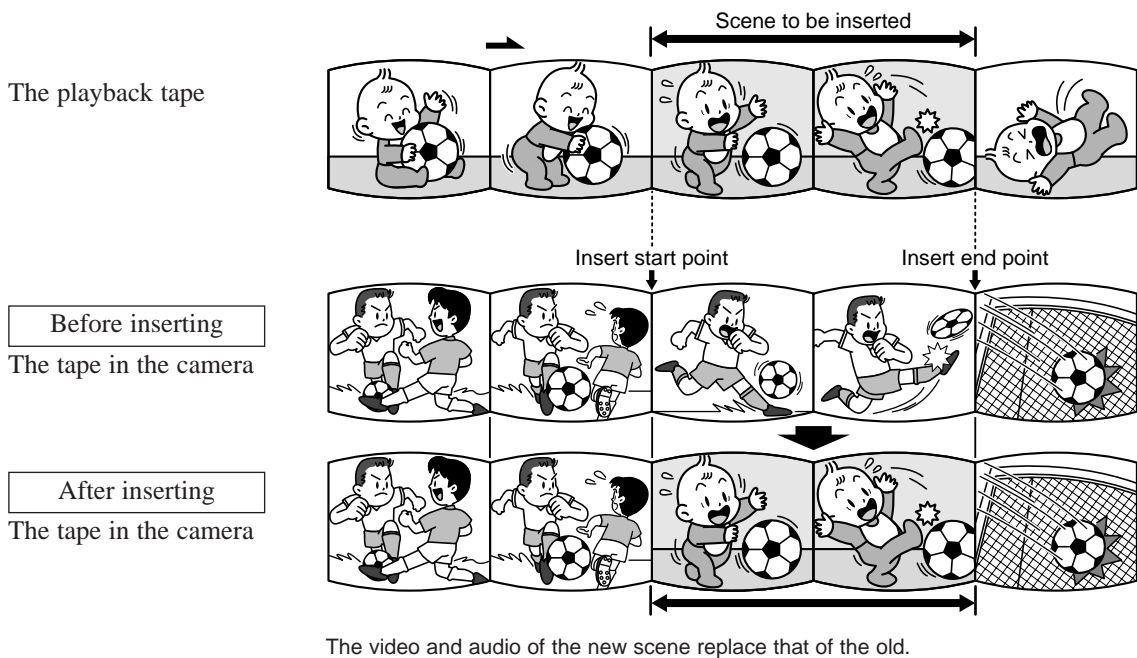

1. **Connect the camera to the VCR (p. 30), load recorded tapes into both the camcorder and VCR.**
  - Make sure the REC/SAVE tab on the tape has been slid to REC (closed position).
2. **Slide the POWER switch to VCR.**
3. **On the VCR, locate a point three seconds before the scene to be inserted (to ensure a stable picture). Set the VCR to playback pause mode.**
4. **On the camera, locate the recording start point. Set the camera to playback pause mode.**
  - You can use the camera's ◀◀, ▶▶, ▶, || and ■ buttons or special playback functions just as when in playback mode.
5. **Press the A/V INSERT button on the wireless controller.**
  - A/V INSERT and ●|| appear in the display.
6. **On the VCR, play back the tape.**
7. **When you get to the starting point of the scene to be inserted, push the pause button on the camera.**
  - A/V insert starts.
  - ●|| changes to ●.
8. **When you get to the point where you want to stop inserting, press the stop button of the camera.**
  - Inserting stops and A/V INSERT disappears from the display. The camera returns to stop mode.
  - If instead of pressing ■ (STOP) you press || (PAUSE), the camera returns to the A/V insert pause mode.
  - If you set the zero set memory at the position on the tape where you want to stop inserting, every time you return to that point, the camera will cancel its A/V inserting and enter stop mode.
9. **Press the stop button of the VCR.**

## Audio Dubbing

E

You can add sound to the original sound on a prerecorded tape from audio products (AUDIO IN) or with the internal or an external microphone (MIC IN). Audio added through audio dubbing is dubbed onto Stereo 2. The original sound will not be erased. For best results, add sound to tapes that have been recorded with this camera in SP mode with 12-bit sound. If there are non-recorded portions on the tape, or portions recorded in LP mode, or with 16-bit or 12-bit, 4-channel sound, dubbing may be interrupted or you may not be able to dub audio correctly. You cannot dub audio onto a tape recorded with 12-bit and 16-bit sound intermingled. If your tape hasn't been recorded with 12-bit sound, we recommend dubbing your original tape onto a blank tape using the GL1's analog line-in function, then dubbing audio onto the new tape. Make absolutely sure to set the audio mode of the new tape to 12-bit and the recording mode to SP.

### To connect other audio equipment:

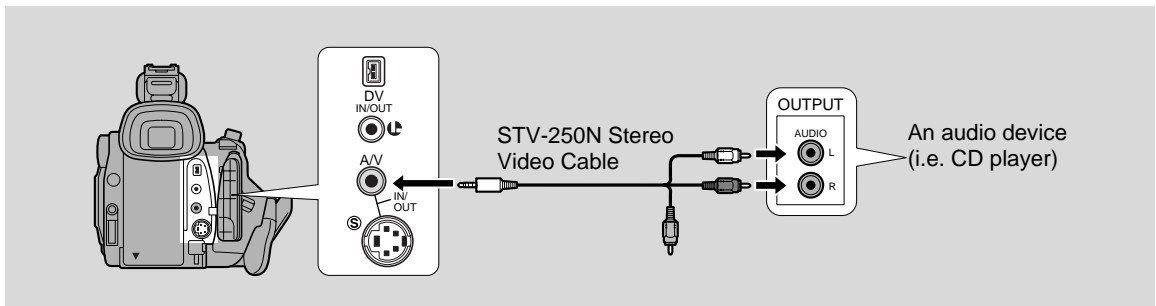

#### Notes:

- Do not use the yellow video terminal.
- The A/V terminal doesn't put out any video, so connect the S-video terminals and check your TV, or check the LCD or the viewfinder as you add new sound. Always check the new sound with the speaker, or the headphones if you have the docking unit attached.

### To connect the external microphone:

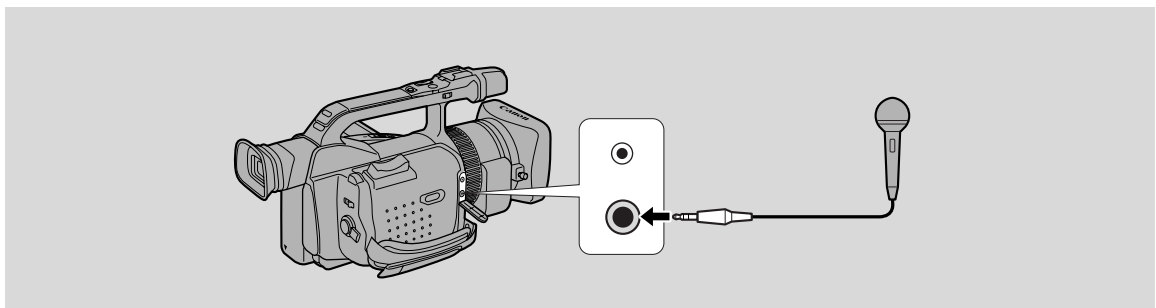

#### Notes:

- Use the audio or the microphone attenuator during audio dubbing if you need to lower the volume level or correct audio distortion of the input audio. Monitor the level of the input sound with headphones and if necessary, turn the attenuator on through the menu by selecting LINE ATT or MIC ATT and setting it to ON.
- When you add sound using the built-in microphone, make sure not to connect any cables to the MIC terminal.
- To use your TV to monitor video, connect the S-video terminal and the A/V terminal to your TV. You can monitor the sound with headphones.



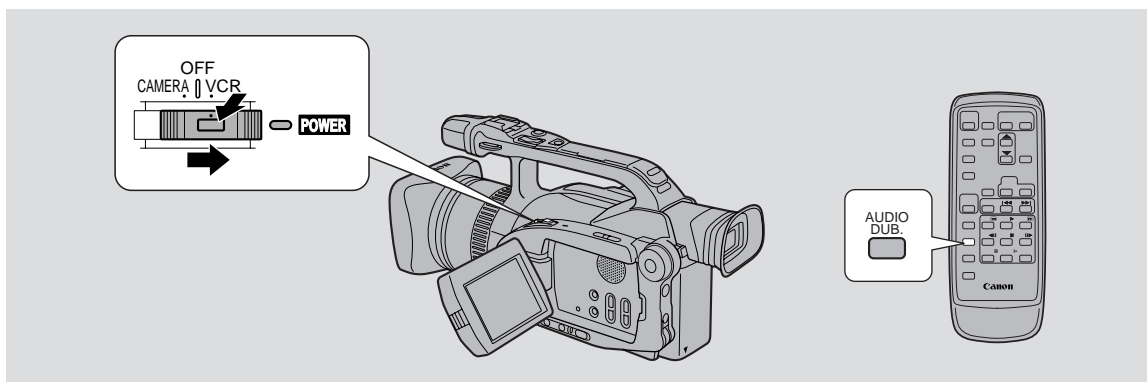

1. Load your recorded tape into the camcorder.
2. Slide the **POWER** switch to **VCR**.
3. Open the **VCR** menu, select **AUDIO DUB.**
4. Select **AUDIO IN** or **MIC IN** with the menu dial and close the menu.
5. Set the tape to the point where you want to start audio dubbing.
  - You can use the ◀◀, ▶▶, ▶, || and ■ buttons or special playback functions just as when in playback mode.
6. Press the **pause button**.
  - The camera becomes set to playback pause mode.
7. Press **AUDIO DUB.** on the wireless controller.
  - **AUDIO DUB.** and ●|| appear on the display.
8. Press the **pause button (and start play on the other audio device if AUDIO IN)**.
  - Audio dubbing starts.
  - If **MIC IN**, direct your voice into the microphone.
  - ●|| changes to ●.
9. When you get to the point where you want to stop dubbing, press the **stop button (and then stop play on the other audio device if AUDIO IN)**.
  - Audio dubbing stops and **AUDIO DUB.** disappears from the display.
  - The camera returns to stop mode.
  - You can also set zero set memory (p. 68) at the place you want to stop audio dubbing, then every time you return to that position, audio dubbing will cancel.
  - If instead of pressing ■ (STOP) you press || (PAUSE), the camera will return to the playback pause mode.

#### Notes:

- You can not use the DV terminal while adding sound.
- You might want to adjust the audio mix (p. 86) when playing back a tape with added sound.
- There may be a loss of sound quality if you add sound to a tape recorded on a camcorder other than the GL1.
- After adding sound three or more times to the same place on a tape, there may be some loss in sound quality.

## Preparing the Camera

E

### Adjust the viewfinder

- In record pause mode, adjust the viewfinder focusing lever to suit your eyesight.
- The viewfinder extends straight out and rotates upwards for comfortable viewing. Store the camera with the viewfinder flush with the body of the camera.
- To view with the viewfinder, make sure the LCD panel is either turned so that the subject can monitor viewing, or totally closed with the screen facing inwards.

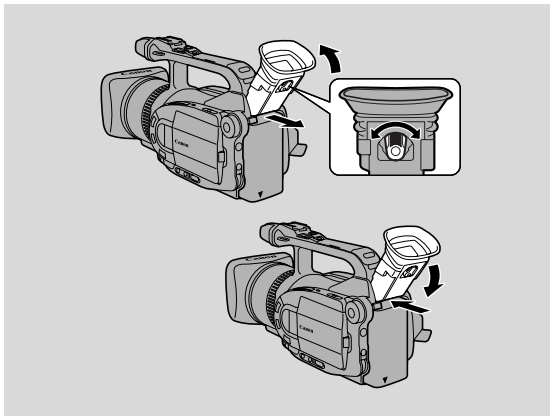

### Adjust the grip belt

- Adjust the length of the grip belt strap so that you can operate the start/stop button and zoom control effectively.

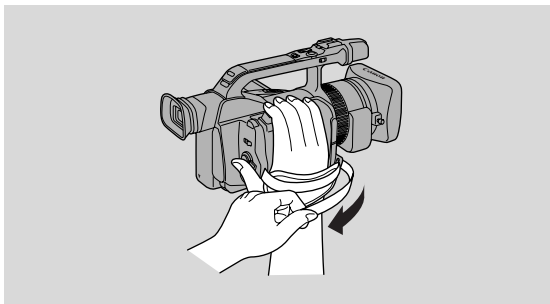

### Attach the shoulder strap

- For extra security and portability, attach the shoulder strap before using the camera.
- Pass the ends through the attachment bars and adjust the length as shown.

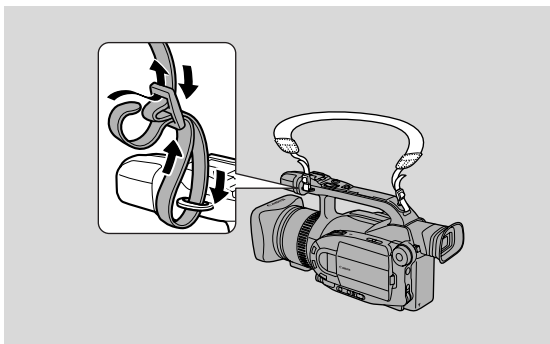

#### Note:

- Be careful not to leave the viewfinder exposed to bright sunlight, or it will melt. (The light is concentrated by the viewfinder lens.) Change the angle of the viewfinder so that the sun doesn't shine into it.

# Notes on Using the Batteries

E

## Charging and recording times

- These times vary — the safest policy is always to have two or three times as many battery packs as you think you will need.
- You will get more recording time if you turn the camera off between shots, instead of leaving it in record pause mode.

Battery pack		BP-915
Time needed for full recharge		2 hrs. 10 min.
Maximum recording time	Using the viewfinder:	65 min.
	Using the LCD screen:	60 min.

- Recording time will be shorter than usual at low temperatures. You can use the battery pack between 32° and 104°F (0° to 40°C), but it works best between 50° and 86°F (10° to 30°C).
- If the battery pack starts to give you much less recording time than usual, it has reached the end of its life and must be replaced.
- See p. 13 for times for other battery packs.

## How much power is left?

The indicator in the display shows you approximately how much charge the battery pack has left:

### Notes:

- “CHANGE THE BATTERY PACK” appears in the display for 4 seconds when the power is completely exhausted. The empty battery mark then appears and starts to flash. The power indicator light also flashes.
- The indicator is not constant — different levels will be shown when you subject the battery pack and camcorder to different conditions.

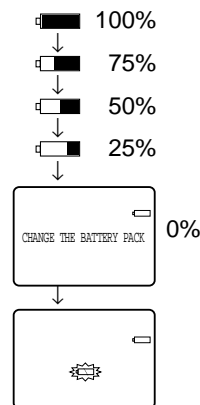

## Remaining time indicator

Tells you how many minutes of power remain in the battery pack. Only appears when you attach the BP-930R battery pack directly to the camera. (It doesn't appear if you use the CH-910 Dual Battery Charger/Holder.)

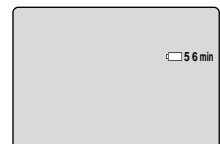

## When to recharge

You can recharge a lithium ion battery pack whenever it is convenient. Unlike a conventional battery pack, it does not have to be fully discharged first. However, as the battery pack will naturally discharge itself over time, it is best to charge it the same day you plan to use it, or the day before.

## Taking care of the battery pack

### Always attach the terminal cover.

- Do not allow any metal objects to touch the terminals, as this can cause a short circuit and damage the battery pack. Attach the terminal cover whenever the battery pack is not being used.

### Keep the terminals clean.

- The camera, adapter or battery pack will not work properly if the terminals are dirty. Check them before use, and wipe them with a dry cloth or tissue if necessary.

### Storing the battery pack.

- If you do not use a battery pack for a period of more than a few months any remaining charge may cause damage to the battery pack, and reduce usage time. To prevent damage therefore, aim to use a battery pack's complete charge before storage.

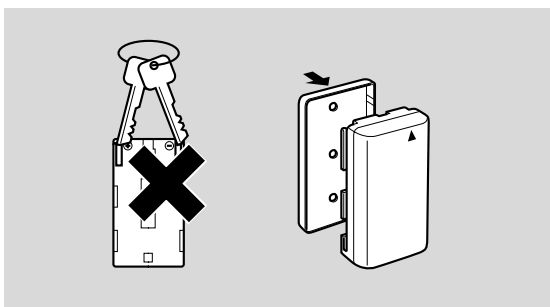

## Charging the backup battery

A rechargeable lithium battery installed into the camera unit allows the camera to remember settings such as the date and time, even when the battery pack is disconnected. It is automatically recharged when you attach a power source to the camcorder.

When you first use the camera, bring the backup battery to full charge by connecting a power source to the camera for a full day (about 24 hours). You do not need to turn the camera on for charging to take place.

- If you use the camcorder regularly, the backup battery will remain charged. If it is stored, however, it slowly discharges and eventually (in excess of 6 months from being fully charged) there will be insufficient power to maintain the date and time. In this case, connect a power source to the camcorder, reset the date and time (p. 39) and recharge the backup battery.
- If you discard this product, dispose of the lithium backup battery separately to prevent pollution. For further information, contact your local Canon service center or dealer.

**DANGER!****Treat the battery pack with care.**

- Keep it away from fire (or it might explode).
- Do not expose the battery pack to temperatures greater than 140°F (60°C). Do not leave it near a heater, or inside a car in hot weather, for example.
- Do not try to disassemble or modify it.
- Do not drop or knock it.
- Do not get it wet.

## Setting the Audio Mix

E

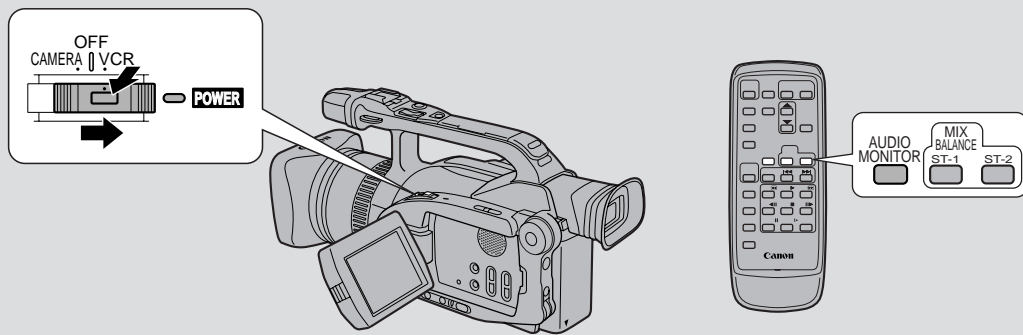

When you play back a tape that was recorded in 12-bit mode, you can set the audio output to play: stereo 1 (the original sound), stereo 2 (any new sound, dubbed to the tape after recording), or mix the balance between the two.

- Audio from the 16-bit mode only contains stereo 1 sound and so you cannot/do not need to select the audio mix. The same is true for the 12-bit stereo 1 mode, unless new sound has been added post-recording.
- You can choose the output using the wireless controller only.

### 1. Set the camera to VCR mode.

### 2. Choose the output.

- Press AUDIO MONITOR on the wireless controller.
- Four settings appear as you push the button:
  - STEREO1 for just stereo 1.
  - STEREO2 for just stereo 2.
  - MIX/FIXED for an equal mix of stereo 1 and 2.
  - MIX/VARI. (mix variable) for when you want to mix the balance between stereo 1 and 2.
- To simply choose STEREO1, STEREO2 or MIX/FIXED, make sure your choice appears on the display.
- If you choose MIX/VARI., you can go on to mix the balance.
- Use the ST-1/ST-2 keys to mix the balance. A bar showing the mix appears on the screen for four seconds.

### Notes:

- When you have chosen the output, STEREO1, STEREO2, MIX/FIXED or MIX/VARI. is shown in the top left of the display for a few seconds.
- If you turn the power off the output is set to STEREO1, however, if you select MIX/VARI. again with the wireless controller, your previously mixed balance will appear.

## Selecting audio output channels

When you play back a tape whose audio has been recorded on multiple channels, you can change the output channels of that sound.



▶OUTPUT CH...L/R

1. Set the camera to VCR, load a tape recorded with multiple-channel audio.
2. Open the VCR menu and select OUTPUT CH.
3. Select the output channel.
  - Refer to the following list.

OUTPUT CH setting	Played back sound	
	Tape recorded with stereo sound	Tape recorded on multiple channels
L/R	L + R channels	main + sub
L/L	L channel only	main only
R/R	R channel only	sub only

## Camera Holding Styles

E

### Choose the grip

- You can grip the camera from the side grip or the top handle.
- Either gripping position allows you to start/stop recording, take a “photo” and zoom in and out.
- Lock the top controls to prevent accidental operation by sliding across the LOCK lever.

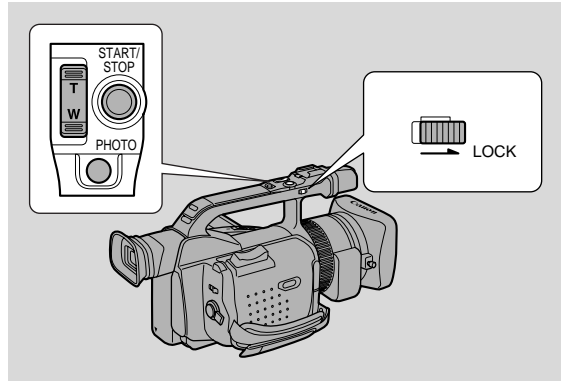

### Standard holding style

For maximum stability, place your right hand through the side grip belt and keep your right elbow pressed against your body. Support the lens with your left hand.

### Low-angle recording

Grip the camera using the top handle and steady the lens with the other hand.



## Cautions

### **Avoid high temperatures and high humidity.**

- Do not leave the camera inside a car in hot weather, for example.
- Be careful of heat radiating from video lighting equipment.
- Do not take the camera into a humid room.

### **Avoid sudden changes in temperature.**

- If you take the camera from a cold place to a warm place, condensation may form on the lens and internal parts (see p. 91).

### **Do not point the lens or viewfinder at strong light sources.**

- Never point it at the sun, and do not leave it aimed at a bright subject.
- Be especially careful when leaving the camera on a tripod.

### **Avoid magnetic or electric fields.**

- Do not use the camera close to TV transmitters, portable communication devices or other sources of electric or magnetic radiation. They may cause picture interference, or permanently damage the camera.

### **Do not expose the camera to water.**

- Cover the camera when you are recording in rain or mist.
- There is a risk of electric shock if water gets inside the camera — contact qualified service personnel as soon as possible.

### **Protect the lens.**

- Sand and dust can damage the lens — be especially careful on windy days.

### **Handle the camera gently.**

- Vibration or shock can cause damage.
- Do not use the viewfinder, LCD panel or microphone as a carrying handle.
- Do not swing the camera around when carrying it by the handle; knocking the camera against things may cause it to malfunction.

### **Do not disassemble the camera.**

- This is very dangerous as there is a risk of electric shock — if the camera does not function properly, take it to qualified service personnel.

## Storage

If you do not intend to use the camera for some time, turn the POWER switch to OFF and store it in an area which is free of dust and moisture, and where the temperature is no higher than 86°F (30°C). After storage, check each part and function of your camera to make sure everything is still working properly.

### **Note:**

- These cautions also apply to accessories such as battery packs and cassettes.

## Maintenance

### LCD

- Clean the LCD screen using a commercially available glass cleaner.
- Where there is a big change in temperature, moisture may form on the surface of the screen. Wipe clean with a soft, dry cloth.
- At low temperatures the display may appear to be much darker than usual. This is not a fault, and as the screen warms up the display will return to normal.

### Camera body and lens

- Use a soft, dry cloth to clean the camera body or lens. Never use chemically treated cloth or volatile solvents such as paint thinner.

### Video heads

- When mosaic-like noise appears on the playback picture, the video heads may be dirty. When the video heads are badly contaminated, the camera may show a blank blue screen.
- Clean the video heads using Canon's DVM-CL Digital Video Head Cleaning Cassette. If the "noise" remains, repeat the cleaning (up to maximum of five times).
- Do not use a wet-type cleaning cassette, as this can cause damage.



## Using the camera abroad

### Power sources

- You can use the compact power adapter to operate your camera and charge battery packs in any country where the electricity supply is between 100 and 240 V AC, 50–60 Hz. Contact your Canon dealer for information about plug adapters for overseas use.

### TV playback

- Although you can always play back your recordings in the viewfinder, your camera can only be connected to TVs which use its NTSC system. This TV system is used in the following countries: American Samoa, Bahama, Barbados, Bermuda, Bolivia, Canada, Chile, Colombia, Costa Rica, Cuba, Ecuador, El Salvador, Guam, Guatemala, Greenland, Haiti, Honduras, Jamaica, Japan, Korea, Mexico, Micronesia, Myanmar, Nicaragua, Panama, Peru, Philippines, Puerto Rico, Saint Lucia, Surinam, Taiwan, Trinidad and Tobago, USA, Venezuela.

## Condensation

Condensation may form on the camera when it is moved from a cold place to a warm place. Using the camera while condensation is present can damage both the tape and the camera.

Condensation may become a problem:

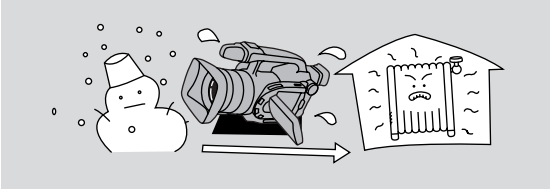

When you take the camera from a cold place to a warm room

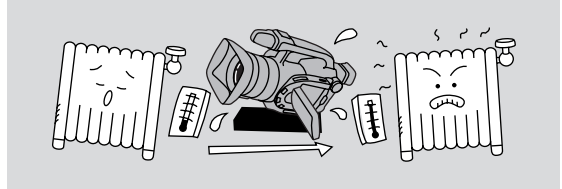

When a cold room is heated rapidly

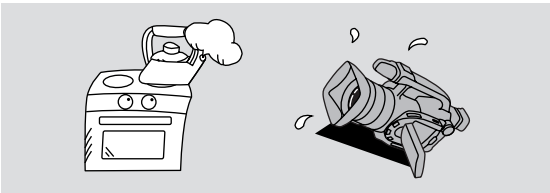

When the camera is left in a humid room

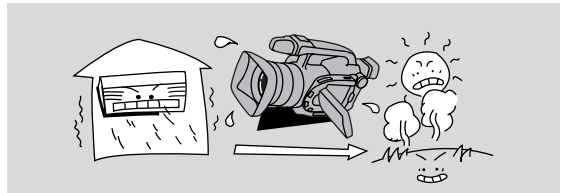



When the camera is taken from an air-conditioned room to a warm, humid place

### Protecting the camera from condensation

- Before you bring the camera to a warm or humid place where condensation is likely to be a problem, unload the cassette and put the camera in a plastic bag. Wait until the camera reaches room temperature before you take it out of the bag.

### What happens when condensation is detected

- “CONDENSATION HAS BEEN DETECTED” is displayed for approximately four seconds. Then, the power indicator flashes and the  mark flashes in the display. If there is a cassette in the camera, it stops automatically and “REMOVE THE CASSETTE” is displayed for approximately four seconds and then  flashes in the display. If you have the beep turned on, it will sound five times.
- The camera may not detect the condensation immediately — the condensation warning may not start flashing for 10 to 15 minutes.
- You cannot load a cassette when condensation is detected.

### What you should do

- Remove the cassette, leave the cassette compartment open, and turn the camera off.
- Leave it in a dry place until the condensation evaporates. After the condensation warning stops flashing, wait at least another hour before trying to use the camera.

## Troubleshooting

E

Refer to this checklist first if you have any problems with your camcorder. Possible explanations are given for each problem on the list — turn to the page numbers in brackets for more information.

Make sure that the camera is properly connected if you are using it with a TV or VCR. Consult your dealer or service outlet if problems persist.

### Recording/Playback

#### Problem

#### Cause and/or what to do about it

**❓ Nothing happens when I press the buttons.**

- The camera is not switched on (p. 21, 28).
- The cassette is not loaded or is set for erasure prevention (p. 19-20).
- The tape has reached the end.
- The battery pack is exhausted or not properly attached (p. 16-17, 83).
- The function cannot be used in that recording program (p. 48).
- The top controls are locked by the lock lever (p. 88).

**❓ The camera turned itself off.**

- The camera was in record pause mode for more than about five minutes (p. 21).
- The battery pack is exhausted (p. 17, 83).

**❓ The start/stop button doesn't work.**

- The POWER switch is not set to CAMERA.
- The standby lever is set to LOCK (p. 21).
- The cassette is not loaded or is set for erasure prevention (p. 19-20).
- The tape has reached the end.

**❓ There's no picture in the display.**

- The POWER switch is not set to CAMERA.
- The standby lever is set to LOCK (p. 21).
- The camera has not been used for a long while, it is not a malfunction. Take off the battery and reattach.
- The lens cap is attached.

**❓ There's a blank blue screen in the display.**

- You are attempting to play back or record from a copyright protected cassette (p. 75).
- The video heads are badly contaminated (p. 90).

**❓ The camera won't focus.**

- The camera is on manual focus (p. 58).
- The viewfinder lens needs adjusting (p. 82).
- The lens is dirty (p. 90).

**Note:**

- Some subjects are not suitable for autofocus. In these situations, you will often get better results using manual focus (see p. 58). Focus on something which is about the same distance away, lock the focus, and then point the camera at your original, hard-to-focus subject.

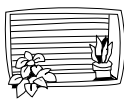

Horizontal stripes



Many subjects at different distances



Behind glass

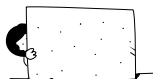

Without much contrast (e.g. a white wall)



Reflective surfaces (e.g. shiny car surfaces)



Fast moving objects



Slanted subjects



Dark subjects



Night scenes

### Recording/Playback (Contd.)

**Problem****Cause and/or what to do about it**

**?** Some/all of the digital effects don't work, or can't be set.

- There are a number of restrictions on using the digital effects. Refer to the notes on p. 52.

**?** The ► (play) button doesn't work.

- The POWER switch is not set to VCR (p. 28).
- The cassette is not loaded (p. 19).
- The tape has reached the end.

**?** There's a bright stripe on the screen.

- When recording in dark places a bright light in the scene may cause a vertical light bar ("smear") to appear. This is a normal feature of camcorders.

**?** The playback picture is rough (with mosaic-like noise).

- The video heads need cleaning (p. 90).

**?** There's no picture on the TV screen, even though the tape is moving.

- The video heads need cleaning (p. 90).
- The TV/VIDEO selector on the TV isn't set to VIDEO (p. 30).

**?** There's no sound coming from the speaker during playback.

- The speaker has been turned off with the volume buttons (p. 27).
- Headphones are being used.

## Miscellaneous

### Problem

❓ **The wireless controller doesn't work.**

❓ **The tally lamp doesn't flash.**

❓ **There are air bubbles inside the lens.**

❓ **After sliding the POWER switch to CAMERA, there is visible movement in the lens for about 2 seconds.**

❓ **The camera malfunctions.**

❓ **The DV cable is connected correctly, but there's nothing in the display.**

❓ **The camera becomes warm during use.**

### Cause and/or what to do about it

- The remote sensor mode is set to OFF (OFF) in the menu (p. 37).
- The remote sensor modes of the wireless controller and the camera itself are different (p. 37).
- The batteries are dead or not inserted.
- It is turned off (p. 38).
- This is unlikely, but may happen if you use the camera in places where the air pressure is low, in an airplane for example. The bubbles will disappear a week or so after you return the camera to normal atmospheric pressure.
- The camcorder is preparing the lens for image stabilization. This is not a malfunction.
- External interference may cause the camera's microprocessor to malfunction temporarily. If random letters appear in the display or if normal operation is interrupted, remove and then replace the power source.
- If the camera still does not operate properly, press the RESET button (on the camera body behind the LCD panel, p. 8) using the tip of a ball point pen (or similar). Camera functions return to their default settings.
- Remove the cable and then reconnect it or turn the power off and back on again.
- This is not a malfunction.

### About the LCD Viewfinder

Liquid Crystal Viewfinders use extremely high-precision technology, but there will be pixels which do not light up or which are continuously lit. This is not an error and will not affect the recording.

### About the CCD

Due to the construction of the CCD, in low-light recording, small specks of light may become visible in the viewfinder. In such cases, increase the shutter speed, reduce the gain or use an additional light source such as a video light.

# Screen Displays

To display the date and time on a connected TV, press the wireless controller's DATA CODE button when the camera is in VCR mode with a tape loaded. See p. 65 also.

Press the wireless controller's TV SCREEN button to see or hide the other displays on the TV screen. (The displays appear white on-screen.) They will not be added to any recordings you make with the camera. You can also display or hide (for a clear screen while recording) the displays through TV SCREEN in the camera menu. For instructions on how to hook the camera up to your TV, see p. 30.

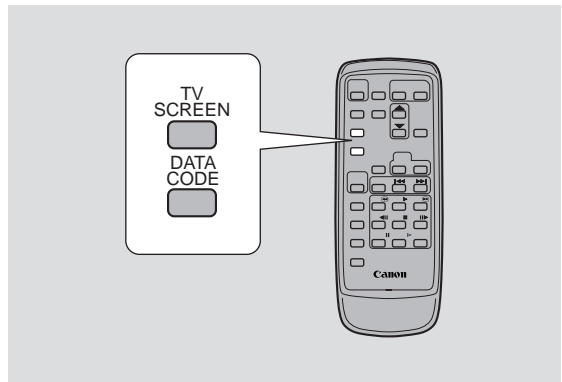

E

If you slide the POWER switch to OFF while in VCR mode, the DATA CODE and TV SCREEN will reset to show a clear screen.

 indicates a flashing display.

## Turning off the LCD screen displays

You can turn off the displays to give you a clear screen for playback.

Set the camera to VCR mode, open the VCR menu (page 34) and choose the DISPLAYS option. Set the displays to OFF <PLAYBK> and then close the menu.

- The LCD screen will now be completely blank, but the camera will continue to show warning/caution displays when necessary.

Record pause mode (p. 21)



Recording (p. 21)



Shows how much battery power remains (p. 83).



The battery pack is exhausted (p. 83).



No cassette is loaded, or it is set for erasure prevention (p. 19-20).



Remaining tape (Green: more than 5 min. Yellow: less than 5 min. Red: final few secs).



...finally, it tells you when you have completely run out of tape.



The camera is ejecting the tape (p. 19).



The safety mechanism is activated. Unload the cassette and turn the camera off. Turn it on again and reload the cassette.

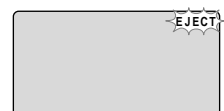

Recording mode (p. 22)



Playback is stopped (p. 28).



Normal playback (p. 28)



Fast forward (p. 28)



Rewind (p. 28)



Fast forward playback (p. 28)



Rewind playback (p. 28)



Frame advance playback (p. 29)



Frame reverse playback (p. 29)



Playback pause (forward and reverse) (p. 28)



Slow playback (forward and reverse) (p. 29)

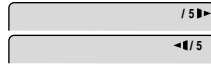

×2 playback (forward and reverse) (p. 29)



×1 playback (forward and reverse) (p. 29)



Photo Search (p. 67)



Date Search (p. 67)



Photo search is complete.

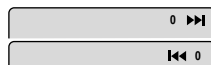

Zero set memory (forward and reverse) (p. 68)

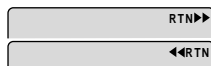

Zero set memory (p. 68)



A/V Insert Editing (p. 79)

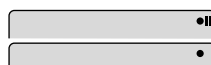

Audio Dubbing (p. 81)

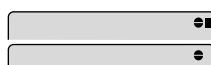

Zoom display (p. 24):  
Optical zoom

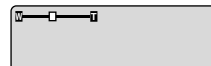

Optical plus 40× digital zoom

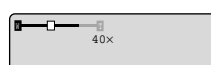

Optical plus 100× digital zoom

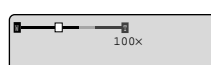

Zoom in

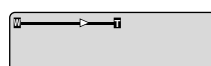

Zoom out

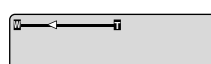

The image stabilizer is turned on (p. 33).



Camera menu (p. 34)

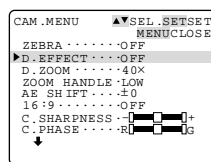

VCR menu (p. 34)

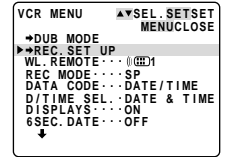

Record set up menu (p. 70)

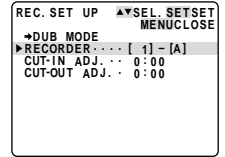

The remote sensor is turned off (p. 37).

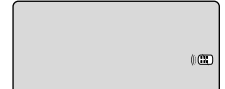

Self-timer countdown (p. 54)

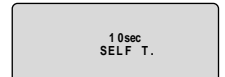

Audio mode (p. 53)



Data code (p. 65)

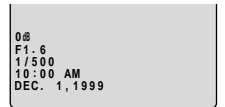
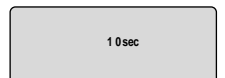

Photo mode (p. 43)

- Setting the AF
  - mark flashes white
- AF locked
  - mark lights up green
- Timer



Movie mode (p. 46)



Recording programs (p. 48)

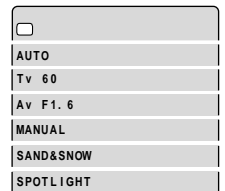

Flash is charging  
⚡ mark flashes white (p. 45) or charged



⚡ mark lights up green (p. 45)

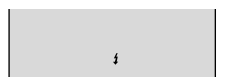



Manual exposure display (p. 57):  
Exposure locked

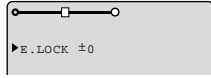

Brighter than standard exposure level

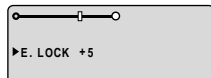

Darker than standard exposure level

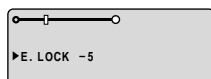

Manual setting of shutter speed, F number and gain value (p. 55)

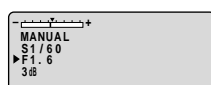

The iris is closed.





ND Filter (p. 42)



Manual focus is selected (p. 58).



White balance is (p. 63)  
Set   
Indoor   
Outdoor 

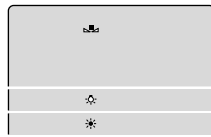

AE Shift (p. 59)

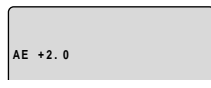

Camera Sharpness (p. 60)  
and Color Phase (p. 61)



The 16:9 effects: the display flashes when the effect has been selected, and appears steadily when it is activated (p. 52).

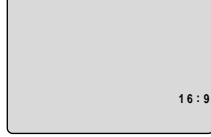

Digital effects: the display flashes when the function has being selected and appears steadily when it is activated (p. 51).

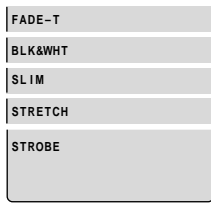

The wind screen is turned on (p. 53).



Volume level (p. 27)

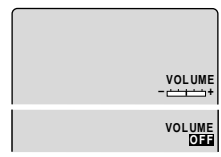

Screen brightness (p. 26)

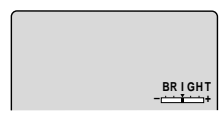

Gain (p. 56)



Audio output (p. 86)

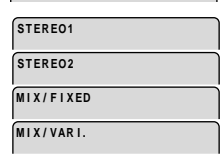

Mix balance (p. 86)

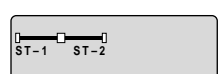

Audio/visual insert (p. 79)



Audio dubbing (p. 81)

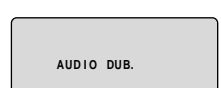

Microphone attenuator (p. 23, 31, 80)

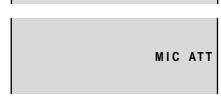

Line audio attenuator (p. 80)

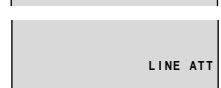

Audio input (p. 81)

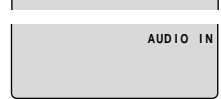

Microphone input (p. 81)



DV input (p. 75)



Condensation warning (p. 91)



## Time Code

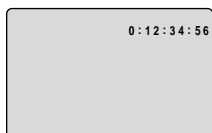

This records counter information, including hour, minute, second, and frame number on a special data code area on the tape itself. It is reset automatically when a new tape is loaded. In camera mode, the frame number doesn't appear in the display.

## Recording reminder

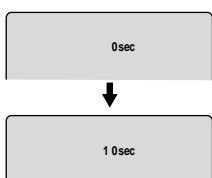

When you start recording, the camera counts from 0SEC to 10SEC. Shots which are shorter than 10 seconds may be difficult to edit later. On the other hand, if you are not planning to edit the recording, remember that a shot which does not contain action should generally last no longer than 10 seconds.

## Caution phrases

The camera displays various caution phrases — they appear for 4 seconds before disappearing.

Appears each time you turn the power on, until you set the date and time (p. 39).

SET THE TIME ZONE,  
DATE AND TIME

Appears when the battery pack is exhausted (p. 83).

CHANGE THE BATTERY PACK

Appears when the tape has reached the end.

TAPE END

Refer to page 20.

THE TAPE IS SET FOR  
ERASURE PREVENTION

Refer to page 91.

CONDENSATION  
HAS BEEN DETECTED

Appears as a warning to protect the tape and also when condensation is detected. Remove the tape as soon as possible after the camera has displayed the caution.

REMOVE THE CASSETTE

Refer to page 75.

COPYRIGHT PROTECTED  
PLAYBACK IS RESTRICTED

Refer to page 75.

COPYRIGHT PROTECTED  
DUBBING RESTRICTED

Appears when you try to do audio dubbing or A/V insert on a tape recorded in LP mode. Refer to page 78, 80.

CHECK THE CASSETTE  
[LP MODE]

Appears when you try to do audio dubbing on a tape recorded in 16-bit audio or 12-bit, 4-channel mode. Refer to page 80.

CHECK THE CASSETTE  
[AUDIO MODE]

Appears when the camera detects a blank section of a tape during audio dubbing or A/V insert. Refer to page 78, 80.

CHECK THE CASSETTE  
[BLANK]

# Specifications

## GL1

**Power Supply (rated):** 7.2 V DC

**Power Consumption (While recording with the AF turned on):**

6.7 W (Using viewfinder),

7.4 W (Using LCD screen)

**Television system:**

EIA standard (525 lines, 60 fields) NTSC color signal

**Video recording system:**

2 rotary heads, helical scanning system

DV system (Consumer digital VCR SD system)

Digital component recording

**Audio recording system:** PCM digital sound:

16 bit (48 kHz/2 ch), 12 bit (32 kHz/4 ch)

**Image sensor:** 3 CCD  $\frac{1}{4}$ " Pixel Shift (charge coupled device) 270,000 pixels (250,000 effective pixels)

**Tape format:** Videocassettes bearing the Mini DV mark

**Tape speed:**

SP:  $\frac{3}{4}$  ips (18.81 mm/s);

LP:  $\frac{1}{2}$  ips (12.56 mm/s)

**Maximum recording time:**

SP: 80 minutes (with an 80 min. cassette);

LP: 120 minutes (with an 80 min. cassette)

**Fast forward/rewind time:**

Approx. 2 min. 50 sec. (with a 60 min. cassette)

**Lens:** F/1.6–2.9, 20 $\times$  power zoom, 4.2–84 mm

**Focusing system:** TTL autofocus, manual focusing possible

**Minimum focusing distance:**

$\frac{3}{8}$  inch (10 mm) on maximum wide angle; telephoto end: 3 ft 4 in (1 m)

**Maximum shutter speed:**

1/15,000 sec.

**Minimum illumination:** 6 lx (using the auto program)

**Recommended illumination:**

More than 100 lx

**Filter diameter:** 58 mm

**Viewfinder:** 0.55-inch, color LCD

(approx. 180,000 pixels)

**LCD screen:** 2.5 in measured diagonally

(6.4 cm), 122,000 pixels (approx.)

**Microphone:** Stereo electret condenser microphone

**DV Terminal:** Special 4 pin connector (conforms to IEEE 1394)

**Output level:**

Video terminal:  $\phi$  3.5 mm, 1 V<sub>p-p</sub>/75  $\Omega$  unbalanced

S-video terminal: 4 pin mini DIN, 1 V<sub>p-p</sub> (Y signal), 0.286 V<sub>p-p</sub> (C signal)

Audio terminal:  $\phi$  3.5 mm

4 dBm (47 k $\Omega$  load)/3 k $\Omega$  or less, unbalanced

**Input level:**

Audio terminal:  $\phi$  3.5 mm (L, R)

0 dBV/47 k $\Omega$  (LINE ATT), unbalanced

–10 dBV/47 k $\Omega$  (LINE), unbalanced

Microphone terminal:  $\phi$  3.5 mm stereo mini-jack,

–55 dBV (with 600  $\Omega$  mic) (MIC)/600  $\Omega$

–35 dBV (with 600  $\Omega$  mic) (MIC ATT)/600  $\Omega$

**Operating temperature range:**

32°–104°F (0°–40°C)

**Dimensions:** 4  $\frac{5}{8}$   $\times$  5  $\frac{3}{8}$   $\times$  10  $\frac{3}{4}$  in

(117  $\times$  135  $\times$  272 mm)

**Weight:** 2 lbs 12  $\frac{1}{8}$  oz approx. (1.25 kg)

## BP-915 Battery Pack

**Battery type:** Rechargeable lithium ion battery

**Rated voltage:** 7.2 V DC

**Operating temperature:** 32°–104°F (0°–40°C)

**Battery capacity:** 1,500 mAh

**Dimensions:** 1  $\frac{1}{2}$   $\times$   $\frac{3}{4}$   $\times$  2  $\frac{3}{4}$  in

(38.2  $\times$  20.5  $\times$  70.5 mm)

**Weight:** 3  $\frac{3}{8}$  oz (96 g)

Weight and dimensions are approximate.

Errors and omissions excepted.

Subject to change without notice.

Canon is a trademark of Canon Inc.

**A**

Abroad, Using the Camera, 90  
Accessories, 6  
Adapter, AC, 16  
AE Programs, 48  
AE Shift, 59  
Analog Line-in, 76  
Audio Dubbing, 80  
Audio Mix, 86  
Audio Mode, 53  
Audio Output, 87  
Audio Recording, 53  
Audio/Video Terminal, 30  
Auto, 49  
Autofocus, 58  
A/V Insert, 78  
Av Recording Mode, 50

**B**

Backup Battery, 84  
Basic Recording, 21  
Battery Pack, 6, 13, 17, 83  
Beep, 23

**C**

Cables, 6, 30  
Cassettes, 6, 19  
Charging the Battery Pack, 17  
Choosing a Recording Program, 48  
Cleaning the Camera, 90  
Clock, 40  
Color Phase, 61  
Condensation, 91  
Connection to TV or VCR, 30  
Cut-in and Cut-out, 73

**D**

Date and Time, 39  
DC Coupler, 6, 16  
Demo Mode, 23  
Digital Effects, 51  
Digital Video, 7  
Digital Zoom, 7, 24  
Displaying Data Code, 65  
Dubbing Function, 69  
DV Dubbing, 75

**E**

Easy Recording, 48  
Effects, 51  
Exposure, 55, 57  
External Microphone, 80

**F**

F Number, 56  
Fade Trigger, 51  
Fast Forward, 28  
Feedback, 30  
Finding Your Way Around the GL1, 8-11  
Flash Photography, 45  
Focusing, 58  
Frame Mode, 46

**G**

Gain, 56  
Grip Belt, 82

**H**

Head Cleaning, 90  
Headphones, 27

**I**

Image Stabilizer, 33  
Introducing the GL1, 7

**L**

LANC, 74  
LCD Screen, 25  
Lens Cap, 6  
Lens Hood, 6, 15  
Loading Cassettes, 19  
Low-angle Recording, 88  
LP Mode, 22

**M**

Maintenance, 89  
Manual Focus, 58  
Manual Recording Program, 50  
Menus, 34  
Microphone, 80  
Mirror, 26  
Movie Mode, 46

**N**

ND Filter, 42

**O**

Optical Image Stabilizer, 33  
Optional Accessories, 13

**P**

Photo Mode, 43  
Photo Search, 67  
Playback, 28  
Playback Connection, 30  
Playback Pause, 28  
Power Adapter, 6, 16  
Powering Your Camcorder, 16  
Pre-marked Position, 68  
Preparing the Camera, 82  
Problems, 92

**R**

Recharging the Battery Pack, 83  
Record Pause Mode, 21  
Record Review, 47  
Record Search, 47  
Recording, 21  
Recording Programs, 48  
Remote Control, 36  
Remote Sensor, 37  
Rewind, 28

**S**

S-video, 6, 30  
Sand and Snow, 50  
Screen Displays, 95  
Self-Timer, 54  
Sharpness, 60  
Shoulder Strap, 6, 82  
Shutter Speed, 56  
16:9, 52  
SP Mode, 22  
Specifications, 99  
Speedlite, 45  
Spotlight, 50  
STANDBY Lever, 21  
Still Pictures, 43  
Storage, 89  
System Diagram, 12

**T**

Tally Lamp, 36  
Tape Protection, 20  
Telephoto, 24  
Temperature, 85, 89  
Time Code, 98  
Tripod, 31  
Troubleshooting, 92  
TV, 30, 95  
Tv Recording Mode, 49

**U**

Using the Camera Abroad, 90  
Using the Menus, 34

**V**

VCR, 30  
Video Heads, 90  
Videocassettes, 19  
Viewfinder, 82

**W**

White Balance, 63  
Wide-angle, 24  
Widescreen TV, 52  
Wireless Controller, 6, 36

**Z**

Zebra Pattern, 62  
Zooming, 24

**U.S.A.**

**E**

## **CANON® GL1 DIGITAL VIDEO CAMCORDER LIMITED WARRANTY**

The limited warranty set forth below is given by Canon U.S.A., Inc. ("CUSA") with respect to each Canon GL1 Digital Video Camcorder ("DV Camcorder") purchased and used in the United States.

Each Canon DV Camcorder, when delivered to you in new condition in its original container, is warranted against defective material or workmanship as follows: for a period of one (1) year from the date of original purchase (three (3) months in the case of the video head part), defective parts or DV Camcorders returned to a CUSA factory service center ("CUSA Center") or an authorized DV Camcorder service facility ("Service Facility"), and proven to be defective upon inspection, will be repaired or exchanged for new or comparable rebuilt parts or DV Camcorders. The warranty period for repaired or replacement parts or DV Camcorders shall begin upon shipment of the same, but shall in no event exceed the original warranty period of the defective part or DV Camcorder.

**Non-Canon brand peripheral equipment and software which may be distributed with Canon DV Camcorders are sold "AS IS", without warranty of any kind by CUSA, including any implied warranty regarding merchantability or fitness for a particular purpose. The sole warranty with respect to such non-Canon brand items is given by the manufacturer or producer thereof.**

CUSA shall have no responsibility under this limited warranty for use of Canon DV Camcorders in conjunction with incompatible peripheral equipment and incompatible software.

In order to obtain warranty service, contact the authorized Canon retail dealer from whom you purchased the DV Camcorder or call the CANON INFORMATION CENTER AT 1-800-828-4040 (which is open from 9:00 a.m. to 5:00 p.m. (E.S.T.), Monday through Friday, excluding holidays). Have your unit serial number and your date of purchase available when you make the call to expedite service. In either case you will be directed to ship the DV Camcorder, postage prepaid, to the CUSA Center or Service Facility nearest to you. You must include a copy of the proof of purchase (bill of sale) and a complete explanation of the problem. DV Camcorders covered by this limited warranty will be repaired and returned to you without charge by the CUSA Center or the Service Facility. Repairs not under warranty will be at such cost as the CUSA Center or Service Facility may from time to time generally establish.

This limited warranty covers all defects encountered in normal use of the DV Camcorder, and does not apply in the following cases:

- (a) Loss of or damage to the DV Camcorder due to abuse, mishandling, improper packaging by you, alteration, accident, leaking batteries, exterior nicks, scratches or dents, electrical current fluctuations, failure to follow operating instructions, maintenance and environmental instructions prescribed in CUSA's instruction manual, or service performed by other than a CUSA Center or Service Facility.
- (b) Use of parts or supplies (other than those sold by CUSA) which cause damage to the DV Camcorder or cause abnormally frequent service calls or service problems.
- (c) If any DV Camcorder has had its serial number or dating altered or removed.

This limited warranty does not apply to accessories or consumables for the DV Camcorder, which are sold "AS IS", without warranty of any kind by CUSA.

**NO IMPLIED WARRANTY, INCLUDING ANY IMPLIED WARRANTY OF MERCHANTABILITY OR FITNESS FOR A PARTICULAR PURPOSE, APPLIES TO THE DV CAMCORDER AFTER THE APPLICABLE PERIOD OF EXPRESS WARRANTY STATED ABOVE, AND NO OTHER EXPRESS WARRANTY OR GUARANTY, EXCEPT AS MENTIONED ABOVE, GIVEN BY ANY PERSON, FIRM OR CORPORATION WITH RESPECT TO THE DV CAMCORDER SHALL BIND CUSA. (SOME STATES DO NOT ALLOW LIMITATIONS ON HOW LONG AN IMPLIED WARRANTY LASTS, SO THE ABOVE LIMITATION MAY NOT APPLY TO YOU) CUSA SHALL NOT BE LIABLE FOR LOSS OF REVENUES OR PROFITS, EXPENSE FOR SUBSTITUTE EQUIPMENT OR SERVICE, STORAGE CHARGES, LOSS OF DATA, OR ANY OTHER SPECIAL, INCIDENTAL OR CONSEQUENTIAL DAMAGES CAUSED BY THE USE, MISUSE OR INABILITY TO USE THE DV CAMCORDER, REGARDLESS OF THE LEGAL THEORY ON WHICH THE CLAIM IS BASED, AND EVEN IF CUSA HAS BEEN ADVISED OF THE POSSIBILITY OF SUCH DAMAGES. NOR SHALL RECOVERY OF ANY KIND AGAINST CUSA BE GREATER IN AMOUNT THAN THE PURCHASE PRICE OF THE DV CAMCORDER SOLD BY CUSA AND CAUSING THE ALLEGED DAMAGE. WITHOUT LIMITING THE FOREGOING, YOU ASSUME ALL RISK AND LIABILITY FOR LOSS, DAMAGE OR INJURY TO YOU AND YOUR PROPERTY AND TO OTHERS AND THEIR PROPERTY ARISING OUT OF USE, MISUSE OR INABILITY TO USE THE DV CAMCORDER NOT CAUSED DIRECTLY BY THE NEGLIGENCE OF CUSA. (SOME STATES DO NOT ALLOW THE EXCLUSION OR LIMITATION OF INCIDENTAL OR CONSEQUENTIAL DAMAGES, SO THE ABOVE LIMITATION MAY NOT APPLY TO YOU.) THIS LIMITED WARRANTY SHALL NOT EXTEND TO ANYONE OTHER THAN THE ORIGINAL PURCHASER OF ANY DV CAMCORDER, OR THE PERSON FOR WHOM IT WAS PURCHASED AS A GIFT, AND STATES YOUR EXCLUSIVE REMEDY.**

This limited warranty gives you specific legal rights, and you may also have other rights which vary from state to state.

**Canon U.S.A., Inc.**  
One Canon Plaza  
Lake Success, New York 11042

**CANON CONSUMER DIGITAL VIDEO EQUIPMENT LIMITED WARRANTY**

The limited warranty set forth below is given by Canon Canada Inc. ("Canon Canada") with respect to Canon digital video equipment purchased in Canada. This limited warranty is only effective upon presentation of a bill of sale or other proof of purchase for this Canon digital video equipment to a Canon Service Facility when repairs are required.

Canon consumer video digital equipment is warranted under normal, non-commercial, personal use, against defective materials or workmanship as follows:

**Parts:** Defective parts will be exchanged for new parts or, at Canon Canada's option, comparable rebuilt parts for a period of one year from the date of original purchase, except Video Heads which will be exchanged for a period of 3 months from the date of purchase.

**Labour:** For a period of one year from the date of original purchase, labour will be provided free of charge by our Canon Service Facilities in Canada.

This limited warranty covers all defects except where:

(a) The loss or damage to the product results from:

- i) accident, natural disaster, mishandling, abuse, neglect, unauthorized product modification or failure to follow instructions contained in the instruction manual;
- ii) the use of accessories, attachments, products, supplies, parts or devices with this Canon product that do not conform to Canon specifications or that cause abnormally frequent service problems;
- iii) repairs or services performed by any party other than a Canon Service Facility;
- iv) defective batteries or any exposure to water, sand or dirt;
- v) shipping (claim must be presented to the shipper);

(b) Any serial number on the video equipment is altered or removed.

(c) The digital video equipment is used for commercial, professional or industrial purposes.

This limited warranty does not cover the cabinet (exterior finish) of the digital video equipment, video cassette tapes, head cleanings, nor does it apply to digital video equipment purchased outside Canada.

**TO OBTAIN WARRANTY SERVICE**

Ship your Canon digital video equipment in its original carton, box or equivalent, properly packed, fully insured with shipping charges prepaid, together with a copy of your bill of sale or other proof of purchase and a description of the problem to any of the Canon Service Facilities in Canada.

**LIMITATIONS**

Except as otherwise required by applicable legislation, this warranty is in lieu of all other warranties, conditions, guarantees or representations, express or implied, statutory or otherwise, relative to this Canon product, including implied warranties or conditions of merchantability or fitness for a particular purpose.

Canon Canada assumes no liability for special, consequential or incidental damages or loss that may arise, whether on account of negligence or otherwise, from the use, misuse or inability to use this Canon product (including loss of profit, revenue, video tapes or enjoyment) or from failure to conform to any express or implied warranties, conditions, guarantees or representations. Any recovery under this limited warranty shall not exceed the purchase price of the product. Canon Canada does not assume or authorize any other person to assume for Canon Canada any other liability with respect to this Canon product.

This warranty does not extend to any person other than the original purchaser of this Canon product or the person for whom it was purchased as a gift and states your exclusive remedy.

**NOTICE TO CONSUMER**

If you plan to take important videos or if the product has not been used for some time, please check all functions with the instruction book before using it.

# Canon

## CANON INC.

**U.S.A.** ————— **CANON U.S.A., INC. NEW JERSEY OFFICE**  
100 Jamesburg Road, Jamesburg, NJ 08831 USA

**CANON U.S.A., INC. CHICAGO OFFICE**  
100 Park Blvd., Itasca, IL 60143 USA

**CANON U.S.A., INC. LOS ANGELES OFFICE**  
15955 Alton Parkway, Irvine, CA 92718 USA

**CANON U.S.A., INC. HONOLULU OFFICE**  
1020 Auahi Street, Bldg. #8, Honolulu, HI 96814 USA

- **If you have any questions, call the Canon U.S.A. Information Center toll-free at 1-800-828-4040 (U.S.A. only).**

**CANADA** ————— **CANON CANADA INC. NATIONAL HEADQUARTERS**  
6390 Dixie Road, Mississauga, Ontario L5T 1P7

**CANON CANADA INC. CALGARY**  
2828, 16th Street, N.E. Calgary, Alberta T2E 7K7

**CANON CANADA INC. MONTREAL**  
5990 Côte de Liesse, Quebec H4T 1V7

- **If you have any questions, call the Canon Canada Information Center toll-free at 1-800-828-4040 (Canada only).**

- **Si vous avez des questions, veuillez téléphoner sans frais au Canada 1-800-828-4040 (Canada seulement).**

**MEXICO** ————— **CANON MEXICANA, S. DE R.L. DE C.V.**  
Periferico Sur No. 4124 Col. Ex-Rancho de Anzaldo C.P. 01900  
México, D.F., México

**CENTRO Y SURAMÉRICA** ————— **CANON LATIN AMERICA, INC.**  
6505 Blue Lagoon Drive Suite 325 Miami FL 33126 USA

**ASIA** ————— **CANON HONGKONG COMPANY LTD.**  
9/F, The Hong Kong Club Building, 3A Chater Road, Central, Hong Kong



Printed on 70% reused paper.  
Document réalisé avec du papier recyclé à 70%.  
El papel aquí utilizado es 70% reciclado.