



Multi-Functional Digital Video / Camera w/1.5" LCD Color Display

# Operating Instructions

---

Model: DC500

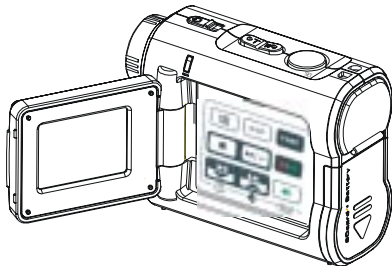
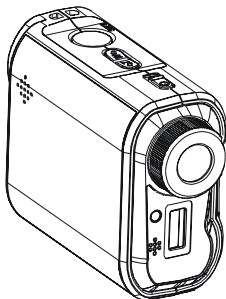

128-7261

# Table of Contents

<b>Getting Started</b>	
Getting to Know Your Digital Video Recorder.....	3
Using the Panel.....	5
Power.....	6
Modes.....	7
<b>Video Mode</b>	
Taking Movies.....	11
Video Out.....	12
<b>Camera Mode</b>	
Taking Pictures.....	13
<b>Voice Record Mode</b>	
Recording Voice Messages.....	15
<b>MP3 Mode</b>	
Listening To MP3 Music.....	17
<b>PLAYBACK Mode</b>	
Basic Playback.....	19
Advanced Playback.....	21
<b>Main Functions</b>	
Changing the Quality Setting.....	23
Using Self-timer.....	25
Using Guide Line/The LCD Display.....	26
Using Hold.....	27
Volume Adjust.....	27
<b>Advanced Functions</b>	
Attention Icon.....	28
Menu.....	29
Troubleshooting .....	37
HOW TO COPY FILES FROM THE UNIT TO YOUR COMPUTER .....	38
HOW TO COPY MP3 FILES TO YOUR UNIT .....	38
BASIC WINDOWS 98/2000/XP COPY AND PAST HELP .....	39

# Getting to Know Your Digital Video Recorder

## Front View

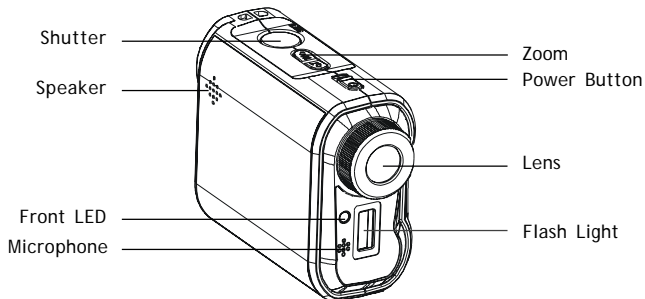

## Back View

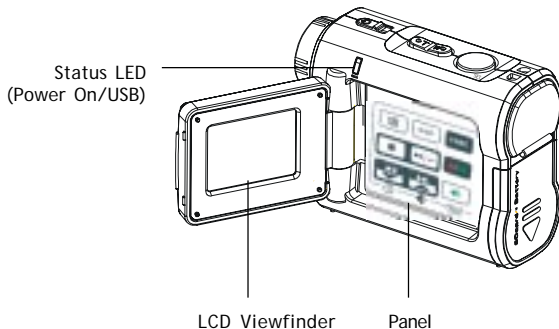

Subject to Change

## Getting to Know Your Digital Video Recorder-continued

## Side View

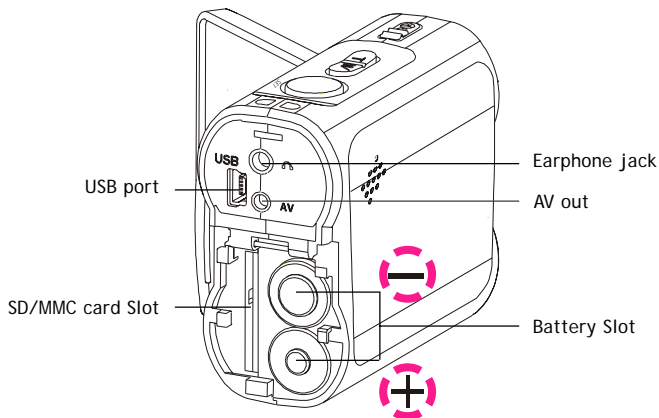
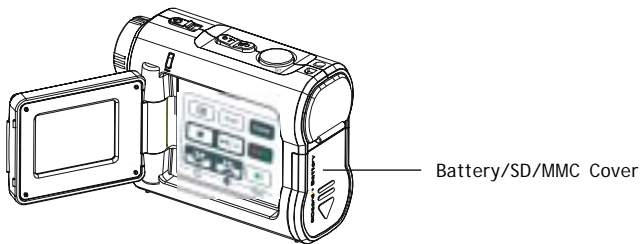

Subject to Change

## Using the Panel

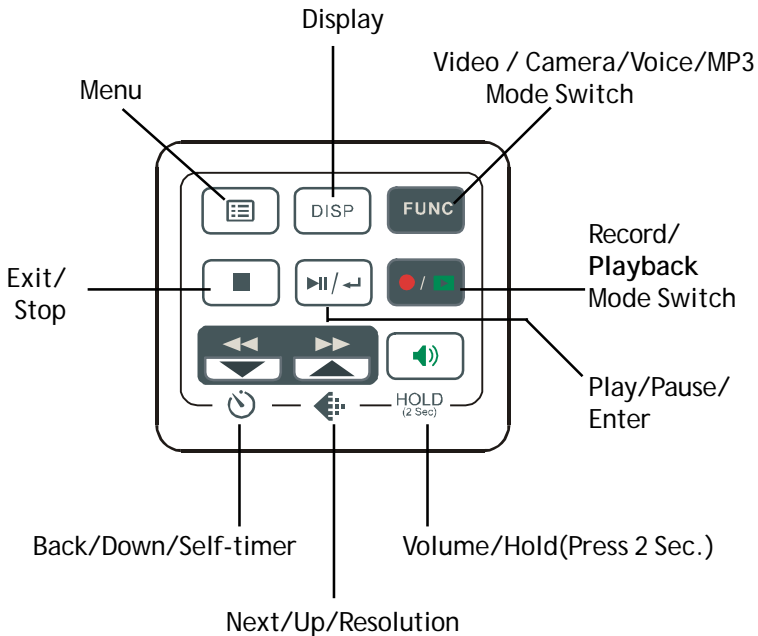

## Power

---

### Power On/Off

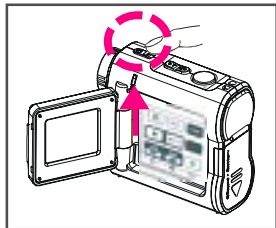

Nudge the Power slider to activate your Digital Video Recorder. When Power is on, the Power indicator lights up green. Nudge the Power slider again to turn this unit off.

### Power Low

If your battery is low, you will see a battery icon (  ) shown on the top center of the LCD.

If your battery is about to run out, you will see a blinking battery icon (  ) shown on the top center of the LCD. Your Digital Video will turn off itself in several seconds.

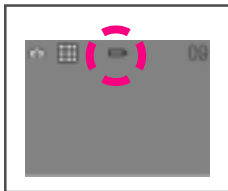
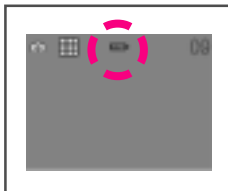

## Modes

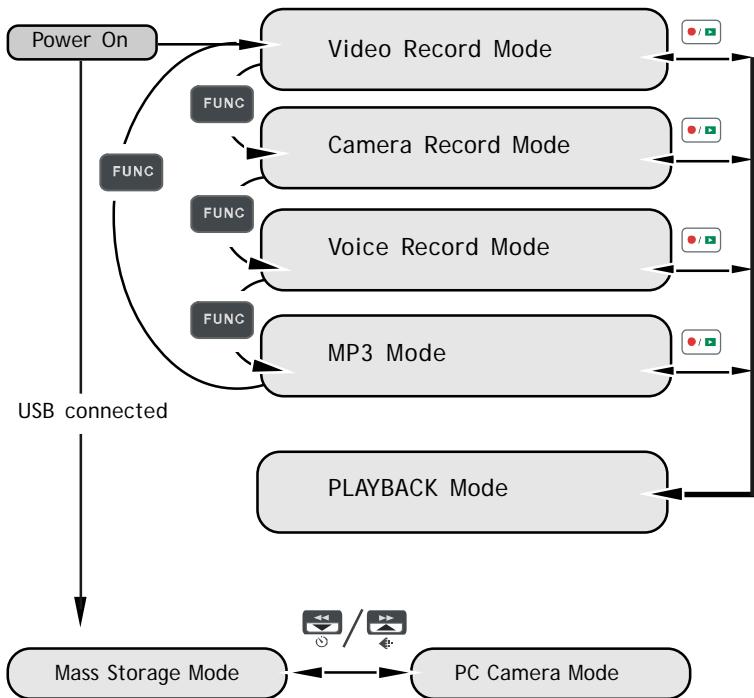



## Modes-continued

---

### Video Mode/Camera Mode/Voice Mode/MP3 Mode/PLAYBACK Mode

There are four main modes and PLAYBACK mode in this Digital Video. The four main modes are Video Mode, Camera Mode, Voice Mode and MP3 Mode.

- 1.Video Mode: take moving videos with sound
- 2.Camera Mode: take still pictures
- 3.Voice Mode: record voice messages.
- 4.MP3 Mode: listen to MP3 music.

You can switch among these four modes by pressing . By pressing , you can switch to PLAYBACK mode to review your videos, pictures and voice messages. Video Mode/Camera Mode/Voice Mode shares the same PLAYBACK mode. You can switch back to the previous mode by pressing  again.



## Modes-continued

Connected to PC(Mass Storage Mode/PC Camera Mode)

**NOTICE:** For Windows 98 users, YOU MUST INSTALL THE DRIVERS first before connecting the unit to the PC.

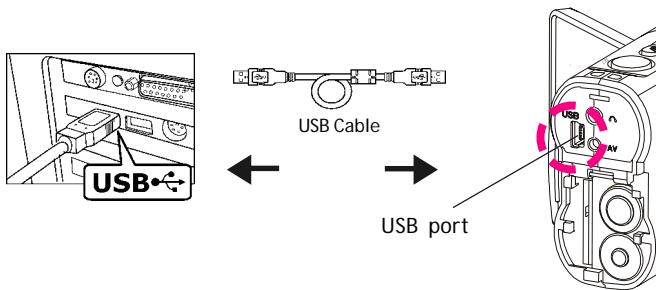

### Using Console (Not Available for MAC)

By connecting your Digital Video recorder to a computer, the Console opens. Meanwhile your Digital Video recorder switches to Mass Storage, too. You may choose either to transfer the camera data through the Console program or through Mass Storage Mode.

## Modes-continued

**NOTICE:** Windows 98 users must first install the drivers on the PC before connecting the DC500.

### Mass Storage Mode

Connect your Digital Video recorder to a computer, it will turn to Mass Storage Mode. In Mass Storage Mode, your Digital Video recorder acts exactly like a hard disk. That means you can access it via the Windows user interface. You can copy, move or delete files (pictures, movies, voice messages or MP3 music) exactly the way you manipulate files under Windows user interface.

#### Note:

1. Please do not copy any files into the DCIM folder of your Digital Video. Otherwise it may cause Digital Video instability or unit might crash.
2. Remember to copy the MP3 files into the MP3 folder of your Digital Video.

### PC Camera Mode

You can connect this Digital Video Recorder to a computer with its supplied USB cable and use it as a PC camera.

After USB connecting, the screen will show as below.

By pressing  , it will turn to PC Camera Mode. With a compatible video capture program (Not Supplied), you can capture movies.

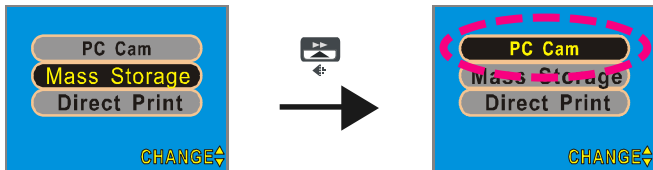

## Taking Movies

### Taking Your First Movie

1 Press Power

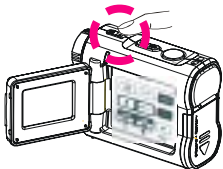

2 Switch to Video Mode

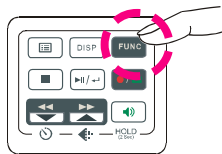

2 Slide Zoom-in or Zoom-out to frame your picture

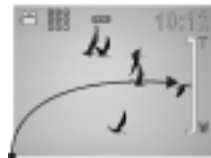
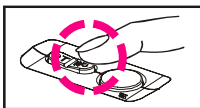
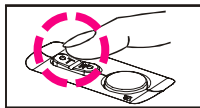

Zoom in or Zoom out

3 Press Shutter to start recording

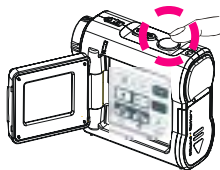

4 Press Shutter again to stop

## Taking Movies-continued

### The recording timer

While you're filming, the recording timer will be displayed on the LCD.

Before Recording



Total estimative recordable time

While Recording



The recording time

## Video Out

### Video Out

This Digital Video can output analog video to a home TV set. To configure the Digital Video, please refer to the section NTSC/PAL. (Page 32)



## Taking Pictures

### Taking Your First Picture

1 Press Power

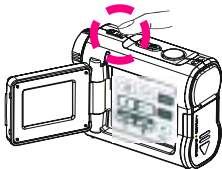

2 Switch to Camera Mode

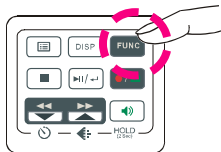

3 Press Zoom-in or Zoom-out to frame your picture

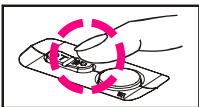
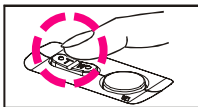

Zoom in or Zoom out

4 Press Shutter to take a picture

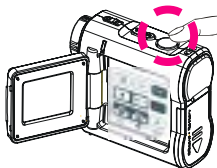

## Taking Pictures-continued

---

### The Picture Counter

You can see the picture counter displayed on the top right corner of your LCD. First, it will show the number of the total recordable files of this unit.

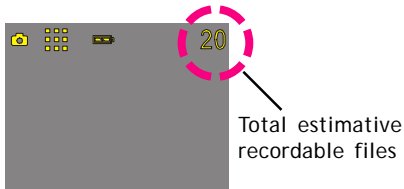

## Recording Voice Messages

### Recording Your Voice Messages

1 Press Power

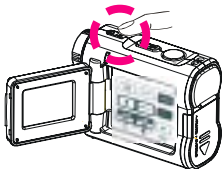

2 Switch to Voice Mode

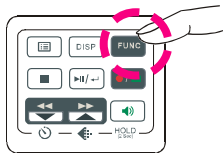

3 Press Shutter to start recording

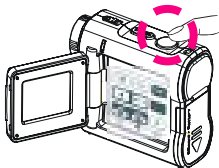

4 Press Shutter again to stop

## Recording Voice Messages-continued

### The recording timer

While you are recording voice messages, the recording timer will show on the top right corner of your LCD.

Before Recording

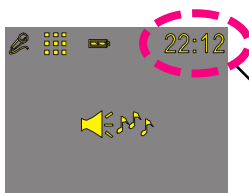

Total estimative recordable time

While Recording

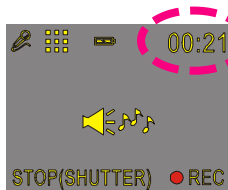

Total recording time



# Listening To MP3 Music

## Listening To MP3 Music

1 Press Power

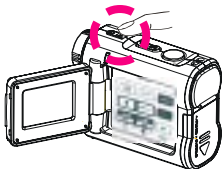

2 Switch to MP3 Mode

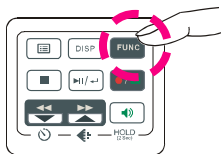

3 Press BACK or NEXT to select one track

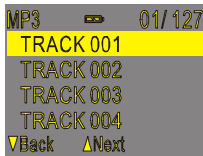
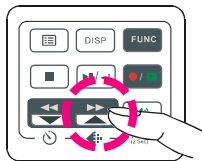
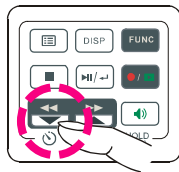

4 Press  to play MP3 music

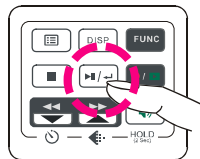

## Listening To MP3 Music-continued

5 Press  to pause



6 Press  to stop

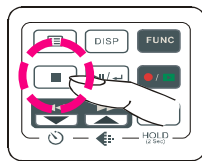

### MP3 information

The title of the selected track

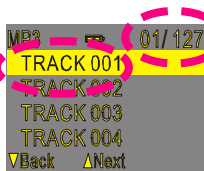

The track number/  
The total tracks

# Basic Playback for VIDEO / CAMERA / VOICE

## Basic Playback

- 1 Switch to PLAYBACK mode

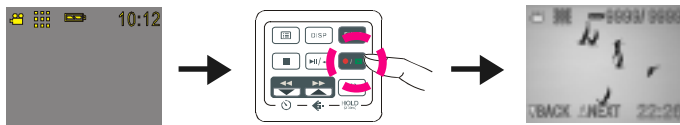

- 2 The information of the selected file will show on the LCD.

The Mode of the selected file

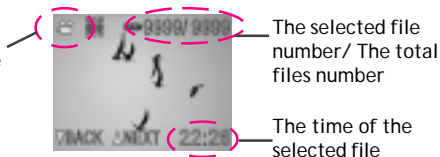

- 3 Press BACK or NEXT to navigate

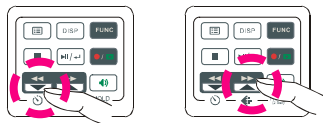

## Basic Playback-continued

The following step only works in Video and Voice files.

- 4 Press PLAY to start



- 5 Press PLAY again to pause



- 6 Press NEXT or BACK to fast-forward or fast-backward

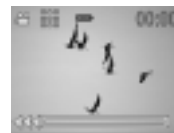

- 7 Press STOP to stop

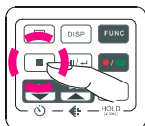

## Advanced Playback

Preview in Multiple view/Single view or Hide the information

- 1 Press **DISP** to preview in Single view

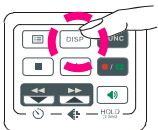

- 2 Press **DISP** again to hide the information

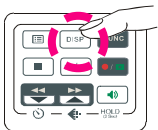

- 3 Press **DISP** again to preview in Multiple view

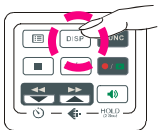

## Advanced Playback-continued

### Quick Search (Back/Next)

1 Press  for a second to Quick Search backward

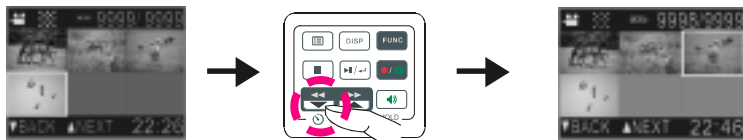

2 Press  for a second to Quick Search forward

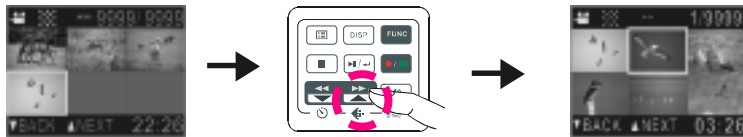

## Changing the Quality Setting

### Video Record Mode

You can change the movie's quality setting whenever you want.

1. In Video Mode, press the  button.
2. The LCD will display your current quality setting on the top left corner. "📺" is fine quality, "📺" is normal quality and "📺" is economic quality.



Fine quality  
640x480



Normal quality  
352x288

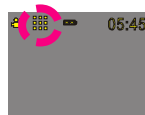

Economic quality  
320x240

### Camera Record Mode

You can change the picture's resolution setting whenever you want.

1. In Camera Mode, press the  button.
2. The LCD will display your current picture's resolution setting on the top right corner. "📺" is fine resolution, "📺" is normal resolution or "📺" is economic resolution.

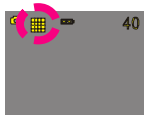

Fine resolution  
2336x1752  
(Hardware Enhanced)

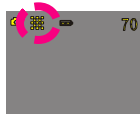

Normal resolution  
2048x1536

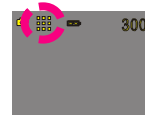



Economic resolution  
1024x768

## Changing the Quality Setting-continued

### Voice Record Mode

You can change the quality setting of voice messages whenever you want.

1. In Voice Mode, press the  button.
2. The LCD will display your current quality setting on the top left corner. "  " for standard quality, "  " for Long Time.

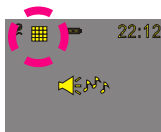

Fine quality



standard Time



## Using Self-Timer (for Video and Camera mode)

This Digital Video Recorder has a built-in 10 second self-timer.

**1** Press Timer

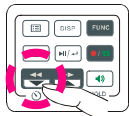

**2** Press Shutter to start

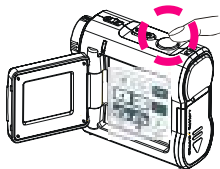

**3** The timer starts to count down from 10 seconds.

This icon will blink during count-down.



The count-down number

(Note: You could press any button to cancel self-timer during the count-down.)

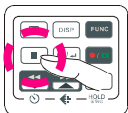

## Using Guide Line/The LCD Display

### Using Guide Line (for Video mode and Camera mode)

You can use guide line while taking movies or pictures. In Record Mode, press the **DISP** button, the guide line will show on the LCD screen.

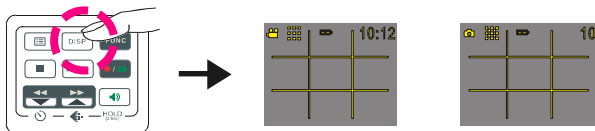

### The LCD Display

To save energy, the unit allows you to switch off the LCD panel.

For Video and Camera mode (While pressing the **DISP** button repeatedly)

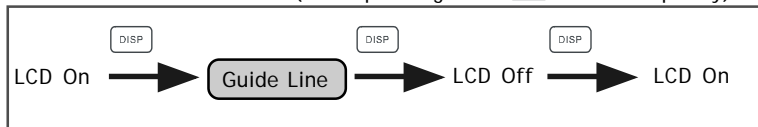

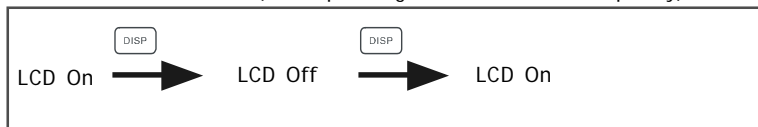

For Voice and MP3 mode (While pressing the **DISP** button repeatedly)





## Using Hold

### Using Hold (Press 2 Sec.)

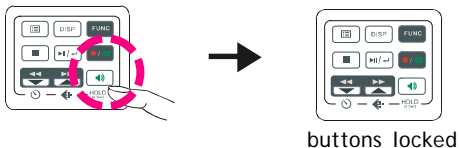
By pressing  for 2 seconds, the buttons on the panel will be locked. The buttons on the panel will not function while in HOLD. To cancel the HOLD function, press  for 2 seconds.



## Volume Adjust

You can adjust playback volume by using  or  after pressing the HOLD button for 1 second.

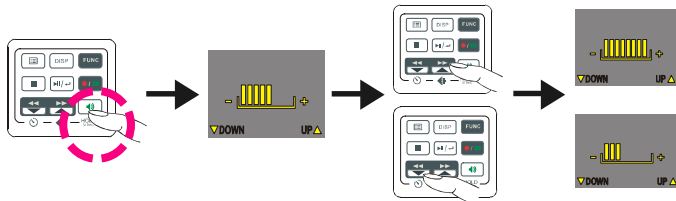

## Attention Icon

---

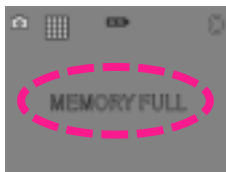

### Memory Full

If your Digital Video's memory card is full, you can not take any new movie, picture or voice message.

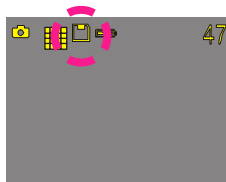

### Memory Card Indicator

**NOTICE:** The internal 32MB memory and the external memory card can not be used together. Once an external card is inserted the internal memory is not used.



### Card Lock

If you insert a SD memory card with the lock feature on, you will see a card lock icon on the LCD screen. (Only if you turn on the security lock of a SD card, there will be a card lock icon.)

## Menu

- 1 To access the MENU options Press 

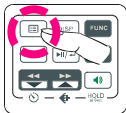

- 2 Press NEXT or BACK to move between the selected items

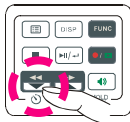
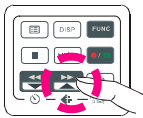

- 3 Press  to change

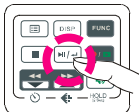

- 4 Press  to exit

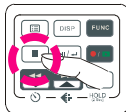

(Refer to following pages for further details)

## Menu-continued

---

### **Flash Light ON/AUTO/OFF** (for Camera mode)

The built-in flash light lets you take a picture in poor lighting conditions whether it is in the daytime or at night. If you choose Flash Light ON, the icon will appear on the LCD screen.

### **Digital Effect** (for Video and Camera mode)

This Digital Video offers four options to customize your movies and pictures. The four options are OFF (no effect), SEPIA, B&W and MOSAIC.

### **Night Shot ON/OFF** (for Video and Camera mode)

Night Shot is long time exposure to let you take a movie or picture at night or in dim light. If you choose Night Shot ON, the icon will appear on the right corner of the LCD screen. (use tripod as image will become blurry with movement)

### **Quick Review ON/OFF** (for Camera mode)

You can have a quick review on your pictures. If you choose Quick Review ON, the image will appear on the LCD screen.

### **Attach Voice ON/OFF** (for Camera mode)

You can attach voices on your pictures. If you choose Attach Voice ON, the icon will appear on the LCD screen.

NOTE:

Taking a picture with Attach Voice ON

After taking a picture with Attach Voice ON, "ATTACH VOICE!" will appear on the center of the LCD screen. Press SHUTTER to start to record the voice

## Menu-continued

message. Press SHUTTER again to stop the recording. Press  to exit.



### **Information ON/OFF** (for Video and Camera mode)

You can choose show the information or hide the information.



### **Attach Date ON/OFF** (for Camera mode)

If you choose Attach Date ON, date will be added on the picture that you recorded.

### **Date**

You could set the correct date for your unit. Press the **PLAY/ENTER** to select and **BACK** or **NEXT** to make changes. Press **PLAY/ENTER** again to move to the next section

### **Time**

You could set the correct time for your digital video. use above procedure to make edits

## Menu-continued

### Beep On/OFF

If you choose Beep On, there will be beep sound when you press the button. If you choose Beep Off, there will be soundless when you press the button.

### Auto-Off ON/OFF

Under Auto-Off, if you leave your Digital Video unused for certain times, this Digital Video will be auto-off. There are three options: 1 minute, 2 minutes and 5 minutes. (Note: If you set Auto-off ON for 2 or 5 minutes; LCD will be off first after 1 minute.)

### NTSC/PAL

NTSC/PAL are two incompatible analog TV signal formats. You can toggle between NTSC and PAL to your TV set's preference.

**NTSC:** North America and Japan

**PAL:** U.K. and Germany, France, Russia, certain European and African countries

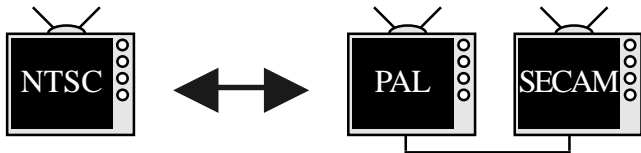

### 50Hz/60Hz

Match up with the frequency of the main power supply in your country.

Please refer to the following figures:

**50 Hz:** Europe, P.R.C., Hong kong, Australia, New Zealand and South Africa.

**60 Hz:** America, Canada, Taiwan, Japan, and Korea.



## Menu-continued

### Slide Show

You can choose to playback your movies, pictures, voice messages or MP3 in Slide Show. The Slide Show playback time is 5 seconds for each movie, picture, voice message or MP3.

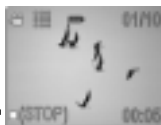

To exit, press STOP.

### Repeat ON/OFF (only for MP3 files)

You can choose to playback your MP3 repeatedly. If you choose to Repeat One, the selected track will playback repeatedly. If you choose to Repeat All, the whole tracks will playback repeatedly.



repeat one



repeat all

### Rotate ON/OFF (only for image files)

You can choose to rotate your pictures on your Digital Video. Pressing , you can rotate the picture every 90 degree in counter-clock direction.



## Menu-continued

### ☒ Del One/ ☒ Del ALL

You can choose to delete one file or all files. Press **[M/+]** to confirm.

Otherwise, press **[■]** to exit.



Yes



No

### **F** Format your Memory Card

If you want to erase all movies, pictures, voice messages, MP3 and other files, you can select FORMAT under the menu and press **[M/+]** to wipe out the memory completely. If you want to keep your memory contents, press

**[■]** to exit.

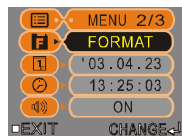

Yes

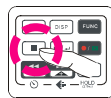

No

## Specifications

---

	<u>Digital Still Camera</u>	<u>Digital Camcorder</u>
<b>Resolution:</b>	Fine: 2336 x 1752 (Hardware enhancement) Normal: 2048 x 1536 Low: 1024 x 768	Fine: 640 x 480 (Hardware enhancement) Normal: 352 x 288 Low: 320 x 240
<b>Image Sensor:</b>	3.1 Mega CMOS Sensor	
<b>Digital Zoom:</b>	4X	
<b>Digital Effects:</b>	B&W / Sepia / Mosaic	
<b>Display:</b>	1.5" color TFT LCD	
<b>Internal Memory:</b>	32 MB	
<b>External Memory:</b>	SD / MMC (32MB to 1GB)	
<b>File Format:</b>	JPEG/ASF(MPEG4 Compatible)/MP3/WAV	
<b>Lens:</b>	Fixed (6 Glasses Lens) / 9 mm (Equivalent 49 mm for 135 camera)	
<b>Interface:</b>	USB / AV out / Earphone	
<b>Self-timer:</b>	10 seconds delay	
<b>Exposure Mode:</b>	Auto	
<b>White Balance:</b>	Auto	
<b>Flash Light (Mode):</b>	SCR type (On / Auto / Off)	
<b>Microphone / Speaker:</b>	Built-in	
<b>Television System:</b>	NTSC / PAL	
<b>Shutter Speed:</b>	1/15 to 1/2500 second	
<b>Power / Battery :</b>	1.5V AA alkaline battery x 2	
<b>Dimensions (LxHxD):</b>	3.54 x 2.65 x 1.57 Inches	
<b>Weight:</b>	110g (battery not included)	

<b>System Requirements:</b>	Pentium 500 MHz processor or higher Microsoft Windows 98SE/Me/2000/XP Available USB port Media Player 7 (Recommended Media Player 9) Super VGA card and color monitor CD-ROM or DVD-ROM drive At least 128 MB RAM 200MB available HD space
<b>Mass Storage:</b>	Windows, Mac, Linux
<b>PC Camera Driver:</b>	Win98se, Me, 2000, XP

## USB device Unplugging Notice:

If you want to unplug the Digital Video from your computer, be sure to stop the device before hand. To stop the DC500, follow the steps below:

### Remove from PC: (For Windows Me/2000/XP)

1. Click on the device icon " " located on the taskbar. Select the device you want to stop (e.g. 'Stop USB Mass Storage Device - Drive(E:)').
2. Follow the on-screen instructions to safely remove the Digital Video.

### Remove from Mac: (For Mac OS 9.X and 10.1 above )

1. Select the Digital Video icon (Shown as 'NO\_NAME' or 'untitled' drive) on the desktop.
2. Drag and drop the drive to the Trash.

## Troubleshooting:

PC does not see UNIT

- 1) Power on unit
- 2) connect unit to PC via the USB (Verify LCD displays Mass Storage)
- 3) Open 'MY COMPUTER' and verify if there is a drive called "Removable Disk" (ex Removable Disk (E:)).
- 4) Open the 'Control Panel' and double click the 'SYSTEM' icon (Start/ settings/Control Panel (Win98) - Start/Control Panel (Win2000 and XP)
- 5) Select the 'DEVICE MANAGER' tab. (In windows 2000 and XP you first must select 'HARDWARE' then 'DEVICE MANAGER')
- 6) Look for a **YELLOW EXCLAMATION POINT (!)**. This item may be located under the 'OTHER DEVICE' category. Click the + sign to expand.
- 7) Right click and **UNINSTALL** or **DELETE** this item. (repeat steps 6&7 for each item)
- 8) Press **F5** on your keyboard and the screen will flicker and come back to the last screen. Verify the yellow Exclamation did not return.
- 9) remove the unit from the USB cable.
- 10) install and complete the driver installation from the supplied CD-ROM.
- 11) repeat steps 1 and 2.

## HOW TO COPY FILES FROM THE UNIT TO YOUR COMPUTER

- 1) power on the unit
- 2) connect the unit to the PC via the supplied USB cable
- 3) verify the **MASS STORAGE** is displayed on the LCD screen
- 4) Open '**MY COMPUTER**' and look for the removable storage drive. (ex. **REMOVABLE STORAGE (e:)**) (NOTE: the internal memory and the external memory will have 2 separate drives created)
- 5) Double click on one of the **REMOVABLE STORAGE** drives.
- 6) Double click on the **DCIM** folder
- 7) Double click on the **100MEDIA** folder
- 8) Use standard Copy and Paste techniques to copy the files to a location on your computer. (see page 39 for basic windows commands)

## HOW TO COPY MP3 FILES TO YOUR UNIT

- 1) power on the unit
- 2) connect the unit to the PC via the supplied USB cable
- 3) verify the **MASS STORAGE** is displayed on the LCD screen
- 4) Open '**MY COMPUTER**' and look for the removable storage drive. (ex. **REMOVABLE STORAGE (e:)**) (NOTE: the internal memory and the external memory will have 2 separate drives created)
- 5) Double click on one of the **REMOVABLE STORAGE** drives.
- 6) Double click on the **MP3** folder. (If there is no **MP3** folder disconnect the unit from the USB and power up the unit and access the **MP3** mode to create the folder automatically.
- 7) Copy your **MP3** files from your computer to this folder, using standard Copy and Paste windows procedures. (see page 39 for basic windows commands)

*See the Quick Guide for more detail*

## BASIC WINDOWS 98/2000/XP COPY AND PASTE HELP

All files and folders can be viewed and changed using Windows Explorer. (Do not confuse this with Internet explorer, a browser to view web pages). Windows Explorer can be accessed by using the right mouse button and clicking on the **START** button located on the lower left of your windows desktop and left clicking on **EXPLORER** just below OPEN.

Windows Explorer is broken into 3 sections. The **TOP** section contains the Address bar and commands. The **LEFT** section shows the folder structure and drive information. The **RIGHT** side shows the contents of the selected folder from the left side.

Below is a picture of the Windows Explorer interface. From this screen you can select the files from the **RIGHT** side and click on **EDIT** in the top left portion. **EDIT** will give you all of the commands you can do with that file (**Copy, Cut, Paste and select all**). Once you made your selection you can brown the **LEFT** section of Windows Explorer to the place where you want to execute your command by selecting **EDIT**.

