

Canon 814XL-S 1014XL-S CANOSOUND



English Edition

INSTRUCTIONS

03/14-178

Contents



Special Features	5	Remote Control	65
Basic Operations (Pictorial Outline)	8	External Power Socket	66
PRELIMINARY PREPARATIONS AND		Using Flash	67
PROCEDURES FOR NORMAL FILMING	10	SPECIAL EFFECTS WITH SOUND	68
Loading the Batteries, Checking the Power		Auxiliary Input and Mixing	73
Level, Shutter Release Lever Control, Eyesight		Pulse Synchronized Recording	74
Correction, Focusing, Zooming, Viewfinder		ACCESSORIES	77
Information, Filming Speed Dial, Shutter		Special Lens Attachments	78
Opening Angle Dial, Filming Mode Dial, Use of		Microphones	81
CCA Filter Switch, Footage Indications, AE		Chest Pod II	82
Dial, Cue Light, etc.		CARE OF THE CAMERA	83
Sound Controls and Procedures	34	Specifications of Cameras	85
SPECIAL TECHNIQUES	39	Specifications of Dynamic Microphone	
Filming Mode Dial Functions	40	DM 40R	89
Special Effects (Fade-in/Fade-out)	42		
Lap Dissolves (1014 XL-S only)	46		
Single-Frame and Timed Interval Filming	50		
Self-Timer Filming	52		
Slow-Motion Shooting	54		
Macro Filming	57		
Exposure Compensation	61		

1014XL-S/814XL-S SOUND SYSTEM

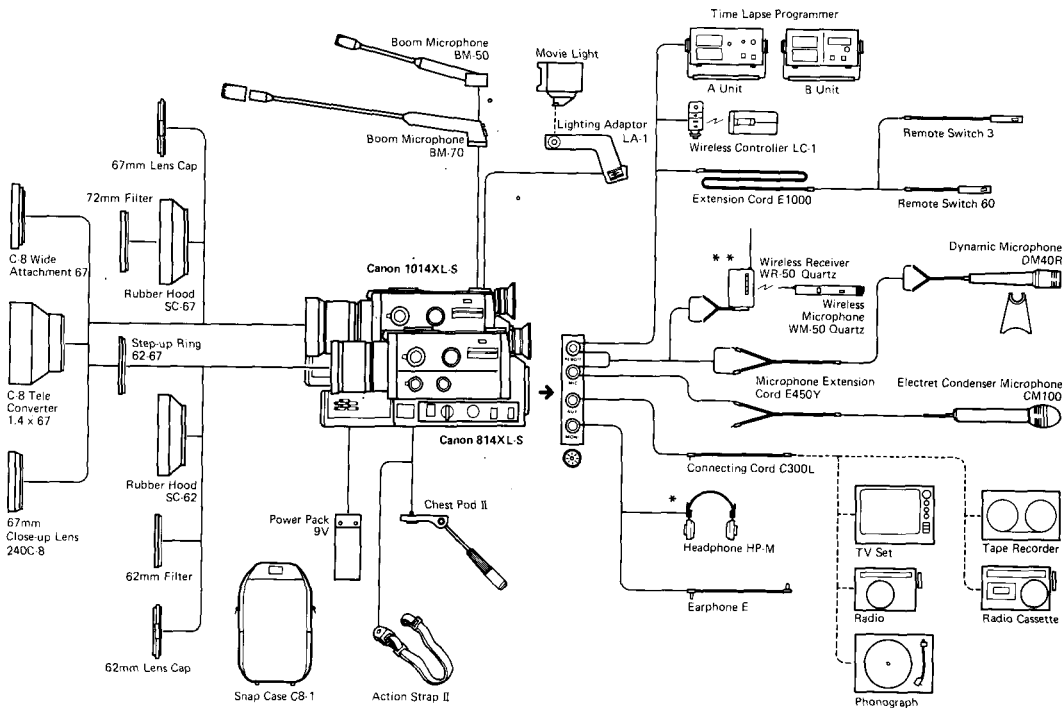

* Availability differs from area to area.

** Available only in the U.S.A.

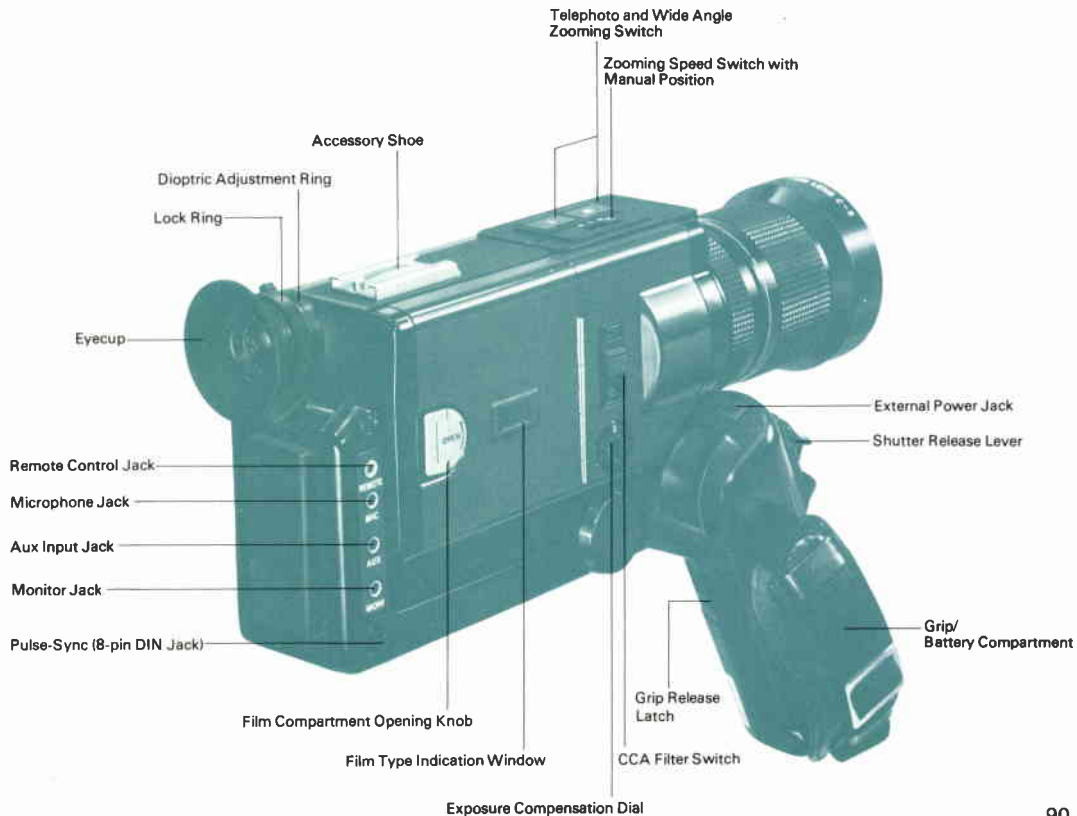

IMPORTANT—READ THIS NOTICE

As the new owner of the Canon 1014XL-S or 814-XL-S, you are in possession of one of the most advanced Super 8 cameras in the world. With such features as built-in self-timers, interval timers, fading and lap dissolve (1014XL-S only) mechanisms, they are the perfect cameras for the experienced amateur or professional while they are so easy to use that even outright beginners can easily master them for professional-quality films, whether sound or silent.

One reason for such shooting ease is their multi-functional controls and unusual, new features. Becoming completely familiar with these and camera handling will help you to enjoy the camera to the full. Once you have read the sections entitled "Preliminary Preparations and Procedures for Normal Filming", you will be able to go out and shoot with complete confidence and beautiful results.

After you have mastered the basic techniques of filming and feel ready to add some new looks to your films, read the section entitled "Special Tech-

niques" and "Special Effects with Sound". The features discussed in these sections will give you the tools you need for creating very professional special effects.

The "Accessories" section gives tips on making even fuller use of the camera, and be sure to note carefully all of the information in "Care of the Camera".

Welcome to the Canon world of movie making.

814XL-S



Shooting Mode Dial

Macro Set Button

Release Button

Distance Scale

Shutter Angle Dial

Eyepiece Shutter

Focusing Ring

Fade Lever

814XL-S



Footage Counter

Lap Dissolve Button

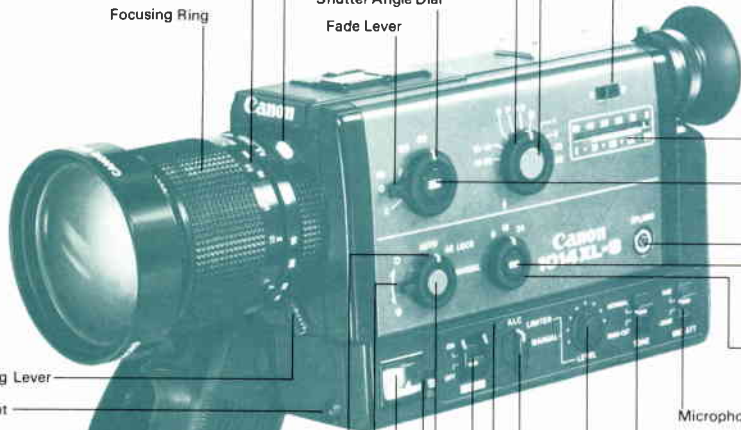

Flash Socket

Instant Slow Motion Button

Filming Speed Dial

Manual Zooming Lever

Cue Light

Microphone Attenuator Switch

Tone Control Switch

AE Dial

Volume Control Dial

Manual Aperture Lever

Recording Mode Selector Switch

Level Meter/Battery Checker

ALC Release Button

Main Switch

Battery Check Button

Auto Release Button

SPECIAL FEATURES

Compact, Quality Zoom Lens

From wide-angle to telephoto, this compact zoom lens gives a sharp image with excellent, even color balance. The built-in wide-angle macro and telephoto macro mechanisms are easy tools for high-quality close-ups.

Full-Information Viewfinder

You get what you see in this viewfinder, and it gives all the information you need and want to know for making the perfect film. In it you will find various indications showing exposure and exposure warnings, whether the aperture is being controlled manually, whether the recording level is satisfactory, how much film remains, whether the power level is too low, or the film is jammed and whether the film is near or at the end. The multi-functional END warning which is superimposed over the image in the viewfinder of the 1014XL-S, is another whole new kind of information display from the makers of the A-1.

Multi-Mode Filming

You can, of course, expect excellent results in normal sound or silent filming. These cameras are also provided with special controls for the kind of techniques which make a film truly professional in quality. The built-in self-timer gives a choice of a ten-second waiting interval with either ten or twenty seconds of filming, and there is a built-in interval timer for timed single-frame filming at intervals of one, five, twenty or sixty seconds. Another position permits regular single-frame filming. Automatic fade-in/fade-out of sound and picture, picture only or sound only are possible. And the 1014XL-S even has controls for automatic lap dissolve of both picture and sound.

Safety Mechanism

The camera is highly electronically controlled and incorporates various safety features. For instance, abnormalities in film transport or the film reaching its end get detected right away. The photographer can always grasp the situation as a warning appears in the viewfinder and si-

multaneously stops the camera.

Unique Control of Shutter Opening Angle

The camera's shutter has a variable opening angle for the most effective filming in various lighting conditions. For filming in bright conditions it can be set to 150°. The 220° opening angle is the ultimate in XL filming for dim lighting conditions. No matter what the opening angle, exposure is adjusted automatically and perfectly. Full closure of the shutter permits automatic fading.

Wide Range of Filming Speeds

If the situation calls for a filming speed other than the normal speed of 18 frames/second, you have your choice between 9 fps, 24 fps, single-frame filming and slow motion filming. The camera prevents sound filming at 9 fps, single-frames, or slow motion.

SPC Servo AE

Metering is through-the-lens; exposure control is automatic. While the wide-range, highly responsive silicon photocell

(SPC) assures perfect exposure even in dim lighting conditions, the five-bladed iris diaphragm promises excellent image quality.

Exposure Compensation and Manual Aperture Control

Even while filming with automatic exposure, it is possible to alter the aperture in 1/3 f/stops up to ± 1 f/stop for such situations as backlighting. For constant exposure in quickly changing lighting conditions there is an exposure lock mechanism. If these two controls don't cover the situation adequately, you can take complete control over the aperture.

Advanced Recording Mechanism

Anything is possible with these cameras. Canon's own automatic level control (ALC) mechanism will assure perfect recording in normal sound conditions. For those unusual situations or special effects, regular manual control or manual control with a limiter are possible and a manual volume control dial is provided. Tone and input sensitivity controls permit

absolute control over all recording factors. Input can be made by microphone, auxiliary equipment or a combination of the two. The camera is equipped with a level meter for reference in manual recording as well as ALC recording.

System Accessories

With various lens attachments, you can expand your filming range into the super wide-angle, super telephoto and close-up fields. Attaching the Wide Attachment to the 1014XL-S shortens the focal length to a mere 4.3 mm. *Microphone options include two boom microphones and a high-quality electret condenser microphone. Plus, there are filters, a headphone, a lighting adaptor, viewing aids, remote control accessories and much, much more.*

PRELIMINARY PREPARATIONS

1. Release the lock and unfold the grip.



2. Load the batteries into the grip.



3. Turn ON the main switch and check the batteries.



4. Set the eyepiece shutter to "O" (OPEN).

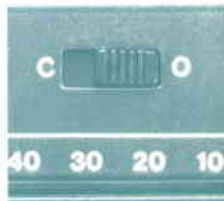

BASIC OPERATIONS

9. **SOUND**
Set all recording controls to upward positions.



10. **SOUND**
Connect the microphone and earphone.



11. Check the CCA filter switch position.

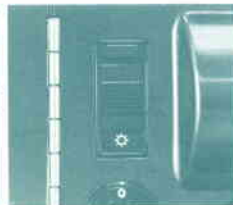

12. Zoom to telephoto and focus.



13. Compose the picture.

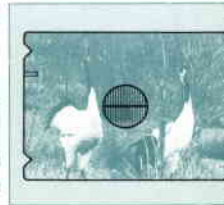

5. Adjust the camera to your eyesight.



6. Set the R/RL switch to "R".



7. Set all filming controls to upward positions.



8. Load a cartridge.



OPERATIONS

(Zoom if necessary.)

14.

Press the shutter release lever halfway. Check the exposure (and monitor the sound).

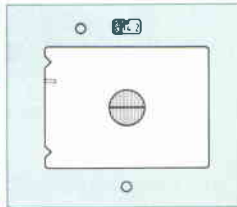
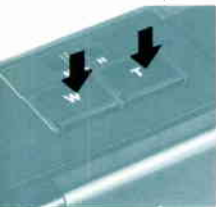

15.

Press the lever all the way for actual filming.



16.

After filming, turn OFF the main switch.

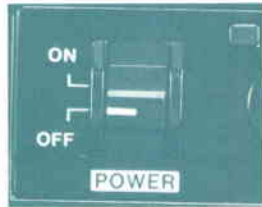

**PRELIMINARY PREPARATIONS AND PROCEDURES
FOR NORMAL FILMING**

Grip

The camera's foldable grip doubles as a battery compartment. Stored in the upward position, it should be lowered for shooting. To lower it, swing it downward, while pushing the grip release in the direction of the arrow, until it stops and locks into position. You should slide your right fingers under the grip band while shooting. Adjust the grip band to the most comfortable length for you. To fold the grip back up, push the grip release again.

Lens Cap

The lens is provided with a front cap which can be attached and removed by pressing in the tabs on both sides of the cap. To protect the lens, this cap should always be attached when not filming.

Loading the Batteries

This camera will not function without batteries. Since it is controlled electronically, batteries power all systems, including film drive, the recording mechanism and exposure control. Use six AA-size 1.5V (penlight) alkaline manganese, carbon zinc or Ni-Cd batteries. Wipe battery poles with a clean, dry cloth before insertion to avoid possible corrosion to contacts due to dirt or fingerprints.

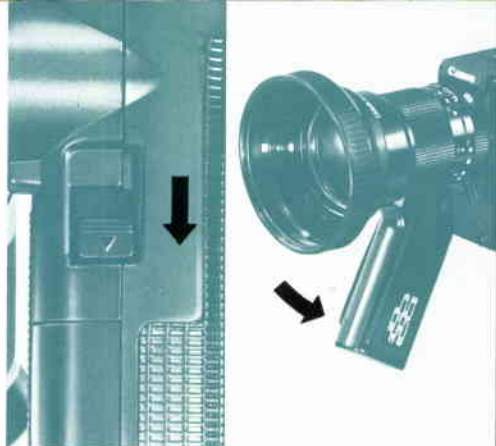

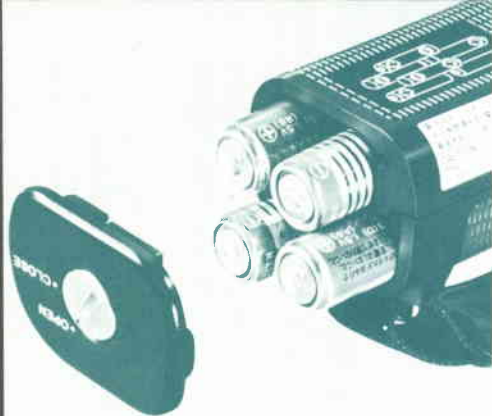

To load the batteries:

1. Using a coin or some similar object, rotate the battery chamber cover lock at the end of the grip to "OPEN".
2. Load six new batteries into the grip so that their poles are facing in the directions indicated by the diagram on the side of the grip. If the poles are not in the correct directions, reverse current may lead to battery rupture.
3. Align the positioning pins on the rear of the battery chamber cover with the corresponding holes at the end of the grip, push the cover in and rotate the cover lock to CLOSE. The cover cannot be closed if you try to attach it in the wrong direction.

Main Switch

The main switch controls the power for all camera systems. For filming, recording, checking the exposure, power zooming or doing anything else that requires power, the main switch must be set to "ON". **When not using the camera, be sure the main switch is "OFF" to prevent battery drain.** A red warning appears when the switch is at the "ON" position to remind you that you are using power.



Checking the Batteries

A fresh set of batteries should provide sufficient power to film seven sound cartridges or ten silent cartridges when filming in normal temperatures.

The batteries should be checked at the following times:

1. After replacing the batteries.
2. After loading a new cartridge.
3. When using the camera after it has been left idle for an extended period.
4. When filming in cold temperatures.

To check the power level, proceed as follows:

1. Turn ON the main switch.
2. Press the battery check button. When this button is pressed the meter needle of the recording level/power level meter moves. The position of the needle depends on the condition of the batteries as indicated in the following chart whether the camera is loaded with silent or sound cartridge.

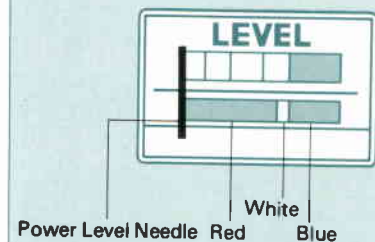

When the batteries become exhausted, a warning will appear in the viewfinder and camera operation will automatically stop. The viewfinder warning for the 1014XL-S is the word "END" which appears superimposed over the picture area. The 814XL-S's viewfinder warning consists of a red LED which lights up to the right of the picture area. These particular warnings also have other functions. For more information, refer to page 28.

When replacing batteries, replace all of them at the same time with new batteries which are all of the same type and brand. The batteries should be unloaded to prevent damage to the camera from leakage if the camera will not be used for a long time.

For recommendations concerning batteries when filming in low temperatures, see page 84.

Position of Meter Needle	Power Condition
Within blue zone	Sufficient for normal function of all systems
Within white zone	Sufficient for filming at 9 or 18 fps only
Within red zone	Insufficient for normal function of any system. Change the batteries.

Shutter Release Lever, R/RL Switch

The shutter release lever is a two-step control. Pressing it halfway gives a meter reading in the viewfinder and enables sound monitoring. Pressing it all the way starts filming and, in the case of sound film, recording. If the R/RL switch is in the R (Running) position, filming and recording will continue as long as the shutter release lever is pressed and stop when you let go of the release lever. If it is set to "RL" (Running Lock) filming and recording will start when the shutter release lever is pressed all the way and continue even when your finger is removed from the release lever. Filming will stop when the release lever is pressed again. **Do not switch the position of the R/RL switch while pressing the shutter release lever.**



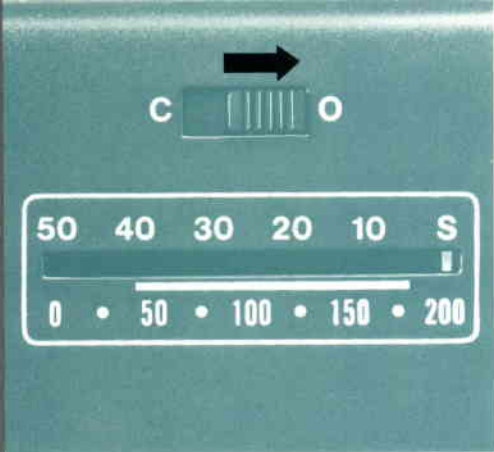

Eyepiece Shutter Switch

The eyepiece shutter switch has open (O) and close (C) positions. Normally it should be in the open (O) position. It should always be switched to "C" whenever your eye is not to the eyepiece during filming, for instance, when filming with remote control or the self-timer. Otherwise, light coming through the eyepiece could cause incorrect exposure.

Eyesight Correction

To assure good focus, the camera must be adjusted to your eyesight. To make the adjustment:

1. Set the eyepiece shutter switch to the "O" (OPEN) position.
2. Turn the eyepiece lock ring counterclockwise until the eyepiece ring can be turned freely.
3. Remove the lens cap and, while pointing the lens toward a bright object, such as the sky or a white sheet of paper, look into the viewfinder and turn the eyepiece ring until the split-image rangefinder in the center of the viewing screen becomes clear.
4. Then, being careful not to move the eyepiece ring, turn the lock ring clockwise to lock the eyepiece ring in that position.



S

200

16

COMPOSING AND FOCUSING

The subject will be recorded on film exactly as you see it in the viewfinder. The composition can be changed by zooming.

Focusing

To focus, look through the viewfinder while turning the focusing ring. The viewfinder has a split-image rangefinder focusing aid which is the horizontal line in the center of the circle. When out of focus, this rangefinder splits the subject horizontally. Turn the focusing ring until the divided subject merges to become a whole.

Focusing should be performed at the telephoto end where the subject is magnified for more accurate focus. Then zoom back to wide angle if you wish. The subject will remain in focus while zooming. If focusing is done at the wide-angle end you may find that you did not focus perfectly when you zoom to telephoto.

The closest focusing distance is normally 1.2 meters. The yellow line to the left of the 1.2 m indication on the focusing ring is for focusing in macrocinematography.

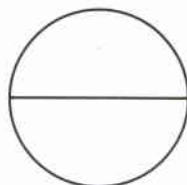

After eyesight correction

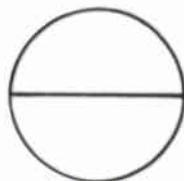

Before eyesight correction

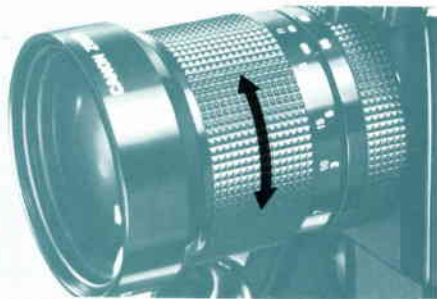

Out of focus



In focus



Zooming

Zooming allows you to change the magnification of the subject without causing any shift in focus. The lens of the 814XL-S zooms to eight times its minimum focal length, that of the 1014XL-S to ten times. Either manual or power zooming is possible.

Manual Zooming

Set the zooming speed switch on the top of the camera to "M" (Manual) where it click-stops. Push the zooming lever to the left to decrease focal length and magnification or to the right to increase focal length and magnification. The zooming lever can be extended for more convenience.

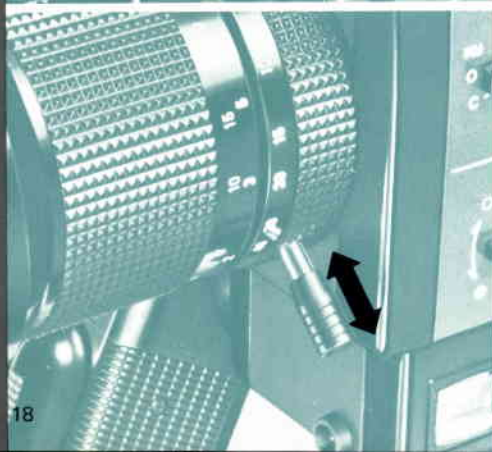

Power Zooming

Power zooming is possible only when the main switch is "ON". Set the zooming speed switch to either the "L" (low) or "H" (high) click-stop positions and press either the "W" (wide-angle) or "T" (telephoto) zooming button. Pressing "T" will cause the lens to zoom automatically towards the maximum focal length for greater magnifications. Pressing "W" will cause the lens to zoom automatically towards the minimum focal length for lower magnifications. To stop power zooming, release your finger from the zooming button. At "L" the speed is approximately nine seconds, at "H" approximately five seconds, for the full 8X or 10X zoom. **Do not set the zooming speed switch between click-stop positions.**

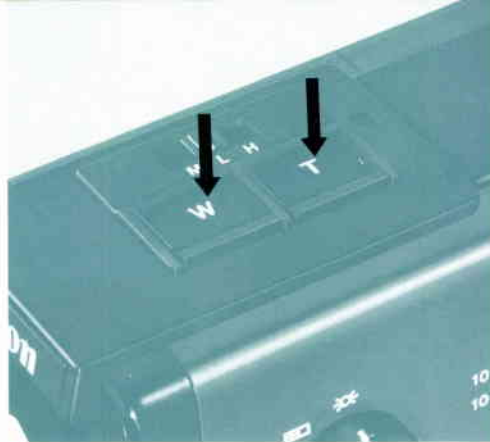

1014XL-S

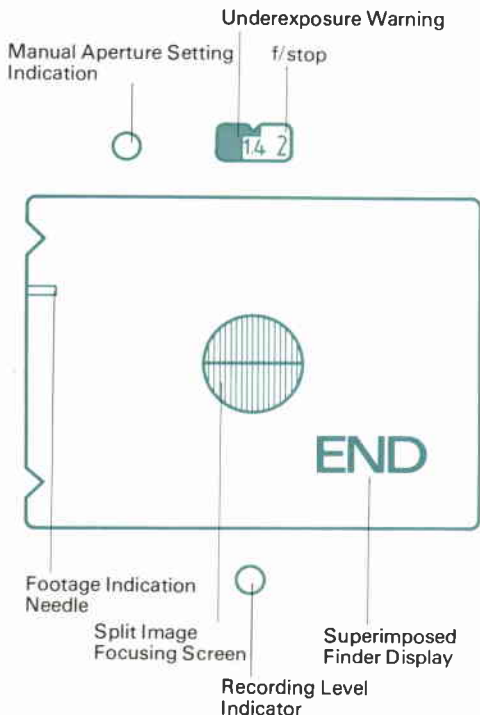

VIEWFINDER

The viewfinder gives you all the information you need for knowing if exposure is correct, if the film has reached its end or the batteries are exhausted, how much film remains, whether it is being transported correctly, whether the recording level is alright and whether exposure is being controlled manually. The viewfinders of both the 1014XL-S and 814XL-S include an aperture indication with over and underexposure warnings and a manual aperture control indication above the picture field, a footage indication on the left of the picture field and a recording level indicator below the picture field. An END warning which appears in the lower right corner of the picture field in the 1014XL-S and a red LED warning which appears to the right of the picture field in the 814XL-S complete viewfinder information. All indications except the END warning (1014XL-S) or LED warning (814XL-S) become functional (if valid) when the shutter release lever is pressed halfway and remain active during filming. The END or LED warning appears only at certain times. (See page 28)

Exposure Preview

Before filming, press the shutter release lever halfway to check the exposure. The camera-selected aperture appears in the viewfinder above the picture area. The aperture scale extends from f/1.4 to f/45. Above and to the left of f/1.4 is the red underexposure warning zone. Above and to the right of f/45 is a red overexposure warning zone. The aperture index is the triangular projection in the center of the indication. **If the aperture index does not point to either of these exposure warning zones, exposure is correct. If the index points to the red zone above f/1.4 or f/45, exposure is also still correct.**

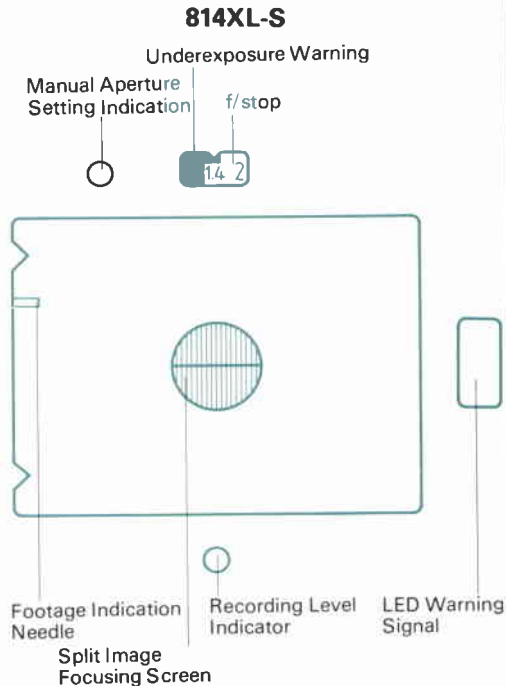



Holding the Camera

Some ways of holding the camera will cause blurred movies, so make sure the camera is held correctly. The fundamentals of holding a camera are to put your right hand through the strap and hold the grip with your index finger on the shutter release lever. Use the left hand to control the zooming switch on the top of the camera and for holding the upper part of the camera body while shooting. Press your right elbow firmly against your body to steady the camera. Keep your feet slightly apart. If you are panning, do so by turning only your upper body from side to side, without moving your lower body. The ideal, when possible, is to use a tripod and cable release device, such as Remote Switch 60, supplied with the camera, in order to avoid camera shake. And whenever removing your eye from the eyepiece, be sure to close the eyepiece shutter to prevent extraneous light from entering and adversely affecting the exposure.



Filming Speed Dial

This dial has three positions: 9 frames/second, 18 frames/second and 24 frames/second. **The normal speed for both sound and silent film is 18**

fps. At this filming speed, the shutter speed is about 1/40 sec. at a shutter opening angle of 150° or about 1/30 sec. at a shutter opening angle of 220°. **At 9 fps only silent filming is possible even if a sound cartridge is loaded.** Simply turn the dial until it click-stops at the speed you want.

Although any speed can be set, each speed has its advantages and disadvantages. If the projection speed is constant, a filming speed of 24 fps will have a slight slow-motion effect. It is considered to give slightly better quality to both picture and sound and is especially effective for filming action, panning or for smoother long shots of landscape. Its disadvantage is that the film is used up faster.

If the projection speed is constant, a filming speed of 9 fps will accelerate the subject's movement. It is useful for comical effects and for increasing the exposure time to permit filming under very poor lighting conditions. At this speed, you can film in half as much light as at the normal speed of 18 fps. Its major disadvantages are that it causes movement to be jerky and is unsuitable for sound filming.

At the center of the filming speed dial is the slow motion button. See also page 54.



***When using a tripod, make sure that its feet are rubber-tipped.**

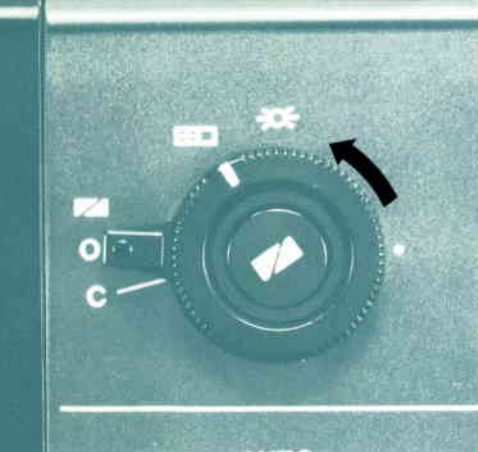

Shutter Opening Angle Dial

The camera's shutter consists of blades which form a disc shape with an opening. The angle of the opening is variable from 0° to 220° . At the position of the sun symbol ☀, the opening angle is 150° and exposure time is relatively short. At the position of the window symbol ☳, the opening is at its widest angle of 220° and exposure time is long to let more light on the film for XL filming in dim light.

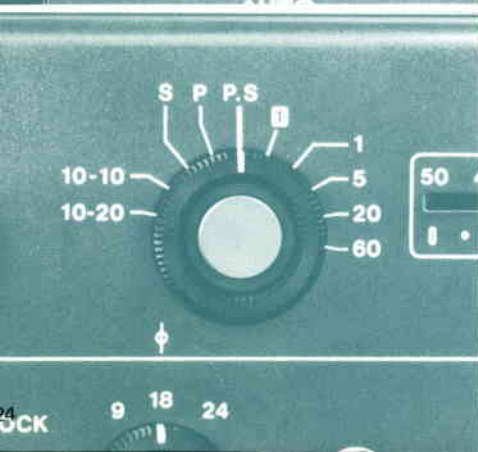

A lever around the shutter opening angle dial can be set to other symbolic positions. The "O" and "C" positions are for fading. The ■ symbol and the button at the center of the dial on the 1014XL-S are for lap dissolve.

Filming Mode Dial

The normal setting for this dial, whether for sound or silent filming, is the "P.S" position. This position allows normal filming and, when used with various other controls, automatic fade-in/fade-out and lap dissolve of both picture and sound. (See pages 40–41 for more details.)

Loading the Film

The camera accepts Super 8 sound or silent cartridges which have film speeds ranging from ASA25 to ASA400 for tungsten (A type) film or from ASA16 to ASA250 for daylight type film. For filming outdoors in daylight, ASA40 film is recommended. ASA160 film is recommended for indoor and night filming.

To load the film:

1. Unfold the film compartment opening knob and rotate it in the direction of the arrow to open the film compartment cover.
2. Insert the cartridge, front end first, with its label facing you as indicated by the diagram inside the film compartment.
3. Close the back cover, pushing it in, and rotate the opening knob to its former position. The cover is now locked shut.

When unloading the cartridge, lift it out back end first.

The film speed is automatically set on the camera as soon as the cartridge is loaded. The cartridge label can be seen through the small window of the film compartment cover for easy confirmation that film is loaded and of the film type.

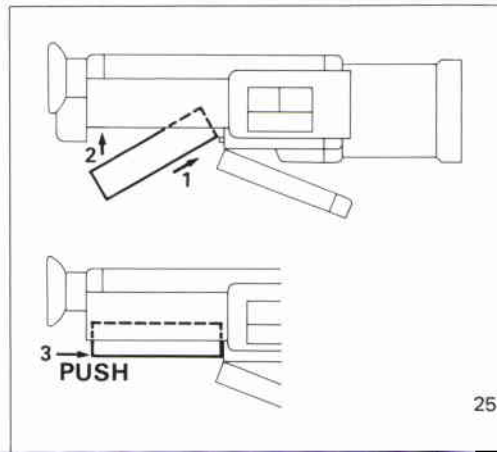
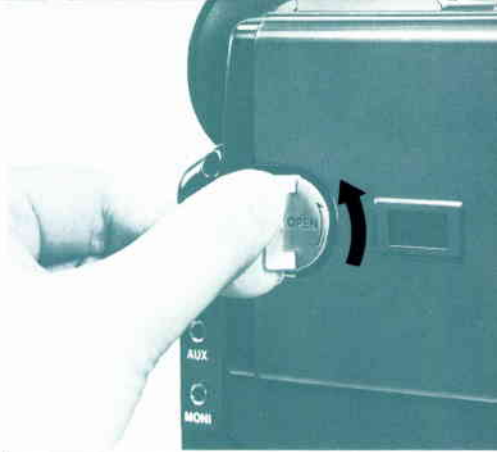

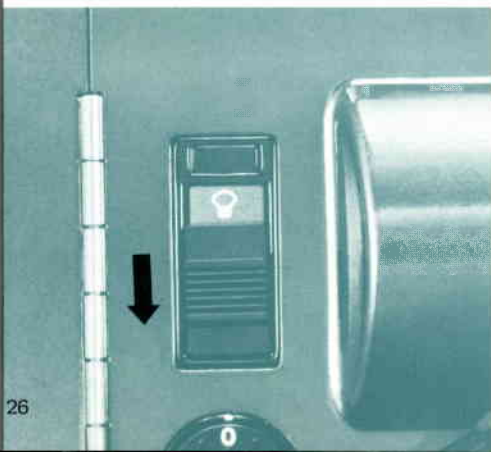



CCA Filter Switch

A Super 8 camera is designed to be able to shoot in daylight conditions when tungsten film is loaded. Tungsten film is designed to be used in artificial lighting. When this film is used in daylight, a CCA filter is necessary to correct the color balance or the film may have a bluish tinge. The camera has a built-in CCA filter which is controlled by the CCA filter switch. **When filming with tungsten film in daylight or with artificial lighting which has the same color temperature as daylight, this switch should be set to the position of the sun symbol ☀ .** At this position the CCA filter is in place. **When filming with tungsten film in artificial tungsten lighting, push the switch down while pressing in the filter switch lock button.** This sets the switch to a bulb symbol 💡 which indicates that the filter has been moved out of the optical path. To reset the switch to the sun symbol for daylight filming, simply push it back up. **The switch may be in either position when daylight (Type G) film is loaded.**

Use of CCA Filter

Film Type	CCA Filter	Daylight Filming	Artificial Light Filming
Type 'A' for tungsten light	Built-in		
Type 'G'	Automatically removed	May be set to either position	

Footage Indications

The amount of film transported can be checked on both the inside and outside of the camera. The top scale of the footage counter on the side of the camera indicates the amount of film in feet that has already been exposed. The lower scale indicates how much filming time remains in seconds at a filming speed of 18fps.

The needle of the footage indicator inside the viewfinder descends as film is used. Keep an eye on this indicator while filming.

The footage counter returns to "S" and the footage indicator needle to the top index automatically whenever a cartridge is loaded or removed. The same is true when an already partially exposed film is loaded in which case these indications will no longer be reliable.



Indicating finished cartridge

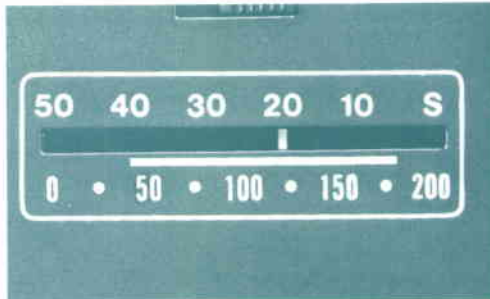

Indicating footage exposed

1014XL-S

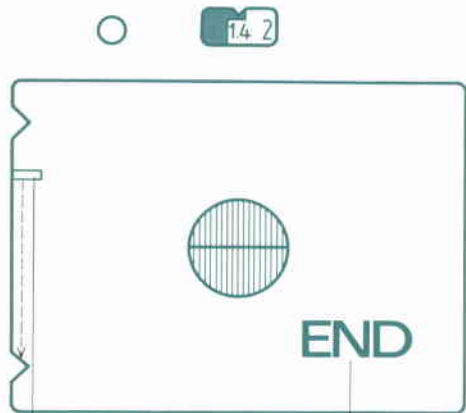

Footage Indication
Needle

Superimposed
Finder Display

Film Transport and Film End Warnings

An END warning will appear superimposed over the lower right corner of the picture field in the viewfinder of the 1014XL-S and a red LED warning to the right of the picture field in the viewfinder of the 814XL-S to indicate battery exhaustion. These same indications also warn of faulty film transport and film end. They give these warnings as follows.

The END warning (1014XL-S) or red LED (814XL-S) will blink on and off twice per second in the following situation:

1. Two feet before the end of the cartridge.

This warning will not occur if the cartridge was reloaded after having already been partially exposed.

The END warning (1014XL-S) or red LED (814XL-S) will come on and glow steadily and camera operation will stop automatically in the following situations:

1. When the cartridge is finished.
2. If the film jams in the cartridge.
3. When battery power becomes too low.

Since the warning will glow steadily in several situations, pinpoint the reason by taking the following steps in this order:

1. Check the footage counter as well as the footage indication needle to the left of the picture field.
2. If the footage counter indicates that the cartridge is finished, replace the cartridge.
3. If the footage counter indicates that unexposed film remains, check the batteries. If they are weak, change them.
4. If the footage counter shows remaining footage and battery power is sufficient, remove the film magazine, being careful not to tear the film in case it is stuck. Be especially careful in the case of film jam at the bottom of a sound cartridge. Once the cartridge is removed, wind the spool manually to take up the slack by turning the core two or three times clockwise. Tap the cartridge lightly on a flat surface and then reload it into the camera. Normal function usually resumes.

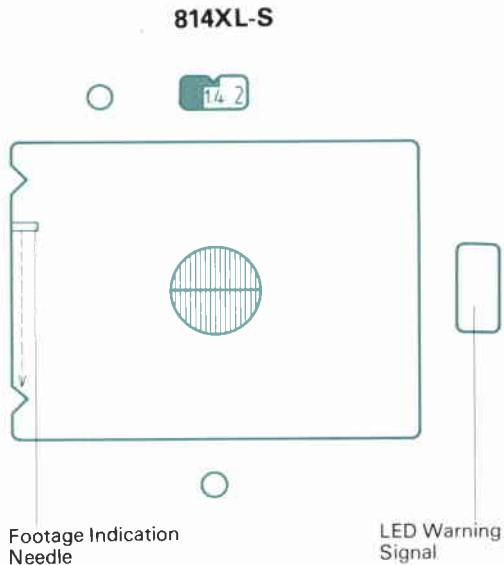

EXPOSURE

An image is formed on the film frame when the semi disc-shaped rotating shutter exposes the frame to the light coming through the lens. When the shutter rotates to cover the frame, the film is being transported by the film drive mechanism to the next frame. The length of time that the light is allowed to strike the film depends on the filming speed and the shutter opening angle. The amount of light that is allowed to strike the film is controlled by the diaphragm which consists of blades which open and close to certain size apertures (openings). These apertures are given numerical values called *f/stops*. A smaller number indicates a larger aperture, which lets more light in, and is called a large *f/stop*. A large number indicates a smaller aperture and is called a small *f/stop*.

AE Dial

This is an AE (automatic exposure) camera. Once you set the filming speed and the shutter opening angle, the camera automatically controls the aperture for correct exposure. **In order for this to take place, the exposure control dial must be set to AUTO which is its normal position.** It locks at this setting. The



AE LOCK and MANUAL settings of this dial as well as the manual aperture lever and settings to the left of AUTO permit manual control of the exposure in unusual filming conditions and are explained in more detail on page 63–64. Manipulating the manual aperture lever while this dial is at AUTO will not cause a change in aperture.

To remove the dial from the AUTO position, turn it clockwise while pressing the release button at its center. The dial turns freely between the AE LOCK and MANUAL positions.

Exposure Confirmation

If the aperture index points fully to the underexposure zone, you have several alternatives. Take one or any combination of the following steps if possible:

- 1) If the shutter opening angle dial is set to the sun symbol, switch it to the window symbol.
- 2) Switch to a slower filming speed if possible.
- 3) Switch to a higher speed film.

If, after taking these steps, the index still points to the underexposure zone, you have no alternative but to add light.

If the index points to the overexposure warning zone, take one or any combination of the following steps if possible:



- 1) If the shutter opening angle dial is set to the window symbol, set it to the sun symbol.
- 2) Switch to a faster filming speed.
- 3) Switch to a lower speed film.
- 4) Attach a neutral density (ND) filter optionally available.

If these measures won't do, subdue the light. The manual exposure control indication appears in the viewfinder when the aperture is being controlled manually. For further details, see page 64. **During filming by remote control, for instance, when using the remote release button on Microphone DM 40 R, no exposure indication is given in the viewfinder.** If you wish to check the exposure, press the shutter release lever halfway.

Cue Light

During filming, the cue light at the front of the camera blinks at the rate of eight flashes per second to warn your subject that he is "on stage".

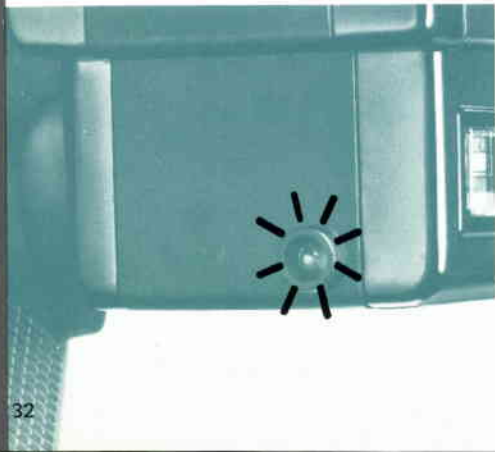

Rubber Hood

Use hood (supplied item) for preventing image-deteriorating ghost and flare, particularly when sunlight is coming directly into the lens.

Step-up Ring 62-67

When using special lens attachments (pages 79-80) on the 814 XL-S, it is necessary to use Step-up Ring 62-67 (supplied item for the 814XL-S).

Filming a TV Screen

To take a TV screen, aim so that only the screen fills the viewfinder. Set the shutter angle dial to the window (☐) symbol, the CCA filter switch to the sun (☀) symbol, and the filming speed dial to 18. Take a reading for correct exposure at the AUTO setting of the AE dial and lock that reading at the AE LOCK position (page 63) prior to shooting. Using the earphone jack provided on the TV is recommended over recording with a microphone (page 73). Incidentally, in shooting a TV screen, diagonal scanning lines occasionally come out in the picture.

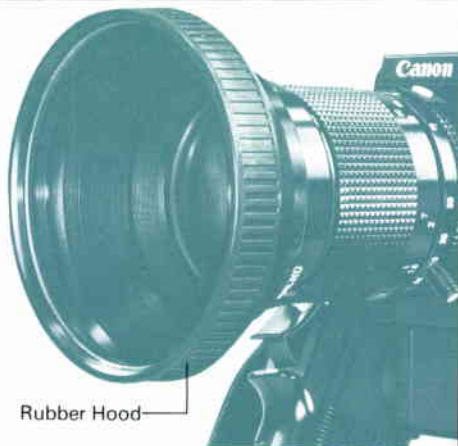

Rubber Hood



Step-up Ring 62-67



SOUND CONTROLS AND PROCEDURES

There are many ways to record and control the sound with this camera. This section deals with the basic techniques. The four sound controls are conveniently arranged in a row at the bottom of the left side of the camera. For more details, see pages 69—72.

1 Recording Mode Dial

This dial has three positions: ALC (Automatic Level Control), LIMITER and MANUAL. Ordinarily this dial should be set to ALC where normal sounds are automatically recorded at the correct volume. The dial automatically locks at this position.

The LIMITER and MANUAL positions are for manual sound control for use under unusual sound conditions or for special effects. To set one of these positions, turn the recording mode dial from ALC while pressing the recording mode dial lock button. The dial turns freely between LIMITER and MANUAL. The volume control dial to the right of the recording mode dial is for controlling the volume when the recording mode dial is set to LIMITER or MANUAL.



2 Tone Control Switch

This switch is used for controlling the sound quality. Its two positions should be set according to the background noise situation.

3 Microphone Attenuator Switch

This switch is used to change the microphone input level. In most cases it should be set to 0dB, a position in which it locks.

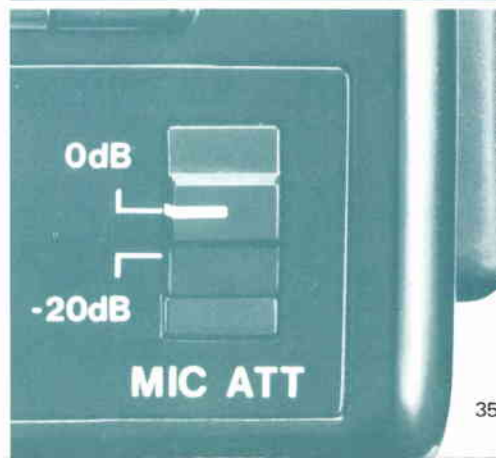
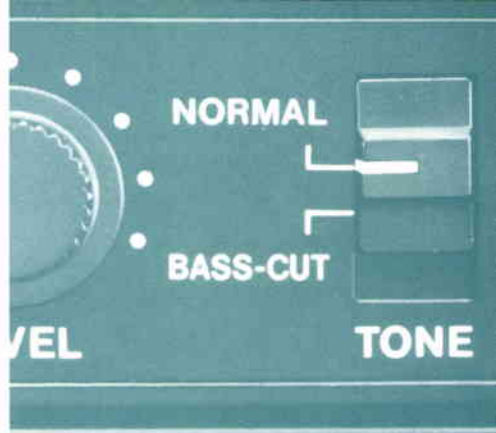



Input and Monitoring

Normally sound is fed into the camera by means of a microphone. The camera is provided with Dynamic Microphone DM 40 R. This microphone has two plugs, one for the MIC socket and one for the REMOTE socket. When the corresponding plug is plugged into the REMOTE socket, filming can be started by pressing either the shutter release lever on the camera or the remote release button on the microphone. If you use the remote release button, filming will continue as long as the button is pressed and will stop when you withdraw your finger from the button even if the R/RL switch is at "RL". **If you do not intend to use the remote release button, disconnect the cord from the REMOTE socket to prevent accidental filming by pressing the remote button.**

This particular microphone is omnidirectional and may pick up the sound of the film drive and background noise when filming in quiet places. For best results, take it as close to the sound source as possible. If it is necessary to have someone else hold the microphone while filming, be sure to instruct that person not to knock the microphone, rub it or pull its cord



while filming or the soundtrack may be ruined by bothersome noise. The Dynamic Microphone DM 40 R has a built-in, anti-wind mechanism which takes the place of a wind screen.

A boom microphone can be slipped into the camera's accessory shoe for convenient recording when you find it necessary to move around a lot while filming. Canon offers two optional boom microphones.

Whether using a microphone or an auxiliary input, the sound should be monitored while filming. For this purpose, plug Earphone E into the MONI socket. Headphone HP-M, which is optionally available, can be used instead of Earphone E. **Monitoring is only possible if sound film is loaded and the shutter release lever is pressed at least halfway.**

* Near a high-tension wire or broadcasting tower, the microphone may pick up unpleasant noise. To recognize this type of electrical noise, monitoring should always be done with an earphone before shooting.



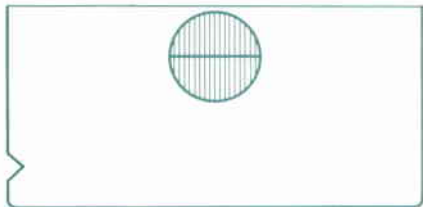

Recording Level Indicator

Recording Preview

If using sound film and recording, also check the volume when the shutter release lever is pressed halfway. It is best to have a sensory indication by using an earphone.

Also check the recording level indicator in the viewfinder. If this indicator is blinking on and off, the sound will be recorded perfectly. If the indicator glows steadily, there may be distortion. If possible, adjust the sound or the position of the microphone.

SPECIAL TECHNIQUES

*Lap dissolves are possible only with the 1014XL-S.

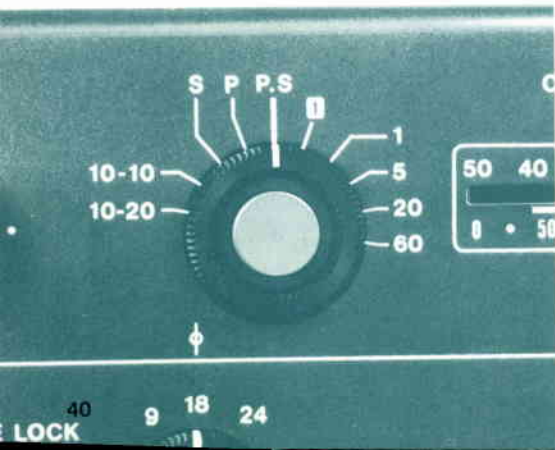

FILMING MODE DIAL

The filming mode dial is the key to most special techniques. Some techniques require the use of this dial with other controls. The chart on the next page, which shows the function of each setting on the filming mode dial, will provide easy reference while reading the following sections. The dial automatically locks at P.S position. To set it on another position, turn the dial while pressing the release button at its center until the dial click-stops at the desired setting.

The numerous positions on the dial are for various special uses:

- P: for normal filming; possibility of automatic lap dissolve of both picture and sound and automatic fade-in/out of picture only.
- S: for normal filming, possibility of automatic lap dissolve of both picture and sound and automatic fade-in/out of sound only.
- 10-10, 10-20: for self-timer filming.
- 1**: for single-frame filming.
- 1, 5, 20, 60: for timed interval filming.

Dial Setting	Function
P.S	Normal filming; automatic lap dissolve and fading of both picture and sound.
P	Normal filming; lap dissolve of both picture and sound; fading of picture only.
S	Normal filming; lap dissolve of both picture and sound; fading of sound only.
10-10	Self-timer filming with 10-second delay, 10 seconds of filming.
10-20	Self-timer filming with 10-second delay, 20 seconds of filming.
1	Single-frame shooting.
1	Timed interval filming at 1 frame/sec.
5	Timed interval filming at 1 frame/5 sec.
20	Timed interval filming at 1 frame/20 sec.
60	Timed interval filming at 1 frame/60 sec.

* Lap dissolves are possible only with the 1014XL-S.



SPECIAL EFFECTS WITH PICTURE AND SOUND

Fade-in/Fade-out of Picture and Sound



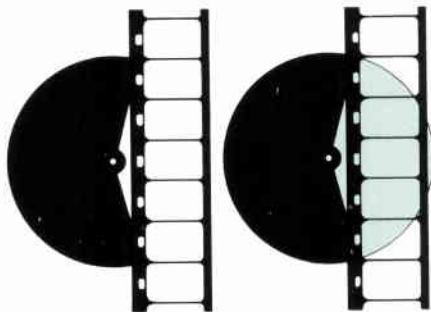

Fading is a filming technique that gradually dims the picture from normal exposure to total darkness (fade-out), or brings the picture up to normal exposure from total darkness (fade-in). The sounds accompanying the picture can also be faded in the same manner, and these sound and picture fades are especially useful for scene changes in your movies.

Fading is an easy process with the 1014XL-S and 814XL-S due to the unique design of the shutter opening angle mechanism and recording circuitry. The fade lever is normally in position at 0. The shutter blades slowly close when you move the lever to C, and re-open when you release the fade lever to its 0 position.







Fading can be used with the following combinations of dial settings and film types. Select the one that best suits your filming purpose.



USABLE DIAL SETTING COMBINATIONS

Dial	Sound Filming (Sound Cartridge)	Silent Filming (Silent Cartridge)
Filming Mode Dial	P.S, P, S	P.S, P
Shutter Opening Angle Dial	 	 
Filming Speed Dial	18, 24	9, 18, 24, SM

* If using a filming speed of 9 fps with a sound cartridge, fading of only the picture is possible. The sound circuit is automatically disconnected.

Filming Mode Dial Setting	Picture	Sound
P.S		
P		
S		

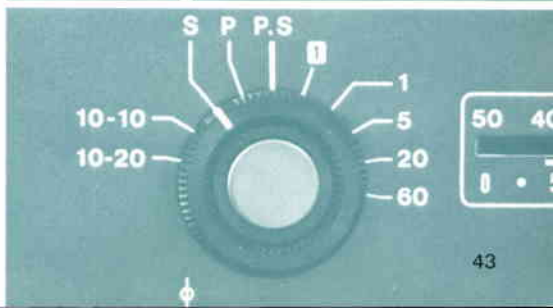



With the filming mode dial set at P.S, you can fade both picture and sound simultaneously. To finish a scene with a fade-out:

1. Rotate the fade lever to C while filming.
2. Keep the film drive engaged, and the camera will automatically shut itself off when the fade-out has been completed. This automatic stop mechanism is a safety device that prevents the unintentional filming of blacked-out frames. (If you do want to black out a few frames after fade-out, keep the fade lever at C, take your finger off the shutter release button, and then press it again.) **Be sure to hold the fade lever at C until the film drive automatically comes to a stop.** Otherwise, the shutter blades will re-open and the fade-out will not be completed.

To begin a scene with a fade-in:

1. Hold the fade lever in the C position for approximately five seconds while the shutter blades close.
2. Press the shutter release lever and then release the fade lever to its O position once you hear the sound of the film transport, indicating that filming has begun.

If you want to include a few black frames before the fade-in, hold the fade lever at C for some time after filming has started. **Be sure to hold the fade lever fully at the C position, or the shutter blades remain open and no fade-in footage will be filmed.** There is a fade-in safety device that prevents filming until the shutter blades are completely closed, if the lever is in the C position and the shutter release lever is pressed prematurely.

The time required for a complete fade is related to filming speed as follows.

FILMING SPEED	FADING TIME
9, 18 fps	Approximately 5 seconds
24 fps	Approximately 3.7 seconds
SM	Same as for 9/18 or 24 fps.

With the filming mode dial set at P, you can perform fades with the picture alone. The sound level is maintained as it was during the shooting, and the visual image fades in or out with the same operations as described with the P.S. setting.





With the filming mode dial set at S, you can perform fades with the sound alone. The visual image is maintained as it was during the shooting, and the sound fades in or out with the same operations as described with the P.S. setting. **At the S setting, the camera will not shut itself off automatically at the end of the fade-out. Monitoring during fading of sound at the P.S or S settings is, of course, possible with an earphone.**





For fade-in of sound when the filming mode dial is set at the S position, press the shutter release lever half-way first. In that position, monitor with an earphone to check that the sound is not being picked up. Then press the lever fully to start filming.

LAP DISSOLVES WITH PICTURE AND SOUND (1014XL-S ONLY)



Lap dissolving is a filming technique that merges and overlaps the end of one scene with the beginning of the next. For a few seconds, the film footage is shared by the visual images and sounds of both scenes, and these lap dissolves are especially useful when changing from one primary theme to another.

The lap dissolve can be used with the filming mode dial in the P.S, P, or S setting. At any of these settings, both sound and the visual image will be overlapped with sound film while only the visual image will be overlapped with silent film. With the 1014XL-S, lap dissolves can be used with the following combinations of dial settings and film types. Select the one that best suits your filming purpose.

USABLE DIAL SETTING COMBINATIONS

Dial	Sound Filming (Sound cartridge)	Silent Filming (Silent cartridge)
Filming Mode Dial	P.S, P, S	P.S, P, S
Shutter Opening Angle Dial	 	 
Filming Speed Dial	18, 24	18, 24

LAP DISSOLVE PROCEDURE

1. Set the filming mode dial at P.S, P, or S. (The lap dissolve function is inoperable at any other settings).
2. Set the shutter angle dial to  or  . Setting the dial to the window symbol  is suggested as then fading effect will be more obvious.

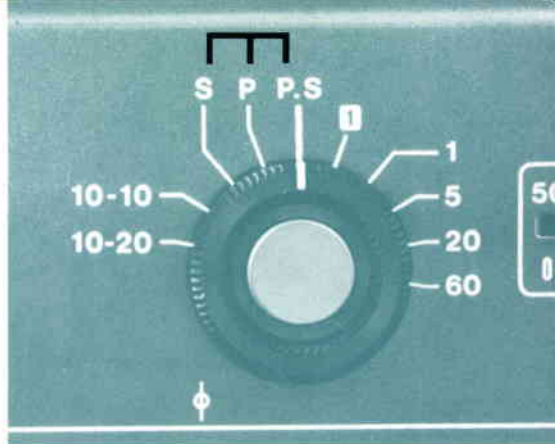



3. Press the shutter release lever to begin filming. **Use the same filming speed for fade-out and fade-in in lap dissolve shooting.**
4. Continue filming while you push the fade lever up to the lap dissolve symbol and push in the lap dissolve button in the center of the shutter angle dial. Once this button is pressed, the automatic lap dissolve function takes over, and you should remove your finger from the shutter release lever. When the dissolve portion has been completed, the film automatically rewinds and stops in position for the beginning of the next scene, which will be overlapped. **DO NOT** press the shutter release lever while the film is rewinding. You can confirm sound fading during dissolve operation and before the start of the overlapping scene by pressing the shutter release lever half-way.
5. Press the shutter release lever again to begin filming the next scene. The lap dissolve button will spring back to its original position when filming begins.

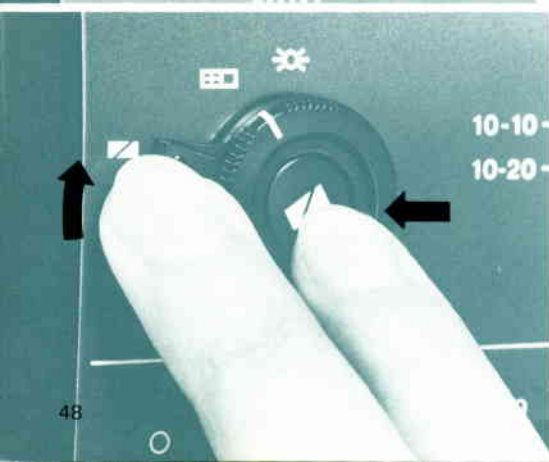

Note: In sub-freezing temperatures, lap dissolve with sound cartridge is sometimes not possible because the film tends to harden. Lap dissolve should not be

attempted with films having a hard base as the film perforations may tear.

The following functions are inoperable during the lap dissolve process:

1. Instant slow motion
2. Fade-in or fade-out using the fade lever.

RANGE OF APPLICATION FOR LAP DISSOLVE

Because of the room required for lap dissolve filming, do not attempt a lap dissolve in the first five or last 10 (**last 20 for Agfa film**) feet of film.

Note: If a partially used film cartridge is removed and later replaced in the camera, the counter will return to S and will not indicate the correct footage remaining. Up to three separate lap dissolves are possible for a roll of film.

LAP DISSOLVE CANCELLATION

If you should decide not to attempt a lap dissolve once you press the lap dissolve button, rotate the shutter angle dial to the (●) position to cancel the dissolve setting and continue with normal shooting. Do not attempt to cancel the lap dissolve once the fade-out begins or once the film begins to rewind, as the film has already been exposed with the fading image and would only be wasted if you attempted to stop and shoot.

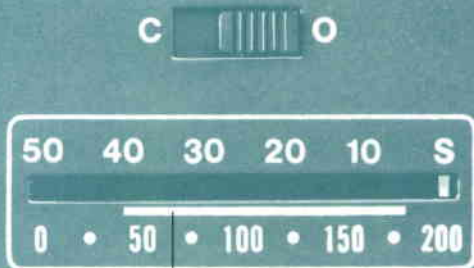

Linear indication where lap dissolve is possible

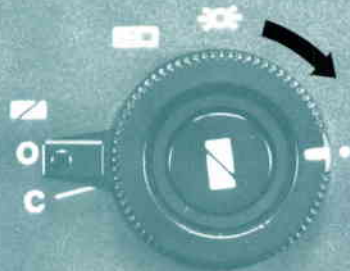

AUTO

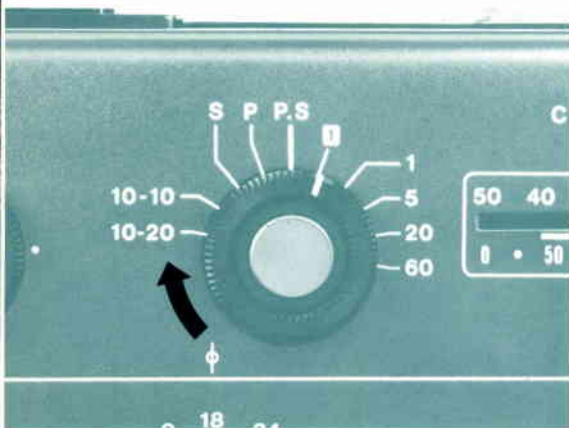

SPECIAL VISUAL EFFECTS

SINGLE-FRAME AND TIMED INTERVAL FILMING

Single-frame shooting is especially useful for filming animated sequences, or creating special movement effects. Timed interval filming enables you to record very slow movements in a speeded-up format that uses up less footage than would actual speed filming. With these special effects, the shutter speeds are those used for 18 fps filming — 1/40 sec. for a 150° shutter opening angle, and 1/30 sec. for 220°. Since timed interval filming causes heavy battery drain, the use of the Canon Power Pack 9V is recommended when using the interval timer setting. Power Pack 9V is an external power source which is optionally available.

The portion of the film which is exposed using the single-frame or interval timer mechanism will be silent even if a sound cartridge is loaded. The recording circuit is automatically disconnected. The table on the left shows possible combinations of dial settings and you should select the one that best suits your filming purpose.

USABLE DIAL SETTING COMBINATIONS

Dial	Single-Frame Filming	Interval-Timer Filming
Filming Mode Dial	1	1, 5, 20, 60
Shutter Opening Angle Dial		
Filming Speed	Any speed usable	

1. To film in the single frame mode, set the filming mode dial at the **1** position and push the shutter release button each time you want to expose a frame.
 2. For timed interval filming, set the filming mode dial at the 1, 5, 20, or 60 second interval position as needed. Shift the R/RL switch to RL and push the shutter release lever. A single frame is immediately exposed, and the camera begins the timed exposure of single frames at the pre-selected rate.
- * **The film end warning will not appear in the viewfinder if the film ends during single-frame or timed interval filming.**

The following functions are inoperable during single-frame and timed interval filming:

1. Lap dissolve (1014XL-S only)
2. Fade-in or fade-out using the fade lever
3. Instant slow motion
4. Filming speed control

DETERMINING TIMED INTERVAL

After deciding the projection time and filming speed, use the following formula to determine the filming mode dial interval setting prior to filming:

$$\text{Interval Time (seconds)} = \frac{\text{Filming Time (seconds)}}{\text{Projection Time (seconds)} \times \text{Filming Speed (frames/second)}}$$

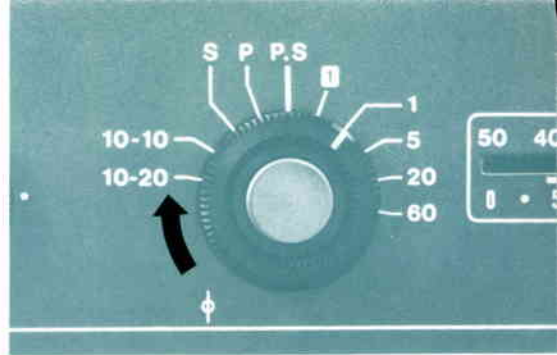

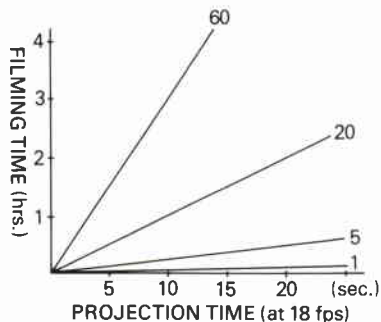



For example, if you want to show a flower blooming for 30 minutes in a 5 second period, the standard filming speed (18 fps) times the projection time (5 seconds) produces 90 frames as the finished footage. When the blooming time of 30 minutes (1800 seconds) is divided by 90 (frames), 20 seconds is determined as the timed interval setting. Set the filming mode dial at the 20 position. The finished film will then show a thirty minute process in just five seconds.

SELF-TIMER FILMING

The self-timer is useful when you want to include yourself in the scene you are shooting, or when filming has to be done with the operator away from the camera. Both sound and silent self-timer filming are possible, and you have a choice of ten or twenty second shooting times.

Setting of Dials for Self-Timer Filming

Dial	Sound Filming (Sound Cartridge)	Silent Filming (Silent Cartridge)
Filming Mode Dial	10-10, 10-20	10-10, 10-20
Shutter Opening Angle Dial		
Filming Speed Dial	18, 24	9, 18, 24

When shooting at 9 fps, only silent filming is possible, even when a sound cartridge is used. Manipulating the fading lever will have no effect.

Waiting and Filming Time with Self-Timer

Filming Mode Dial	Waiting Time	Shooting Time
10-10	10 seconds	10 seconds
10-20	10 seconds	20 seconds

To use the self timer function:

1. Turn the filming mode dial to the 10-10 or 10-20 position as desired.
2. Set the proper shutter opening angle and filming speed, and shift the running lock switch to the RL position.
3. Compose the shot and close the eyepiece shutter (light entering the viewfinder could affect exposure during filming).
4. Press the shutter release lever to begin the 10-second wait and automatic shooting.

The cue light will flash at the rate of 1 time per second during the waiting interval and 8 times per second during filming. Since the AE circuitry is disconnected and viewfinder exposure

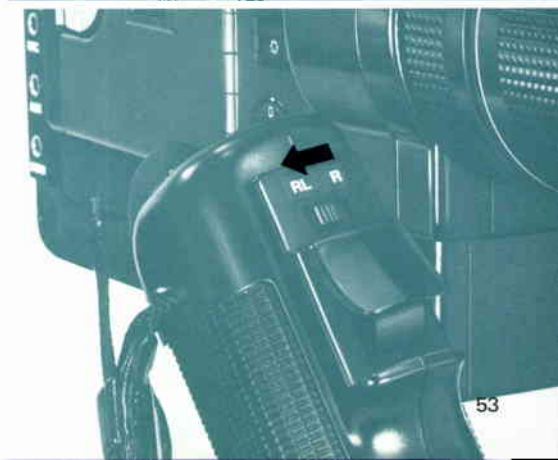
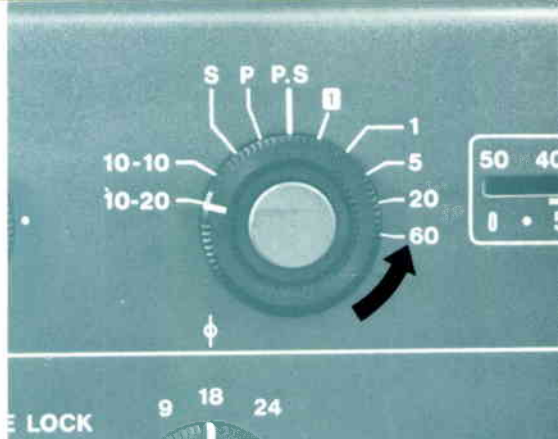



information is turned off during the 10-second pause before filming begins, check the exposure before pressing the shutter release lever all the way in to activate the self-timer. The camera automatically controls the exposure during actual filming.



SLOW MOTION SHOOTING

Slow motion shooting is useful for capturing the details of actions or movements which are otherwise too fast to be discerned. Slow motion footage can also add a dramatic touch to filmed action sequences.

These cameras allow you to switch to slow motion from any filming speed setting (9, 18, or 24 fps.) by simply pressing the SM button in the center of the filming speed dial. With a fresh set of batteries, the SM button will take the filming speed up to 36 fps. The button is spring-loaded and will cancel itself immediately when you remove your finger pressure.

Slow motion filming is possible only with silent film. The SM button is inoperative with a sound film cartridge. The following chart describes the dial settings with which the SM button will operate.

Setting of Dials for Slow-Motion Shooting

Dial	Silent Cartridge
Filming Mode Dial	P, S, P, S
Shutter Opening Angle Dial	 
Filming Speed Dial	9, 18, 24

1. To turn normal filming to slow motion shooting, simply push the SM button at the instant you wish to begin the slow motion sequence.
2. If you want to film in slow motion from the beginning of a scene, push the SM button and then hold it in place as you push the shutter release lever.



FILMING TECHNIQUE CHART

	Mode Dial	Filming								Cue Light	Viewfinder Exposure Indication	Remarks
		Sound Cartridge				Silent Cartridge						
		9	18	24	SM	9	18	24	SM			
Normal Filming	P.S, P, S	○	⊙	⊙	×	○	○	○	○	Flashes 8 times/sec. during filming	Lights up at first pressure of shutter release	
Fading, in/out	P.S	○	⊙	⊙	×	○	○	○	○			Picture and sound, automatic stop
	P	○	⊙	⊙	×	○	○	○	○			Picture only, automatic stop
	S	○	⊙	⊙	×	○	○	○	○			Sound fade only
Lap Dissolve	P.S, P, S	×	⊙	⊙	×	×	○	○	△	Out during auto reverse (Out when finger removed from shutter lever)	Image/sound synchronization	
Single Frame	[1]	○	○	○	×	○	○	○	×	On during exposure	On at first pressure of shutter release	
Interval	1, 5, 20, 60	○	○	○	×	○	○	○	×	On during exposure Out during interval	On right before exposure Out during interval	R/RL switch on RL
Self-Timer	10-10 10-20	○	⊙	⊙	×	○	○	○	○	Flashes once/sec. during delay, 8 times/sec. during filming	Out during waiting time On during filming	R/RL switch on RL

⊙ Both sound/silent filming possible.

○ Only silent filming possible.

× Slow motion button does not function.

△ Slow motion possible after fade-in filming.

× Neither silent nor sound filming is possible.

MACRO FILMING

The 1014XL-S and 814XL-S lenses incorporate both a wide angle macro and telephoto macro mechanism, useful for filming titles or small subjects such as insects or plants. Wide angle macro provides close-up filming by switching over to macro at the end of the wide angle zoom. Telephoto macro provides close-up filming by switching to macro with the focusing ring, at the telephoto end of the zoom range. Each macro mechanism produces different results.

Filming Distance and Field of View

Macro System	1014XL-S		814XL-S	
	Filming Distance (cm)	Field of View (cm)	Filming Distance (cm)	Field of View (cm)
Wide-Angle Macro	25.0	8.7 × 12.0	24.0	8.2 × 11.5
Telephoto Macro	72.0	3.3 × 4.6	66.0	3.6 × 5.0

- * It is advisable to use a remote control switch and a copy stand or tripod when doing macro filming, as blurring caused by even slight camera movement is always a danger.
- * Filming distances in this chart are measured from the film plane indicator to the subject.





FILMING PROCEDURE WIDE-ANGLE MACRO

1. Rotate the zooming ring to the shortest focal length.
2. Push the macro set button and rotate the zooming ring into the MACRO range indicated by a yellow line.
3. To film from a fixed distance, continue to rotate the zooming ring until it locks into position at the end of the yellow line. Focus by moving the camera back and forth while looking through the viewfinder until the subject is sharp.
4. You can also focus on your subject by unpushing the macro button and rotating the zooming ring within the distance of the yellow line below the word MACRO (to the right of the shortest focal length indication). Confirm proper focusing in the viewfinder.

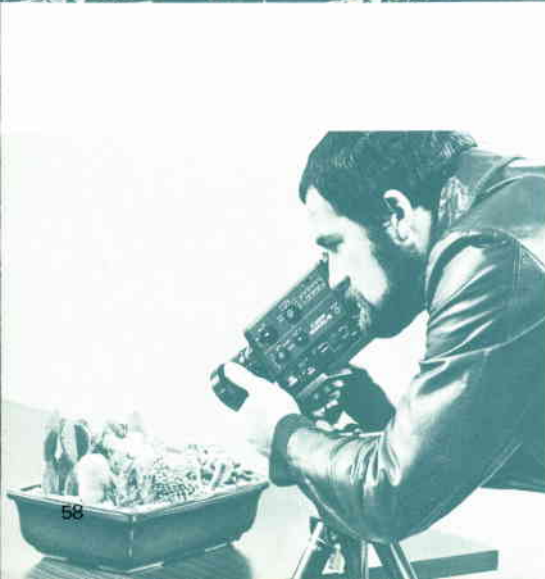

TELEPHOTO MACRO

1. Rotate the zooming ring to the longest focal length.
2. Next, rotate the focusing ring beyond the closest focusing distance, into the yellow line area (to the left of the focusing ring 4 ft./1.2 m designation).
3. Use the focusing ring to focus **in the yellow area** just as you would in regular filming.

If the zooming ring is not fully in the telephoto zone during telephoto macro filming, you may experience some image cut-off in the viewfinder.

Depth of Field

Depth of field is the range in front of and behind the subject which is in focus at the same time as the subject.

Since the depth of field can become extremely shallow in macro filming, film under the brightest light conditions possible, and be especially careful when focusing. Illuminate the subject so that for the telephoto macro an aperture smaller than $f/5.6$, for instance $f/8$, can be used and for the wide angle macro, an aperture smaller than $f/2.8$, for instance $f/4$.

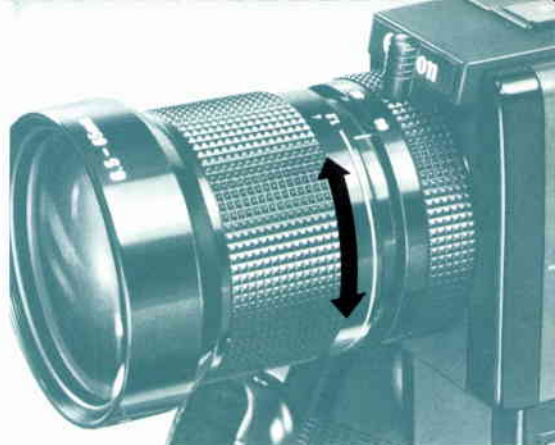

Depth-of-Field for the Nearest Focusing Distance

Aperture	1014XL-S		814XL-S	
	Wide-Angle Macro (nearest focusing distance) (cm)	Telephoto Macro (nearest focusing distance) (cm)	Wide Angle Macro (nearest focusing distance) (cm)	Telephoto Macro (nearest focusing distance) (cm)
f/1.4	24.2–26.0	71.9–72.1	23.3–24.8	66.8–67.2
f/2.8	23.5–27.1	71.7–72.3	22.6–25.7	66.7–67.3
f/5.6	22.2–29.8	71.5–72.5	21.5–27.8	66.4–67.7
f/16	19.1–58.7	70.5–73.5	18.7–45.2	65.2–68.9
f/45	15.5–∞	67.8–76.4	15.0–∞	62.0–72.4

Characteristics of Wide-Angle and Telephoto Macro

- The filming distance and field of view differ as shown by the table on page 57. Telephoto macro is advantageous when filming under artificial lighting or when your subject tends to move away from the field of view.
- Wide-angle macro emphasizes the subject's perspective, whereas telephoto macro tends to flatten or reduce this perspective.

READJUSTING EXPOSURE

Use the AE dial and exposure compensation dial to permit perfect exposure every time, even when filming under unusual lighting conditions. These dials also give you the creative freedom to take advantage of varying light qualities that will add interest to your movies.

EXPOSURE COMPENSATION DIAL

The exposure compensation dial allows you to handle unusual lighting situations while filming in the AE mode. Adjusted exposure is possible at approximately one-third f-stops, to a total of one f-stop over or below the aperture value displayed in the viewfinder.

To find the proper amount of exposure compensation, compose your shot and check the f-stop by depressing the shutter release button half-way. Next, move close enough to fill the viewfinder with the subject, and check the f-stop again. The amount of compensation necessary is the difference in value between the two f-stops. In cases where more than one f/stop compensation is required, use manual exposure as explained on pages 63—64.

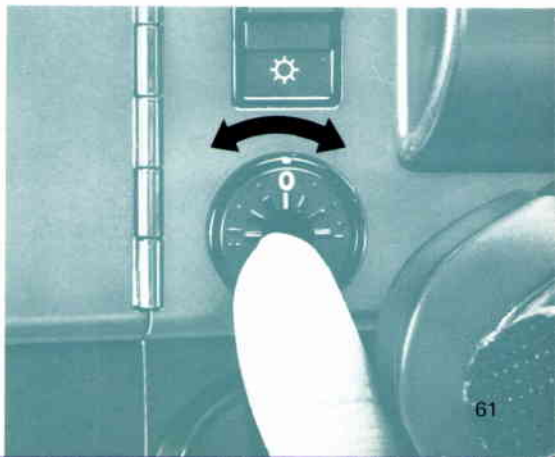

When filming a subject backed by bright light (a window or mid-day sky in the background) you need to increase the exposure to bring out details in the subject. Push the exposure compensation dial with your finder tip and rotate it clockwise to increase the exposure provided by AE filming. The dial will click into position at one-third, two-thirds, and one complete f-stop larger than that selected by the automatic exposure system.

On the other hand, when filming a bright subject surrounded by darkness or dim lighting, you need to decrease the exposure to prevent over-exposing the subject. Push the exposure compensation dial with your fingertip and rotate it counterclockwise to decrease the exposure provided by AE filming. The dial will click into position at one-third, two-thirds, and one complete f-stop smaller than that selected by the automatic exposure system.

Whether increasing or decreasing exposure, the exposure compensation dial will remain in its set position until returned to the neutral O position; therefore, do not forget to reset the dial upon completion of filming.

AE LOCK

The AE LOCK position of the AE dial is used to set and hold a specific exposure, as might be desirable when panning a moving subject. Point the camera at the subject, compose your shot and check the aperture indication in the viewfinder. Push the release button in the center of the exposure control dial, and rotate the dial clockwise to position at AE LOCK. The manual aperture warning lamp will light up in the viewfinder to remind you that the camera is not in the AE mode. The f/stop locked in at the time the AE dial was moved to the AE LOCK position remains unchanged during the shooting unless the AE dial is moved to another position.

MANUAL EXPOSURE

The MANUAL position of the exposure control dial allows you to set the f-stop manually with the aperture control lever. This function is especially useful when filming scenes in which the subject is backed by extremely bright light, or when exposure compensation of more than one f-stop is necessary.



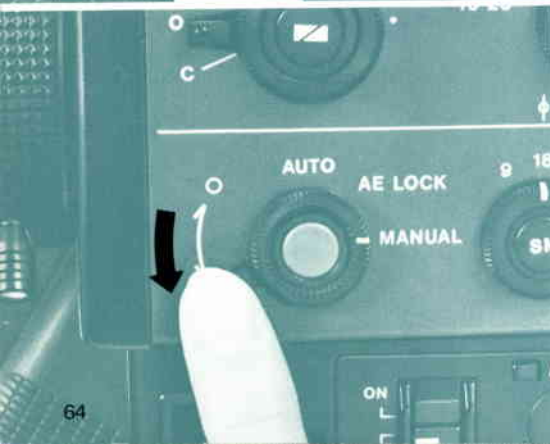

1. Point the camera at the subject, and move close enough to fill the viewfinder with the subject.
2. Push the release button in the center of the exposure control dial, and rotate the dial clockwise to position at MANUAL. The manual aperture warning lamp will light up in the viewfinder to remind you that the camera is not in the AE mode.
3. The aperture control lever, inoperative in all modes but MANUAL, can then be moved up to **O** to open the iris diaphragm or down to **●** to close the diaphragm, giving you the aperture value that you need **while pressing the shutter release lever halfway**.
4. Check the aperture indication in the viewfinder, and release the aperture control lever when the viewfinder shows the desired f-stop. The exposure value is retained by the camera when you begin filming, and will be held until the exposure control dial is moved to the AUTO position or until you push the aperture control lever again.

REMOTE CONTROL

A remote control switch can be used for filming when you yourself want to be at a distance from the camera, such as when filming wild animals. The remote control switch is plugged into the REMOTE jack and controls the filming action of the camera in the same manner as does the shutter release lever. The camera's R/RL switch is to be set to the R (running) position. When used with the remote control switch, the viewfinder exposure indicator will not work; however, the exposure can be checked by pushing the shutter release lever half-way, as the shutter release lever still operates normally even with the remote control switch plugged in. If the film jams while filming by remote control, the film jam warning will appear only momentarily in the viewfinder.

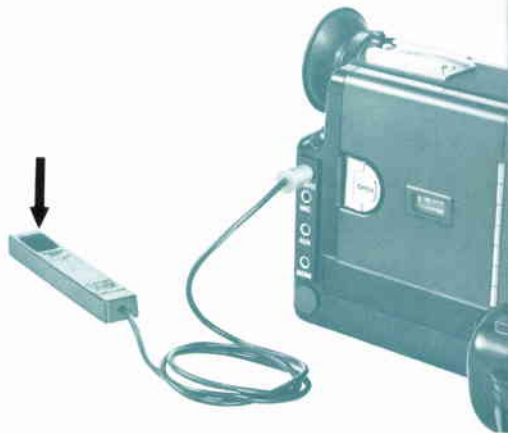



EXTERNAL POWER SOCKET

This socket which is located on the grip, permits attachment of a special external power source, the Canon Power Pack 9V. This accessory is optionally available for providing more suitable power when you intend to do a great deal of continuous filming or when filming in low temperatures. Power Pack 9V can be kept inside a pocket to keep the batteries warm during filming.

* The plug of the external power source used must have a negative center pin. Do not use external power accessories other than those of the Canon make. The use of accessories with different pole arrangement could cause damage to the camera's circuitry.

Note on Accessory Shoe

The accessory shoe of the camera is designed for direct attachment of a boom microphone and wireless receiver. If you wish to use a movie light, it should be attached by means of the Canon Lighting Adaptor LA-1 which is optionally available.



USING FLASH

The 814XL-S and 1014XL-S are provided with a flash sync socket on the left panel. The use of flash is very handy for photographing titles or animation in the single-frame mode. The shutter opening angle dial may be set to either of its two positions, and the aperture must be adjusted manually (see page 64) to an f/stop which is determined by dividing the guide number of the flash by the focused distance (read from the lens' distance scale). Follow the instructions of the flash used. Generally, the life of a flash tube is about 5000 flashes or enough to give continuous flash exposure to every frame of about 1-1/2 film cartridges.

Perfect and uniform exposure is essential in 8mm flash shooting. Since, during projection, the picture frames are shown in sequential motion, uneven exposure will cause flickering on the screen. Pay special attention to the exposure. If possible, either use a flash with a voltage-stabilizing circuit or use an AC (house current) power source, and shoot immediately after the pilot lamp lights up.



SPECIAL EFFECTS WITH SOUND

MANUAL SOUND RECORDING

Manual sound recording is used when you want to make the input level of the sound track more even. If the level of sound is fairly low, but occasional loud sounds come rushing in, the input level would change too radically to be handled by the ALC, rendering natural recording impossible. Manual sound recording can also be used to purposely distort sounds to create special effects.

In the manual recording mode, the sound volume is regulated by the volume control knob, turned clockwise to increase the recorded sound level, and can be monitored by looking at the volume level scale of the level meter. The meter needle usually rests in the left half of the scale, and slides to the right as the sound level increases. If the needle should enter the red during your manual sound recording, the sound will be distorted.

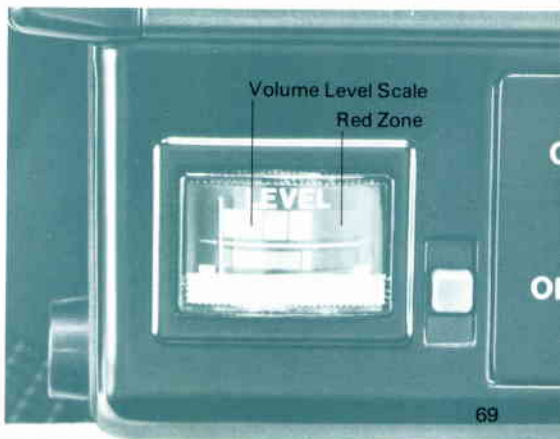



LIMITER

The limiter position of the recording mode dial gives you manual control of sound volume recording, while also giving you the protection of the ALC. First determine the volume using the volume control knob at the **MANUAL** position of the recording mode dial. Then turn the dial to **LIMITER** where the limited-function ALC will automatically subdue any extremely loud sound input that could suddenly send the meter needle into the red.



MANUAL

The manual position of the recording mode dial gives you total control of sound volume recording by using the volume control knob, without any interference or protection from the ALC. The manual position is often used for emphasizing or playing down the strength of sound. Since monitoring sound input is difficult in this mode, the manual setting is suggested for use only by experienced persons or when an intentionally distorted sound track is desired. Use of the -20dB position of the microphone attenuator switch at the **MANUAL** setting of the recording mode dial may be effective in certain recording situations. See page 72.

NORMAL

Usually the switch should be set to this position. At this position, the camera will record surrounding sounds of your interest as they are, making use of the camera's entire recording frequency range. It is also suitable for recording bass sounds such as those from music, drums, bells, etc. Since it limits echo, all sorts of sounds will be recorded providing there is no background noise, such as wind.

BASS CUT

At this setting, the low range of the recording frequency is eliminated to record sounds clearly when the sound source is close to the microphone, when filming inside an echoing room or in windy, noisy places, or during street interviews.

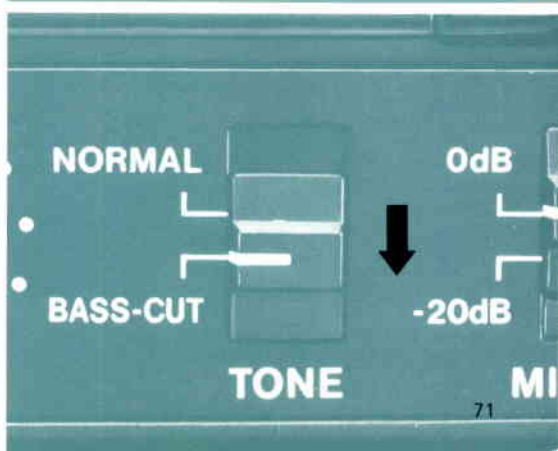

MICROPHONE ATTENUATOR SWITCH

This switch is used to change the microphone input level. **In most cases it should be set to 0dB, a position in which it locks.** It should be set to -20dB in the following situations:

1. When recording outdoors or in noisy areas.
2. When recording a sound, such as that of a jet engine which is so loud that it is impossible to reduce the input level by adjusting the volume control dial alone.

To set the switch at this position, push it down while pressing the microphone attenuator lock button. To return it to the 0 dB position, simply push it back up. This switch is usable at any recording mode dial or tone control switch position but is most effective when used in connection with the volume control dial with recording mode dial at the MANUAL position. It has no effect on recording done from an auxiliary input.

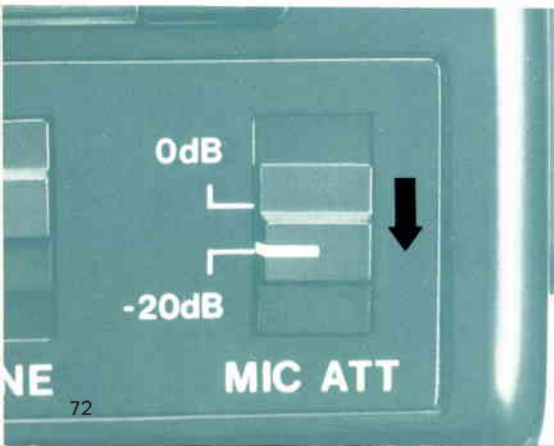
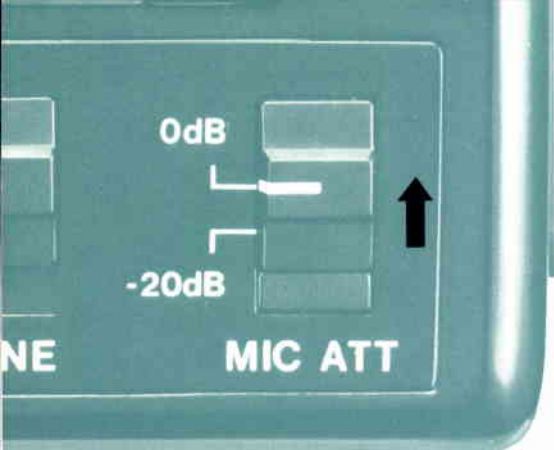

AUXILIARY INPUT AND MIXING

To record sound from audio equipment such as a tape recorder, television, or radio while filming, use the AUX input jack instead of a microphone which might pick up unwanted noises from the surrounding area.

1. Set all recording dials at their normal positions when recording directly from audio equipment.
2. Connect the camera to the sound source with the Connecting Cord C300L optional accessory.
3. After turning on the sound source, monitor the sound through the camera by pushing the shutter release button half-way. Adjust the volume of the sound source as appropriate, and monitor the sound quality in the earphone and volume level meter once again.
4. If you wish to record conversation or natural sounds along with the audio input, use the microphone in its MIC jack along with the auxiliary source connected to the AUX jack to mix the sounds.



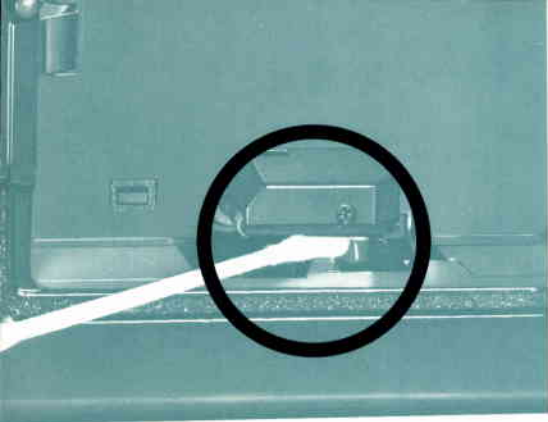

CLEANING OF RECORDING HEAD

Since film passes through the head pinch roller and capstan, these parts can become dirty and affect image or sound quality. Use the included cotton swab with only a little alcohol to clean the recording head after every five cartridges.

PULSE SYNCHRONIZED RECORDING

When recording on a separate tape recorder while filming, it is also necessary to record a pulse signal simultaneously so that the sound can be synchronized with the film during projection. For this purpose, a stereo tape recorder and an accessory sync-controller/pulse generator are required. The tape recorder must have a manual volume control and be capable of playback from each speaker separately, i.e. have separate volume control (for each speaker). The pulse generator is connected between the camera and the recorder.

1. Connect the 8-pin plug of the pulse generator to the synchronization socket of the camera. Branch a connecting cord between the pulse generator and the R-terminal of the tape recorder. Connect the microphone to the recorder's L-terminal.



2. Prepare the camera for filming and set it for 18 fps. Transport the film for approximately five seconds to allow room for cutting the film during development and for editing.
3. Prepare the tape recorder by setting the R-recording volume to the maximum level and the L-signal volume to the level you want.
4. After transporting the tape for several seconds to take up the tape leader, press the camera's shutter release lever to start filming. A synchronized pulse signal will be recorded on the R-side of the tape while the sound through the microphone will be recorded on the left side. The camera sends a pulse signal for each frame. Depending on the type of accessory sync-controller used, this may be converted to a signal for every four frames.
5. When the film end warning indication in the viewfinder starts to blink, stop filming and stop the recorder. (The camera has no control over starting and stopping the recorder.) Then cap the lens and finish running the film to the end.
If you continue to shoot until the film reaches a complete end, extra synchronization signals will be recorded which will make editing more difficult.

- * When playing back a quiet soundtrack, some tape recorders may play back the pulse noise as well.

Editing and Splicing

For post-recording and film editing, follow the instructions of the individual pieces of equipment used. Tape should be used for splicing. The use of cement would require cutting every frame that is not spliced properly and would prevent proper synchronization of the recording to the film. When splicing, cut the film at right angles to the direction of transport.

The 8-Pin Jack

The internal connections of this jack are as illustrated on this page. Connections 1-4 are used for the sync-controller. When making separate connections, be careful not to connect 3 to 4 which might cause a short circuit or other internal circuit problems.

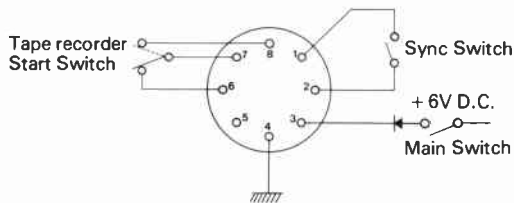

Caution: Do not short pins 3 and 4

ACCESSORIES



Filters



Step-up Ring 62-67

Note: Since the 1014XL-S and 814XL-S are highly advanced, electronically-controlled cameras, certain electronically-controlled accessories, Self-Timer E and Interval Timer E, are unsuitable for use.

FILTERS

Since these cameras use through-the-lens light metering systems, exposure compensation is not necessary even when using a filter. To use a filter with the 1014XL-S, first attach the Rubber Hood SC-67 and then screw a 72 mm filter into the hood. A 62 mm filter can be attached directly to the 814XL-S. Do not use one filter over another filter.

SPECIAL LENS ATTACHMENTS

The three supplementary lenses described on the following pages screw directly into the 67 mm filter threads of the 1014XL-S's lens. **For attachment to the lens of the 814XL-S, it is necessary to screw Step-up Ring 62-67 between the lens filter threads and the accessory.**

C-8 Wide Attachment Lens 67

With the zooming ring set for wide-angle macro filming and the focusing ring at infinity, attachment of this accessory shortens the focal length of the 1014XL-S's lens to 4.3 mm and of the 814XL-S's lens to 4.5 mm. When using this accessory, the necessary aperture should be f/2.8 or smaller, such as f/4. If necessary, lighting should be adjusted to enter this aperture range.

Tele-Converter 1.4X 67

With the zooming ring set in the telephoto range, this accessory extends the focal length of the 1014XL-S's lens to 91 mm and of the 814XL-S's lens to 78.4 mm for super-telephoto filming. Since depth of field becomes very shallow, the aperture should be f/4 or smaller, such as f/5.6. Adjust the lighting if necessary. The tele-converter is effective when the zooming ring is set to any focal length of 30 mm or longer.



C-8 Wide Attachment Lens 67



C-8 Tele Converter 1.4 × 67



67mm Close-up Lens 240 C-8

67mm Close-up Lens 240 C-8

Attaching this accessory permits higher magnifications than are possible with the lens' built-in macro mechanisms. It derives its name from the fact that the shooting distance from the tip of the lens to the subject is 240 mm when the focusing ring is at infinity for the minimum magnification. The shooting distance becomes shorter and the magnification higher as the focusing ring is rotated to closer distances. Since depth of field is critical, the aperture should be kept to $f/4$ or smaller, such as $f/5.6$.

SMALLEST FIELD-OF-VIEW WITH CLOSE-UP LENS 240C-8

Camera	Zooming Ring Position	Focusing Distance	Film Plane to Subject Distance	Field-of-View
1014XL-S	6.5 mm	∞	40.0 cm	15.0 × 20.7 cm
		1.2 m	36.9 cm	12.4 × 17.1 cm
	65 mm	∞	40.0 cm	1.6 × 2.2 cm
		1.2 m	36.9 cm	1.3 × 1.8 cm
814XL-S	7 mm	∞	39.3 cm	13.9 × 19.2 cm
		1.2 m	36.0 cm	11.6 × 16.0 cm
	56 mm	∞	39.3 cm	1.9 × 2.6 cm
		1.2 m	36.0 cm	1.5 × 2.1 cm

MICROPHONES

WM-50 Quartz Wireless Microphone and WR-50 Quartz Receiver

The wireless microphone and receiver permit remote control filming without the annoying interference of cords. This accessory group is especially useful when filming in unusually noisy locations.

Wireless
Microphone
WM-50 Quartz
and Wireless
Receiver WR-50 Quartz
*FCC approval pending



Electret Condenser Microphone CM 100

This is an excellent, high-performance, unidirectional microphone, designed to pick up sound in the direction it is pointed while minimizing sound pick-up from the sides and back.



Electret Condenser Microphone CM 100

Boom Microphones BM-50 and BM-70

The boom microphones are attached to the accessory shoe of the 1014XL-S or 814XL-S, and are especially convenient for use during hand-held filming sessions where you must move or change your position often.



Boom Microphones
BM 70 and 50



CHEST POD II

This convenient accessory screws into the tripod socket and provides an additional measure of stability to hand-held filming. The Chest Pod II is adjustable to fit different body builds. Its arm can be swung down 135° where it locks. The length of the arm can be adjusted by turning the tightening ring counterclockwise and extending or retracting the arm. When the tightening ring is released, it automatically locks into place.

MICROPHONE EXTENSION CORD E450Y

This cord is specifically designed for use with the 1014XL-S and 814XL-S to extend the distance between the camera and the microphone or remote control device when the subject is relatively far away from the camera. First, connect the Extension Cord E450Y to the microphone or to the remote control device, and then make connection to the camera.

* When using the Extension Cord E1000, an accessory to extend the distance between the remote control device and the camera, connect the E1000 to the remote control device first and then to the camera.



Microphone Extension Cord E450Y

* The Extension Cord E450L is not for use with the 1014XL-S/814XL-S cameras.

CARE OF THE CAMERA

No matter how well-built your camera may be, it cannot function optimally unless it is taken care of properly. Please observe the following cautions to keep your camera in the best possible operating condition.

Cleaning

Do not touch the lens with your fingers. Remove any dust or lint on the lens surface with a blower brush, and then moisten a piece of camera lens cleaning paper with a couple of drops of camera lens cleaner fluid and use it to lightly wipe the surface with circular motions.

Dust can also accumulate in the film gate, reducing the effectiveness of your camera and possibly damaging the film. Clean the film gate occasionally with a blower brush.

After using your camera at the beach, be sure to clean it thoroughly. Sand and salt can cause irreparable damage if allowed

to accumulate in the lens or body. If you should accidentally drop your camera in the water, it may be beyond repair, but take it immediately to an authorized Canon service facility to check on the extent of the damage.

Storage

If you must store your camera for extended periods of time, first remove the batteries to prevent possible corrosion to the terminals. Cap the lens and store the camera in a cool, dry, dust-free place. Avoid storing it in the glove compartment, rear window shelf, or other hot areas of an automobile, or in harmful environments such as a laboratory where chemicals could cause corrosion and rust. When not in use, keep the lens capped to prevent the accumulation of dust and to eliminate the possibility of extraneous light entering the camera and damaging the film, and keep the power switch in the OFF position to prevent accidental battery drain.

Caution

Recorded films are sensitive to the effects of magnetism. Therefore, do not place film cartridges on or near magnets, motors, speakers, transformers, or radios. **Do not touch the recording head with anything metallic.**

Direct Sunlight

If the camera is left unattended with its lens exposed to direct sunlight, the film may get spoiled. Make it a habit to keep the cap on whenever the camera is not in use.

Using the Camera in Very Low Temperatures

When filming in very low temperatures, always protect the camera from outside air and try to finish shooting as quickly as possible. Use fully-charged Ni-Cd batteries when filming in sub-freezing (0°C, 32°F) temperatures, and keep the batteries warm in a pocket until you are ready to film. Although a battery may not function well in low temperatures, do not throw it

away, as it may work perfectly again when you use the camera in warmer temperatures. Avoid extreme temperature changes. Condensation forming on a camera and lens taken from cold temperatures into a warm room may cause corrosion. Let the camera gradually adjust to the temperature change by placing it in a completely sealed plastic bag for a while.

Specifications

Type: Super 8 SLR (single-lens-reflex) XL camera for sound and silent filming. Magnetic stripe recording (single system) with Super 8 cartridge as well as double sound system (pulse-sync) recording, latter for joint use with a stereo tape recorder.

Frame Size: 5.8 × 4.2 mm

Lens:

814XL-S: 7—56 mm f/1.4 with 8:1 zoom ratio; 16 elements in 13 groups; built-in wide-angle and telephoto macro mechanisms; Spectra Coating; ø62 mm filter and cap size: screw-in, detachable rubber hood.

1014XL-S: 6.5—65 mm f/1.4 with 10:1 zoom ratio; 17 elements in 13 groups; built-in wide-angle and telephoto macro mechanisms; Spectra Coating; ø72 mm filter threads (filter attached over hood); ø67 mm cap; screw-in, detachable rubber hood.

Focusing: By rotation of focusing ring.

Distance Scale:

ft	4	5	7	10	15	50	∞
m	1.2	1.5	2	3	5	10	

Zooming Mechanism: Manual and power zooming possible. Power zooming by independent motor. Two power zooming speeds; "L" covers entire zooming range in 9 sec. "H" covers entire zooming range in 5 sec. Zooming lever extendable for manual operation.

Zooming Scale:

814XL-S:	56	40	30	20	15	10	7
1014XL-S:	65	40	30	20	15	10	6.5

Macro Mechanism:

Wide-angle: By macro set button. Minimum focusing distance and field of view: 10 cm, 8.2 × 11.5 cm for **814XL-S**; 10 cm, 8.7 × 12.0 cm for **1014XL-S**.

Telephoto: By focusing in yellow focusing range. Minimum focusing distance and field of view: 53 cm, 3.6 × 5.0 cm for **814XL-S**; 56 cm, 3.3 × 4.6 cm for **1014XL-S**.

Viewfinder: Single-lens reflex type with split-image rangefinder.

Viewfinder Information: The following indications function at first pressure of shutter release lever: Illuminated aper-

ture indication with over and under exposure warnings, manual aperture control indication, LED recording level indication, footage indicator needle.

LED warning signal in **814XL-S** and END warning signal in **1014XL-S** blink 2ft before end of film and glow steadily to indicate film end, film jam, battery exhaustion.

Eyepiece Adjustment: -5 to +3 diopters by rotation of eyepiece ring. With lock.

Eyepiece Shutter: Built-in.



Eyecup: Built-in, foldable.

Shutter Release Lever: Two-step, electromagnetic release. Pressing halfway activates viewfinder information, readies camera. Pressing completely starts film drive.

Filming Speed: Sound cartridge: 1 and 9 fps (silent filming), 18 and 24 fps (sound filming). Silent cartridge: 1, 9, 18, 24 fps and instant slow motion (approx. 36 fps).

Shutter Opening Control: By independent DC micro-motor.

Shutter Opening Angle: Variable. By

rotating dial with click-stop settings. Two settings:  (220°) for XL filming,  (150°) for regular filming. Automatic exposure compensation at either setting. Angle varies continuously from 220° or 150° to 0° for fading at electronically-controlled speed.

Fading: By variable shutter opening angle. Automatic fade-in/fade-out possible for picture and sound simultaneously (at P.S position of filming mode dial), picture only (P position of mode dial), sound only (S position of mode dial).

Lap Dissolves:



1014XL-S only: Automatic. Possible at P.S, P or S setting of filming mode dial. At any of three above settings, picture and sound dissolve simultaneously with sound cartridge, picture only with silent cartridge. At the end of the first scene, film rewinds automatically about 90 frames to ready the camera for the overlapping scene.

Running Lock: Possible at "RL" position of R/RL switch on grip.

Flash Synchronization: Built-in socket for flash sync.

Self-Timer: Built-in. Two settings, for 10 seconds delay-10 seconds filming and 10 seconds delay-20 seconds filming.

EE Mechanism: TTL type Servo EE mechanism (using servo motor) with SPC (silicon photocell) controlling five-bladed iris diaphragm, coupled to film speed and filming speed. With AE lock.

Light Metering Range: For tungsten type film, from ASA 400, f/1.4,  (220°), 9 fps (CCA filter removed) to ASA 25, f/45  (150°), approx. 36 fps (CCA filter in place).

Film Speed: Automatically set by inserting film cartridge:

Tungsten Type Film: ASA 25 to 400

Daylight Type Film: ASA 16 to 250

Exposure Compensation: Seven click stop settings for -1, -0.6, -0.3, 0, +0.3, +0.6, and +1 f/stop.

Color Temperature Adjustment Filter: Built-in for use of artificial light type film in daylight; cancelled automatically with insertion of daylight type film cartridge; Manual cancellation

possible.

Manual Exposure Control: Full manual override possible.

Main Switch: On-off two-position switch.

Remote Control: ϕ 2.5 mm REMOTE jack for remote control accessories.

Footage Counter: Shows exposed footage (any filming speed) and remaining filming time (at 18 fps).

1014XL-S only: Linear indication shows where dissolve operation is possible.

Battery Life: Under normal temperature, more than 7 sound cartridges or more than 10 silent cartridges at 18 fps. About one cartridge for single-frame shooting at one fps.

Battery Checker: Combined recording level/power level meter needle. Built-in battery check button.

Microphone Jack: ϕ 3.5 mm mini-jack. Input impedance of around 5k Ω . Minimum input sensitivity, -20dBv (0dB = 1V).

Aux Jack: ϕ 3.5 mm mini-jack. Input impedance, 50k Ω .

Sound Input Monitor: Monitoring with recording level indicator (LED signal), level meter, and with an earphone or headphone.

Monitor Jack: ϕ 3.5 mm mini-jack suitable for 8Ω earphone.

Recording Level: ALC (Automatic Level Control), LIMITER and MANUAL. Automatic sound fading possible at all three positions. ALC position for automatic recording at correct volume. LIMITER and MANUAL positions for manual sound control with volume control dial.

Tone Control Switch: NORMAL and BASS-CUT settings for controlling sound quality.

Cue Light: On front of camera. Flashes 8 times/sec. during filming and once/sec. during self-timer delay.

Accessory Shoe: For attaching the Boom Microphones or the Lighting Adapter LA-1.

Grip: Collapsible, hinges up sideways and lies upwards along the camera side; serves as battery compartment.

External Power Jack: Coaxial feed plug

fitting on the grip for an external 9V DC supply with Canon Power Pack 9V.

Tripod Attachment: Standard CU 1/4" socket.

Dimensions and Weight:

814 XL-S: 252.5 (L) \times 113.5 (H) \times 59.5 (W)mm. (9 - 15/16" \times 4 - 7/16" \times 2 - 5/16") when grip is folded. Hood and eyecup not included in the measurement. 2 kg (4lb 6oz) with batteries.

1014 XL-S: 264 (L) \times 113.5 (H) \times 59.5 (W)mm. (10 - 3/8" \times 4 - 7/16" \times 2 - 5/16") when grip is folded. Hood and eyecup not included in the measurement. 2.1 kg (4lb 10 - 1/2oz) with batteries.

Accessories: Remote Switch 60, Dynamic Microphone DM 40R, Earphone E, Action Strap II.

814 XL-S: Rubber Hood SC-62, 62mm Lens Cap, Step-up Ring 62-67.

1014 XL-S: Rubber Hood SC-67, 67mm Lens Cap.

Optional Items: Snap Case C8-1, Boom Microphones BM 50 and BM 70, Elec-

tret Condenser Mike CM 100, Power Pack 9V, Microphone Extension Cord E450Y, Lighting Adapter LA-1, Headphone HP-M, Wireless Controller LC-1, C-8 Wide Attachment 67, Tele-Converter 1.4 × 67, 67mm Close-up Lens 240 C-8, Gadget Bag GL-2, Chest Pod II, Remote Switch 3, Extension Cord E1000, Connecting Cord C300L, Wireless Receiver WR-50 Quartz, Wireless Microphone WM-50 Quartz.

814 XL-S: 62mm filters.

1014 XL-S: 72mm filters (for use on Rubber Hood SC-67).

Subject to change without notice.

NOTE: Among the optional items, Headphone HP-M, Gadget Bag GL-2, Wireless Receiver WR-50 Quartz and Wireless Microphone WM-50 Quartz are not available in some markets.

Dynamic Microphone DM 40R

Composition: Microphone and microphone stand.

Type: Omnidirectional dynamic microphone with built-in wind screen.

Output Impedance: 400Ω

Output Level: -78dB ± 3dB (0dB = 1V/μBAR)

Plug: φ3.5 mm mini-plug for microphone and φ2.5 mm mini-plug for remote control. Y-shaped cord end for individual connections to jacks.

Remote Switch: Provided (ON by applying pressure to switch, OFF by removing pressure from switch.)

Cord Length: 4.5 m

Dimensions and Weight: φ33 mm (max. width) × 165 mm (length) not including stand. 120 g (w/cord)

Subject to change without notice.

Canon

CANON INC. 7-1, Nishi-Shinjuku 2-Chome, Shinjuku-ku, Tokyo 160, Japan
Mailing address: P.O. Box 5050, Dai-ichi Seimei Building, Tokyo 160, Japan

- U.S.A.** **CANON U.S.A., INC. HEADQUARTERS**
One Canon Plaza, Lake Success, N.Y. 11042, U.S.A.
CANON U.S.A., INC. MANHATTAN SERVICE CENTER
600 Third Avenue, New York, N.Y. 10016, U.S.A.
CANON U.S.A., INC. ATLANTA BRANCH
5380 Peachtree Industrial Blvd., Norcross, Georgia 30071, U.S.A.
CANON U.S.A., INC. CHICAGO BRANCH
140 Industrial Drive, Elmhurst, Illinois 60126, U.S.A.
CANON U.S.A., INC. LOS ANGELES BRANCH
123 Paulerino Avenue East, Costa Mesa, California 92626, U.S.A.
CANON U.S.A., INC. LOS ANGELES SERVICE CENTER
3321 Wilshire Blvd., Los Angeles, California 90010, U.S.A.
CANON U.S.A., INC. SAN FRANCISCO OFFICE
776 Market Street, San Francisco, California 94102, U.S.A.
CANON U.S.A., INC. DALLAS OFFICE
2035, Royal Lane, Suite 290, Dallas, Texas 75229, U.S.A.
CANON U.S.A., INC. HONOLULU OFFICE
Bldg. B-2, 1050 Ala Moana Blvd., Honolulu, Hawaii 96814, U.S.A.
- CANADA** **CANON CANADA INC. HEADQUARTERS**
3245 American Drive, Mississauga, Ontario L4V 1N4, Canada
CANON CANADA INC. MONTREAL SERVICE CENTRE
10652 Côte de Liesse, Lachine, Quebec H8T 1A5, Canada
CANON CANADA INC. CALGARY OFFICE
2828, 16th Street, N.E. Calgary, Alberta T2E 7K7, Canada
- EUROPE, AFRICA & MIDDLE EAST** **CANON EUROPA N.V.**
P.O. Box 7907, 1008 AC Amsterdam, The Netherlands
CANON FRANCE-PHOTO CINEMA S.A.
30, boulevard Vital-Bouhot, Ile de la Jatte, 92521 Neuilly-sur-Seine, France
CANON UK LTD.
Units 4 & 5, Brent Trading Centre, North Circular Road, London NW10 0JF, United Kingdom
- CENTRAL & SOUTH AMERICA** **CANON LATIN AMERICA, INC. DEPTO. DE VENTAS**
Apartado 7022, Panamá 5, República de Panamá
CANON LATIN AMERICA, INC. CENTRO DE SERVICIO Y REPARACION
Apartado 2019, Zona Libre de Colón, República de Panamá
- SOUTHEAST ASIA** **CANON HONGKONG TRADING CO., LTD.**
Golden Bear Industrial Centre, 7/F, 66-82 Chai Wan Kok Street,
Tsuen Wan, New Territories, Hong Kong
CANON SINGAPORE PTE. LTD.
60-B Martin Road, #10-01/0B, Singapore Warehouse, Block C, Singapore 0923
- OCEANIA** **CANON AUSTRALIA PTY. LTD.**
Unit 1/37, Waterloo Road, North Ryde (Macquarie Park), N.S.W. 2113, Australia
- JAPAN** **CANON SALES CO., INC.**
11-28, Mita, 3-Chome, Minato-ku, Tokyo 108, Japan