

Data Projector

Operating Instructions

Before operating the unit, please read this manual and supplied Quick Reference Manual thoroughly and retain it for future reference.

VPL-FHZ55

HDMI

Table of Contents

Overview

Location and Function of Controls	3
Main Unit	3
Connector Panel	4
Remote Commander and Control Panel	5

Preparation

Connecting the Projector	8
Connecting a Computer	8
Connecting Video Equipment	9
Connecting an External Monitor and Audio Equipment	11

Projecting/Adjusting an Image

Projecting an Image	12
Adjusting the Focus, Size, and Position of the Projected image	13
Turning Off the Power	17

Adjustments and Settings Using a Menu

Using a MENU	18
The Picture Menu	19
The Screen Menu	21
The Function Menu	24
The Operation Menu	25
The Connection/Power Menu	26
The Installation Menu	28
The Information Menu	31

Network

Using Network Features	32
Displaying the Control Window of the Projector with a Web Browser	32
Confirming the Information regarding the Projector	33
Operating the Projector from a Computer	33
Using the e-mail report Function	33

Others

Indicators	35
Messages List	36
Troubleshooting	37
Cleaning the Air Filter	39
Specifications	40
Projection Distance and Lens Shift Range	46
Dimensions	48
Index	52

Location and Function of Controls

Main Unit

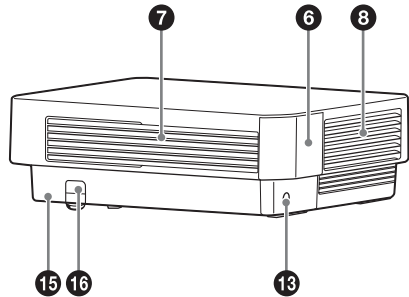
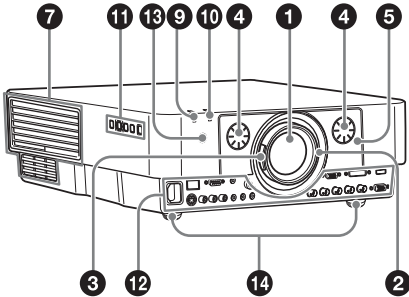

- 1 Lens
- 2 Focus ring (page 13)
- 3 Zoom lever (page 13)
- 4 Lens shift dial (page 13)
- 5 Front panel
- 6 Air filter cover (page 39)
- 7 Ventilation holes (intake)
- 8 Ventilation holes (exhaust)

Caution

Do not place anything near the ventilation holes as this may cause internal heat buildup. Do not place your hand near the ventilation holes (exhaust) and the circumference as this may cause injury.

- 9 ON/STANDBY indicator (page 35)
- 10 WARNING indicator (page 35)
- 11 Control panel (page 5)

- 12 Connector panel (page 4)
- 13 Remote control detector
The remote control detectors are located at the front and rear of the projector.
- 14 Front feet (adjustable) (page 13)
- 15 Antitheft lock
Connects to an optional antitheft cable manufactured by Kensington. For details, visit the Kensington's web site. <http://www.kensington.com/>
- 16 Antitheft bar
Connects to a commercially available antitheft chain or wire.

Connector Panel

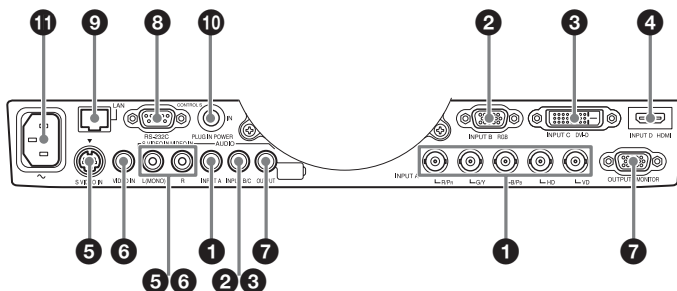

Input (page 8)

- 1 INPUT A**
Video: RGB/YPbPr input connector (RGB HD VD/YPbPr)
Audio: Audio input connector (AUDIO)
- 2 INPUT B**
Video: RGB input connector (RGB)
Audio: Audio input connector (AUDIO)
- 3 INPUT C**
Video: DVI-D input connector (DVI-D)
Audio: Audio input connector (AUDIO)
- 4 INPUT D**
Video: HDMI input connector (HDMI)
Audio: HDMI input connector (HDMI)
- 5 S VIDEO (S VIDEO IN)**
Video: S video input connector
Audio: Audio input connector (AUDIO L [MONO]/R)
- 6 VIDEO (VIDEO IN)**
Video: Video input connector
Audio: Audio input connector (AUDIO L [MONO]/R)

Notes

- The audio input connectors of the projector are for output to external equipment. Connect external audio equipment to output an audio (page 11).
- The audio inputs of INPUT B and INPUT C are shared. The audio inputs of S VIDEO and VIDEO are also shared.

Output (page 11)

- 7 OUTPUT**
Video: Monitor output connector (MONITOR)
Audio: Audio output connector (AUDIO)

Note

This connector outputs the projected image or audio. The image is output as a computer signal input from the RGB input connector (INPUT A, INPUT B) or a video signal input from the YPbPr input connector (INPUT A).

Others

- 8 RS-232C connector**
RS-232C compatible control connector
- 9 LAN connector (page 32)**
- 10 CONTROL S input connector (DC power supply) (CONTROL S IN PLUG IN POWER)**
Connects to the CONTROL S output connector on the supplied Remote Commander with a connecting cable (stereo mini plug (not supplied)) when using it as a wired Remote Commander. You do not need to install batteries in the Remote Commander, as the power is supplied from this connector.
- 11 AC IN (~) socket**
Connects the supplied AC power cord.

Remote Commander and Control Panel

Remote Commander

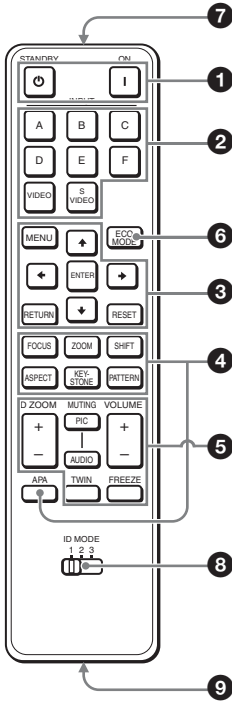

Control Panel

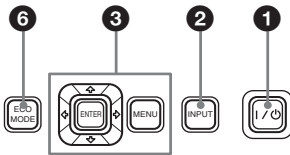

1 Turning on the power/Going to standby

- I (On) key
- ⏻ (Standby) key

2 Selecting an input signal (page 12)

INPUT key (main unit)
Direct input select keys (Remote Commander)

The E and F keys are not used with this projector.

3 Operating a menu (page 18)

ENTER /▲/▼/◀/▶ (arrow) keys
MENU key
RETURN key
RESET key

4 Adjusting the image (page 13)

FOCUS key
 This function is not provided in this projector.

ZOOM key
 This function is not provided in this projector.

SHIFT key
 This function is not provided in this projector.

ASPECT key (pages 21, 23)
 Changes the aspect ratio of the projected image.

KEYSTONE key (page 13)

PATTERN key (page 13)

APA (Auto Pixel Alignment) key*
 Automatically adjusts a picture to its clearest while a signal is input from a computer. You can cancel the adjustment by pressing the APA key again while adjusting.

Note

* Use this key when inputting a computer signal via the RGB input connector (INPUT A, INPUT B).

5 Using various functions during projecting

D ZOOM (Digital Zoom) +/- key*¹
 Enlarges a portion of the image while projecting.

- 1 Press the D ZOOM + key to display the digital zoom icon on the projected image.
- 2 Press the ▲/▼/◀/▶ keys to move the digital zoom icon to the point on the image you wish to enlarge.
- 3 Press the D ZOOM + key or the D ZOOM – key repeatedly to change the enlargement ratio. The image can be enlarged up to 4 times.

Press the RESET key to restore the previous image.

TWIN (Twin Picture) key

You can project the images from two input signals on the screen as a main picture and subpicture at the same time. To switch between one and two pictures, press the TWIN key on the Remote Commander.

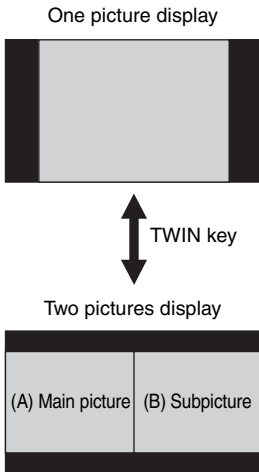

You can select the image to project to the main picture.

The subpicture is preset to display the image from INPUT B.

For details on combinations of input signals, see “Combinations of Input Signals” on page 45.

Notes

- When displaying two pictures, the I (On) key, ⏻ (standby) key, INPUT key, and MUTING (PIC) key are available.
- When “Screen Aspect” (page 29) is set to “4:3,” the two picture function is not available.

- When displaying two pictures, the input signal icon  does not appear in the input select window (page 12).
- Picture settings set for one picture may not be reflected as two pictures.

MUTING key

PIC: Cuts off the image. Press again to restore the image.

AUDIO: Mutes the audio output. Press again to restore the previous volume.

VOLUME +/- key

For adjusting the volume output from the audio output connector of the projector.

FREEZE key*2

Pauses a projected image. Press again to restore the image.

Notes

*1: Use this key when inputting a computer signal. But it may not be enabled, depending on the resolution of the input signal and when displaying two pictures.

*2: Use this key when inputting a computer signal.

6 Setting the energy-saving mode easily

ECO MODE key

Energy-saving mode can be set easily. Energy-saving mode consists of “Light Output Mode,” “Constant Brightness,” “With No Input,” “With Static Signal” and “Standby Mode.”

- 1 Press the ECO MODE key to display the ECO Mode menu.

ECO Mode Menu

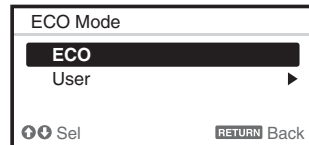

- 2 Press the ▲/▼ key or ECO MODE key to select ECO or User mode.

ECO: Sets each mode to the optimum energy-saving value.

Light Output Mode: Standard

Constant Brightness: On

With No Input: Standby
 With Static Signal: Light
 Dimming
 Standby Mode: Low
 (go to step 6)

User: Sets each item of the energy-saving mode menu as you desire (go to step 3).

- 3 Select "User" then press the **▶** key. The setting items appear.

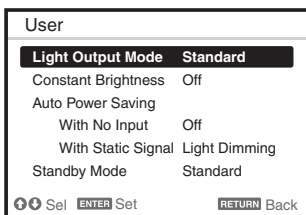

- 4 Press the **▲/▼** key to select the ECO Mode item then press the **▶** key or the ENTER key.
- 5 Press the **▲/▼** key to select the setting value.
- 6 Press the RETURN key to restore the previous image.

For details on ECO Mode settings, see "Light Output Mode", "With No Input", "With Static Signal" and "Standby Mode" on the Connection/Power menu (page 26).

About Remote Commander operation

- Direct the Remote Commander toward the remote control detector.
- The shorter the distance between the Remote Commander and the projector is, the wider the angle within which the Remote Commander can control the projector becomes.
- If there is any obstruction between the Remote Commander and the remote control detector on the projector, the projector may not be able to receive signals from the Remote Commander.

Others

7 Infrared transmitter

8 ID MODE 1/2/3 switch (page 25)

Sets an ID mode of the Remote Commander. If you assign a different ID number to each projector when multiple projectors are used, you can control only the projector with the same ID mode as that of the Remote Commander.

9 CONTROL S output connector

Connects to the CONTROL S input connector on the projector with a connecting cable (stereo mini plug (not supplied)) when using the Remote Commander as a wired one.

You do not need to install batteries in the Remote Commander, as the power is supplied from the projector.

Connecting the Projector

Notes

- Turn off all equipment before making any connections.
- Use the proper cables for each connection.
- Insert the cable plugs firmly; Loose connections may reduce performance of picture signals or cause a malfunction. When pulling out a cable, be sure to grip it by the plug, not the cable itself.
- For more information, refer also to the instruction manuals of the equipment you are connecting.
- Use a no-resistance audio cable.

Connecting a Computer

Connection with a computer is explained for each input signal.

INPUT A

For connection when there is a long distance between a computer and the projector.

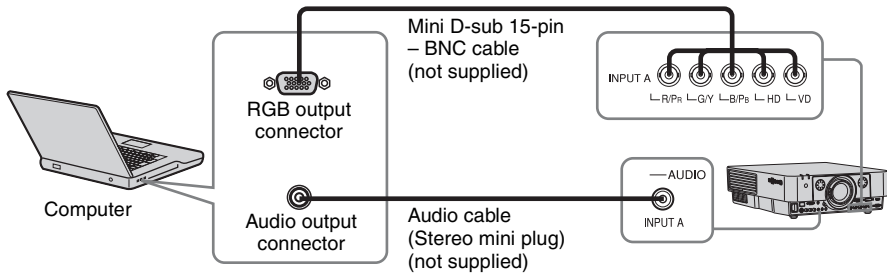

INPUT B

For connecting a computer with an RGB output connector.

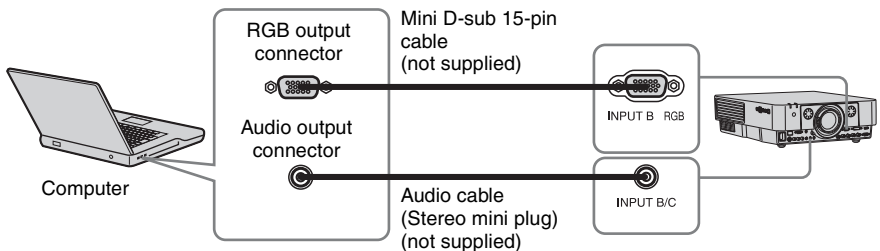

Note

It is recommended that you set the resolution of your computer to 1920 × 1200 pixels for the external monitor.

INPUT C

For connecting a computer with a DVI-D output connector.

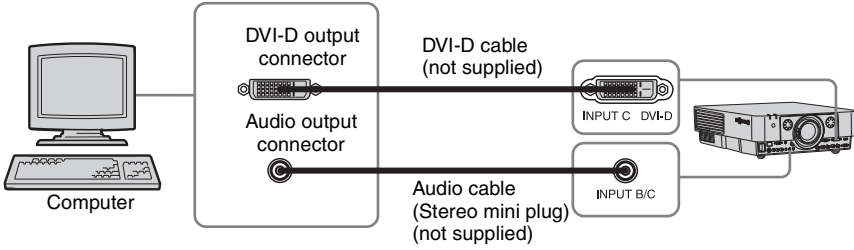

INPUT D

For connecting a computer with an HDMI output connector.

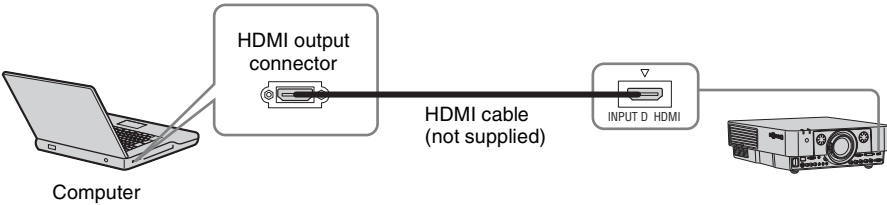

Notes

- The HDMI connector of this projector is not compatible with DSD (Direct Stream Digital) Signal or CEC (Consumer Electronics Control) Signal.
- Be sure to use the HDMI cable with an HDMI logo.

Connecting Video Equipment

Connections with a VHS videocassette recorder, DVD player, or BD player are explained for each input signal.

S VIDEO IN

For connecting video equipment with an S-video output connector.

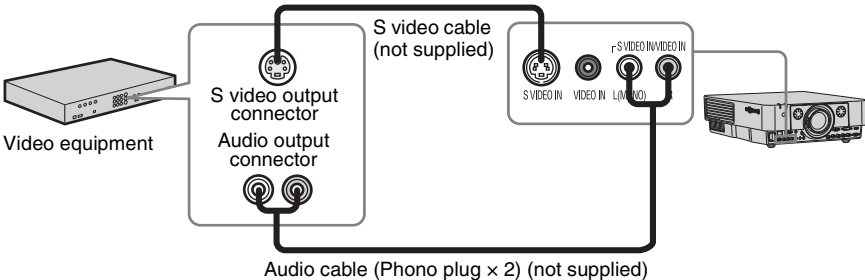

VIDEO IN

For connecting video equipment with a video output connector.

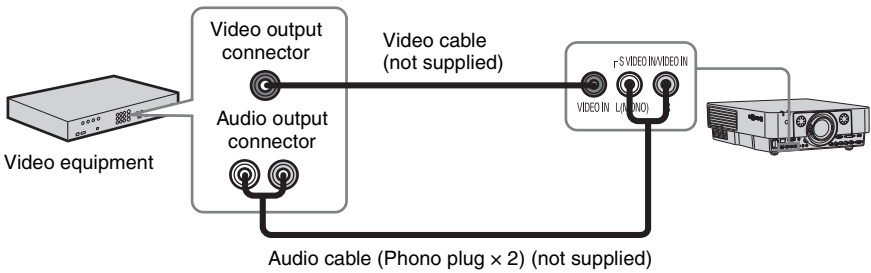

INPUT A

For connection when there is a long distance between the video equipment and projector.

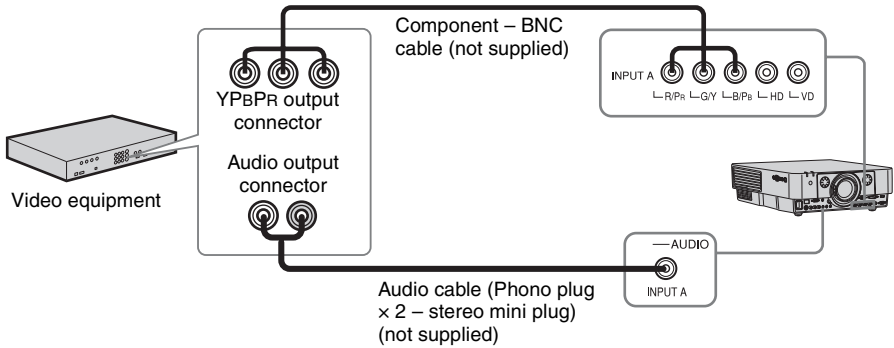

INPUT D

For connecting video equipment with an HDMI output connector.

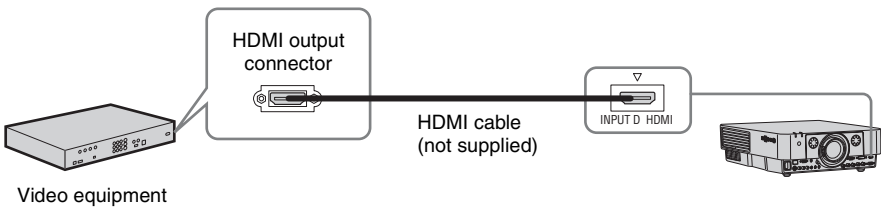

Notes

- The HDMI connector of this projector is not compatible with DSD (Direct Stream Digital) Signal or CEC (Consumer Electronics Control) Signal.
- Be sure to use the HDMI cable with an HDMI logo.

To fix the HDMI cable

Fix the cable to the cable tie holder at the bottom of the projector, using a commercially available cable tie, as in the illustration.

Use a cable tie of less than 1.9 mm × 3.8 mm in thickness.

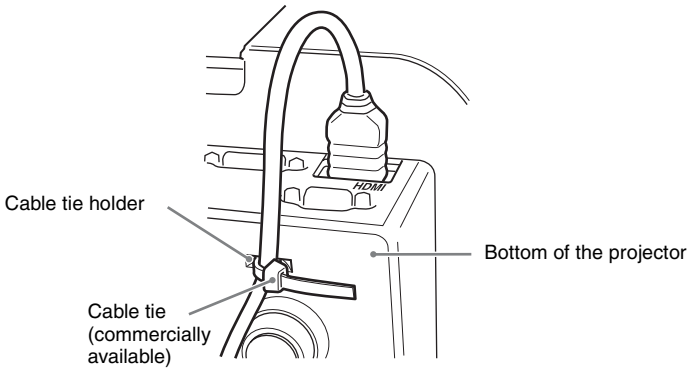

Connecting an External Monitor and Audio Equipment

OUTPUT

Projected images and input audio can be output to display equipment such as a monitor and audio equipment such as speakers with a built-in amplifier.

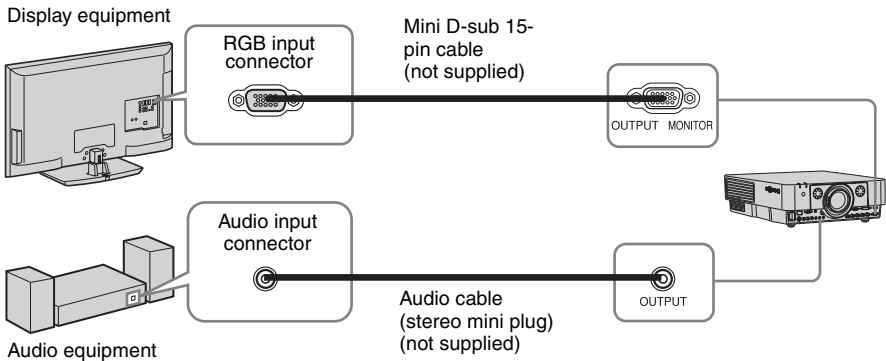



Note

This connector outputs the projected image or audio. The image is output as a computer signal input from the RGB input connector (INPUT A, INPUT B) or a video signal input from the YPBPR input connector (INPUT A).

Projecting an Image

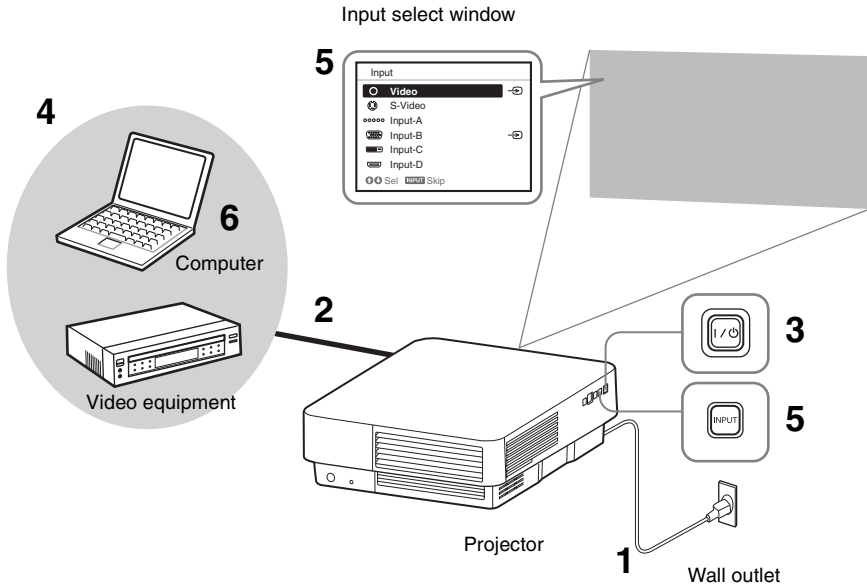
The size of a projected image depends on the distance between the projector and screen. Install the projector so that the projected image fits the screen size. For details on projection distances and projected image sizes, see “Projection Distance and Lens Shift Range” (page 46).



- 1 Plug the AC power cord into a wall outlet.
- 2 Connect all equipment to the projector (page 8).
- 3 Turn on the projector.
Press the I/⏻ key on the main unit or the I key on the Remote Commander.
- 4 Turn on the connected equipment.
- 5 Select the input source.
Press the INPUT key on the projector to display the input select window. Press the INPUT key repeatedly or the ⬆/⬇ key to select an image to be projected. The signal icon  appears on the right side in the input select window when a signal is input.

You can select the input source using Direct input select keys on the Remote Commander (page 5).



- 6 Switch your computer to output to external display by changing your computer's setting.
How to switch the computer to output to the projector varies, depending on the type of computer.

(Example)

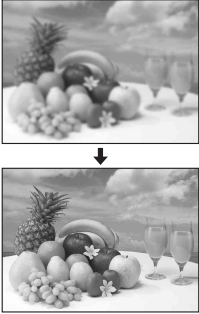

- 7 Adjust the focus, size, and position of the projected image (page 13).

Adjusting the Focus, Size, and Position of the Projected image

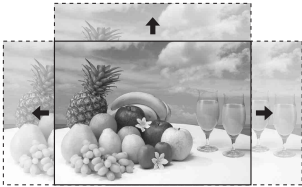
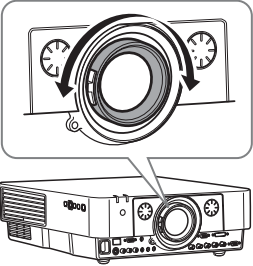
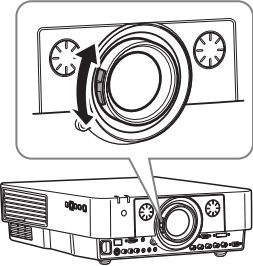
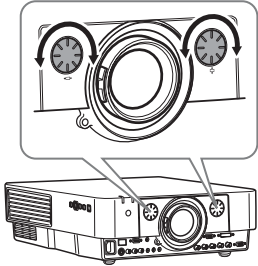
Focus	Size (Zoom)	Position (Lens shift)
		
		

Adjusting the tilt of the projector with the front feet (adjustable)

When the projector is installed on an uneven surface or the projected position is low, you can adjust using the front feet (adjustable). To correct any trapezoidal distortion of the projected image, use the Keystone correction feature (pages 13, 28).

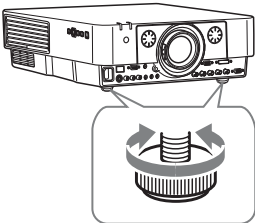

Notes

- Be careful not to let the projector down on your fingers.

- Do not push hard on the top of the projector with the front feet (adjustable) extended.
- Keystone adjustment is an electronic correction. Consequently the image quality may deteriorate.

Displaying a pattern for adjusting an image

You can display a pattern for adjusting the projected image with the PATTERN key on the Remote Commander. Press the PATTERN key again to restore the previous image.

Correcting for trapezoidal distortion of the projected image (Keystone adjustment)

If the screen is tilted, or you are projecting from an oblique angle, perform keystone adjustment.

1 Press the KEYSTONE key on the Remote Commander once or select “V Keystone” in the Installation menu to display the adjustment menu.

2 Adjust the value using $\uparrow/\downarrow/\leftarrow/\rightarrow$.
The higher the setting, the narrower the top of the projected image. The lower the setting, the narrower the bottom of the projected image.

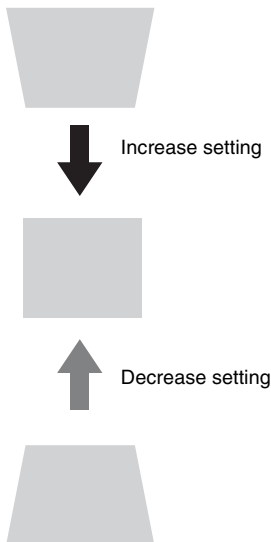

If the projected image is trapezoidally-distorted in the lateral plane

1 Press the KEYSTONE key on the Remote Commander twice, or select “H Keystone” in the Installation menu to display the adjustment menu.

2 Adjust the value using $\uparrow/\downarrow/\leftarrow/\rightarrow$.
The higher the setting, the narrower the right side of the projected image. The lower the setting, the narrower the left side of the projected image.

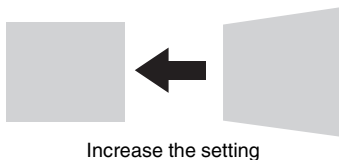
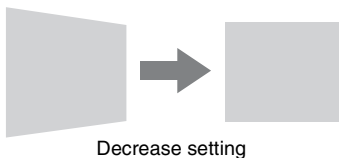

Notes

- Keystone adjustment is an electronic correction. Consequently the image quality may deteriorate.
- Depending on the position adjusted with the lens shift feature, using the Keystone feature may change the aspect ratio of the original image, or the projected image may be distorted.
- If keystone correction is performed using the KEYSTONE key, the Warp correction feature (if enabled) will be canceled.

Correcting image twist (Warp correction feature)

You can correct image twist with the warp correction feature.

1 Press the KEYSTONE key on the Remote Commander three times, or select “Warping” in the Installation menu, then select “Adjust.”
The guide is displayed.

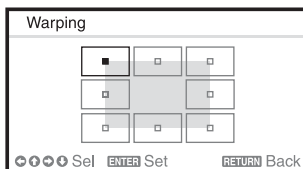

Selecting the corner(s) of the image to be corrected

1 Move \blacksquare using $\uparrow/\downarrow/\leftarrow/\rightarrow$ to select the corner you want to correct.

- 2** Press the ENTER key.
The cursor appears.

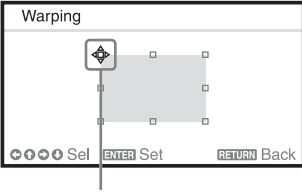

Adjust using this cursor

- 3** Adjust the position of the corner you want to correct, using $\uparrow/\downarrow/\leftarrow/\rightarrow$.

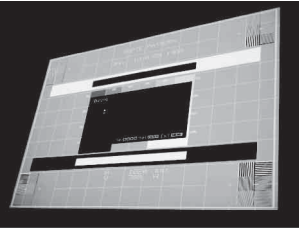

The cursor will disappear when the deflection range limit is reached.

Example of cursor display:



Adjust in all directions



Leftward, rightward or downward adjustment only

Correcting deflection ① – left/right sides of the image

- 1** Move ■ using $\uparrow/\downarrow/\leftarrow/\rightarrow$ to select the side you want to correct.

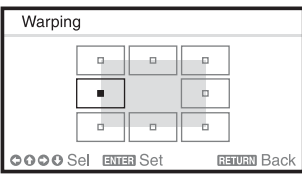

- 2** Press the ENTER key.
The cursor appears.

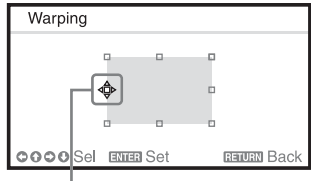

Adjust using this cursor

- 3** You can adjust the deflection of the side, using $\uparrow/\downarrow/\leftarrow/\rightarrow$.
You can adjust the center point of deflection using \uparrow/\downarrow . For the range of deflection, use \leftarrow/\rightarrow . You can adjust the left/right side independently.

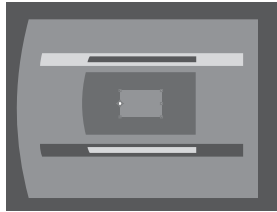
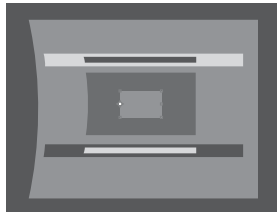

The cursor will disappear if the deflection range limit is reached.

Example of cursor display:



Adjust in all directions



Upward, downward, or rightward adjustment only

Correcting deflection ② – top/bottom sides of the image

- 1** Move ■ using $\uparrow/\downarrow/\leftarrow/\rightarrow$ to select the side you want to correct.

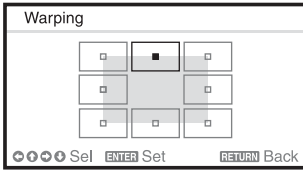

- 2 Press the ENTER key.
The cursor appears.

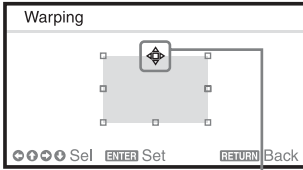

Adjust using this cursor

- 3 You can adjust the deflection of the side, using $\uparrow/\downarrow/\leftarrow/\rightarrow$.
You can adjust the center point of deflection using \leftarrow/\rightarrow . For the range of deflection, use \uparrow/\downarrow . You can adjust the top/bottom independently.

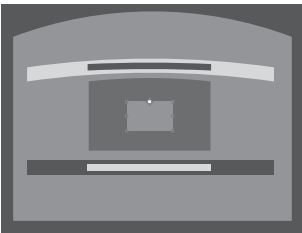
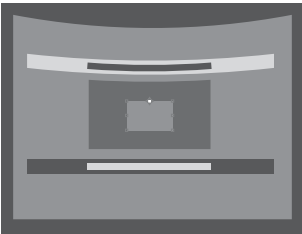

The cursor will disappear if the deflection range limit is reached.

Example of cursor display:



Adjust in all directions



Leftward, rightward or downward adjustment only

Setting the blending function to project from multiple projectors

- 1 Install the projectors.
Input a pattern, etc., to adjust the projected positions from multiple projectors.
Set a different ID mode for each projector (page 25).
- 2 Enable the Edge Blending function.
Display the main menu to set “Edge Blending” to “On” in the Installation menu.
- 3 Set the position of blending.
Choose the position (top/bottom/left/right) for blending.
- 4 Assign the blending width.
Set the blending width according to the overlapping range for the source signal.

Assign the position and width here.

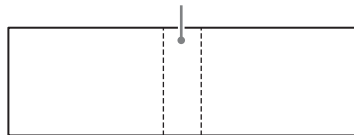

- 5 Adjust using “Zone Black Level Adj.”

Adjust each correction zone by “Zone Black Level Adj.” for the most uniform black level between each zone.
During this adjustment, a black image is automatically projected.

6 Set “Blend Gamma.”

Select the gamma mode in which the overlapping of images is least noticeable.

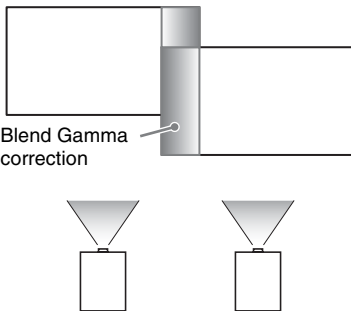

Notes

- The procedure shown above is for general guidance. Your own installation may vary according to the situation.
- In case of multiple projectors, use the color matching function (page 30) to adjust for differences in color and brightness. Note that more detailed adjustment for Edge Blending is possible using a PC application. For more details, consult with qualified Sony personnel.
- When multiple projectors are set up in a line, the temperature inside the projectors may increase due to exhaust vent proximity, and an error indication may result. In this case, space the projectors farther apart and/or install deflection partitioning between them. For more details, consult with qualified Sony personnel.

Turning Off the Power

- 1 Press the **I/⏻** key on the main unit or the **⏻** key on the Remote Commander. The projector starts shutdown and turns off. If you press the **I/⏻** key on the main unit or the **I** key on the Remote

Commander within 5 seconds again, shutdown is cancelled.

- 2 Unplug the AC power cord from the wall outlet.

To turn off without displaying confirmation message

Press and hold the **I/⏻** key on the main unit for a few seconds (page 36).

ECO gauge

This gauge indicates the current effectiveness of the projector’s ECO function. (For details on the ECO function, see “ECO MODE key” (page 6) and “ECO” (page 26).)

The leaf icons are displayed when the projector is shut down. The number of displayed icons varies according to how much energy is saved as a result of using the ECO function.



Using a MENU

Note

The menu displays used for the explanation below may be different depending on the model you are using.

- 1 Press the MENU key to display the menu.
- 2 Select the setting menu.
Use the \uparrow or \downarrow key to select the setting menu, then press \rightarrow or ENTER key.

Setting menu

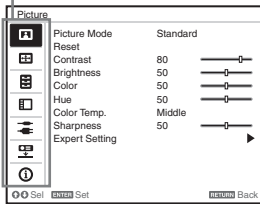

- 3 Select the setting item.
Use the \uparrow or \downarrow key to select the setting menu, then press \rightarrow or ENTER key.
To return to the selection screen of the setting menu, press the \leftarrow key or the RETURN key.

Setting items

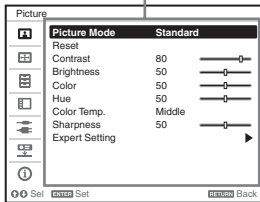

- 4 Make the setting or adjustment for the selected item.
Menu operation differs depending on the setting item. If the next menu window is displayed, select the item according to the operations in step 3 and then press the ENTER key to register the setting.

To return to the selection screen of the setting items, press the \leftarrow key or the RETURN key. Also, to reset the setting value of an item to its factory preset value, press the RESET key during setting or adjusting.

Using a pop-up menu

Press the $\uparrow/\downarrow/\leftarrow/\rightarrow$ key to select an item. Press the ENTER key to register the setting. The previous screen is restored.

Selecting items

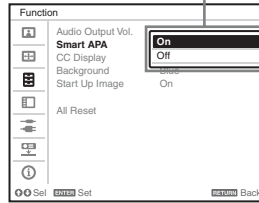

Using the setting menu

Press the \uparrow or \downarrow key to select the item. Press the ENTER key to register the setting. The previous screen is restored.

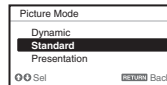

Using the adjustment menu

To increase the number, press the \uparrow or \rightarrow key and to decrease the number, press the \downarrow or \leftarrow key. Press the ENTER key to register the setting. The previous screen is restored.



- 5 Press the MENU key to clear the menu.
The menu disappears automatically if no key is pressed for a while.

The Picture Menu

For adjusting the picture for each input signal.

Setting items	Description
Picture Mode	Dynamic: Emphasizes the contrast to produce a “dynamic” picture. Standard: Makes the picture be natural and well balanced. Presentation^{*1}: Makes the picture bright to suit for a presentation.
Reset	The picture settings are initialized to their factory preset values. However, “Picture Mode” and “Custom1,” “Custom2,” and “Custom3” of “Color Temp.” do not return to the factory preset values.
Contrast	The higher the setting, the greater the contrast. The lower the setting, the lower the contrast.
Brightness	The higher the setting, the brighter the picture. The lower the setting, the darker the picture.
Color ^{*2 *4}	The higher the setting, the greater the intensity. The lower the setting, the lower the intensity.
Hue ^{*2 *4 *5}	The higher the setting, the more greenish the picture becomes. The lower the setting, the more reddish the picture becomes.
Color Temp. ^{*3}	High/Middle/Low: The higher the temperature, the more bluish the picture. The lower the temperature, the more reddish the picture. Custom1/ Custom2/ Custom3: An adjusted color temperature setting can be stored for each item. The factory settings are Custom1: High, Custom2: Middle, Custom3: Low.
Sharpness ^{*6}	The higher the setting, the sharper the picture. The lower the setting, the softer the picture.
Expert Setting	
Film Mode ^{*2 *7}	Auto: Precisely reproduces the image from a film source to suit the original film source. Normally, select this option. Off: Select this option if the images are rough around the edges when “Auto” is selected.
Black Level Adj. (Adjust) ^{*2}	High/Low/Off: Emphasizes dark portions of the projected image to suit your taste.
Gamma Mode ^{*1}	Graphics1: Improves the correction of halftones to give a brighter image. This can be useful when projecting colored images, such as photos, in a bright location. Graphics2: Improves the reproduction of halftones. This reproduces colored images, such as photos, in more natural tones. Text: Contrasts black and white. Suitable for images that contain lots of text. DICOM GSDF Sim.^{*8}: Gamma setting is in accordance with the Grayscale Standard Display Function (GSDF) of the Digital Imaging and Communications in Medicine (DICOM) standards.

Notes

- *1: When a computer signal is input, this option is available.
- *2: When a video signal is input, this option is available.
- *3: When “Picture Mode” is set to the item other than “Presentation,” this option is available.
- *4: When a B & W signal is input, this option is not available.

- *5: When an analog TV signal is input, this option may not be available, depending on the color system.
- *6: When a video signal is input, this option is available.
- *7: When a progressive signal is input, this option is not available.
- *8: Available when a computer signal is input from the DVI-D input connector (INPUT C) and HDMI input connector (INPUT D). This projector is not to be used as a device for medical diagnosis.

The Screen Menu

For adjusting the size, position, and aspect ratio of the projected image for each input signal.

Setting items	Description
Aspect ^{*1}	Changes the aspect ratio of the projected image (page 23).
When the computer signal is input	<p>Full1: Displays the image to fit the maximum projected image size without changing the aspect ratio of the input signal.</p> <p>Full2: Displays the image to fit the maximum projected image size.</p> <p>Normal: Displays the image on the center point of the projected image without changing the resolution of the input signal or enlarging the image.</p>
When the video signal is input	<p>4:3: Displays the image to fit the maximum projected image size with an aspect ratio fixed to 4:3.</p> <p>16:9: Displays the image to fit the maximum projected image size with an aspect ratio fixed to 16:9.</p> <p>Full: Displays the image to fit the maximum projected image size.</p> <p>Zoom: Display the center point of the projected image to zoom.</p>
V Center ^{*2}	Adjust the whole projected image by moving up and down on the screen. As the selected number increases, the screen moves up, and as the selected number decreases, the projected image moves down.
Vertical Size ^{*2}	Reduces or enlarges the image vertically. The projected image is enlarged as the setting increases and reduced as the setting decreases. If the subtitle of a movie, etc. cannot be seen, use this together with “V Center.”
Over Scan ^{*2}	On/Off: Hides the outline of the image when set to “On.” Select “On” if noise appears along the edge of the image.
Adjust Signal ^{*5}	Adjusts the image of a computer signal. Use this item if the edge of the image is cut and reception is bad.
APA ^{*3 *4}	Automatically adjusts the projected image to an optimum quality when you press the ENTER key.
Phase ^{*3}	Adjusts the dot phase of the display pixel and the input signal. Set to the value where looks clearest.
Pitch ^{*3}	The higher the setting, the wider the horizontal image elements (pitch). The lower the setting, the narrower the horizontal image elements (pitch).
Shift ^{*5}	<p>H: The higher the setting, the farther right the image is projected on the screen. The lower the setting, the image farther left.</p> <p>V: The higher the setting, the farther up the image is projected on the screen. The lower the setting, the image farther down.</p>

Notes

- *1: • Note that if the projector is used for profit or for public viewing, modifying the original picture by switching to the aspect mode may constitute an infringement of the rights of authors or producers, which are legally protected.
- Depending on the input signal, setting items for aspect ratio or some other setting items cannot be set in some cases, or changing the aspect ratio setting may have no effect.
- A part of the image may be displayed in black, depending on the setting item.
- *2: Available when a video signal is input from the YPBPr input connector (INPUT A), DVI-D input connector, and HDMI input connector.

- *3: Available when a computer signal is input from the RGB input connector (INPUT A, INPUT B).
- *4: If the projected image includes a large amount of black portion around it, the APA function will not work properly and a part of the image may not be displayed on the screen. In addition, an optimum image cannot be obtained, depending on the type of input signal. In this case, adjust the “Phase,” “Pitch,” and “Shift” items manually.
- *5: Available when a computer signal is input from the RGB input connector (INPUT A, INPUT B) or a video signal is input from the YPBPr input connector (INPUT A). This option is available only when “Aspect” is set to “Zoom.”

Aspect

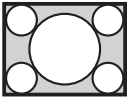
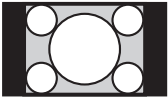
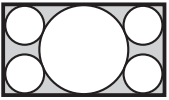
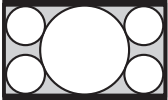
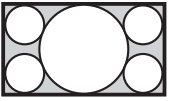
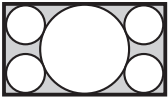
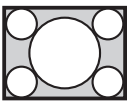
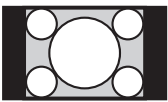
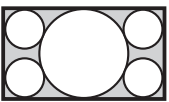
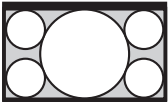
	Input signal	Recommended setting value and projected image
Computer signal	(4:3) 	(Full1) ^{*1 *2} 
	(16:9) 	(Full1) ^{*1 *2} 
	(16:10) 	(Full1) ^{*1} 
Video signal	(4:3) 	(4:3) ^{*3 *5} 
	(16:9) 	(16:9) ^{*4 *5} 

*1: If you select “Normal,” the image is projected in the same resolution as the input signal without changing the aspect ratio of the original image.



*2: If you select “Full2,” the image is projected to fit the projected image size, regardless of the aspect ratio of the image.



*3: Depending on the input signal, the projected image may be projected as illustrated below. In this a case, select “16:9.”



*4: Depending on the input signal, the image may be projected as illustrated below. In this a case, select “Zoom.”



*5: If you select “Full,” the image is projected to fit the projected image size, regardless of the aspect ratio of the image.



The Function Menu

The Function menu is used for setting various functions of the projector.

Setting items	Description
Audio Output Vol.	The higher the setting, the higher an audio level output from the audio output connector. The lower the setting, the lower the audio level.
Smart APA	On/Off: When set to “On,” executes APA automatically when a signal is input.*1
CC Display	CC1/CC2/CC3/CC4/Text1/Text2/Text3/Text4: Select the closed caption service (Captions or Text). Off: Closed caption does not appear.
Background*2	Blue/Black/Image: Sets the background for when there is no input signal. When set to “Image,” the Start Up Image is displayed.
Start Up Image	On/Off: When set to “On,” the Start Up Image is displayed on the screen upon startup of the projector.
All Reset	All settings are initialized to their factory preset values.

Notes

- *1: Executes APA when a computer signal is input via the RGB input connector (INPUT A, INPUT B).
- *2: When using the Twin Picture display mode and there is no input signal, the background will be black if you set this item to “Image”.

The Operation Menu

The Operation menu is used for setting for the operations by using the menu or the Remote Commander.

Setting items	Description
Language	Selects the language used in the menu and on-screen displays.
Menu Position	Bottom Left/Center: For selecting the position of the menu displayed on the projected image.
Status	On: All on-screen statuses are enabled. Off: Displays only the menus, the message when turning off the power, and warning messages.
IR Receiver	Front & Rear/Front/Rear: Selects the remote control detectors (IR Receiver) on the front and rear of the projector.
ID Mode	All/1/2/3: Assigns an ID number to the projector. When set to “All,” you can control the projector with the Remote Commander independently of the assigned ID Mode. Refer also to “ID MODE 1/2/3 switch” of the Remote Commander on page 7.
Security Lock*1	On/Off: This function enables restriction of the projector to authorized users by password. The setting procedures for security locking are as follows: <ol style="list-style-type: none">1 Select “On” then press the ENTER key to display the setting menu.2 Input the password with the MENU, / , and ENTER keys. (The default password setting is “ENTER, ENTER, ENTER, ENTER.”)3 Input a new password with the MENU, / , and ENTER keys.4 Enter the password again to confirm. Enter the password when you turn on the projector after disconnecting and reconnecting the AC power cord. When it is set to “Off,” you can cancel the security lock. You are required to input the password again. If you fail to enter the correct password after three consecutive times, the projector cannot be used. In this case, press the I/⏻ key to go standby mode then turn on the power again.
Panel Key Lock	On/Off: When set to “On,” locks all the control panel keys of the projector. However, you can enable operation by performing the following even when “Panel Key Lock” is set to “On.” <ul style="list-style-type: none">• Press and hold the I/⏻ key for approximately 10 seconds during standby mode.<ul style="list-style-type: none">→ The projector turns on.• Press and hold the MENU key for approximately 10 seconds during power on.<ul style="list-style-type: none">→ “Panel Key Lock” is set to “Off” and enables operation of all control panel keys on the projector.

Note

*1: You will not be able to use the projector if you forget your password. If you call qualified Sony personnel because you have forgotten the password, you will be asked to verify the projector’s serial number and your identity. (This process may differ in other countries/regions.) Once your identity has been confirmed, we will provide you with the password.

The Connection/Power Menu

The Connection/Power menu is used for setting for the connections and power.

Setting items	Description
Network Setting	
IPv4 Setting	
IP Address Setup	Auto (DHCP): The IP address is assigned automatically from the DHCP server such as a router. Manual: To specify the IP Address manually.
IP Address/ Subnet Mask/ Default Gateway/Primary DNS/Secondary DNS	When “Manual” is selected for “IP Address Setup,” select the item with the ◀ or ▶ key and input the value with ▲ or ▼ key. When all items are entered, select “Apply” then press the ENTER key. The entered settings will be registered.
IPv6 Information	Displays the IPv6 address information. When setting the address of IPv6, set it from the browser.
Input-A Signal Sel.	Auto/Computer/Video GBR/Component: When set to “Auto,” selects the type of video signal input automatically when “Input-A” is selected with the INPUT key.* ¹
Color System	Auto/NTSC3.58/PAL/SECAM/NTSC4.43/PAL-M/PAL-N: When set to “Auto,” selects the color system automatically when “S-Video” or “Video” is selected with the INPUT key.* ¹
ECO	
Light Output Mode	High/Standard/Auto/Custom * ² : When set to “High,” the image becomes brighter, and power consumption becomes higher. When set to “Standard,” power consumption becomes lower; however, the image will be darker. When set to “Auto,” brightness is adjusted automatically according to image content. Dark images are projected with brightness adjusted, leading to energy-saving. Bright images are projected brightly, without adjusting brightness. When set to “Custom;” you can adjust brightness as prefer.
Constant Brightness* ³	On/Off: Available when Light Output Mode is set to “High” or “Standard.” Brightness is constant at about 75% light output when Light Output Mode is set to “High,” and at about 55% when Light Output Mode is set to “Standard.”
Auto Power Saving	
With No Input	Light Cutoff: The light turns off automatically and power consumption is reduced if no signal is input for more than 10 minutes. The light turns on again when a signal is input or any key is pressed. In Light Cutoff, the ON/STANDBY indicator lights in orange. (page 35) If Light Cutoff continues for more than 30 minutes, the power will cut off automatically and the projector will go to standby mode. Standby * ⁴ : If no signal is input to the unit for more than 10 minutes, the power turns off automatically, and the unit enters standby mode. Off: The “With No Input” function is disabled.



Setting items	Description
With Static Signal	<p>Light Dimming^{*2 *5}: If an image does not change for about 10 seconds, light output is gradually reduced (approximately 10% to 15%^{*6}) from that set in the Light Output Mode. This setting provides a convenient way to reduce power consumption. Automatically the light slowly darkens to approximately 5% of its light output according to the selected time (with no change to input signal) “5,” “10,” “15,” “20” minutes or “Demo.” While dimming the light, the message “Light Dimming” appears. If you select “Demo,” the image will start to darken about 40 seconds later. When any change in signal is detected, or an operation (remote control or control panel) is performed, normal brightness is restored.</p> <p>Off: The “With Static Signal” function is disabled.</p>
Standby Mode ^{*7}	<p>Standard/Low: When set to “Low,” lowers power consumption in standby mode.</p>
Quick Reboot	<p>Off/10/30: After you turn off the power, the projector is in standby mode for a quick start within the specified time (10 minutes or 30 minutes). The ON/STANDBY indicator lights in orange when the projector is in standby mode. (page 35)</p>
Direct Power On	<p>On/Off: When set to “On,” you can turn the power on without going to standby mode when the AC power cord is connected to a wall outlet. You can also unplug the AC power cord without going to standby mode when you turn off the projector.</p> <p>You may unplug the AC power cord without going to standby mode.</p>

Notes

- *1: The image may not be adjusted properly depending on the type of input signal. In such a case, adjust it manually to suit to the connected equipment.
- *2: A change in signal may not be detected depending on the input image. If “With No Input” is set, it takes priority.
- *3: If the dust concentration is high, the projector may not maintain the function.
- *4: Select “Off” to avoid entering standby mode when there is no input signal.
- *5: As the light is dimmed gradually, you may not notice any change in brightness.
- *6: This varies depending on the “Light Output Mode” setting.
- *7: When “Standby Mode” is set to “Low,” the network and network control function cannot be operated while the projector is in standby mode.

The Installation Menu

The Installation menu is used for installing the projector.

Setting items	Description
Edge Blending	On/Off: When set to “On,” the Edge Blending function is enabled. Set to “Off” when you do not project using multiple projectors.
Blending Range	Sets the edge blending width. After selecting the blending position, a marker will be displayed. Top: Adjusts the top width of the screen. Bottom: Adjusts the bottom width of the screen. Left: Adjusts the left width of the screen. Right: Adjusts the right width of the screen.
Zone Black Level Adj. ^{*1} ^{*2}	Adjust so that the overlapped part is not noticeably bright when a dark image is displayed. Select the correction zone “Adjust Zone 1” through “Adjust Zone 9,” and set the adjustment values.
Blend Gamma	Sets the mode of the gamma curve of the overlapped area. Mode 1: Provides a gentle gamma correction curve. Mode 2:  Mode 3:  Mode 4:  Mode 5: Provides a sharp gamma correction curve.
Reset	Resets the adjusted values to their default values.
Image Split	Off/Left-side Area/Right-side Area: Divides the input signal from the computer in half, and displays an enlarged image of the left-side or right-side area on the screen. ^{*11}
Screen Fitting ^{*3}	HV Keystone/Warping: You can choose the way to correct image twist.
V Keystone ^{*4} ^{*5}	This is displayed when “HV Keystone” is selected in “Screen Fitting.” The higher the setting, the narrower the top of the projected image. The lower the setting, the narrower the bottom of the projected image.
H Keystone ^{*4} ^{*5}	This is displayed when “HV Keystone” is selected in “Screen Fitting.” The higher the setting, the narrower the right side of the projected image. The lower the setting, the narrower the left side of the projected image.
Warping ^{*5}	This is displayed when “Warping” is selected in “Screen Fitting.” Adjust: Corrects image twist. Reset: Resets the adjusted values to their default values.
Image Flip	HV/H/V/Off: Flips the projected image horizontally and/or vertically according to the installation method.

Setting items	Description
Installation Attitude	<p>Link to Image Flip/Right Side Up/Upside Down/Front Down/Front Up/Portrait 1/Portrait 2: Change the cooling setting to suit to the installation attitude. When set to “Link to Image Flip,” the cooling setting changes based on the setting of “Image Flip.”^{*6} Continuing to use the wrong setting may affect component reliability.</p> <div style="text-align: center;"> <p>The diagrams illustrate four installation attitudes for a projector. Under 'Horizontal installation', 'Right Side Up' shows the projector on the left projecting a beam to the right, and 'Upside Down' shows the projector at the top projecting a beam downwards. Under 'Vertical installation', 'Front Down (Projects downward)' shows the projector on a stand projecting a beam downwards, and 'Front Up (Projects upward)' shows the projector on a stand projecting a beam upwards.</p> </div> <div style="text-align: center;"> <p>The diagrams illustrate two portrait installation attitudes. 'Portrait 1*7 (The buttons of the unit face up)' shows the projector on a stand with its buttons facing up. 'Portrait 2*7 (The buttons of the unit face down)' shows the projector on a stand with its buttons facing down.</p> </div>
High Altitude Mode ^{*8}	<p>On/Off: Set to “On” when using the projector at an altitude of 1,500 m or higher. Continuing to use the wrong setting may affect component reliability.</p>
Screen Aspect	<p>16:10/16:9/4:3: For switching the display area to suit to the screen.</p>
Panel Alignment ^{*9}	<p>This feature allows you to adjust the gaps in the color of characters or the picture. When set to “On,” “Adjust Color” and “Pattern Color” can be assigned and adjusted. Adjust Item: Selects how to make adjustments from below. Shift: Shifts the whole picture and makes adjustments. Zone: Selects the desired range and makes adjustments. Adjust Color: Assigns the desired color to adjust the gaps in color. Select “R” (Red) or “B” (Blue) to make adjustments based on “G” (Green). Pattern Color: Select “R/G” (Red and Green) or “R/G/B” (White, all colors) when “Adjust Color” is “R” (Red). Select “B/G” (Blue and Green) or “R/G/B” (White, all colors) when the “Adjust Color” is “B” (Blue). Adjust: The shift adjustment and zone adjustment of the color selected in “Adjust Color” can be made with $\blacktriangle/\blacktriangledown/\blacktriangleleft/\blacktriangleright$ keys. Reset: The panel alignment settings are initialized to their factory preset values.</p>

Setting items	Description
Color Matching ^{*10}	Adjust/Reset: For correcting the brightness and color of the whole projected image manually from the signal level in six steps.

Notes

- *1: You cannot adjust anything other than the targeted adjustment zones in “Zone Black Level Adj.”
- *2: When selecting the correction zone of “Zone Black Level Adj.,” the targeted correction zone flashes twice.
- *3: When “Edge Blending” is set to “On,” “Screen Fitting” (HV Keystone/Warping) is not displayed.
- *4: Depending on the position adjusted with the lens shift feature, the aspect ratio of the image may change from the original or projected image may be distorted with Keystone adjustment.
- *5: Since the HV Keystone/Warping adjustment is an electronic correction, the image may deteriorate.
- *6: Select “Link to Image Flip” only for horizontal installation. Be sure to select “Front Up” or “Front Down” for vertical installation, according to the installation direction of the projector. (Refer to the figures.)
- *7: In the case of a portrait installation, pay attention not to block the ventilation holes (exhaust/intake).
- *8: Do not use the projector at an altitude of 2,700 m or higher.
- *9: Depending on the adjustment value of “Panel Alignment,” the color and resolution may be changed.
- *10: The brightness and color of the projected image may not match completely, even after you adjust “Brightness” and “Color.”
- *11: If the Screen Aspect is set to 16:10 and input signal is 16:10 or 16:9, the image will be projected at the correct aspect. This function is not available when displaying two pictures.

i The Information Menu

The Information menu enables you to confirm various information on the projector, such as the total usage hours of a light.

Items	Description
Model Name	Displays the model name.
Serial No.	Displays the serial number.
fH / fV (horizontal frequency/vertical frequency)*1	Displays the horizontal frequency/vertical frequency/signal type of the current input signal.
Light Timer	Indicates the total usage time of a light.

Note

*1: These items may not be displayed depending on the input signal.

Using Network Features

Connection to the network allows you to operate the following features:

- Checking the current status of the projector via a Web browser.
- Remotely controlling the projector via a Web browser.
- Receiving the e-mail report for the projector.
- Making the network settings for the projector.
- Supports network monitoring and control protocol (Advertisement, PJ Talk, PJ Link, SNMP, AMX DDDP [Dynamic Device Discovery Protocol], Crestron RoomView).

Notes

- The menu displays used for the explanation below may be different depending on the model you are using.
- Supported Web browsers are Internet Explorer 8/9/10.
- The menu displays only English.
- If the browser of your computer is set to [Use a proxy server] when you have access to the projector from your computer, click the check mark to set accessing without using a proxy server.
- SNMP, AMX DDDP, and Crestron RoomView do not support IPv6.

Displaying the Control Window of the Projector with a Web Browser

- 1 Connect the LAN cable.

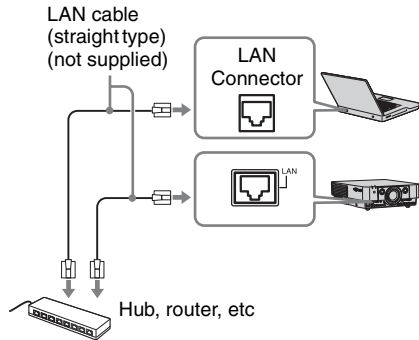

- 2 Set the network settings for the projector using “Network Setting” on the Connection/Power menu (page 26).

- 3 Start a web browser on the computer, enter the following in the address field, then press the Enter key on your computer.

`http://xxx.xxx.xxx.xxx`

(xxx.xxx.xxx.xxx: IP address for the projector)

When connecting with IPv6 addresses

`http://[xxxx:xxxx:••• xxxx]`

You can confirm the IP address of the projector under “Network Setting” on the Connection/Power menu (page 26).

The following window appears in the Web browser:

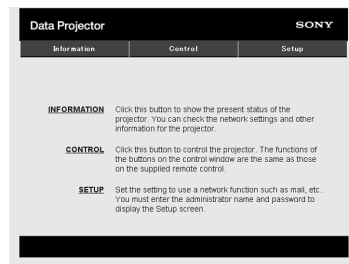

Once you make the network settings, you can open the Control window only by performing step 3 of this procedure.

How to operate the Control window

Switching the page

Click one of the Page Switching buttons to display the desired setting page.

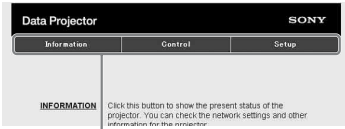

Page Switching buttons

Setting the access limitation

You can limit a user for accessing any particular page.

Administrator: Allowed access to all pages

User: Allowed access to all pages except the Setup page

Set under [Password] of the Setup page.

When you access the Setup page for the first time, enter “root” for user name and enter nothing for password.

The name of the administrator is preset to “root.”



Entry area for [Administrator]

Entry area for [User]

When you change the password, input a new password after deleting the password (*****) that was set.

Note

If you forget your password, consult with qualified Sony personnel.

Confirming the Information regarding the Projector

You can confirm the current settings for the projector on the Information page.



Information area

Operating the Projector from a Computer

You can control the projector from the computer on the Control page.

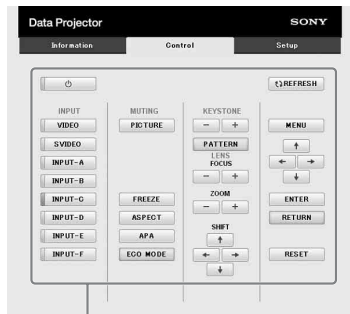

Operation area

The functions of the buttons shown in the operation area are the same as those of the keys on the supplied Remote Commander.

Using the e-mail report Function

Set the e-mail report function on the Setup page.

Entered values will not be applied unless you click on [Apply].

- 1 Click on [Owner information] to enter the owner information recorded in the e-mail report.

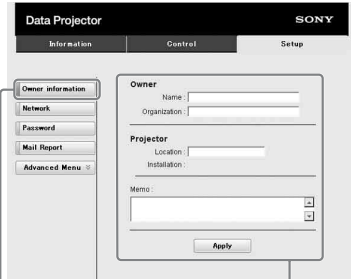

Owner information button

- 2 Set the timing of the e-mail report. Click on [Mail Report] to open the Mail Report page.
Maintenance Reminder: Set the timing for maintenance. To reset Maintenance Reminder, check the RESET check box and then click on [Apply].

Mail Report button

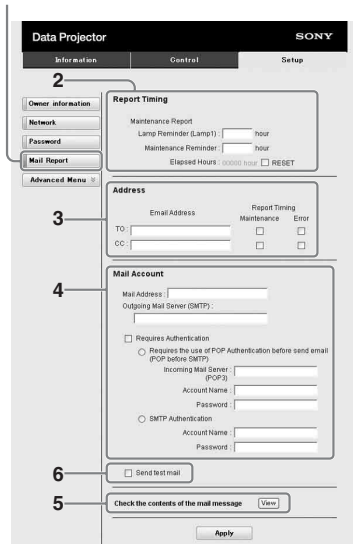

- 3 Enter the outgoing e-mail address in the Email Address box then check the Report Timing check box of the e-mail report to be sent.

- 4 Set the mail account for sending e-mail reports.

Mail Address: Enter the e-mail address.
Outgoing Mail Server (SMTP): Enter the address of outgoing mail server (SMTP).

Required Authentication: Check this check box if authentication is required for sending e-mail.

Requires the use of POP

Authentication before send email

(POP before SMTP): Check this check box to arrange for POP authentication to be performed before sending e-mail.

Incoming Mail Server (POP3): Enter the address of the incoming-mail server (POP3) to be used for POP3 authentication.

Account Name: Enter the mail account.

Password: Enter the password.

SMTP Authentication: Check this check box to arrange for SMTP authentication to be performed before sending e-mail.

Account Name: Enter the mail account.

Password: Enter the password.

- 5 Confirm the contents of the e-mail report.

When you click on [View] is pressed, the contents of the e-mail report are displayed.

- 6 Send the test mail.

Check on the Send test mail check box then click on [Apply] to send your test mail to the e-mail address you set.

Notes

- The e-mail report function is not available because the network which Outbound Port25 Blocking is used cannot be connected to the SMTP server.
- You cannot use the following characters to enter the characters in the text box: ‘ ’, “ ”, “ \ ”, “ & ”, “ < ”, “ > ”

Indicators

The indicators allow checking the status and notify you of abnormal operation of the projector. If the projector exhibits abnormal status, address the problem in accordance with the table below.

ON/STANDBY indicator

Status	Meaning/Remedies
Lights in red	The projector is in standby mode.
Flashes in green	<ul style="list-style-type: none"> • The projector is ready to operate after having been turned on. • The light source cools after the projector is turned off.
Lights in green	The projector's power is on.
Lights in orange	The projector is in With No Input (Light Cutoff), or Quick Reboot standby mode.
Flashes in red	The projector is in abnormal status. Symptoms are indicated by number of flashes. Address the problem in accordance with the following. If the symptom is shown again, consult with qualified Sony personnel.
Flashes twice	<p>The internal temperature is unusually high. Check the items below.</p> <ul style="list-style-type: none"> • Check to see if nothing is blocking the ventilation holes. • Check to see if the air filter is not clogged. • Check if "Installation Attitude" on the Installation menu is correctly selected.
Flashes six times	Unplug the AC power cord from a wall outlet. After checking that the ON/STANDBY indicator goes out, plug the power cord to a wall outlet again then turn on the projector.
Other number of flashes	Consult with qualified Sony personnel.

WARNING indicator

Status	Meaning/Remedies
Flashes in red	Symptoms are indicated by number of flashes. Address the problem in accordance with the following.
Flashes twice	The air filter cover or air filter unit are not attached securely.
Flashes three times	The temperature of the light source is unusually high. Turn off the power and consult with qualified Sony personnel.
Flashes eight times	<p>Drop impact has been detected.</p> <p>If you detect an abnormal condition, consult with qualified Sony personnel. If no abnormality is detected, unplug the AC power cord from a wall outlet. After checking that the ON/STANDBY indicator goes out, plug the power cord to a wall outlet again then turn on the projector.</p>

Messages List

When any of the messages listed below appears on the projected image, address the problem in accordance with the table below.

Message	Meaning/Remedy	Page
Clean the filter. Projector temperature is high. The light will turn off in 1 minute.	Check the items below. <ul style="list-style-type: none"> • Check to see if nothing is blocking the ventilation holes. • Check to see if the air filter is not clogged. • Check if “Installation Attitude” on the Installation menu is correctly selected. 	3, 29, 39
Frequency is out of range!	Change the output setting of the connected equipment to one for signals supported by the projector.	44
Please check Input-A Signal Sel.	Set “Input-A Signal Sel.” to “Auto” or select the input signal type to suit to the input signal.	26
Clean the filter. Projector temperature is high. Switching to High Altitude Mode.	At an altitude of 1,500 m or higher, if you are not using the projector, check the items below. <ul style="list-style-type: none"> • Check that nothing is blocking the ventilation holes. • Check that the air filter is not clogged. • Check if “Installation Attitude” on the Installation menu is correctly selected. 	3, 29, 39
Not applicable!	Invalid key pressed.	5
The panel keys are locked!	“Panel Key Lock” is set to “On.”	25
Function is locked!	The function is locked by external control.	5, 13, 14, 16, 28, 28
Projector will shutdown soon. Press I/⏻ Key to Restart.	The I/⏻ key was pressed and the projector will be shut down soon. To cancel shutdown, press the I/⏻ key again (the projector will remain on). To turn off the projector directly, press and hold the I/⏻ key.	17
Light Dimming	Reduces light output when “With Static Signal” is set. When any change in signal is detected, or an operation (remote control or control panel) is performed, normal brightness is restored.	27
Constant Brightness cannot be maintained.	Although “Constant Brightness” is selected, the brightness that is set cannot be maintained. It is necessary to change the light source unit to return to the original brightness. Consult with qualified Sony personnel.	26

Troubleshooting

Before asking to have the projector repaired, try to diagnose the problem, following the instructions below.

Symptom	Remedy	Page
The power is not turned on.	Check if the AC power cord is firmly connected.	–
	When the “Panel Key Lock” is set to “On,” you cannot turn on the projector using the I/⏻ key on the projector.	25
	If the air filter cover or air filter unit is not attached securely, the projector cannot be turned on.	39
No image.	Check if the connecting cable is connected to external equipment properly.	8
	Check if the computer signal is set for output to an external monitor. If you set your computer, such as a notebook computer, to output the signal to both your computer’s display and an external monitor, the picture of the external monitor may not appear properly. Set your computer to output the signal to only an external monitor.	12
	Check if the input source is correctly selected.	12
	Check if the picture is muted.	6
	During “Zone Black Level Adj.” adjustment, a black image is automatically projected.	16
On-screen display does not appear.	The on-screen display does not appear when “Status” in the Operation menu is set to “Off.”	25
The aspect ratio of the display is not right/the image is displayed smaller /a portion of image does not appear.	The image may not be displayed correctly with an input signal the projector cannot interpret correctly. In such a case, set “Aspect” manually.	21, 23
	Check if “Screen Aspect” is correctly selected.	29
The image is a trapezoid.	The images become trapezoidal because of the projection angle. In such a case, you can correct the trapezoidal distortion, using a Keystone feature.	5, 13, 28
The image is distorted.	Warping is set. Disable the warp correction feature.	14, 28
The image is dark/too bright.	The settings for “Brightness,” “Contrast,” and “Light Output Mode” affect brightness of the image. Check if the value is appropriate.	19, 26
	The image will be dark when the light source is burnt out. Check “Light Timer,” and consult with qualified Sony personnel.	31
	“With Static Signal” is set to “On.”	27
	When video signal is not input, the light is dimmed to reduce power consumption.	26
	When the temperature around the unit is high, the brightness will be reduced to protect the unit.	–

Symptom	Remedy	Page
The image is not clear.	Check if the projector is in focus.	13
	The picture will not be clear if condensation has accumulated on the lens. In such a case, let the projector sit for about two hours with the power on.	–
The image is noisy.	Check if the connecting cable is connected to external equipment properly.	8
No sound.	Check that the connecting cables between the projector and external video or audio equipment are securely connected.	8
	Check if the output setting of connected external audio equipment is set for output the audio signal from the projector.	–
	Audio is not output if audio muting is activated.	6
	Check if the “Audio Output Vol.” is set to minimum.	6
The Remote Commander does not work.	Check that the batteries are installed correctly.	–
	Check that the batteries are not exhausted.	–
	Check if the “ID Mode” of the projector corresponds to that of the Remote Commander.	7, 25
	Check the setting for “IR Receiver.”	25
The fan is noisy.	The sound from the fan is often greater than normal to cool the light source in the following cases. <ul style="list-style-type: none"> • When “Light Output Mode” is set to “High.” • The projector is in at high altitude (“High Altitude Mode” is set to “On”) • Temperature is very high. • Air filter is blocked. 	26, 29, 39
	If the ventilation holes are blocked, the internal temperature of the projector rises and the fan noise becomes larger.	3
Cannot adjust the keystone setting.	Disable the Edge Blending setting.	13, 28
	Select “HV Keystone” in “Screen Fitting.”	13, 28
Cannot adjust the Warp setting.	Disable the Edge Blending setting.	14, 28
	Select “Warping” in “Screen Fitting.”	14, 28

Cleaning the Air Filter

When a message appears on the projected image indicating time for a filter cleaning, clean the air filter (pages 35, 36). If the dust cannot be removed from the air filter even after cleaning, replace the air filter with a new one. For details on a new air filter, consult with qualified Sony personnel.

Caution

If you neglect to clean the air filter, dust may accumulate, clogging it. As a result, the temperature may rise inside the unit, leading to a possible malfunction or fire.

- 1 Turn off the projector, and disconnect the AC power cord from the AC outlet.
- 2 Open the air filter cover by loosening the screw on the air filter cover.

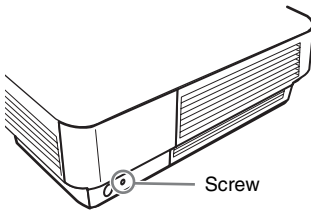

- 3 Pull out the air filter unit.

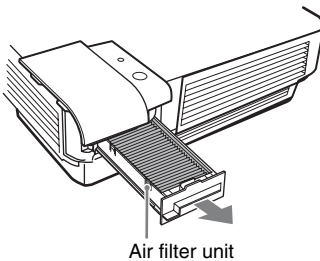

- 4 Clean the air filter with a vacuum cleaner. Remove the air filter as illustrated below, then clean the two air filters.

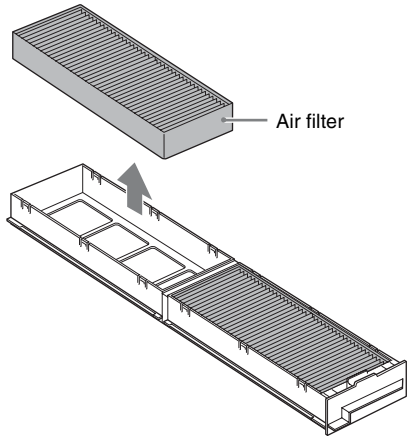

- 5 Return the air filter to the air filter unit then return it to the projector.
- 6 Close the air filter cover and tighten the screw.

Notes

- Be sure to attach the air filter unit and air filter cover firmly; the power cannot be turned on if it is not closed securely.
- Do not loosen screws other than that on the air filter cover.

Specifications

Item	Description	
Model name	VPL-FHZ55	
Display system	3 LCD system	
Display device	Size of effective display area	0.76" (19.3 mm) × 3, Aspect ratio 16:10
	Number of pixels	6,912,000 (1920 × 1200 × 3) pixels
Projection lens	Zoom	Manual (approx.1.6 ×)
	Focus	Manual
Light source	Laser diode	
Screen size	40" to 600" (1.02 m to 15.24 m)	
Light output	4,000 lm	
Displayable scanning frequency* ¹	Horizontal: 14 kHz to 93 kHz, Vertical: 47 Hz to 93 Hz	
Display resolution	Computer signal input	Maximum display resolution: 1920 × 1200 dots Panel display resolution: 1920 × 1200 dots
	Video signal input	NTSC, PAL, SECAM, 480/60i, 576/50i, 480/60p, 576/50p, 720/60p, 720/50p, 1080/60i, 1080/50i, 1080/60p, 1080/50p, 1080/24p
Color system	NTSC ^{3.58} , PAL, SECAM, NTSC ^{4.43} , PAL-M, PAL-N, PAL60	
Computer and video signal input/output	INPUT A	RGB/YPbPr input connector: 5BNC female, G with sync/Y: 1 V _{p-p} ± 2 dB, sync negative, 75 ohms terminated, RGB/PbPr: 0.7 V _{p-p} ± 2 dB, 75 ohms terminated, Sync signal: TTL level high impedance, positive/negative Audio input connector: Stereo mini jack, rated input 500 mVrms, input impedance more than 47 kilohms
	INPUT B	RGB input connector: Mini D-sub 15-pin female, RGB: 0.7 V _{p-p} ± 2 dB, 75 ohms terminated, Sync signal: TTL level high impedance, positive/negative Audio input connector: Stereo mini jack, rated input 500 mVrms, input impedance more than 47 kilohms
	INPUT C	DVI-D input connector: DVI-D 24-pin (Single link), DVI 1.0 compliant, HDCP support Audio Input connector: Shared with INPUT B
	INPUT D* ¹	HDMI input connector: Digital RGB/YPbPr, Digital audio: PCM (32 kHz, 44.1 kHz, 48 kHz, 88.2 kHz, 96 kHz)

Item	Description	
Model name	VPL-FHZ55	
S VIDEO IN		<p>S video input connector: Mini DIN 4-pin, Y: 1 Vp-p \pm 2 dB, sync negative, 75 ohms terminated, C: (burst signal) 0.286 (NTSC)/0.3 (PAL/SECAM) Vp-p \pm 2 dB, 75 ohms terminated</p> <p>Audio input connector: Phono jack \times 2, rated input 500 mVrms, Input impedance more than 47 kilohms</p>
VIDEO IN		<p>Video input connector: Phono jack, 1 Vp-p \pm 2 dB, sync negative, 75 ohms terminated</p> <p>Audio input connector: Shared with S VIDEO IN</p>
OUTPUT		<p>MONITOR output connector: Mini D-sub 15-pin female, G with sync/Y: 1 Vp-p \pm 2 dB, sync negative, 75 ohms terminated, RGB/PbPr: 0.7 Vp-p \pm 2 dB, 75 ohms terminated, Sync signal: HD, VD 4 V (open), 1 Vp-p (75 ohms), positive/negative</p> <p>Audio output connector: Stereo mini jack, stereo, 1 Vrms (maximum volume, when inputting 500 mVrms), output impedance 5 kilohms</p>
Control signal input/output		<p>RS-232C connector: D-Sub 9 pin female</p> <p>LAN connector: RJ45, 10BASE-T/100BASE-TX</p> <p>CONTROL S input connector (DC power supply): Stereo mini jack, 5 Vp-p, Plug in power DC 5 V</p>
Operating temperature/ Operating humidity		0 °C to 40 °C (32 °F to 104 °F)/20% to 80% (no condensation)
Storage temperature/ Storage humidity		-10 °C to +60 °C (14 °F to +140 °F)/ 20% to 80% (no condensation)
Power requirements		100 V to 240 V AC, 4.5 A to 2.0 A, 50/60 Hz
Power consumption	AC 100 V to 120 V	449 W
	AC 220 V to 240 V	426 W
Standby power requirements	AC 100 V to 120 V	8.5 W (when "Standby Mode" is set to "Standard") / 0.15 W (when "Standby Mode" is set to "Low")
	AC 220 V to 240 V	9.5 W (when "Standby Mode" is set to "Standard") / 0.3 W (when "Standby Mode" is set to "Low")
Heat dissipation	AC 100 V to 120 V	1,528 BTU
	AC 220 V to 240 V	1,450 BTU

Item	Description
Model name	VPL-FHZ55
Outside dimensions	390 × 148 × 500 mm (15 11/32" × 5 13/16" × 19 11/16") (W/H/D) (including the lens cap for packaging) 390 × 134 × 487 mm (15 11/32" × 5 9/32" × 19 3/16") (W/H/D) (without protrusions)
Mass	Approx. 11 kg (25 lb)
Supplied accessories	See "Checking the Supplied Accessories" in the supplied Quick Reference Manual.
Optional accessories *2 *3	Projector Suspension Support PSS-610

Notes

The values for mass and dimensions are approximate.

*1: For details, refer to "Acceptable Input Signals" on page 44.

*2: Not all optional accessories are available in all countries and area. Please check with your local Sony Authorized Dealer.

*3: Information on accessories in this manual is current as of Aug. 2013.

Design and specifications of the unit, including the optional accessories, are subject to change without notice.

Pin assignment

DVI-D connector (DVI-D, female)

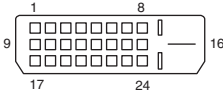

1	T.M.D.S. Data2-	14	+5 V Power
2	T.M.D.S. Data2+	15	Ground (return for +5 V)
3	T.M.D.S. Data2 Shield	16	Hot Plug Detect
4	NC	17	T.M.D.S Data0-
5	NC	18	T.M.D.S Data0+
6	DDC Clock	19	T.M.D.S Data0 Shield
7	DDC Data	20	NC
8	NC	21	NC
9	T.M.D.S. Data1-	22	T.M.D.S Clock Shield
10	T.M.D.S. Data1+	23	T.M.D.S Clock+
11	T.M.D.S. Data1 Shield	24	T.M.D.S Clock-
12	NC		
13	NC		

RGB input connector (Mini D-sub 15-pin, female)

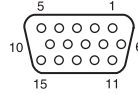

1	Video input (red) R	9	Power supply input for DDC
2	Video input (green) G	10	GND
3	Video input (blue) B	11	GND
4	GND	12	DDC/SDA
5	RESERVE	13	Horizontal sync signal
6	GND (R)	14	Vertical sync signal
7	GND (G)	15	DDC/SCL
8	GND (B)		

RS-232C connector (D-Sub 9-pin, female)

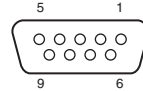

1	NC	6	NC
2	RXDA	7	RTS
3	TXDA	8	CTS
4	DTR	9	NC
5	GND		

Others

HDMI connector (HDMI, female)

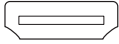

1	T.M.D.S. Data2+	11	T.M.D.S. Clock Shield
2	T.M.D.S. Data2 Shield	12	T.M.D.S. Clock-
3	T.M.D.S. Data2-	13	NC
4	T.M.D.S. Data1+	14	RESERVED (N.C.)
5	T.M.D.S. Data1 Shield	15	SCL
6	T.M.D.S. Data1-	16	SDA
7	T.M.D.S. Data0+	17	GND
8	T.M.D.S. Data0 Shield	18	+5V Power
9	T.M.D.S. Data0-	19	Hot Plug Detect
10	T.M.D.S. Clock+		

Acceptable Input Signals

Computer signal

Resolution	fH [kHz]/ fV [Hz]	Input connector	
		RGB *1	DVI-D *2/ HDMI *3
640 × 350	31.5/70	●	–
	37.9/85	●	–
640 × 400	31.5/70	●	–
	37.9/85	●	–
640 × 480	31.5/60	●	●
	35.0/67	●	–
	37.9/73	●	–
	37.5/75	●	–
	43.3/85	●	–

Resolution	fH [kHz]/ fV [Hz]	Input connector	
		RGB *1	DVI-D *2/ HDMI *3
800 × 600	35.2/56	●	–
	37.9/60	●	●
	48.1/72	●	–
	46.9/75	●	–
832 × 624	53.7/85	●	–
	49.7/75	●	–
1024 × 768	48.4/60	●	●
	56.5/70	●	–
	60.0/75	●	–
1152 × 864	68.7/85	●	–
	64.0/70	●	–
	67.5/75	●	–
1152 × 900	77.5/85	●	–
	61.8/66	●	–
1280 × 960	60.0/60	●	●
	75.0/75	●	–
1280 × 1024	64.0/60	●	●
	80.0/75	●	–
	91.1/85	●	–
1400 × 1050	65.3/60	●	●
1600 × 1200	75.0/60	●	●
1280 × 768	47.8/60	●	●
1280 × 720	45.0/60	●	●*6
1920 × 1080	67.5/60	–	●*6
1366 × 768	47.7/60	●	●
1440 × 900	55.9/60	●	●
1680 × 1050	65.3/60	●	●
1280 × 800	49.7/60	●	●
1920 × 1200	74.0/60	●*5	●*5
1600 × 900	60.0/60	●*5	●*5

Digital TV signal

Signal	fV [Hz]	Input connector	
		RGB/ YPbPr ^{*4}	DVI-D ^{*2} / HDMI ^{*3}
480i	60	●	●
576i	50	●	●
480p	60	●	●
576p	50	●	●
1080i	60	●	●
1080i	50	●	●
720p	60	●	● ^{*6}
720p	50	●	●
1080p	60	–	● ^{*6}
1080p	50	–	●
1080p	24	–	●

Analog TV signal

Signal	fV [Hz]	Input connector
		VIDEO/ S VIDEO
NTSC	60	●
PAL/SECAM	50	●

Notes

- *1: INPUT A, INPUT B
- *2: INPUT C
- *3: INPUT D
- *4: INPUT A
- *5: Available for VESA Reduced Blanking signals only.
- *6: INPUT C is determined as a computer signal; INPUT D is determined as a digital TV signal.
- When a signal other than the signals listed in table is input, the picture may not be displayed properly.
- An input signal meant for screen resolution different from that of the panel will not be displayed in its original resolution. Text and lines may be uneven.
- Some actual value may differ slightly from the design values given in the table.

Combinations of Input Signals

Main picture	Sub picture
INPUT A (RGB/YPbPr)	INPUT B (RGB)
INPUT B (RGB)	–
INPUT C (DVI-D)	INPUT B (RGB)
INPUT D (HDMI)	
S VIDEO	
VIDEO	

Projection Distance and Lens Shift Range

The projection distance refers to the distance between the front of the lens and the projected surface.

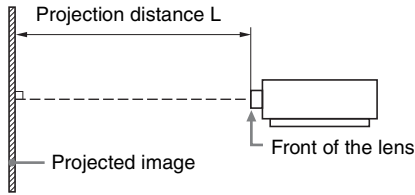

The lens shift range represents the distance in percent (%) by which the lens can be shifted from the center of the projected image. The lens shift range is regarded as 0% when the point (A) in the illustration (point where a line drawn from the center of the lens and the projected image cross at right angles) is aligned with the center of the projected image and full width or full height of the projected image is regarded as 100%.

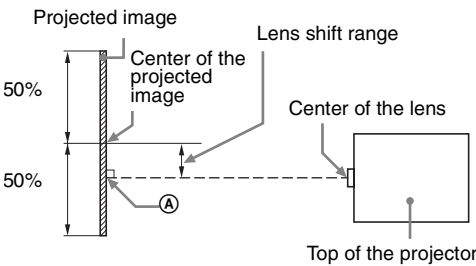
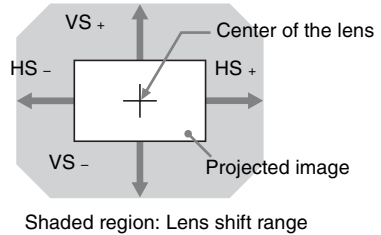
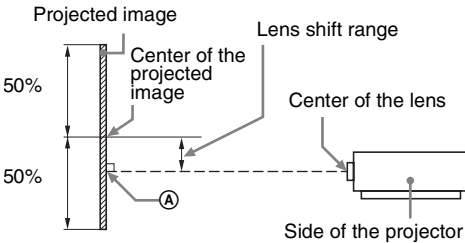

- VS +: Vertical lens shift range (up) [%]
- VS -: Vertical lens shift range (down) [%]
- HS +: Horizontal lens shift range (right) [%]
- HS -: Horizontal lens shift range (left) [%]

Projection distance

Unit: m (inches)

Projection image size		Projection distance L
Diagonal	Width × Height	Standard lens
80" (2.03 m)	1.72 × 1.08 (68 × 42)	2.39 – 3.83 (95 – 150)
100" (2.54 m)	2.15 × 1.35 (85 × 53)	3.00 – 4.80 (119 – 189)
120" (3.05 m)	2.58 × 1.62 (102 × 64)	3.61 – 5.77 (143 – 227)
150" (3.81 m)	3.23 × 2.02 (127 × 79)	4.53 – 7.22 (179 – 284)
200" (5.08 m)	4.31 × 2.69 (170 × 106)	6.05 – 9.64 (238 – 379)

Projection distance formula

D: Projected image size (Diagonal)

Unit: m (inches)

Lens	Projection distance L (minimal length)	Projection distance L (maximal length)
Standard lens	$L=0.030453 \times D - 0.0465$ ($L=1.198941 \times D - 1.8307$)	$L=0.048463 \times D - 0.0443$ ($L=1.907978 \times D - 1.7435$)

Note

Do not use any lens other than the standard lens.

Lens shift range

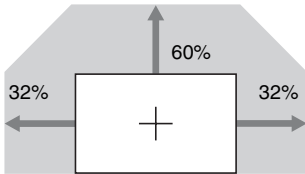

$$VS + = 60 - 1.875 \times HS \text{ (HS + or HS -) [\%]}$$

$$VS - = 0 \text{ [\%]}$$

$$HS + = HS - = 32 - 0.533 \times VS + \text{ [\%]}$$

About lens position

The projection distance and lens position are measured with the lens position adjusted to the center. To adjust the lens position to the center, follow the procedures below:

- 1 Rotate the left lens shift dial clockwise or counterclockwise then align the lens fixing screws with the \blacktriangle \blacktriangledown marks in four places, as illustrated, for adjusting the lens horizontally.
- 2 Rotate the right lens shift dial clockwise until the lens is fixed, to adjust the lens vertically.

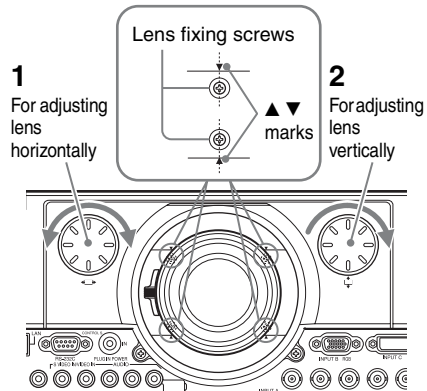

Note

Before adjusting the lens position to the center and checking whether the lens position is centered, turn off the power to prevent projected light from entering the eyes.

Others

Dimensions

Front

Unit: mm (inches)

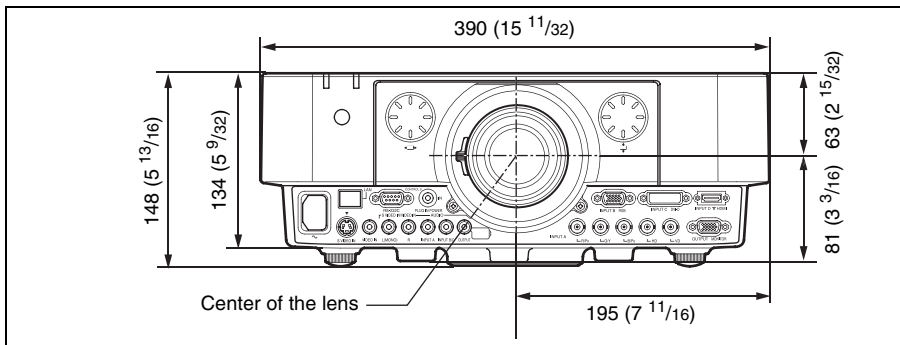

Bottom

Unit: mm (inches)

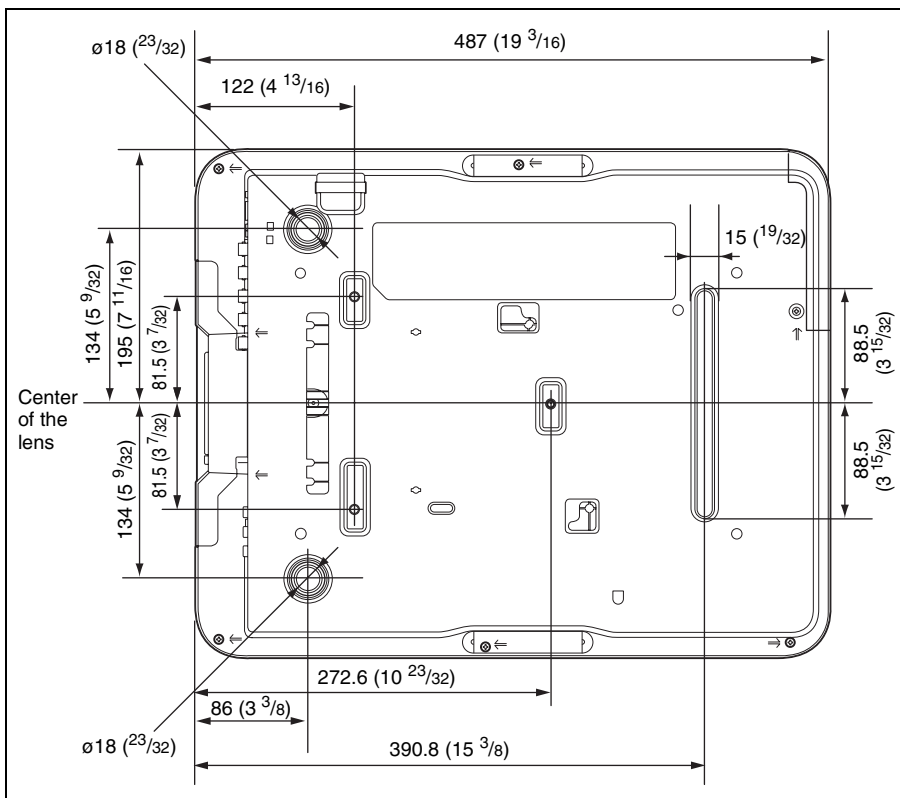

Location information of the labels

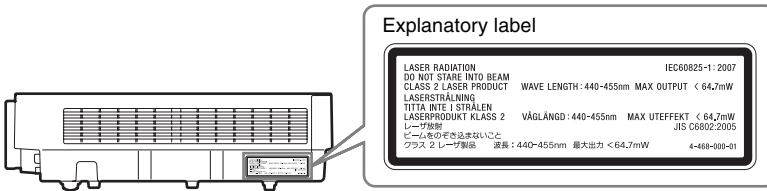
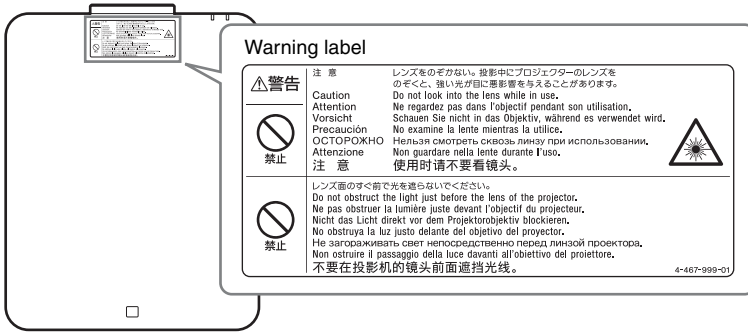

Light source specifications

1.6 W laser diodes × 56

Wavelength: 440 - 455 nm

Beam divergence angle from lens of this unit

Wide: $\alpha = 45.3^\circ$

Tele: $\alpha = 29.4^\circ$

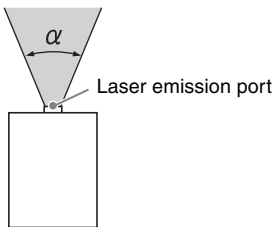

When using the PSS-610 projector suspension support

Unit: mm (inches)

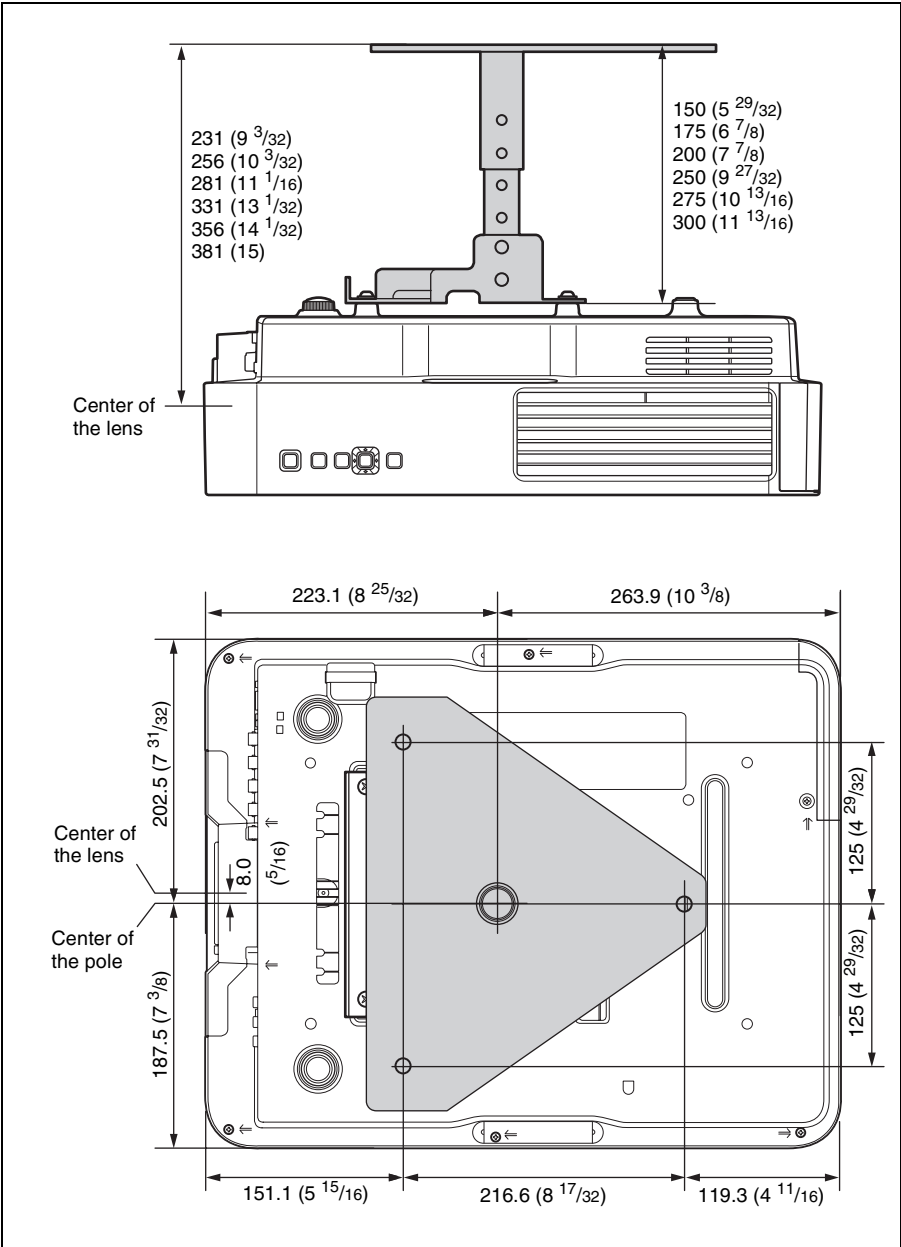

The distance L' between the front of the lens (center) and the front of the cabinet

Unit: mm (inches)

Lens	L'
Standard lens	12.2 ($1^5/32$)

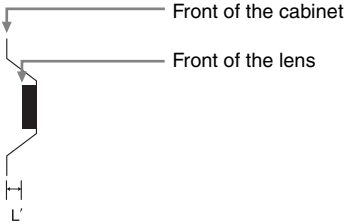

About Trademarks

- Adobe Acrobat is a trademark of Adobe Systems Incorporated.
- Kensington is a registered trademark of Kensington Technology Group.
- Internet Explore is registered trademarks of Microsoft Corporation in the United States and/or other countries.
- PJLink is a registered trademark of Japan Business Machine and Information System Industries Association.
- AMX is a trademark of AMX Corporation.
- The terms HDMI and HDMI High-Definition Multimedia Interface, and the HDMI Logo are trademarks or registered trademarks of HDMI Licensing LLC in the United States and other countries.
- Crestron RoomView is a trademark of Crestron Corporation.
- All other trademarks and registered trademarks are trademarks or registered trademarks of their respective holders. In this manual, [™] and [®] marks are not specified.

Others

Index

A

AC IN socket	4
Acceptable input signal	44
Adjust Signal	21
Air filter cover	3
All Reset	24
Antitheft bar	3
Antitheft Lock	3
APA	5, 21
Aspect	5, 21, 23
Audio muting	6
Audio Output Vol.	24
Auto Power Saving	26

B

Background	24
Black Level Adj.	19
Blend Gamma	28
Blending function	16
Blending Range	28
Brightness	19

C

CC Display	24
Cleaning the air filter	39
Color	19
Color Matching	30
Color System	26
Color Temp.	19
Combinations of input signals	45
Connecting a computer	8
Connecting an external monitor and audio equipment	11
Connecting video equipment	9
Connection/Power menu	26
Connector panel	3, 4
Constant Brightness	26
Contrast	19
Control panel	5
CONTROL S input connector	4
CONTROL S output connector	7
Control window	32

D

Default Gateway	26
Digital Zoom	5
Dimensions	48

Direct Power On	27
-----------------------	----

E

ECO	26
ECO MODE (Energy-saving mode)	6
Edge Blending	28
E-mail report	33
Expert Setting	19

F

fH	31
Film Mode	19
Focus	13
Focus ring	3
Freeze	6
Front feet (adjustable)	3, 13
Front panel	3
Function menu	24
fV	31

G

Gamma Mode	19
------------------	----

H

H Keystone	28
High Altitude Mode	29
Hue	19

I

ID Mode	25
ID MODE 1/2/3 switch	7
Image Flip	28
Image Split	28
Information menu	31
Input	4
Input-A Signal Sel.	26
Installation Attitude	29
Installation menu	28
IP Address	26
IP Address Setup	26
IR Receiver	25

K

Keystone adjustment	13
---------------------------	----

L

LAN connector	4, 32
Language	25
Lens shift dial	3

Lens shift range	47
Light Output Mode	26
Light Timer	31
Location and function of controls	3

M

Main unit	3
Menu Position	25
Messages list	36
Model Name	31

N

Network Setting	26
-----------------------	----

O

ON/STANDBY indicator	3, 35
Operation menu	25
Output	4
Over Scan	21

P

Panel Alignment	29
Panel Key Lock	25
Pattern	5, 13
Phase	21
Picture menu	19
Picture mode	19
Picture muting	6
Pin assignment	43
Pitch	21
Primary DNS	26
Projecting an image	12
Projection distance	47
Projection distance and lens shift range ..	46
Projection distance formula	47

Q

Quick Reboot	27
--------------------	----

R

Remote commander	5
Remote control detector	3
Reset	19, 28
RS-232C connector	4

S

Screen Aspect	29
Screen Fitting	28
Screen menu	21

Secondary DNS	26
Security Lock	25
Selecting an input signal	5
Serial No.	31
Sharpness	19
Shift	13, 21
Smart APA	24
Specifications	40
Standby	5
Standby Mode	27
Start Up Image	24
Status	25
Subnet Mask	26

T

Troubleshooting	37
Turn off	17
Turn on	5, 12
Twin picture	6

U

Using a menu	18
Using network features	32

V

V Center	21
V Keystone	28
Ventilation holes	3
Vertical Size	21
Volume	6

W

WARNING indicator	3, 35
Warp correction	14
Warping	28
With No Input	26
With Static Signal	27

Z

Zone Black Level Adj.	28
Zoom	13
Zoom lever	3

