



## Handling Precautions

1. Before taking pictures of important events, such as weddings and trips, check to make sure the camera is working properly.
2. This camera is not resistant to water, and should not be used outdoors if it is raining or snowing. Keep the camera out of salt spray and excessive humidity. If used at the beach, clean it thoroughly afterward with a dry cloth.
3. Store the camera in a cool, dry, dust-free place. Be sure to keep the camera out of direct sunlight, and away from "hot spots" such as the trunk or rear window shelf of a car. Avoid places where mothballs are used, and use a desiccant in excessive humidity.
4. Do not attempt to disassemble the camera yourself, since there is high-voltage circuitry inside.
5. The battery may explode or cause burns if disassembled, recharged, shorted, exposed to high temperatures, or disposed of in a fire.
6. Use a blower brush to remove dust and sand from the lens and inside the camera. Do not apply any fluids to the lens or body.

### Convention



Warnings you should observe when using the camera.



Additional information on using the camera.

Please note that these instructions are for both the model with the date function and model without date function. Information relevant only to the model with the date function is marked with the **DATE** symbol.

## ■ Nomenclature

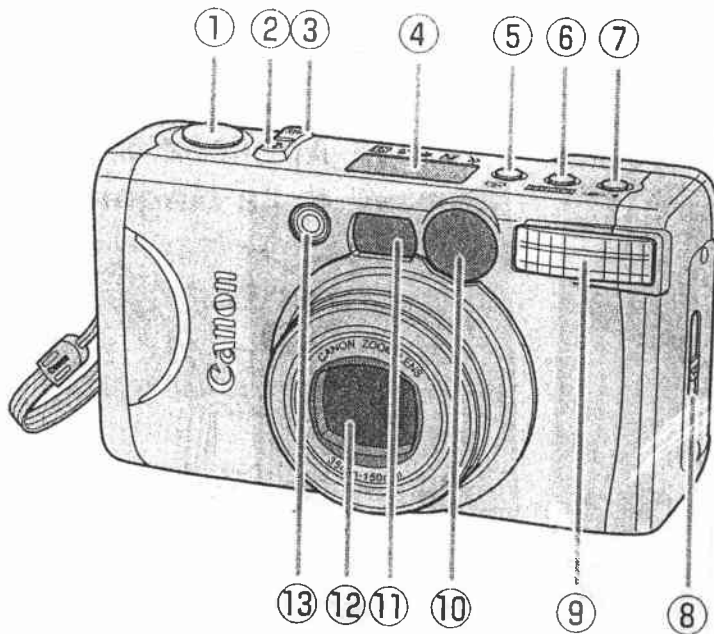

### Attaching the Strap

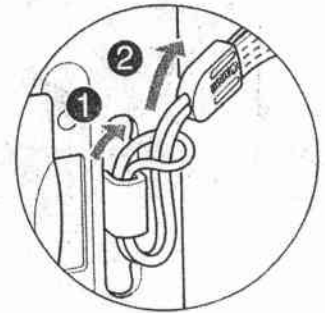

### Front

- ① **Shutter button**
- ② Zoom-in (telephoto)/  
Set **DATE** button
- ③ Zoom-out (wide-angle)/  
Selection **DATE** button
- ④ LCD panel
- ⑤ Self-timer button
- ⑥ **MODE** Mode button
- ⑦ Flash mode button
- ⑧ Back cover release lever
- ⑨ Flash
- ⑩ Viewfinder window
- ⑪ AF sensor/metering window  
Soiling on the AF sensor causes *FOCUSING* problems. Wipe off any dust or dirt before taking pictures.
- ⑫ Lens  
Soiling on the lens causes focusing problems. Wipe off any dust or dirt before taking pictures.
- ⑬ Red-eye reduction/Self-timer lamp/  
AF-assist beam emitter
- ⑭ **Main switch**  
Pressing the main switch turns the camera on and sets the lens to the wide-angle position. If you press it again, the lens retracts, the lens cover closes and the camera switches off. When you switch the camera off, the display on the LCD panel does not disappear.
- ⑮ Film check window
- ⑯ Strap
- ⑰ Strap mount
- ⑱ Battery compartment cover
- ⑲ Mid-roll rewind button  
Hold this button down until the film starts to rewind.
- ⑳ Tripod socket

## ■ Nomenclature

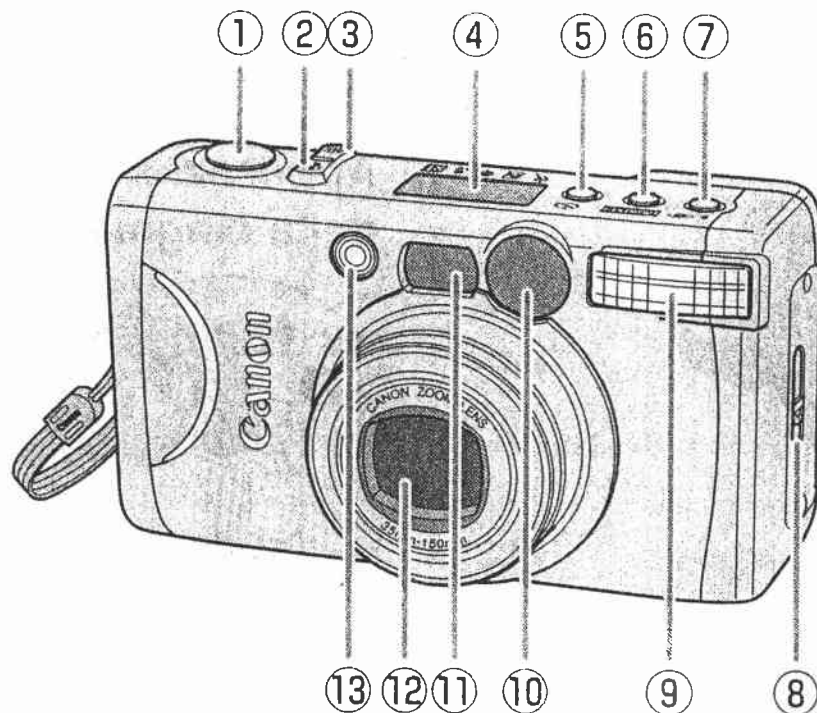

### Front

- ① **Shutter button**
- ② Zoom-in (telephoto)/  
Set **DATE** button
- ③ Zoom-out (wide-angle)/  
Selection **DATE** button
- ④ LCD panel
- ⑤ Self-timer button
- ⑥ **MODE** Mode button
- ⑦ Flash mode button
- ⑧ Back cover release lever
- ⑨ Flash
- ⑩ Viewfinder window
- ⑪ AF sensor/metering window  
Soiling on the AF sensor causes focusing problems. Wipe off any dust or dirt before taking pictures.
- ⑫ Lens  
Soiling on the lens causes focusing problems. Wipe off any dust or dirt before taking pictures.
- ⑬ Red-eye reduction/Self-timer lamp/  
AF-assist beam emitter

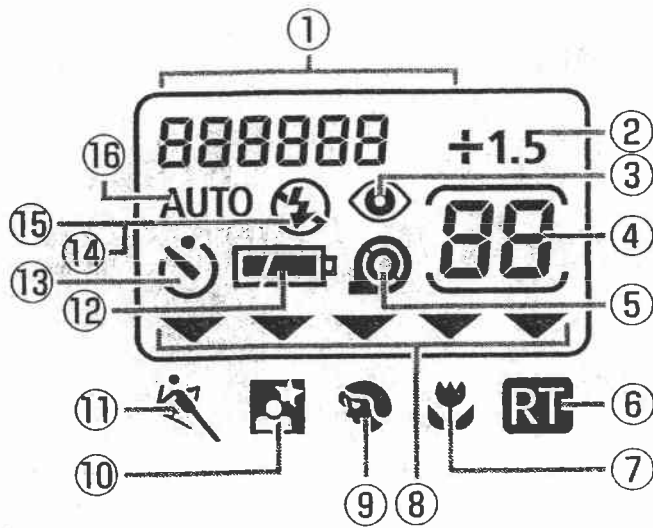

**DATE**

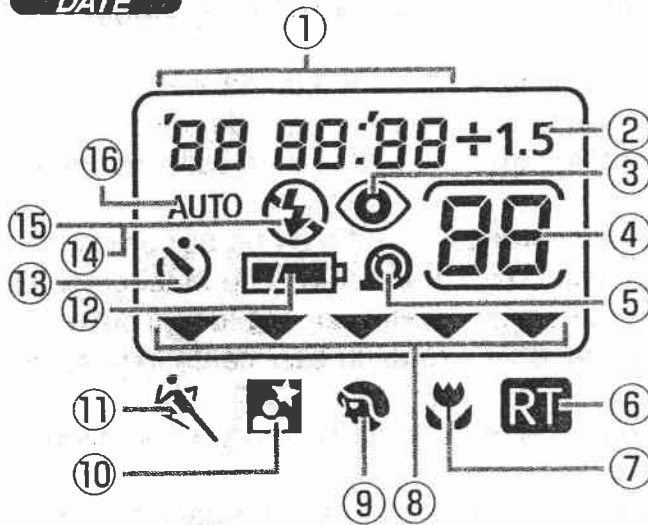

## LCD Panel

(Normally, only necessary information displayed)

- ① Date **DATE** / Custom Function number
- ② Manual exposure compensation
- ③ Red-eye reduction mark
- ④ Frame counter
- ⑤ Film mark
- ⑥ Real-time release
- ⑦ Close-up
- ⑧ Mode selection indicator
- ⑨ Portrait
- ⑩ Night portrait
- ⑪ Action
- ⑫ Battery level indicator
- ⑬ Self-timer
- ⑭ ⚡ Flash ON (Fires for all shots)
- ⑮ ⚡ Flash OFF (Never fires)
- ⑯ Autoflash

**!** When "H" is displayed, remove the battery from the camera, wait until "H" is no longer displayed and then reload the battery.

# Loading the Battery and Checking the Battery Level

## ■ Loading the Battery

Applicable Battery: One lithium battery (CR2)

### 1 Open the battery cover.

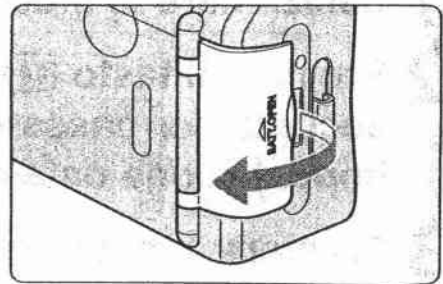

### 2 Load a new battery.

- Align the + – terminals correctly and insert the battery – end first.
- ➔ The  appears on the LCD panel.

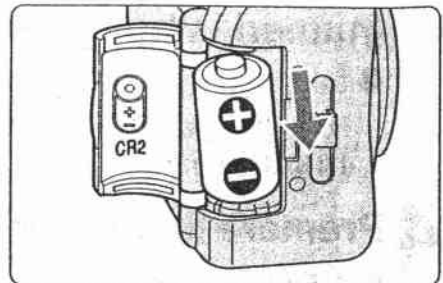

### 3 Close the battery cover.

- Push the cover closed until you hear a clicking sound.
- ➔ The date display “-- -- --” on the LCD panel blinks. Set the date and time.

**DATE**

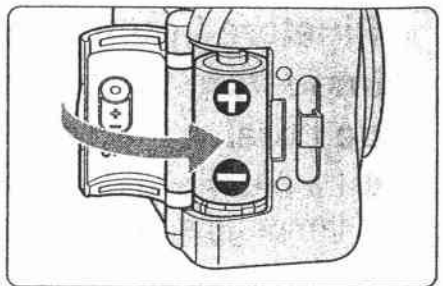

 The camera will not operate if the + – terminals are aligned incorrectly.

## ■ Checking the Battery Level

Check that  appears on the LCD panel when you turn the power on. Change the battery if  is displayed.

 (lit) The battery level OK.

 (lit) Prepare a new battery.

 (blinking) Load a new battery.

**A new battery will generally provide enough charge to shoot approx. 14 rolls of 24-exposure film** (based on Canon's Standard Test Method at normal temperature and with 50% flash use). At low temperatures (–10°C/ 14°F), the battery life is approximately one third of the normal figure.

 When you take consecutive shots using the flash, the battery level may drop off temporarily and prevent the LCD panel from displaying information correctly.

# Loading and Removing the Film

## ■ Loading the Film

**1** Open the back cover and load the film.

- Push the back cover release lever down.

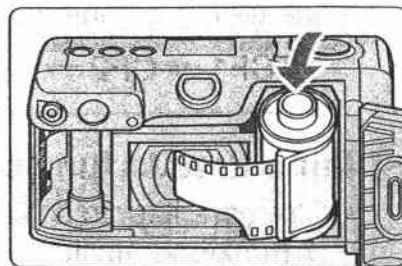

**2** Position the film correctly between the film guides.

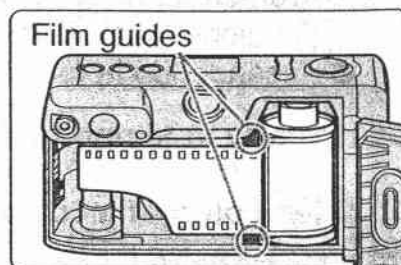

**3** Pull the film out to the  (film leader position indicator).

- Make sure that there is no slack in the film when you pull it out.
- If the edge of the film leader goes beyond the film leader position indicator, rewind some of the film back into the cartridge.

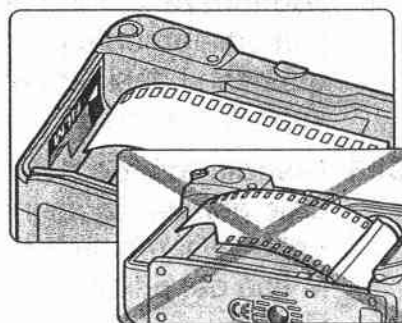

**4** Close the back cover.

- ➔ The film automatically winds on to the first frame and "1" appears on the frame counter.
- If the frame counter shows a blinking "0", the film did not load correctly. Load the film again.

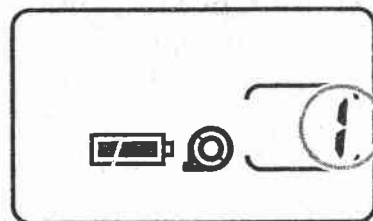

-  ISO 400 DX-coded film is recommended. The film speed is set to ISO 25 when non-DX film is loaded. If the film does not have a DX-code, insert it into the film compartment, close the back cover and press the shutter button once or twice.

## ■ Removing the Film

The film rewinds automatically when it reaches the end.

When the film is fully rewound, the frame counter shows "0" and the  blinks. Then open the back cover and remove the film.

- If the  is not blinking, press the  button.

- If you take more pictures than stipulated on the film, the last frame is cut during developing, and the date and time may not be imprinted on the last frame.

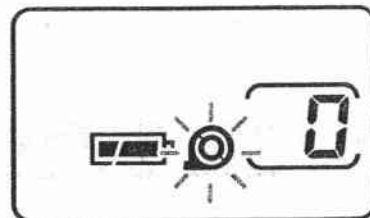

## Taking Pictures in Autoflash (Full-auto) Mode

As long as the subject is in the wide area AF frame, the subject will be in focus. The flash also fires automatically in low light or backlit conditions.

**1 Press the main switch to turn the camera on.**

**2 Decide on the size of your subject.**

- Pressing [▲] zooms in on your subject while pressing [▶▶▶] zooms out for a wide-angle shot.

**3 Set the focus.**

- Position the wide area AF frame over your subject and lightly press the shutter button halfway down.
- ➔ When the subject is in focus, the green lamp lights.
- Keep the shutter button pressed halfway.

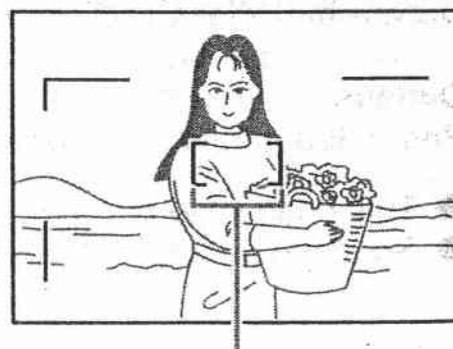

Wide area AF frame

**4 Compose the shot and take the picture.**

- Press the shutter button fully.
- Press the shutter button slowly and gently.



### ● Holding the Camera

Grasp the camera firmly with both hands so that it does not move, and make sure that your hair, fingers or camera strap etc. do not come into contact with the lens, the AF sensor/metering window or the flash.

### ● Shutter Button

The shutter button is a two-stage switch. Lightly press it halfway to automatically determine focus and exposure. Press it fully to take the picture.

- If the lens is left extended and is not used for 4 minutes, it is automatically retracted to wide-angle position.
- In dark places, the AF-assist beam emitter will light automatically.



### **Subjects Difficult to Autofocus**

The green lamp may blink 4 times per second for subjects with the following characteristics that cannot be brought into focus.

In situations like this, focus on something roughly the same distance away as your subject and lock the focus for the shot.

#### **Main types of subjects where focusing is difficult:**

- Subjects in scenes without much contrast, e.g. blue sky, or scenes of mainly one color
- Subjects in very dark places
- Subjects in extreme backlit situations or subjects which are extremely reflective, e.g. the body of a car which gives off a strong reflection
- Subjects in a photograph, some of which are close and some of which are in the distance, e.g. animals in a cage
- Subjects with a repetitive pattern, e.g. continuous windows in a building, etc.



## Using Focus Lock

Lock the focus when you want the subject to be off center, or when the subject is within 1.5 m/4.9 ft. of the camera.

### 1 Set the focus.

- Position the wide area AF frame over your subject and lightly press the shutter button halfway down. Keep the shutter button pressed halfway.

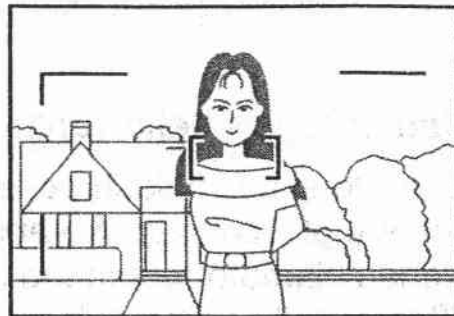

### 2 Compose the shot and take the picture.

- Compose the shot and press the shutter button fully.



- ⚠ Take care that the distance from the camera to the subject does not change. If the distance does change, lock the focus again.

## Close-up Photography

When the shooting distance is closer than 1.5 m/4.9 ft., there is a difference between what you see in the viewfinder and the picture you actually take, and therefore the part of the picture outside the close-up frame will be cut off.

After locking the focus on your subject, bring the subject into the close-up frame, compose the shot and take the picture.

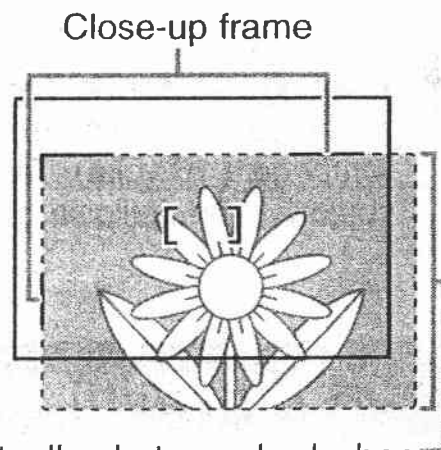





Area actually photographed when the lens is in the telephoto position (inside dotted line).

- ⚠ If the green lamp blinks, move away from the subject until the lamp stops blinking.

## Shooting with Self-timer

The self-timer function allows you to take a picture from a distance away from the camera when it is attached to a tripod.

### **1** Set the camera to self-timer mode.

- Press the  button.
- ➔  appears on the LCD panel.
- If you then press the  button again,  disappears and self-timer mode is cancelled.

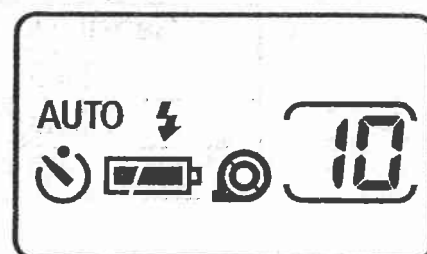



### **2** Compose the picture and press the shutter button.

- ➔ The self-timer lamp blinks and the shutter is released approximately 10 seconds later.
- To cancel the self-timer, press the  button again.

## Shooting with the Mode Button

### Select the shooting mode.

- Press the **MODE** button, and align ▼ with , **RT**.

  uses center-point AF to focus in the center of the wide area AF frame.

### Shooting Moving Objects

This mode selects servo autofocus, which keeps moving objects in focus, and the continuous shooting function.

- In low light or backlit conditions, the flash fires automatically.
- You may not be able to focus on subjects moving rapidly.
- The red-eye reduction function can not be set.
- The green lamp does not light.
- No camera shake warning is given.
- The camera continues to adjust the focus for 40 seconds while the shutter button is held down halfway.
- Even if set, the Real-time Release Custom Function (CF1) will not operate.

### Shooting against Dark Backgrounds

Use this mode when you are taking pictures of people against a sunset or nighttime background.

The flash illuminates the subject and the slow shutter speed captures the background, allowing you to take beautiful pictures.

- Follow the steps in autoflash mode to take a picture.
  - The red-eye reduction function will operate.
- You cannot change the flash mode.
  - No camera shake warning is given. Because of the slow shutter speeds (up to 2 seconds), you must use a tripod to keep the camera steady. You should also ensure that the subject does not move in the moment after the flash fires.

## Shooting Portraits

Use this mode when you want to lessen the impact of the background and highlight the subject.

The camera automatically zooms in, to a range of 1 to 3.7 m/3.3 to 12.1 ft. to frame from the waist up of the subject and fires the flash for every shot to produce highlights in the subject's eyes.

- Follow the steps in autoflash mode to take a picture.
- The red-eye reduction function will operate.

## Shooting Close-up

Use this mode when you want to take close-up pictures of flowers and insects.

You can get as close to 60 cm/2 ft. to the subject to take a picture. The shooting distance range is between 0.6 m/2 ft. to infinity.

- Refer to **Close-up Photography** for the procedure to shoot in close-up.

 The lens automatically zooms and locks into position. You cannot operate the zoom.

## **RT** Shooting in Real Time

Press the shutter button down halfway to focus on the subject and then press the button fully to take a picture in real time. This mode enables you to take pictures at the best moment.

 If you press the shutter button all the way down in a single movement, realtime release does not operate.

## Using Red-eye Reduction Function Effectively

When you use the flash to take photos of people in low light conditions, their eyes sometimes glow red in the photograph. This is referred to as the red-eye effect and is caused by the light of the flash being reflected off the retina of the eye.

When the red-eye reduction operates, the red-eye reduction lamp lights for approximately 1 second before the flash fires. This causes the subject's pupils to contract, minimizing the risk of red-eye.

- ① Take the picture from within 2 m/6.6 ft. of your subject.
  - ② Attract the subject's attention so that he or she looks at the camera.
- Set the lens to the wide-angle position.
  - Raise the available light level as much as possible.
  - The effectiveness of the red-eye reduction function varies from person to person.



When the red-eye reduction function operates, a picture can not be taken for approximately 1 second (the green lamp blinks 16 times). Hold down the shutter button until you hear the sound of the film winding on.

## Changing the Flash Mode

You can cause the flash to fire for every shot or suppress flash operation completely to suit the subject or location.

### Select the flash mode.

- Press the  button to select the mode you want.



### AUTO Autoflash

In dark places and in backlit conditions, the flash fires automatically.

#### Flash Distance Range (with color print film)

Film speed	Wide-angle	Telephoto
ISO 100	0.8–3.4 m (2.6–11.2 ft.)	1.0–2.5 m (3.3–8.2 ft.)
ISO 200	0.8–4.8 m (2.6–15.7 ft.)	1.0–3.5 m (3.3–11.5 ft.)
ISO 400	0.8–6.8 m (2.6–22.3 ft.)	1.0–5.0 m (3.3–16.4 ft.)



You can select whether the autoflash mode initially set when you turn the power on is AUTO  or AUTO . Set the camera to the desired autoflash mode and then switch the camera off.

## AUTO **Autoflash with Red-eye Reduction**

In dark places, the flash automatically fires after the red-eye reduction lamp has lit.

### **Flash ON (Fires for all shots)**

The flash fires when the picture is taken.

### **Flash ON with Red-eye Reduction (Fires for all shots)**

The flash always automatically fires after the red-eye reduction lamp has lit.

### **Flash OFF (Never fires)**

The flash does not fire.



+1.5



-1.5

### **Flash OFF with Manual Exposure Compensation**

There is automatic exposure compensation in backlit conditions but manual exposure compensation is also optional.



#### ● +1.5 **Exposure Compensation**

You can use this setting to prevent your subject being too dark (underexposed) when the surroundings are extremely bright, such as at a ski-resort or in backlit conditions.

#### ● -1.5 **Exposure Compensation**

You can use this setting to prevent your subject being too bright (overexposed) when the surroundings are extremely dark, such as on a spotlight stage.



Because of the slow shutter speeds in dark places in  ,  +1.5 , and  -1.5 modes, if the camera shake warning comes on (the green lamp blinks 16 times per second), you must use a tripod to keep the camera steady.

# Imprinting the Date and Time DATE

## 1 Select the Date mode.

- With the power off, press the **MODE** button.

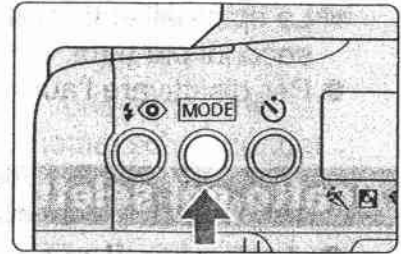

## 2 Select the date and time combination.

- By pressing the **[▲]** button, you can select the date and time combination. The display changes in the cycle shown below.

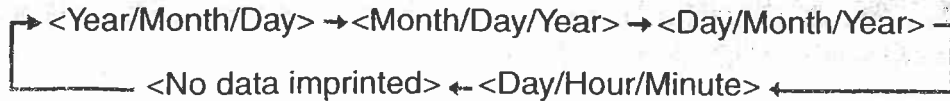

- Press the **MODE** button and the power switches off.



Date/time etc. imprinted here.

## ■ Setting the Date and Time

When you replace the battery or travel to the different time zone, use the following procedure to set or adjust the date and time settings.

### 1 Select the Date mode.

### 2 Press the **[▲▲▲]** button for more than 2 seconds for date/time set mode.

### 3 Press the **[▲▲▲]** button to select the setting position (numbers blinking).

- Setting position cycles through in the order **year-month-day-hour-minute-(:)**.

### 4 Press the **[▲]** button to set the number.

### 5 Repeat 3 and 4 above to set all digits of the date and time.

- Pressing the **[▲]** button while ":" is blinking resets the seconds (:) setting to zero.

### 6 Finish setting the date and time.

- Press the **[▲▲▲]** button and once ":" stops blinking, date and time setting is completed.
- Press the **MODE** button and the power switches off.

Setting the Date

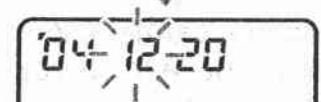
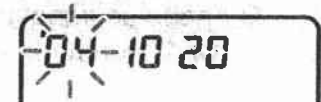

Setting the Time

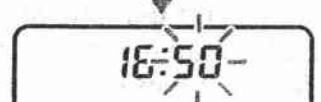
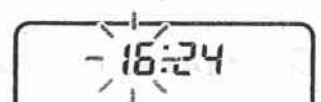
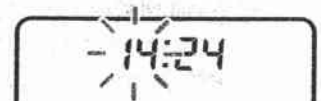



Each time the **[▲]** button is pressed, the number increases by one. If kept pressed, the number increases continuously.



## Setting the Custom Functions

You can customize the functions listed below to suit your preferences or the photography conditions.

### 1 Set the camera to Custom Function setting mode.

- With the power off, hold down the  button and press the  button.
- "CF 1-0" appears on the LCD panel.

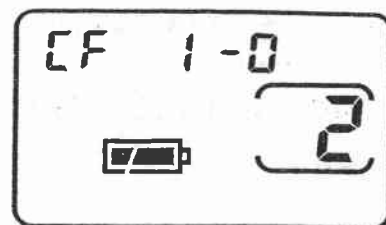

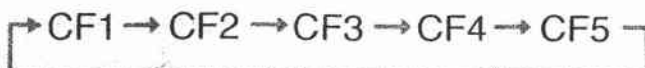

### 2 Select a function.

- Each time you press the  button, the Custom Function number changes in the cycle shown below.



### 3 Set the function.

- Press the  button to change the setting display to 1 (function enabled). Press the  button again to change the setting to 0 (function disabled).
- Turning the power on completes the settings.



#### CF1: Real-time Release

Refer to  **Shooting in Real Time** for information on using the Real-time Release function.

#### CF2: Shooting Mode and Flash Mode Memory

Stores the shooting mode and the flash mode in memory immediately before the camera is switched off. Useful when you always want to set the shooting mode and the flash mode to a particular mode.

#### CF3: Disabling Automatic Film Rewind

Useful for situations where you do not want the sudden sound of the film rewinding. When you reach the end of the roll, the number on the frame counter and the  blink. Press the  button to start film rewinding.

#### CF4: Center-point AF

A convenient function when you want to place your subject off center (using focus lock) or focus on one particular subject. The subject must be positioned in the center of the wide area AF frame.

#### CF5: Continuous Shooting

While the shutter button is pressed, you can take continuous shots.



- The Custom Functions were all set to zero (0) at the factory setting.
- The Custom Function settings are retained even when you switch the camera off and on, replace the film, or replace the battery.

## Major Specifications

**Type:** Fully-automatic 35 mm lens-shutter AF camera

**Image Size:** 24 × 36 mm

**Lens:** Canon zoom lens 38-150 mm f/5.6-11.3

**Focusing:** AI AF

**Viewfinder Coverage:** Approx. 84%

**Viewfinder Information:** Picture frame, Wide area AF frame, Close-up frame

Green lamp: Camera ready indicator/too-close warning/focusing-not-possible warning/release lock while the red-eye reduction lamp is lit/camera shake warning

**Shooting Distance:** Wide-angle: 0.8 m (2.6 ft.)-infinity

Telephoto: 1.0 m (3.3 ft.)-infinity

Close-up: 0.6 m (2 ft.)-infinity

**Film Speeds:** DX-coded ISO 25-3200 set automatically in full-stop increments

**Film Transport:** Automatic, mid-roll rewind

**Power Source:** One CR2 lithium battery

**Battery Life:** Approx. 14 rolls (24-ex. • normal temperature with 50% flash use)

**Dimensions (W × H × D):** 107 × 58.7 × 51.5 mm/4.2 × 2.3 × 2 in.

**Weight:** 200 g/7.1 oz. (excluding battery)

- All the specifications above are based on Canon's testing and measuring standards.
- Specifications and physical appearance are subject to change without notice.