

THE CAM IS MANUFACTURED BY:



Digital Camcorder 

VP-M102/M105/M110

- AF** Auto Focus
- CCD** Charge Coupled Device
- LCD** Liquid Crystal Display

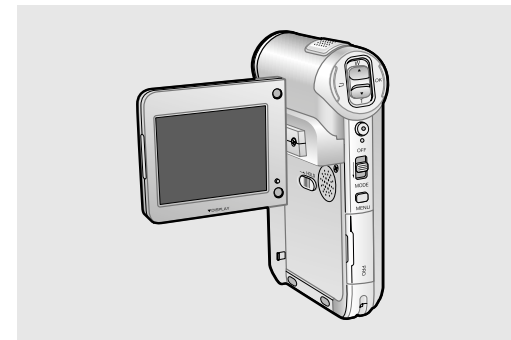

Owner's Instruction Book

Before operating the unit, please read this Instruction Book thoroughly, and retain it for future reference.

 This product meets the intent of
Directive 89/336 CEE, 73/23 CEE, 93/68 CEE.



Contents

Notices and Safety Precautions	8
Precautions on the CAM Care	8
Notes Regarding COPYRIGHT	9
Notes Regarding Moisture Condensation	9
Notes Regarding the CAM	9
Notes Regarding the Battery Pack	10
Notes Regarding a Trademark	10
Notes Regarding the Lens	11
Notes Regarding the LCD Display	11
Precautions Regarding Service	11
Precautions Regarding Replacement Parts	11
Getting to Know Your CAM	12
Features	12
Accessories Supplied with the CAM	13
Name of Each Part	14
Rear & Left View	14
Right & Bottom View	15
LCD Display	16
OSD(On Screen Display in Video Record Mode/Video Play Mode)	16
OSD(On Screen Display in Photo Capture Mode/Photo View Mode)	17
OSD(On Screen Display in MP3 Play Mode/Voice Record/Play Mode)	18
How to Use the Battery Pack	19
Battery Pack Installation / Ejection	19
Maintain the Battery Pack	20
Charging the Battery Pack	23

Contents

Getting Started	24
The Colour of the LED	24
Using Hardware Reset Function	24
Before You Start Operating the CAM	25
Using the Function Button	26
Using the Display Button	27
Adjusting the LCD Monitor	28
Structure of the Folders and Files	29
Recording Time and Capacity	30
Selecting the Memory Type	32
Using the Memory Stick	33
Mode and Menu Selection	34
Video Mode	35
Recording	36
Recording	36
Zooming In and Out	37
Playing	38
Playing on the LCD Monitor	38
Selecting File Options	40
Deleting Video files	40
Locking Video files	41
Copying Video files	42
Setting the PB Option	43
Setting Various Functions	44
Setting the Video file Size	44
Setting the Video file Quality	45
Setting the Focus	46
Setting the EIS (Electronic Image Stabilizer)	47
Setting the White Balance	48
Setting the Program AE (Programmed Auto Exposure)	49

Contents

Setting the BLC (Backlight Compensation).....	50
Setting the Effect.....	51
Setting the Digital Zoom.....	52
Photo Mode	53
Capturing	54
Capturing Images.....	54
Zooming In and Out.....	55
Viewing	56
Viewing Photo files on the LCD Monitor.....	56
Selecting File Options	57
Deleting Photo files.....	57
Locking Photo files.....	58
Setting DPOF(Digital Print Order Format) Function.....	59
Copying Photo files.....	60
Setting Various Functions	61
Setting the Photo file Size.....	61
Setting the Light.....	62
Setting the Focus.....	63
Setting the EIS (Electronic Image Stabilizer).....	64
Setting the White Balance.....	65
Setting the Program AE (Programmed Auto Exposure).....	66
Setting the BLC (Backlight Compensation).....	67
MP3 Mode	69
Storing Music in the CAM	70
Copying Music files to the CAM.....	70
Playing	71
Playing Music files.....	71
Selecting Play Options	72

Contents

Setting Repeat Play.....	72
Selecting File Options	73
Deleting Music files.....	73
Locking Music files.....	74
Copying Music files.....	75
Voice Recorder Mode	76
Recording	76
Recording Voice.....	76
Playing	77
Playing Voice files.....	77
Selecting File Options	78
Deleting Voice files.....	78
Locking Voice files.....	79
Copying Voice files.....	80
Using File Browser	81
Deleting Files or Folders	81
Locking Files	82
Copying Files or Folders	83
Viewing File Information	84
Setting the CAM	85
Adjusting the LCD Monitor	86
Adjusting the LCD Brightness.....	86
Adjusting the LCD Colour.....	87
Adjusting Date/Time	88
Setting Time.....	88
Setting Date.....	89
Setting Date Format.....	90
Setting Time Format.....	91

Contents

Setting the System	92
Setting the Auto Shut off.....	92
Setting the Demo Function.....	93
Setting Start-up Mode.....	94
Setting the File No. Function.....	95
Setting the Beep Sound.....	96
Viewing Version Information.....	97
Setting Memory	98
Selecting the Storage Type.....	98
Formatting the Memory.....	99
Viewing Memory Space.....	100
Using USB Mode	101
Storing Files to the External Memory.....	101
System Environment.....	102
Using PC Cam.....	103
Connecting the CAM to a Printer.....	104
Miscellaneous Information	105
Connecting the CAM with other Devices	106
Connecting the CAM to TV.....	106
Connecting the CAM to VCR or DVD Recorder.....	107
Copying Video files to a VCR Tape.....	108
Connecting the CAM to a PC using the USB cable.....	109
Installing Programs	110
Installing Image Mixer.....	110
Installing for using PC-Cam.....	112
Installing Windows98SE Driver(For only Windows98SE).....	113
Printing Photos	115
Printing with PictBridge Function.....	115
Printing Photos with DPOF Files.....	116

Contents

Maintenance	117
Cleaning and Maintaining the CAM	117
After using the CAM.....	117
Cleaning the Body.....	118
Using the Built-in Rechargeable Battery.....	118
Using the CAM Abroad.....	119
Troubleshooting	120
Self Diagnosis Display	120
Using the Menu	122
Specifications	124
Index	126
Power Sources (United Kingdom Only)	128

Notices and Safety Precautions

Precautions on the CAM Care

- ⌘ Please note the following precautions for use:
 - ⌘ Please keep this device in a safe place. The device contains a lens that can be damaged by shock. Keep away from the reach of the children.
-
- Do not place your device in a wet place. Moisture and water may cause the device to malfunction.
 - To avoid electric shock, do not touch your device or power cable with wet hands.
 - Do not use the flash close to another's eyes. The flash emits a strong light that may cause damage similar to direct sunlight on one's eyesight. Particular care should be observed if photographing infants, when the flash should be no less than 3 feet from your subject.
 - If the device is not working properly, please consult your nearest dealer or authorized Samsung service facility. Disassembling the device yourself may cause irrecoverable damage which will be difficult to repair.
 - Clean the device with a dry, soft cloth. Use a soft cloth moistened with a mild detergent solution for removing stains. Do not use any type of solvent, especially benzene, as they may seriously damage the finish.
 - Keep your device away from rain and saltwater. After using, clean the device. Saltwater may cause the parts to corrode.

Notices and Safety Precautions

Notes Regarding COPYRIGHT

- ⌘ Television programmes, movie video tapes, DVD titles, films and other programme materials may be copyrighted. Unauthorized recording of copyrighted materials may infringe on the rights of the Copyright owners and is contrary to copyright laws.
- ⌘ All the trade names and registered trademarks mentioned in this manual or other documentation provided with your Samsung product are trademarks or registered trademarks of their respective holders.

Notes Regarding Moisture Condensation

1. **A sudden rise in atmospheric temperature may cause condensation to form inside the CAM.**

For Example:

- ⌘ Entering or leaving a heated place on a cold day might cause condensation inside the product.
- ⌘ To prevent condensation, place the product in a carrying case or a plastic bag before exposing it to a sudden change of temperature.

Notes Regarding the CAM

1. **Do not leave the CAM exposed to high temperature (above 60°C or 140°F).**
For example, in a parked closed car in summer or exposed to direct sunlight.
2. **Do not let the CAM get wet.**
Keep the CAM away from rain, salt water, or any other form of moisture.
The CAM will be damaged if immersed in water or subjected to high levels of moisture.

Notices and Safety Precautions

Notes Regarding the Battery Pack

- ※ Make sure the battery pack is fully charged before starting to record.
- ※ To preserve battery power, keep the CAM turned off when you are not operating it.
- ※ If your device is left in STBY mode without being operated for more than 5 minutes, it will automatically turn itself off to protect against unnecessary battery discharge.
- ※ Make sure that the battery pack is attached firmly in place.
- ※ The new battery pack provided with the product is not charged. Before using the battery pack, you need to fully charge it.
- ※ Do not drop the battery pack. Dropping the battery pack may damage it.
- ※ Fully discharging a Lithium Polymer battery damages the internal cells. The battery pack may be prone to leakage when fully discharged.
- ※ To avoid damage to the battery pack, make sure to remove the battery when no charge remains.
- ※ Clean the terminal to remove foreign substance before inserting the battery pack.

- * When the battery reaches the end of its life, please contact your local dealer. Batteries must be disposed of as chemical waste.
- * Be careful not to drop the battery pack when you release it from the CAM.

Notes Regarding a Trademark

- ※ The logos regarding DivX, DivX Licensed are the trademark of DivX, Network, Inc and can be used after contracting license.

Notices and Safety Precautions

Notes Regarding the Lens

- ※ Do not film with the camera lens pointing directly at the sun. Direct sunlight can damage the CCD (Charge Coupled Device, the imaging sensor).

Notes Regarding the LCD Display

1. The LCD monitor has been manufactured using the high precision technology. However, there may be tiny dots (red, blue or green in colour) that appear on the LCD monitor. These dots are normal and do not affect the recorded picture in any way.
2. When you use the LCD monitor under direct sunlight or outdoors, it maybe difficult to see the picture clearly.
3. Direct sunlight can damage the LCD monitor.

Precautions Regarding Service

- ※ Do not attempt to service the CAM yourself.
- ※ Opening or removing covers may expose you to dangerous voltage or other hazards.
- ※ Refer all servicing to qualified service personnel.

Precautions Regarding Replacement Parts

- ※ When replacement parts are required, be sure the service technician has used replacement parts specified by the manufacturer and having the same characteristics as the original part.
- ※ Unauthorized substitutions may result in fire, electric shock or other hazards.

Getting to Know Your CAM

Features













- Integrated Digital CAM/DSC operation**
 An integrated digital imaging device that easily converts between a Digital CAM and a Digital Still Camera with comfortable and easy recording.
- High Resolution Image Quality (Digital Still Camera)**
 Employing 800K CCD Pixel, a maximum resolution of 800x600 is available.
- 100x Digital Zoom**
 Allows the user to magnify an image up to 100x its original size.
- Colourful TFT LCD**
 A high-resolution(210K) colourful TFT LCD gives you clean, sharp images as well as the ability to review your recorded files immediately.
- Electronic Image Stabilizer (EIS)**
 With the CAM, you can reduce unstable images by avoiding natural shaking movements.
- Various Digital Effects**
 The DSE (Digital Special Effects) allows you to give the film a special look by adding various special effects.
- USB Interface for Data Transfer**
 You can transfer still images and video file or any other files to a PC using the USB interface.
- PC Cam for multi-entertaining**
 You can use this the CAM as a PC camera for video chatting, video conference and other PC camera applications.
- Voice Record / Playback with vast memory**
 You can record voice and store it in the internal memory, Memory Stick and Memory Stick Pro(Optional) and playback the recorded voice.
- Plus Advantage, MP3**
 With the CAM, you can playback the MP3 file stored in the internal memory, Memory Stick and Memory Stick Pro(Optional). Enjoy your favourite songs with the MP3 files with the CAM.

Getting to Know Your CAM

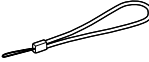
Accessories Supplied with the CAM

- ※ Make sure that the following basic accessories are supplied with your CAM.

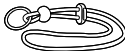
- Lithium Polymer Battery pack
- AC Power Adapter
- Video/Audio Cable
- USB Cable
- Cradle
- Earphones
- Hand Strap
- Carrying Case
- Instruction Book/Quick Guide
- Software CD
- Lens Cover
- Neck Strap
- Scart Adapter(Optional)
- Extended life Battery Pack(Optional)

1. Lithium Polymer Battery pack 	2. AC Power Adapter 	3. Video/Audio Cable 
4. USB Cable 	5. Cradle 	6. Earphones 
7. Hand Strap 	8. Carrying Case 	9. Instruction Book/Quick Guide 
10. Software CD 	11. Lens Cover 	12. Neck Strap 
13. Scart Adapter(Optional) 	14. Extended life Battery Pack(Optional) 	

Name of Each Part

Rear & Left View

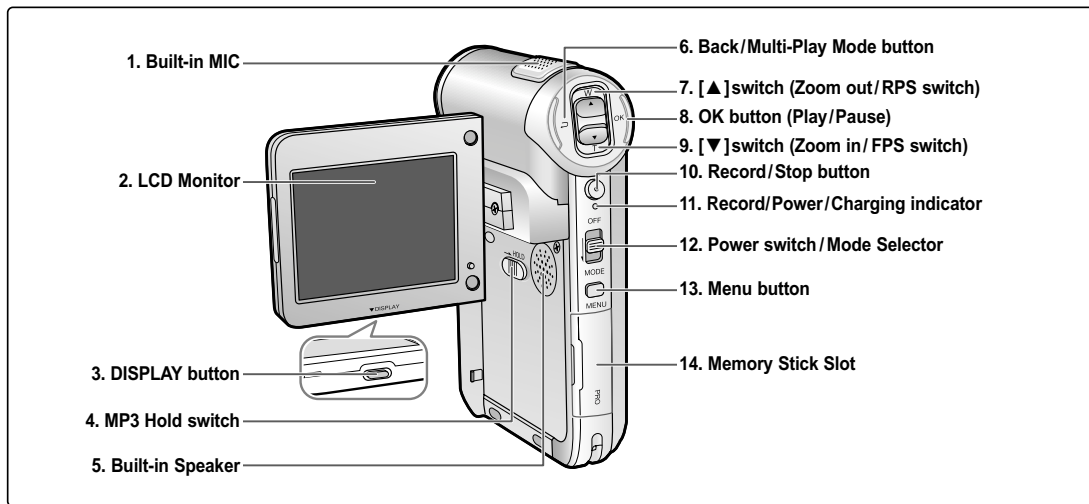

- 1 Built-in MIC
- 2 LCD Monitor
- 3 DISPLAY button
- 4 MP3 Hold switch
- 5 Built-in Speaker
- 6 Back/Multi-Play Mode button
- 7 [▲] switch (Zoom out/RPS switch)

- 8 OK button (Play/Pause)
- 9 [▼] switch (Zoom in/FPS switch)
- 10 Record/Stop button
- 11 Record/Power/Charging indicator
- 12 Power switch/Mode Selector
- 13 Menu button
- 14 Memory Stick Slot

Name of Each Part

Right & Bottom View

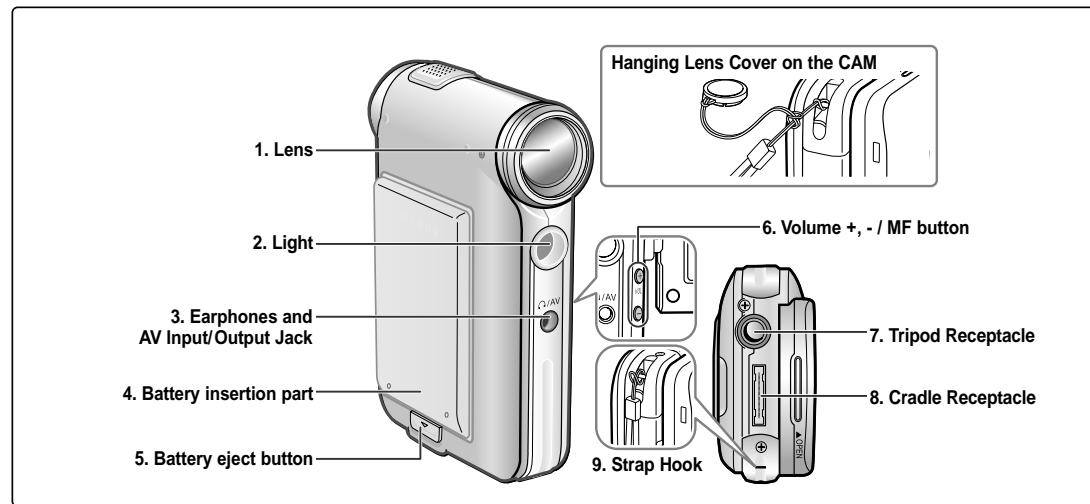

- 1 Lens
- 2 Light
- 3 Earphones and AV Input/Output Jack
- 4 Battery insertion part
- 5 Battery eject button

- 6 Volume +, - / MF button
- 7 Tripod Receptacle
- 8 Cradle Receptacle
- 9 Strap Hook

Name of Each Part: LCD Display

OSD (On Screen Display in Video Record Mode/Video Play Mode)

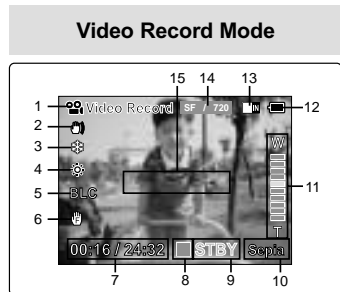

1. Mode indicator
2. EIS indicator
3. Program AE indicator
4. White Balance indicator
5. BLC indicator
6. Focus indicator
7. Counter
(Elapsed time/Remaining time)
8. Record/Standby indicator
9. Record/Standby text
10. Effect indicator
11. Zoom in/Zoom out indicator
12. Battery life indicator
13. Memory type indicator
14. Image quality/size indicator
15. Warning and note indicator

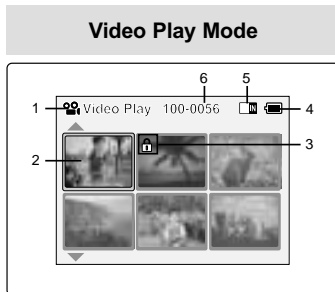

1. Mode indicator
2. Current display indicator
3. Lock indicator
4. Battery life indicator
5. Memory type indicator
6. Image counter (Current image)

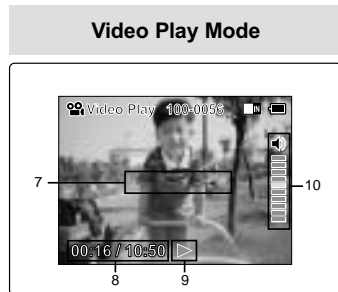

7. Warning and note indicator
8. Counter
9. Operation indicator
(Play/Pause/RPS/FPS)
10. Volume indicator

Note

※ Functions you've set will not be canceled if you turn the CAM on again.

Name of Each Part: LCD Display

OSD (On Screen Display in Photo Capture Mode/Photo View Mode)

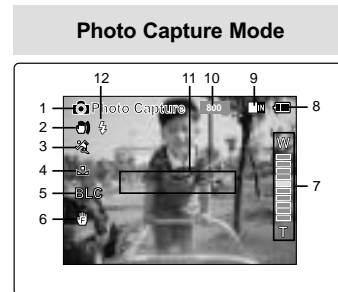

1. Mode indicator
2. EIS indicator
3. Program AE indicator
4. White balance indicator
5. BLC indicator
6. Focus indicator
7. Zoom in/out indicator
8. Battery life indicator
9. Memory type indicator
10. Image size indicator
11. Warning and note indicator
12. Light indicator

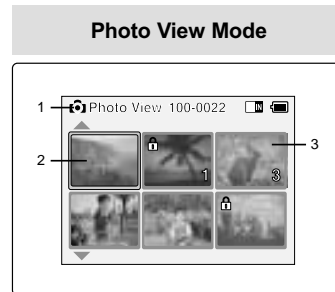

1. Mode indicator
2. Current display indicator
3. Number of print



4. Printer indicator
5. Lock indicator
6. Image counter (Current image)

Note

※ Functions you've set will not be canceled if you turn the CAM on again.

Name of Each Part: LCD Display

OSD (On Screen Display in MP3 Play Mode/Voice Record/Play Mode)

MP3 Play Mode

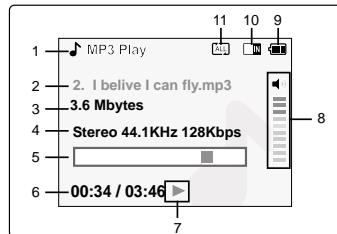

1. Mode indicator
2. File number / File name / File format
3. File size
4. Sampling Rate/Bit Rate
5. Progress Bar
6. Elapsed time/Full time
7. Operation indicator
8. Volume indicator
9. Battery life indicator
10. Memory type indicator
11. Repeat all/one indicator

Voice Record Mode

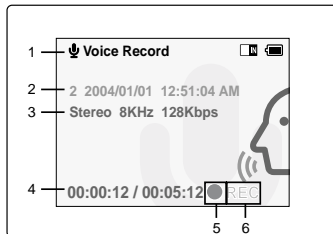

1. Mode indicator
2. File number/Date and Time
3. Sampling Rate/Bit Rate
4. Elapsed time/Full time
5. Operation indicator
6. Record/Standby text

Voice Play Mode

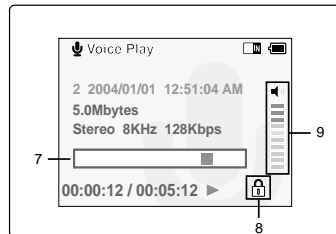

7. Progress Bar
8. Lock indicator
9. Volume indicator

Note

※ Functions you've set will not be canceled if you turn the CAM on again.

How to Use the Battery Pack

Battery Pack Installation / Ejection

It is recommended you purchase one or more additional battery packs to allow continuous use of your CAM.

To insert the battery pack

Slide the battery pack into the groove until it clicks.

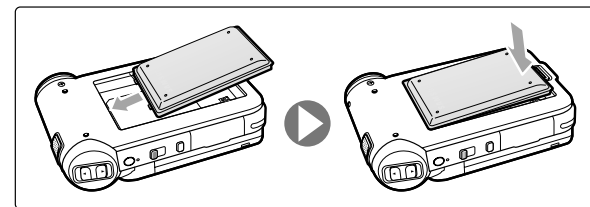

To eject the battery pack

Pull the [Battery Eject] button to eject the battery pack.

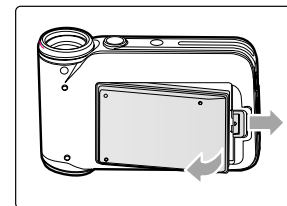

Note

※ Clean the terminals to remove foreign substances before inserting the battery pack.

How to Use the Battery Pack

Maintain the Battery Pack

- ※ The battery pack should be recharged in an environment of between 32°F(0°C) and 104°F(40°C).
- ※ The battery pack should never be charged in a room temperature that is below 32°F(0°C).
- ※ The life and capacity of the battery pack will be reduced if it is used in temperatures below 32°F(0°C) or left in temperatures above 104°F(40°C) for a long period.
- ※ Do not put the battery pack near any heat sources (fire or flames, for example).
- ※ Do not disassemble, process, press or heat the Battery Pack.
- ※ Do not allow the + and - terminals of the battery pack to be short-circuited. It may cause leakage, heat generation, induce fire and overheating.

How to Use the Battery Pack

Continuous recording time based on battery type

If you close the LCD screen, it switches off automatically.

The continuous recording time given in the table below is approximations. Actual recording time depends on usage.

Battery	Time	Continuous Recording Time	
		LCD ON	LCD OFF
SB-P90A (900mAh)		60 min.	80 min.
SB-P180A (1800mAh) (option)		120 min.	160 min.

Notes

- ※ Prepare an extra battery if you use the CAM outdoors.
- ※ Contact the Samsung service centre to purchase new battery pack.
- ※ If you zoom in or out, the recording time becomes shorter.

Warning

- ※ When you eject the battery pack from the CAM, hold the battery pack to prevent it dropping to the floor.

How to Use the Battery Pack

Battery Level Display

The Battery Level Display shows the amount of battery power remaining in the Battery Pack.

Battery Level Indicator	State	Message
	Fully charged	-
	40~60% used	-
	60~80% used	-
	80~95% used	-
	Exhausted(flickers) The device will soon turn off. Change the Battery Pack as soon as possible.	-
	(flickers) The device will be forced to turn off after 5 seconds.	"Battery Low"



Tips for Battery Identification

A charge mark is provided on the battery pack to help you remember whether it has been charged or not. If the battery has been fully charged, the charge indicator is green. If you are charging the battery, the colour of the charge indicator is orange. The charge indicator flickers if the battery is abnormal.

Charging time based on battery type

Capacity	Power On	Power Off
SB-P90A (900mAh)	6 hr. 30 min	1 hr. 40 min
SB-P180A (1800mAh) (option)	13 hr.	3 hr. 20 min

How to Use the Battery Pack

Charging the Battery Pack

1. Move [Mode Selector] up to turn the CAM off.
2. Attach the Battery Pack to the CAM.
3. Fix the CAM into the cradle.
4. Connect the jack with the cradle.
◆ Detach the jack by pressing the buttons of the jack.
5. Insert the AC power adapter into the outlet.

Note

- ※ You can charge the battery pack when you use the CAM.
Connect the AC power adapter with the CAM directly.

Warning

- ※ It is recommended you fully charge the battery pack before use.
- ※ You should only charge the battery in an environment between 0°C and 40°C.

Charging through the cradle

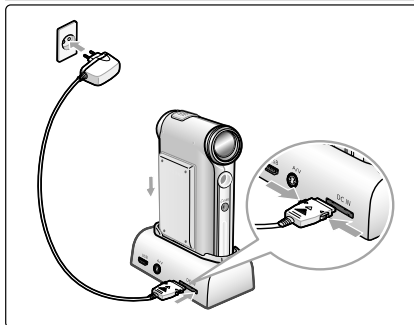

Charging directly to the CAM

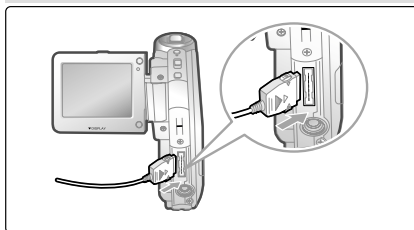

Getting Started

The Colour of the LED

The colour of the LED varies depending on the state of power or charging.

When the AC Adapter is plugged in

LED Colour	Power	Charging state
Red	Voice / Video Record	-
Green	On	-
Orange	Off	Charging
Green	Off	Fully charged
Orange Blink	-	Error

When the AC Adapter is unplugged

LED Colour	Power	Charging state
Green	On	-
Off	Off	-
Red	Voice / Video Record	-

Using Hardware Reset Function

1. Remove the battery pack and the AC adapter.
2. Turn the LCD monitor at an angle of 270°.
3. Press the [Display] button.
 - ◆ If you connect the AC adapter or insert the battery pack again, the CAM is reset and turns on.

Notes

- ※ If the LCD monitor is closed completely, the CAM makes a sound.
- ※ If you reset the CAM, all functions you set are initialized.

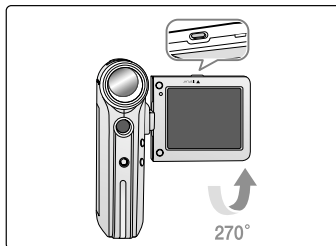

Getting Started

Before You Start Operating the CAM

Before using the CAM, refer to this page for easy operation. The Memory Stick is an optional accessory.

1. Install the battery pack and insert the Memory Stick into the Memory Stick slot. (Refer to page 33)
2. Charge the battery pack by fixing the CAM into the cradle and connecting the power cable to the cradle. (Refer to page 23)
3. Move [Mode Selector] down to turn on the CAM and move it down again.
 - ◆ You can select Video mode or Previous mode as the start-up mode in System Settings. (Refer to page 94)
4. Move the [▲/▼] switch to select the desired mode and press the [OK] button.
5. Press the [OK] button to take pictures, record, hear music or record voice. Press the [Menu] button to view the menu.
6. When you finished, turn the CAM off moving [Mode Selector] up.

For example: If you want to select Photo Mode

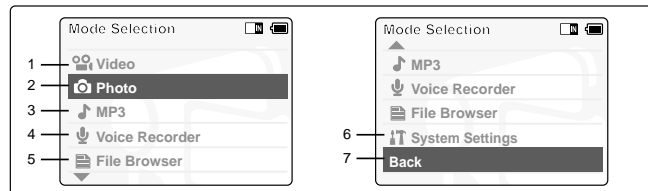

1. Video: You can record and play video files.
2. Photo: You can take and view photo files.
3. MP3: You can download and hear the music.
4. Voice Recorder: You can record and hear the voice.
5. File Browser: You can delete, lock, copy the file and view the file information.
6. System Settings: You can set the LCD monitor brightness/colour, date/time, system and memory.
7. Back: The screen moves to previous menu in the selected mode.

Getting Started

Using the Function Button

The Function button is used to make a selection, move the cursor, select the functions and exit from the menu.

The Use of Various Function button

Button	Recording/ Picture taking	Playing/Viewing	Selecting
	Zoom out (▲)	RPS (◀◀)	Select up
	Zoom in (▼)	FPS (▶▶)	Select down
	Multi-Play screen	Multi-Play screen	Return to previous menu
	Change from Record/ Capture to Play/View	Play/Pause	Confirm selecting

Note

- * If there is no file when you press the [OK] button in Video Record/Photo Capture, no change occurs.
- * Refer to page 39 for further details about the function button.

The Use of [Back] and [Menu] button

Button	Video Record/Photo Capture	Video Play/Photo View
	Move to Video Play/ Photo View	Move to Video Record/ Photo Capture
 MENU (Press for about 2 seconds)	Move to <Settings>	Move to <File Options>

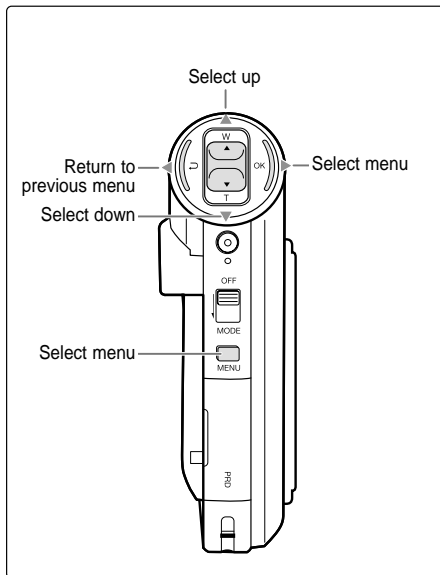

Getting Started

Using the Display button

You can use various functions pressing the [Display] button.

1. Open the LCD monitor.
2. Move [Mode Selector] down to turn on the CAM.
 - ◆ The video screen appears.
 - ◆ You can select Video mode or Previous mode as the start-up mode in System Settings. (Refer to page 94)
3. Press the [Display] button.

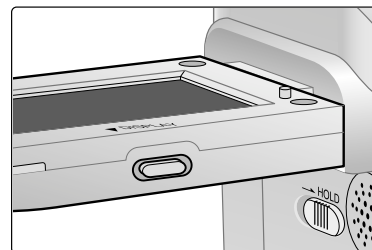

If you press the [Display] button

- * Once: The display indicators turn off.
- * Twice: The back light turns off.
- * 3 times: It returns to the initial screen.
- * Hold down the button for 2 seconds: The [Help] screen according to each mode appears.

Record/Capture Help

Record/Capture Help

Play Mode, Record, Off, Mode Selection, Zoom Out, Play Last, Zoom In, Menu

Select Mode Help

Select Mode

Back, Off, Close Mode Selection, Up, Select, Down, Open/Close Menu

Time/Date Dialog Help

Time/Date Dialog Help

Cancel, Off, Mode Selection, Up, Next, Down, Menu

Play Help

Play Help

Back, Off, Mode Selection, Prev./Rew, Play, Next/FF, Menu

Getting Started

Adjusting the LCD Monitor

Your the CAM is equipped with a colour Liquid Crystal Display monitor, which enables you to view directly what you are recording or playing back. Depending on the conditions under which you are using the CAM (indoors or outdoors for example), you can adjust the LCD Brightness or Colour.

1. Move [Mode Selector] down to turn on the CAM and move it down again.
 - ◆ The Mode Selection screen appears.
2. Move the [▲/▼] switch to select *System Settings* and press the [OK] button.
3. Move the [▲/▼] switch to select <Display> and press the [OK] button.
4. Move the [▲/▼] switch to select <LCD Brightness> or <LCD Colour> and press the [OK] button.
5. Move the [▲/▼] switch to select desired brightness or colour and press the [OK] button.
 - ◆ Refer to page 86~87 for details.

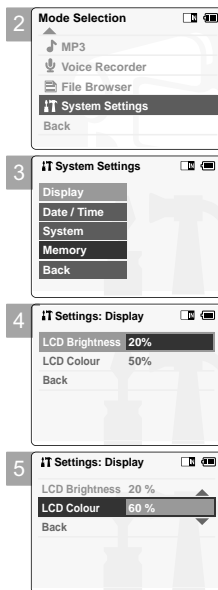

Notes

- ☞ If you select [Back] in the menu, the previous menu appears.
- ☞ If it is too bright, adjust the LCD Brightness.

Getting Started

Structure of the Folders and Files

The video files and photo files are stored in internal memory, Memory Stick or Memory Stick Pro as below.

Notes

- ☞ Refer to page 33 for details about Memory Stick.
- ☞ You can store general data in files and folders of the CAM.
- ☞ The number of the file is up to 9,999 and folder is up to 100.
- ☞ DCAM****.JPG: Photo file
SMOV****.AVI: Video file
SWAV****.WAV: Voice file
*****.MP3: MP3 file
- ☞ MISC: DPOF files are stored.
- ☞ Do not change the file or folder name except 'Free'.
- ☞ You can freely change the file or folder name of 'Free'.
- ☞ Video files that you have not made with the CAM may not be able to be played.

Warning

- ☞ Do not turn the power off while recording, playing, erasing file or formatting the Memory Stick.
- ☞ Please turn the power off before you insert or eject the Memory Stick to avoid losing data.
- ☞ Save important files separately.

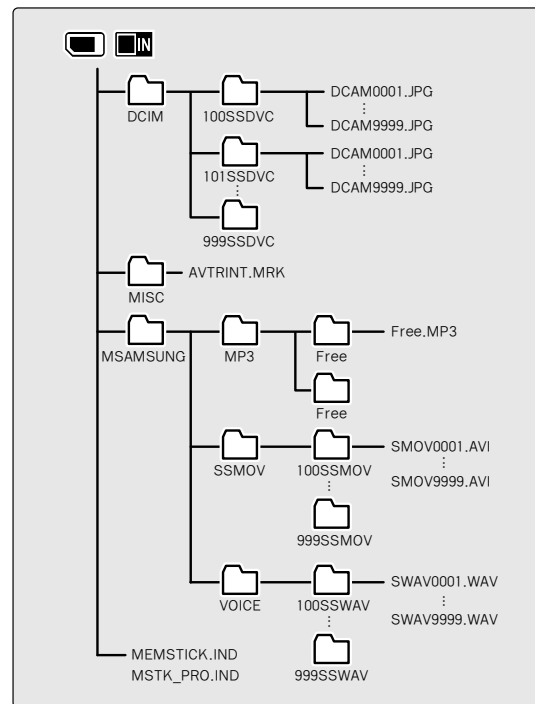

Getting Started

Recording Time and Capacity

Video Record Time

Media	Capacity	Super Fine		Fine		Normal	
		352	720	352	720	352	720
Internal Memory	256MB(VP-M102)	approx. 10min.	approx. 5min.	approx. 16min.	approx. 8min.	approx. 32min.	approx. 16min.
	512MB(VP-M105)	approx. 21min.	approx. 10min.	approx. 32min.	approx. 16min.	approx. 65min.	approx. 32min.
	1GB(VP-M110)	approx. 44min.	approx. 22min.	approx. 66min.	approx. 33min.	approx. 132min.	approx. 66min.
Memory Stick	32MB	X	X	approx. 2min.	X	approx. 4min.	approx. 2min.
	64MB	X	X	approx. 4min.	X	approx. 8min.	approx. 4min.
	128MB	X	X	approx. 8min.	X	approx. 16min.	approx. 8min.
Memory Stick Pro	256MB	approx. 10min.	approx. 5min.	approx. 15min.	approx. 7min.	approx. 30min.	approx. 15min.
	512MB	approx. 20min.	approx. 10min.	approx. 31min.	approx. 15min.	approx. 62min.	approx. 31min.
	1GB	approx. 42min.	approx. 21min.	approx. 63min.	approx. 31min.	approx. 126min.	approx. 63min.

Warning

- ※ The compressibility is changed automatically depending on the recorded images and the maximum recording time and capacity can be changed in 'Video Record'.
- ※ You may be not able to record or play normal video files if you use the Memory Stick over 1GB capacity.
- ※ You can record video files with size of 720/Normal, 352/Fine and 352/Normal in the Memory Stick but the quality is not guaranteed.
- ※ If you record video files with the quality of Normal(352/720) in the internal memory, Memory Stick or Memory Stick Pro, the recording time becomes longer but the video may have lower quality than other quality level.
- ※ The recording time and capacity may vary by generating the bad sector when you record video files in the Memory Stick and Memory Stick Pro.

Getting Started

Number of Photo Capture

Media	Capacity	Quality	
		800X600	640X480
Internal Memory	256MB	approx. 2509	approx. 4129
	512MB	approx. 5019	approx. 8258
	1GB	approx. 9803	approx. 16129
Memory Stick	32MB	approx. 313	approx. 516
	64MB	approx. 627	approx. 1032
	128MB	approx. 1254	approx. 2064
Memory Stick Pro	256MB	approx. 2509	approx. 4129
	512MB	approx. 5019	approx. 8258
	1GB	approx. 9803	approx. 16129

Voice Record Time

Media	Capacity	Time
Internal Memory	256MB	approx. 4hr.
	512MB	approx. 8hr.
	1GB	approx. 18hr.
Memory Stick	32MB	approx. 33min.
	64MB	approx. 1hr.
	128MB	approx. 2hr.
Memory Stick Pro	256MB	approx. 4hr.
	512MB	approx. 8hr.
	1GB	approx. 17hr.

Notes

- ※ The recording time and capacity is an approximation.
- ※ You can format the Memory Stick on the CAM. (Refer to page 99)
- ※ Do not format the Memory Stick or Memory Stick Pro on the PC.
- ※ The recording time and the number of images shown are maximum figures based on using one function. In actual use, using more than one function will reduce the capacity of each.
- ※ If you set the light, you can take fewer photos than mentioned number of image.
- ※ If you format the Memory Stick or Memory Stick Pro, use the Memory Stick Formatter in the supplied software CD.

Getting Started

Selecting the Memory Type

You can select the memory type - internal memory or external memory (Memory Stick, Memory Stick Pro).
The Memory Stick is an optional accessory.
The video file and the photo files are stored in internal memory by default.

1. **Insert the Memory Stick.** (Refer to page 33)
2. **Move [Mode Selector] down to turn on the CAM and move it down again.**
◆ The Mode Selection screen appears.
3. **Move the [▲/▼] switch to select *System Settings* and press the [OK] button.**
4. **Move the [▲/▼] switch to select <Memory> and press the [OK] button.**

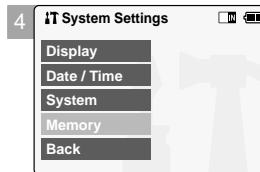
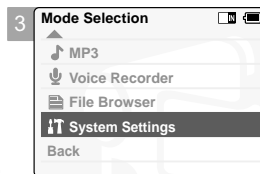

5. **Move the [▲/▼] switch to select <Storage Type> and press the [OK] button.**

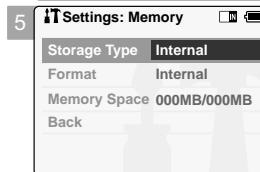

6. **Move the [▲/▼] switch to select desired type and press the [OK] button.**
◆ You can select external or internal memory.

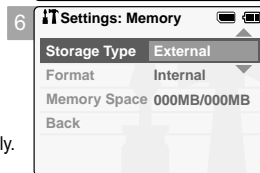

Note

- ⌘ If you insert the Memory Stick or Memory Stick Pro, the memory type selection screen appears automatically.

Getting Started

Using the Memory Stick

Inserting a Memory Stick

1. **Open the LCD monitor.**
2. **Open the Memory Stick slot lid.**
3. **Insert the Memory Stick into the slot until it softly clicks.**
4. **Close the slot lid.**
5. **The pop-up screen appears.**
◆ If you select <OK>, the memory type changes to 'External' and if you select 'Cancel', files are stored in internal memory continuously.
◆ If you insert locked Memory Stick, the [🔒] icon is displayed next to the memory type indicator.

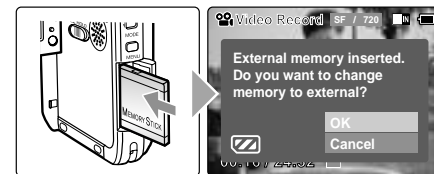

Ejecting a Memory Stick

1. **Open the LCD monitor.**
2. **Open the Memory Stick slot lid.**
3. **Slightly push the Memory Stick inwards to pop it out.**
4. **Pull the Memory Stick out of the slot and close the lid.**

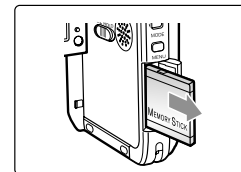

Notes

- ⌘ Do not apply excessive force when you insert / eject the Memory Stick.
- ⌘ Do not turn the power off while recording, playing, erasing files or formatting the Memory Stick.
- ⌘ Please turn the power off before you insert or eject the Memory Stick to avoid losing data.
- ⌘ Do not place the Memory Stick near a strong electro-magnetic device.
- ⌘ Do not allow metal substances to come in contact with the terminals on the Memory Stick.
- ⌘ Do not bend the Memory Stick.
- ⌘ After pulling the card out from the CAM, keep the Memory Sticks in a soft case to prevent static shock.
- ⌘ The data stored on the card may be changed or lost as a result of misuse, static electricity, electric noise or repair. Save important files separately.
- ⌘ Samsung is not responsible for data loss due to misuse.



- ⌘ Memory Stick and  are trademarks of Sony Corporation.
- ⌘ All other product names mentioned herein may be the trademarks or registered trademarks of their respective companies. TM will not be mentioned in every instance in this manual.

The Memory Stick View

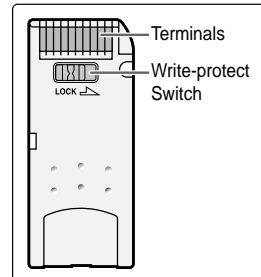

Getting Started

Mode and Menu Selection

You can select the mode and menu as follows. There are 2 ways of selecting menu. Select the way you prefer.

Mode Selection

1. Select the modes moving the [▲/▼] switch and pressing the [OK] button.

Menu Selection

1. Select the menus moving the [▲/▼] switch.
2. Select the menus pressing [Menu] button after pressing the [OK] button.
 - ◆ The menu screen appears.



SPECIAL OPERATION

1. Press the [Menu] button for 2 seconds.
 - ◆ The menu screen of the selected mode appears.

Note

- ※ User's manual only describes the first way of performing an operation. There may be other and more convenient ways for you to use the CAM.

1 Video Mode

Recording	36
Recording	36
Zooming In and Out	37
Playing	38
Playing on the LCD Monitor	38
Selecting File Options	40
Deleting Video files	40
Locking Video files	41
Copying Video files	42
Setting the PB Option	43
Setting Various Functions	44
Setting the Video file Size	44
Setting the Video file Quality	45
Setting the Focus	46
Setting the EIS	47
Setting the White Balance	48
Setting the Program AE	49
Setting the BLC	50
Setting the Effect	51
Setting the Digital Zoom	52

Note

- ※ You can set the time and date in System Settings. Refer to pages 88-89.

Video Mode : Recording

Recording

You can record moving person and objects and store it in memory.

1. **Move [Mode Selector] down to turn on the CAM.**
 - ◆ The Video Record screen appears.
 - ◆ You can select Video mode or Previous mode as the start-up mode in System Settings. (Refer to page 94)
2. **Press [Record/Stop] button to start recording.**
 - ◆ [● REC] indicator displays on LCD.
 - ◆ The elapsed time is displayed and it starts recording.
3. **Press the [Record/Stop] button again to stop recording.**
 - ◆ It stops recording and the CAM is ready again.
4. **Move [Mode Selector] up to turn off the CAM.**

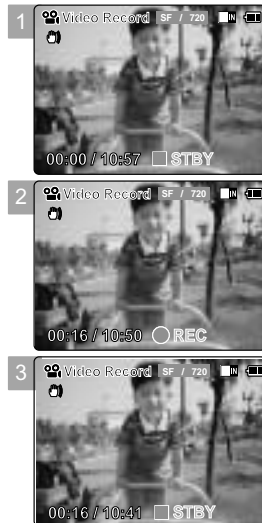

Notes

- * If you press the [Record] button and press it in 1 second, new video file is not made.
- * If the Auto Shut Off is set, the CAM turns off automatically after 5 minutes.
- * Detach the Battery Pack when you finish recording to prevent unnecessary battery power consumption.
- * You can check the recording time.

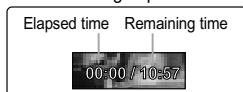

Video Mode : Recording

Zooming In and Out

Zooming technique lets you change the size of the subject captured in a scene.

1. **Move [Mode Selector] down to turn on the CAM.**
 - ◆ You can select Video mode or Previous mode as the start-up mode in System Settings. (Refer to page 94)
2. **Press the [Record/Stop] button to start recording.**



Move the [▲/▼] switch up to zoom out.

- The subject appears farther away when you zoom out.



Move the [▲/▼] switch down to zoom in.

- The subject appears closer when you zoom in.

Zoom Out



Zoom In



Notes

- * Frequent use of zooming may result in higher battery power consumption.
- * Refer to page 52 about Digital Zoom.

Video Mode : Playing

Playing on the LCD Monitor

It is handy and practical to view video files using the LCD monitor almost anywhere such as in a car, indoors or outdoors.

- Move [Mode Selector] down to turn on the CAM.**
 - ◆ The Video Record screen appears.
 - ◆ You can select Video mode or Previous mode as the start-up mode in System Settings. (Refer to page 94)
- Press the [Menu] button and move the [▲/▼] switch.**
Press the [OK] button after selecting <Play>.
- Move the [▲/▼] switch to find the video file you want to play.**
 - ◆ Each time you move the [▲/▼] switch, the frame moves horizontally.
 - ◆ Each time you press the [+]/[-] button, a page(6 frame) moves.
- Press [OK] button to play the video file you want.**
 - ◆ Each time you press the [OK] button, play or pause is selected repeatedly.
- Press the [Back] button after pressing the [OK] button to stop playing.**



Video Mode : Playing

The button and switch you use when playing the video file

[OK] Button: Play or pause the video file

[▲] Switch: In Video Record mode: Press it to move to previous file.

Press and hold it to use RPS function. (RPS rate: -x2, -x4, -x8, -x16, -x32, -x64, -x128)

[▼] Switch: In Video Record mode: Press it to move to next file.

Press and hold it to use FPS function. (FPS rate: x2, x4, x8, x16, x32, x64, x128)

In Video Play mode: Press it and hold it to play slowly when paused.

Press it to move to the next frame when paused.

Adjusting the Sound

- Press the [OK] button to play the video file.
- Press the [+] button to increase the volume.**
 - ◆ Each time you press the [+] button, the volume bar increases and the sound level will get louder.
 - ◆ The volume bar disappears after 1~2 seconds.
- Press the [-] button to decrease the volume.**
 - ◆ Each time you press the [-] button, the volume bar decreases and the sound level will get quieter.
 - ◆ The volume bar disappears after 1~2 seconds.



Notes

- * You can adjust the volume up to 10 steps.
- * You can also play the video file on a TV screen by connecting the CAM to a TV. (Refer to page 106)
- * It is necessary to install Image Mixer for playback the CAM recorded video files on your PC.

Video Mode : Selecting File Options

Deleting Video files

You can delete video files in <File Options>.

1. Move [Mode Selector] down to turn on the CAM.
 - ◆ The Video Record screen appears.
 - ◆ You can select Video mode or Previous mode as the start-up mode in System Settings. (Refer to page 94)
2. Press the [Menu] button and move the [▲/▼] switch. Press the [OK] button after selecting [Play].
3. Move the [▲/▼] switch to select the video file you want to delete.
4. Press the [Menu] button to select <File Options> and press the [OK] button.
 - ◆ You can select <File Options> only in <Play>.
5. Move the [▲/▼] switch to select <Delete> and press the [OK] button.
6. Move the [▲/▼] switch to select the followings. Press the [OK] button.
 - ◆ **Selected:** The selected video file is deleted.
 - ◆ **All:** All video files are deleted.
 - ◆ **Cancel:** Cancel deleting video files.

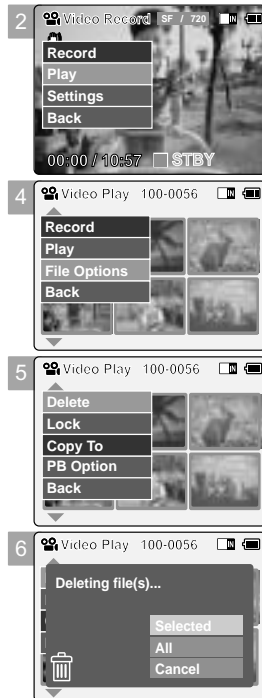

Note

* Press and hold the [Menu] button in Video Play, you can move to <File Options> directly.

Video Mode : Selecting File Options

Locking Video files

You can lock the important video file to prevent accidental deletion.

1. Move [Mode Selector] down to turn on the CAM.
 - ◆ The Video Record screen appears.
 - ◆ You can select Video mode or Previous mode as the start-up mode in System Settings. (Refer to page 94)
2. Press the [Menu] button and move the [▲/▼] switch. Press the [OK] button after selecting <Play>.
3. Move the [▲/▼] switch to select the video file you want to lock.
4. Press the [Menu] button to select <File Options> and press the [OK] button.
 - ◆ You can select <File Options> only in <Play>.
5. Move the [▲/▼] switch to select <Lock> and press the [OK] button.
6. Move the [▲/▼] switch to select the followings and press the [OK] button.
 - ◆ **Selected:** The selected video file is locked.
 - ◆ **All:** All video files are locked.
 - ◆ **Cancel:** Cancel locking video files.

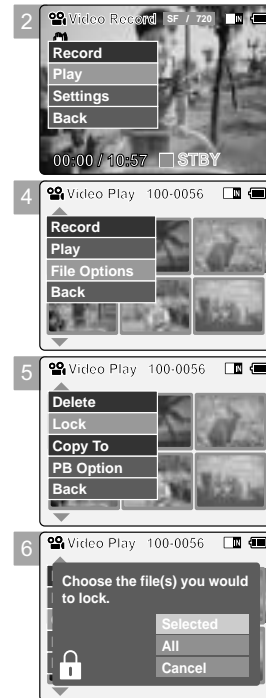

Notes

- * Press and hold the [Menu] button in Video Play, you can move to <File Options> directly.
- * The <🔒> icon is displayed on the locked file.

Video Mode : Selecting File Options

Copying Video files

You can copy the video file to the internal or external memory.

1. **Move [Mode Selector] down to turn on the CAM.**
 - ◆ The Video Record screen appears.
 - ◆ You can select Video mode or Previous mode as the start-up mode in System Settings. (Refer to page 94)
2. **Press the [Menu] button and move the [▲/▼] switch.**
Press the [OK] button after selecting <Play>.
3. **Move the [▲/▼] switch to select the video file you want to copy.**
4. **Press the [Menu] button to select <File Options> and press the [OK] button.**
 - ◆ You can select <File Options> only in <Play>.
5. **Press the [▲/▼] switch to select <Copy To> and press the [OK] button.**
 - ◆ If you selected the Storage type 'External', the file is copied to 'Internal'.
6. **Move the [▲/▼] switch to select the followings and press the [OK] button.**
 - ◆ **Selected:** Copy the selected video file.
 - ◆ **All:** Copy all video files.
 - ◆ **Cancel:** Cancel copying video files.

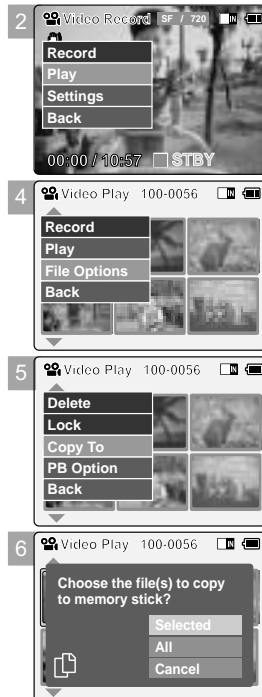

Note

* Press and hold the [Menu] button in Video Play, you can move to <File Options> directly.

Video Mode : Selecting File Options

Setting the PB Option

You can play all files continuously or play only selected file.

1. **Move [Mode Selector] down to turn on the CAM.**
 - ◆ The Video Record screen appears.
 - ◆ You can select Video mode or Previous mode as the start-up mode in System Settings. (Refer to page 94)
2. **Press the [Menu] button and move the [▲/▼] switch.**
Press the [OK] button after selecting <Play>.
3. **Move the [▲/▼] switch to select the video file you want to set the function.**
4. **Press the [Menu] button to select <File Options> and press the [OK] button.**
 - ◆ You can select <File Options> only in <Play>.
5. **Press the [▲/▼] switch to select <PB Option> and press the [OK] button.**
6. **Move the [▲/▼] switch to select the following and press the [OK] button.**
 - ◆ **Selected:** Play the selected video file.
 - ◆ **All:** Play all video files.
 - ◆ **Cancel:** Cancel setting PB Option.

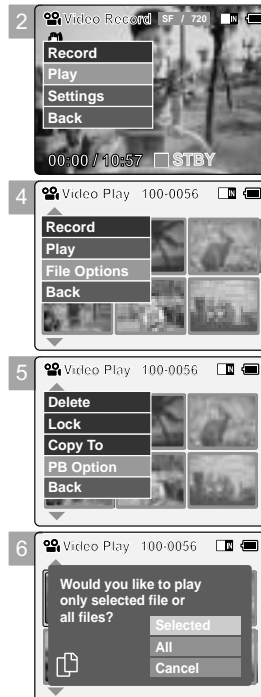

Note

* Press and hold the [Menu] button in Video Play, you can move to <File Options> directly.

Video Mode : Setting Various Functions

Setting the Video file Size

You can set the file size for video files. The number of stored files varies depending on the Memory Stick capacity and video file size.

1. Move [Mode Selector] down to turn on the CAM.
 - ◆ The Video Record screen appears.
 - ◆ You can select Video mode or Previous mode as the start-up mode in System Settings. (Refer to page 94)
2. Press the [Menu] button and move the [▲/▼] switch. Press the [OK] button after selecting <Settings>.
3. Move the [▲/▼] switch to select <Size> and press the [OK] button.
 - ◆ 720: Select 720 pixel.
 - ◆ 352: Select 352 pixel.
4. Move the [▲/▼] switch to select the video file size and press the [OK] button.
5. Press the [Menu] button to finish setting.
 - ◆ The icon of selected function is displayed.



Notes

- * If you select <Back> in the menu, the previous menu appears.
- * Press and hold the [Menu] button in Video Record, you can move to <Settings> directly.

Video Mode : Setting Various Functions

Setting the Video file Quality

You can set the quality for video files. The number of stored files varies depending on the Memory Stick capacity and video file quality.

1. Move [Mode Selector] down to turn on the CAM.
 - ◆ The Video Record screen appears.
 - ◆ You can select Video mode or Previous mode as the start-up mode in System Settings. (Refer to page 94)
2. Press the [Menu] button and move the [▲/▼] switch. Press the [OK] button after selecting <Settings>.
3. Move the [▲/▼] switch to select <Quality> and press the [OK] button.
 - ◆ SF(Super Fine): Select highest quality.
 - ◆ F(Fine): Select high quality.
 - ◆ N(Normal): Select normal quality.
4. Move the [▲/▼] switch to select the video file quality and press the [OK] button.
5. Press the [Menu] button to finish setting.
 - ◆ The icon of selected function is displayed.

Notes

- * If you select <Back> in the menu, the previous menu appears.
- * If you use the Memory Stick, you can select the size and quality of 720/Normal, 352/Fine and 352/Normal only.
- * Press and hold the [Menu] button in Video Record, you can move to <Settings> directly.

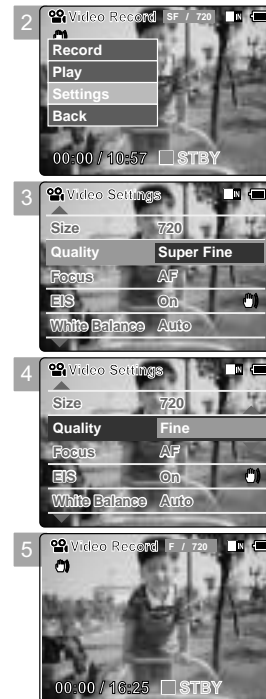

Video Mode : Setting Various Functions

Setting the Focus

You can set the focus depending on the subject or the environment. In most situations, you can record best using AF(Auto Focus).

1. **Move [Mode Selector] down to turn on the CAM.**
 - ◆ The Video Record screen appears.
 - ◆ You can select Video mode or Previous mode as the start-up mode in System Settings. (Refer to page 94)
2. **Press the [Menu] button and move the [▲/▼] switch. Press the [OK] button after selecting <Settings>.**
3. **Move the [▲/▼] switch to select <Focus> and press the [OK] button.**
 - ◆ **AF:** Set the focus automatically. When the CAM turns on, AF is selected in default.
 - ◆ **MF($\frac{M}{F}$):** Set the focus manually.
4. **Move the [▲/▼] switch to select desired setting and press the [OK] button.**
5. **Press the [Menu] button to finish setting.**
 - ◆ The icon of selected function is displayed.
 - ◆ If you select the AF, any icon is not displayed.

Manual Focus

Adjust the focus using [+]/[-] button to zoom in or out manually.

- ◆ When a picture contains objects that are both close and far away from the CAM.
- ◆ When a person is enveloped in fog or surrounded by snow.

Notes

- * If you select <Back> in the menu, the previous menu appears.
- * Press and hold the [Menu] button in Video Record, you can move to <Settings> directly.

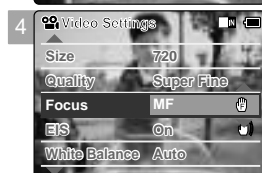
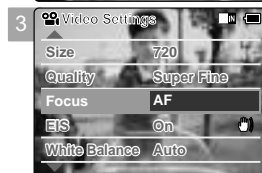

Video Mode : Setting Various Functions

Setting the EIS (Electronic Image Stabilizer)

The Electrical Image Stabilizer is a function that compensates for hand shake and other movements while recording.

EIS provides more stable video when:

- ◆ Recording with zooming
- ◆ Recording small objects
- ◆ Recording while walking or moving
- ◆ Recording through the window in the car

1. **Move [Mode Selector] down to turn on the CAM.**
 - ◆ The Video Record screen appears.
 - ◆ You can select Video mode or Previous mode as the start-up mode in System Settings. (Refer to page 94)
2. **Press the [Menu] button and move the [▲/▼] switch. Press the [OK] button after selecting <Settings>.**
3. **Move the [▲/▼] switch to select <EIS> and press the [OK] button.**
 - ◆ **On ($\frac{O}{N}$):** Set the EIS function.
 - ◆ **Off:** Cancel the EIS function.

4. **Move the [▲/▼] switch to select desired setting and press the [OK] button.**
5. **Press the [Menu] button to finish setting.**
 - ◆ The icon of selected function is displayed.

Notes

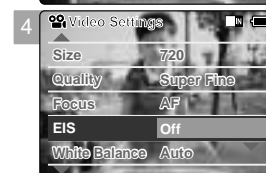
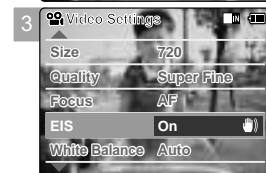

- * If you select <Back> in the menu, the previous menu appears.
- * Press and hold the [Menu] button in Video Record, you can move to <Settings> directly.



Video Mode : Setting Various Functions

Setting the White Balance

The colour balance may vary depending on the lighting conditions.
The White Balance is used to preserve natural colours under different lighting conditions.

1. **Move [Mode Selector] down to turn on the CAM.**
 - ◆ The Video Record screen appears.
 - ◆ You can select Video mode or Previous mode as the start-up mode in System Settings. (Refer to page 94)
2. **Press the [Menu] button and move the [▲/▼] switch.**
Press the [OK] button after selecting <Settings>.
3. **Move the [▲/▼] switch to select <White Balance> and press the [OK] button.**
 - ◆ **Auto:** Adjust the colour depending on the condition automatically.
 - ◆ **Hold**(): Record with first selected colour without adjusting colour.
 - ◆ **Outdoor**(): Record with the balanced light. (Natural light)
 - ◆ **Indoor**(): Record with the balanced light. (Glow lamp or light in the studio)
4. **Move the [▲/▼] switch to select desired setting and press the [OK] button.**
5. **Press the [Menu] button to finish setting.**
 - ◆ The icon of selected function is displayed.
 - ◆ If you select <Auto>, any icon is not displayed.

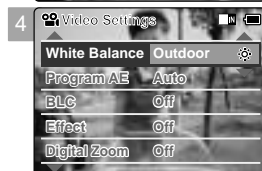





Notes

- * If you select <Back> in the menu, the previous menu appears.
- * Turn the Digital Zoom off for more accurate White Balance setting.
- * Press and hold the [Menu] button in Video Record, you can move to <Settings> directly.

Video Mode : Setting Various Functions

Setting the Program AE (Programmed Auto Exposure)

It allows you to adjust the aperture setting to suit different conditions.

1. **Move [Mode Selector] down to turn on the CAM.**
 - ◆ The Video Record screen appears.
 - ◆ You can select Video mode or Previous mode as the start-up mode in System Settings. (Refer to page 94)
2. **Press the [Menu] button and move the [▲/▼] switch.**
Press the [OK] button after selecting <Settings>.
3. **Move the [▲/▼] switch to select <Program AE> and press the [OK] button.**
 - ◆ **Auto:** Auto balance between the subject and background to get the best result. The shutter speed automatically varies from 1/60 to 1/250 per second depending on the scene.
 - ◆ **Sports**(): For recording fast-moving people or objects. It is suitable for sports events, recording outside in the car.
 - ◆ **Spotlight**(): Compensates for a subject that appears too bright under strong direct light such as spotlight. It is suitable for concert and school performance.
 - ◆ **Sand/Snow**(): Use when the light is very strong such as on the beach or in the snow.
 - ◆ **HS Shutter**(): Allows fast-moving images to be captured one frame at a time.
4. **Move the [▲/▼] switch to select desired setting and press the [OK] button.**
5. **Press the [Menu] button to finish setting.**
 - ◆ The icon of selected function is displayed.
 - ◆ If you select <Auto>, any icon is not displayed.

Notes

- * If you select <Back> in the menu, the previous menu appears.
- * Press and hold the [Menu] button in Video Record, you can move to <Settings> directly.

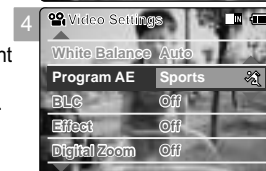
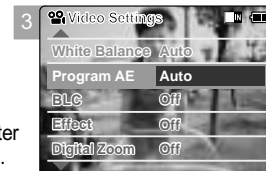

Video Mode : Setting Various Functions

Setting the BLC (Backlight Compensation)

The Backlight Compensation function helps to make the subject brighter when the subject is in front of a window or the subject is too dark to distinguish. You can use this function when using your the CAM in the bright background and snowy background.

1. Move [Mode Selector] down to turn on the CAM.

- ◆ The Video Record screen appears.
- ◆ You can select Video mode or Previous mode as the start-up mode in System Settings. (Refer to page 94)

2. Press the [Menu] button and move the [▲/▼] switch.

Press the [OK] button after selecting <Settings>.

3. Move the [▲/▼] switch to select <BLC> and press the [OK] button.

- ◆ On(BLC): Set the BLC function.
- ◆ Off: Cancel the BLC function.

4. Move the [▲/▼] switch to select desired setting and press the [OK] button.

5. Press the [Menu] button to finish setting.

- ◆ <BLC> is displayed.

Notes

- * If you select <Back> in the menu, the previous menu appears.
- * Press and hold the [Menu] button in Video Record, you can move to <Settings> directly.

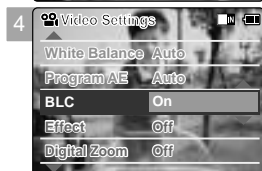

Video Mode : Setting Various Functions

Setting the Effect

You can create professional looking effect on your video file.

1. Move [Mode Selector] down to turn on the CAM.

- ◆ The Video Record screen appears.
- ◆ You can select Video mode or Previous mode as the start-up mode in System Settings. (Refer to page 94)

2. Press the [Menu] button and move the [▲/▼] switch.

Press the [OK] button after selecting <Settings>.

3. Move the [▲/▼] switch to select <Effect> and press the [OK] button.

- ◆ Off: Cancel the <Effect>.
- ◆ Art: Artistic effects on your video file.
- ◆ Mosaic: A mosaic overlay appears on your video file.
- ◆ Sepia: The picture is displayed in sepia colour similar to that of an old photograph.
- ◆ Negative: Reverses the colours, creating the look of a negative.
- ◆ Mirror: This mode cuts the picture in half using a Mirror effect.
- ◆ B&W: Changes the images into Black and White.
- ◆ Emboss: Embossing effects on your video file.

4. Move the [▲/▼] switch to select desired setting and press the [OK] button.

5. Press the [Menu] button to finish setting.

- ◆ The letters of selected function is displayed.

Notes

- * If you select <Back> in the menu, the previous menu appears.
- * Press and hold the [Menu] button in Video Record, you can move to <Settings> directly.

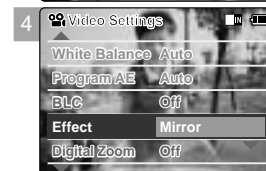
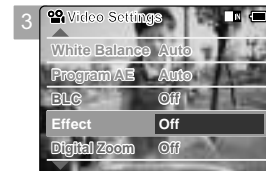

Video Mode : Setting Various Functions

Setting the Digital Zoom

You can magnify optical zoom(x10) digitally. The Digital Zoom processes data to enlarge the centre portion of the image to fill the frame may produce a less detailed and slightly grainy picture.

1. **Move [Mode Selector] down to turn on the CAM.**
 - ◆ The Video Record screen appears.
 - ◆ You can select Video mode or Previous mode as the start-up mode in System Settings. (Refer to page 94)

2. **Press the [Menu] button and move the [▲/▼] switch. Press the [OK] button after selecting <Settings>.**

3. **Move the [▲/▼] switch to select <Digital Zoom> and press the [OK] button.**
 - ◆ **On:** Set the Digital Zoom. (X100)
 - ◆ **Off:** Cancel the Digital Zoom.

4. **Move the [▲/▼] switch to select desired setting and press the [OK] button.**

5. **Press the [Menu] button to finish setting.**
 - ◆ 4 zoom indicators increase after setting the Digital Zoom.

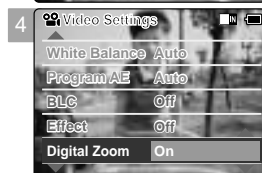
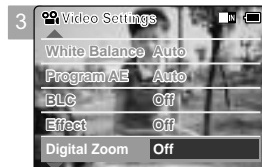

Notes

- * If you select <Back> in the menu, the previous menu appears.
- * Press and hold the [Menu] button in Video Record, you can move to <Settings> directly.

2 Photo Mode

Capturing	54
Capturing Images	54
Zooming In and Out	55
Viewing	56
Viewing Photo files on the LCD Monitor	56
Selecting File Options	57
Deleting Photo files	57
Locking Photo files	58
Setting DPOF Function	59
Copying Photo files	60
Setting Various Functions	61
Setting the Photo file Size	61
Setting the Light	62
Setting the Focus	63
Setting the EIS	64
Setting the White Balance	65
Setting the Program AE	66
Setting the BLC	67

Photo Mode : Capturing

Capturing Images

You can take photo as well as record video files.

1. Move [Mode Selector] down to turn on the CAM and move it down again.

◆ The Mode Selection screen appears.

2. Move the [▲/▼] switch to select *Photo* mode and press the [OK] button.

◆ The CAM is ready for taking pictures.

◆ [📷] indicator is displayed on LCD.

3. Press [Record/Stop] button to take pictures.

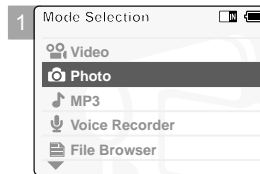

Note

* If the battery is low and the icon blinks, the light is not operated and light icon is set to off state.

Photo Mode : Capturing

Zooming In and Out

Zooming technique lets you change the size of the subject captured in a scene.

1. Move [Mode Selector] down to turn on the CAM and move it down again.

◆ The Mode Selection screen appears.

2. Move the [▲/▼] switch to select *Photo* mode and press the [OK] button.

◆ To take pictures, press the [Record/Stop] button again.

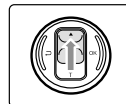

Move the [▲/▼] switch up to zoom out.

- The subject appears farther away when you zoom out.



Move the [▲/▼] switch down to zoom in.

- The subject appears closer when you zoom in.

Zoom Out



Zoom In



Note

* Frequent use of zooming may result in higher battery power consumption.

Photo Mode : Viewing

Viewing Photo files on the LCD Monitor

It is handy and practical to view pictures using the LCD monitor almost anywhere such as in a car, indoors or outdoors.

1. Move [Mode Selector] down to turn on the CAM and move it down again.
◆ The Mode Selection screen appears.
2. Move the [▲/▼] switch to select *Photo* mode and press the [OK] button.
◆ The Photo Capture screen appears.
3. Press the [Menu] button and move the [▲/▼] switch.
Press the [OK] button after selecting <View>.
4. Move the [▲/▼] switch to find the photo you want to view.
◆ Each time you move the [▲/▼] switch, the frame moves horizontally.
◆ Each time you press the [+]/[-] button, a page(6 frame) moves.
5. Press [OK] button to view the photo you want.
◆ The full screen displays.

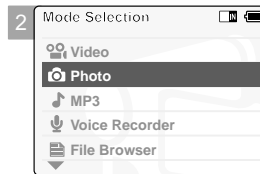

Note

* Display time may vary depending on the picture size.

Photo Mode : Selecting File Options

Deleting Photo files

You can delete photo files in <File Options>.

1. Move [Mode Selector] down to turn on the CAM and move it down again.
◆ The Mode Selection screen appears.
2. Move the [▲/▼] switch to select [Photo] mode and press the [OK] button.
◆ The Photo Capture screen appears.
3. Press the [Menu] button and move the [▲/▼] switch.
Press the [OK] button after selecting <View>.
4. Move the [▲/▼] switch to select the photo file you want to delete.
5. Press the [Menu] button to select <File Options> and press the [OK] button.
◆ You can select <File Options> only in <View>.
6. Move the [▲/▼] switch to select <Delete> and press the [OK] button.
7. Move the [▲/▼] switch to select the followings and press the [OK] button.
◆ **Selected:** The selected photo file is deleted.
◆ **All:** All photo files are deleted.
◆ **Cancel:** Cancel deleting photo files.

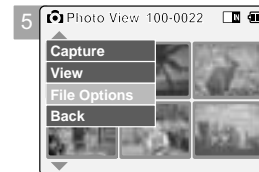

Note

* Press and hold the [Menu] button in Photo View, you can move to <File Options> directly.

Photo Mode : Selecting File Options

Locking Photo files

You can lock the important photo file not to be deleted.

1. Move [Mode Selector] down to turn on the CAM and move it down again.
 - ◆ The Mode Selection screen appears.
2. Move the [▲/▼] switch to select *Photo* mode and press the [OK] button.
 - ◆ The Photo Capture screen appears.
3. Press the [Menu] button and move the [▲/▼] switch. Press the [OK] button after selecting <View>.
4. Move the [▲/▼] switch to select the photo file you want to lock.
5. Press the [Menu] button to select <File Options> and press the [OK] button.
 - ◆ You can select <File Options> only in <View>.
6. Move the [▲/▼] switch to select <Lock> and press the [OK] button.
7. Move the [▲/▼] switch to select the followings and press the [OK] button.
 - ◆ **Selected:** The selected photo file is locked.
 - ◆ **All:** All photo files are locked.
 - ◆ **Cancel:** Cancel locking photo files.

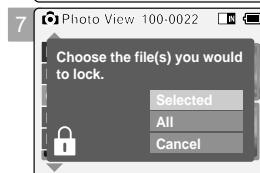
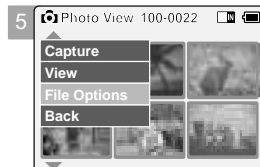

Notes

- * Press and hold the [Menu] button in Photo View, you can move to <File Options> directly.
- * The <🔒> icon is displayed on the locked file.

Photo Mode : Selecting File Options

Setting DPOF (Digital Print Order Format) Function

1. Move [Mode Selector] down to turn on the CAM and move it down again.
 - ◆ The Mode Selection screen appears.
2. Move the [▲/▼] switch to select *Photo* mode and press the [OK] button.
 - ◆ The Photo Capture screen appears.
3. Press the [Menu] button and move the [▲/▼] switch. Press the [OK] button after selecting <View>.
4. Move the [▲/▼] switch to select the photo file you want to print.
5. Press the [Menu] button to select <File Options> and press the [OK] button.
6. Move the [▲/▼] switch to select <DPOF> and press the [OK] button.
 - ◆ You can select <DPOF> only when you've selected storage type 'External'. Refer to page 32.
7. Move the [▲/▼] switch to select copies you want to print.

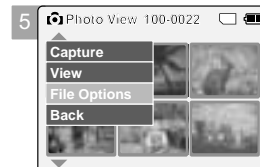

Notes

- * Press and hold the [Menu] button in Photo View, you can move to <File Options> directly.
- * Refer to page 116 for further details about printing DPOF files.
- * You can set copies for DPOF print up to 30.

Photo Mode : Selecting File Options

Copying Photo files

You can copy photo files to the internal or external memory.

1. Move [Mode Selector] down to turn on the CAM and move it down again.
◆ The Mode Selection screen appears.
2. Move the [▲/▼] switch to select *Photo* mode and press the [OK] button.
◆ The Photo Capture screen appears.
3. Press the [Menu] button and move the [▲/▼] switch.
Press the [OK] button after selecting <View>.
4. Move the [▲/▼] switch to select the photo file you want to copy.
5. Press the [Menu] button to select <File Options> and press the [OK] button.
◆ You can select <File Options> only in <View>.
6. Move the [▲/▼] switch to select <Copy To> and press the [OK] button.
◆ If you selected the Storage type 'External', the file is copied to 'Internal'.
7. Move the [▲/▼] switch to select the followings and press the [OK] button.
◆ **Selected:** Copy the selected photo file.
◆ **All:** Copy all photo files.
◆ **Cancel:** Cancel copying photo files.

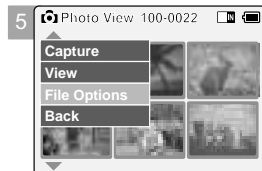

Note

* Press and hold the [Menu] button in Photo View, you can move to <File Options> directly.

Photo Mode : Setting Various Functions

Setting the Photo file Size

You can set the photo files size. The number of stored files varies depending on the Memory Stick capacity, photo files size.

1. Move [Mode Selector] down to turn on the CAM and move it down again.
◆ The Mode Selection screen appears.
2. Move the [▲/▼] switch to select *Photo* mode and press the [OK] button.
◆ The Photo Capture screen appears.
3. Press the [Menu] button and move the [▲/▼] switch.
Press the [OK] button after selecting <Settings>.
4. Move the [▲/▼] switch to select <Size> and press the [OK] button.
◆ You can select 800x600 or 640x480 size.
5. Move the [▲/▼] switch to select desired setting and press the [OK] button.
6. Press the [Menu] button to finish setting.

Notes

- * If you select <Back> in the menu, the previous menu appears.
- * Press and hold the [Menu] button in Photo View, you can move to <File Options> directly.

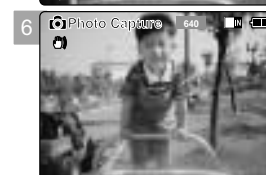
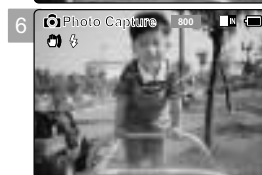
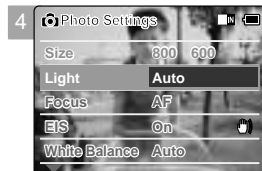

Photo Mode : Setting Various Functions

Setting the Light

The Light only works in Photo Mode and allows the user to take photographs in dark places such as during the night, shaded or dark areas and indoors.

1. Move [Mode Selector] down to turn on the CAM and move it down again.
◆ The Mode Selection screen appears.
2. Move the [▲/▼] switch to select *Photo* mode and press the [OK] button.
◆ The Photo Capture screen appears.
3. Press the [Menu] button and move the [▲/▼] switch.
Press the [OK] button after selecting <Settings>.
4. Move the [▲/▼] switch to select <Light> and press the [OK] button.
5. Move the [▲/▼] switch to select desired setting and press the [OK] button.
◆ **Auto**: Set the light automatically.
◆ **On** (🔦): Turn on the light.
◆ **Off** (🚫): Turn off the light.
6. Press the [Menu] button to finish setting.
◆ The icon of selected function is displayed.



Notes

- * If you select <Back> in the menu, the previous menu appears.
- * Press and hold the [Menu] button in Photo View, you can move to <File Options> directly.

Photo Mode: Setting Various Functions

Setting the Focus

You can set the focus depending on the subject or the environment. In most situations, you can record the best photo using AF(Auto Focus).

1. Move [Mode Selector] down to turn on the CAM and move it down again.
◆ The Mode Selection screen appears.
2. Move the [▲/▼] switch to select *Photo* mode and press the [OK] button.
◆ The Photo Capture screen appears.
3. Press the [Menu] button and move the [▲/▼] switch.
Press the [OK] button after selecting <Settings>.
4. Move the [▲/▼] switch to select <Focus> and press the [OK] button.
◆ **AF**: Set the focus automatically. When the CAM turns on, AF is selected in default.
◆ **MF** (Mⁿ): Set the focus manually.
5. Move the [▲/▼] switch to select desired setting and press the [OK] button.
6. Press the [Menu] button to finish setting.
◆ The icon of selected function is displayed.
◆ If you select the AF, no icon is displayed.

Manual Focus

Adjust the focus using [+]/[-] button to zoom in or out manually.

- ◆ When a picture has subjects close and distant to the CAM
- ◆ When a person is enveloped in fog or surrounded by snow

Notes

- * If you select <Back> in the menu, the previous menu appears.
- * Press and hold the [Menu] button in Photo View, you can move to <File Options> directly.



Photo Mode : Setting Various Functions

Setting the EIS (Electronic Image Stabilizer)

The Electrical Image Stabilizer is a function that compensates for hand shake and other movements while taking pictures. Refer to page 46 for further details.

1. Move [Mode Selector] down to turn on the CAM and move it down again.
 - ◆ The Mode Selection screen appears.
2. Move the [▲/▼] switch to select *Photo* mode and press the [OK] button.
 - ◆ The Photo Capture screen appears.
3. Press the [Menu] button and move the [▲/▼] switch. Press the [OK] button after selecting <Settings>.
4. Move the [▲/▼] switch to select <EIS> and press the [OK] button.
 - ◆ On (👉): Set the EIS function.
 - ◆ Off: Cancel the EIS function.
5. Move the [▲/▼] switch to select desired setting and press the [OK] button.
6. Press the [Menu] button to finish setting.
 - ◆ The icon of selected function is displayed.



Notes

- * If you select <Back> in the menu, the previous menu appears.
- * Press and hold the [Menu] button in Photo View, you can move to <File Options> directly.

Photo Mode : Setting Various Functions

Setting the White Balance

The colour balance may vary depending on the lighting conditions. The White Balance is used to preserve natural colours under different lighting conditions.

1. Move [Mode Selector] down to turn on the CAM and move it down again.
 - ◆ The Mode Selection screen appears.
2. Move the [▲/▼] switch to select *Photo* mode and press the [OK] button.
 - ◆ The Photo Capture screen appears.
3. Press the [Menu] button and move the [▲/▼] switch. Press the [OK] button after selecting <Settings>.
4. Move the [▲/▼] switch to select <White Balance> and press the [OK] button.
 - ◆ Auto: Adjust the colour depending on the condition automatically.
 - ◆ Hold (👉): Record with first selected colour without adjusting colour.
 - ◆ Outdoor (☀️): Record with the balanced light. (Natural light)
 - ◆ Indoor (💡): Record with the balanced light. (Glow lamp, light in the studio or video light)
5. Move the [▲/▼] switch to select desired setting and press the [OK] button.
6. Press the [Menu] button to finish setting.
 - ◆ The icon of selected function is displayed.
 - ◆ If you select <Auto>, no icon is displayed.

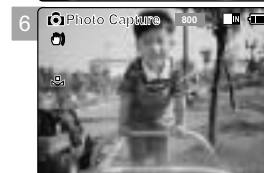

Notes

- * If you select <Back> in the menu, the previous menu appears.
- * Press and hold the [Menu] button in Photo View, you can move to <File Options> directly.

Photo Mode : Setting Various Functions

Setting the Program AE (Programmed Auto Exposure)

It allows you to adjust the aperture setting to suit different conditions.

1. Move [Mode Selector] down to turn on the CAM and move it down again.
 - ◆ The Mode Selection screen appears.
2. Move the [▲/▼] switch to select *Photo* mode and press the [OK] button.
 - ◆ The Photo Capture screen appears.
3. Press the [Menu] button and move the [▲/▼] switch. Press the [OK] button after selecting <Settings>.
4. Move the [▲/▼] switch to select <Program AE> and press the [OK] button.
 - ◆ **Auto**: Auto balance between the subject and background to get the best result. The shutter speed automatically varies from 1/60 to 1/250 per second depending on the scene.
 - ◆ **Sports** (🏊): For fast-moving people or objects. It is suitable for sports events or when you are outside in the car.
 - ◆ **Spotlight** (🔦): Compensates for a subject that appears too bright under strong direct light such as spotlight. It is suitable for concert and school performance.
 - ◆ **Sand/Snow** (🌨): Use when the light is very strong such as on the beach or in the snow.
 - ◆ **HS Shutter** (📷): Allows fast-moving images to be captured one frame at a time.
5. Move the [▲/▼] switch to select desired setting and press the [OK] button.
6. Press the [Menu] button to finish setting.
 - ◆ The icon of selected function is displayed.
 - ◆ If you select <Auto>, any icon is not displayed.

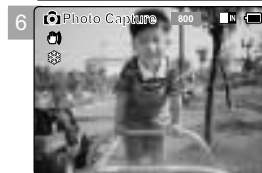

Notes

- * If you select <Back> in the menu, the previous menu appears.
- * Press and hold the [Menu] button in Photo View, you can move to <File Options> directly.

Photo Mode : Setting Various Functions

Setting the BLC (Backlight Compensation)

The Backlight Compensation function helps to make the subject brighter when the subject is in front of a window or the subject is too dark to distinguish. You can use this function when using the CAM in the bright backgrounds including snow scenes.

1. Move [Mode Selector] down to turn on the CAM and move it down again.
 - ◆ The Mode Selection screen appears.
2. Move the [▲/▼] switch to select *Photo* mode and press the [OK] button.
 - ◆ The Photo Capture screen appears.
3. Press the [Menu] button and move the [▲/▼] switch. Press the [OK] button after selecting <Settings>.
4. Move the [▲/▼] switch to select <BLC> and press the [OK] button.
 - ◆ **On**(BLC): Set the BLC function.
 - ◆ **Off**: Cancel the BLC function.
5. Move the [▲/▼] switch to select desired setting and press the [OK] button.
6. Press the [Menu] button to finish setting.
 - ◆ <BLC > is displayed.



Notes

- * If you select <Back> in the menu, the previous menu appears.
- * Press and hold the [Menu] button in Photo View, you can move to <File Options> directly.

MP3 Mode : Storing Music in the CAM

Copying Music files to the CAM

You can transfer music files from your PC to the internal memory, Memory Stick or Memory Stick Pro. For copying music files, the CAM must be connected to your PC with the USB cable. You don't have to connect the CAM to your PC when you transfer music files to the Memory Stick directly.

1. **Connect the CAM to a PC with the USB cable.**
 - ◆ Your computer recognises this device and the symbol for removable drive will appear in 'My Computer'.
2. **Double-click the new removable drive to open.**
3. **Select the MP3 folder and double-click to enter.**
4. **Copy the MP3 file you want from PC to the CAM.**
 - ◆ Refer to the folder structure on page 29 for copying MP3 files.

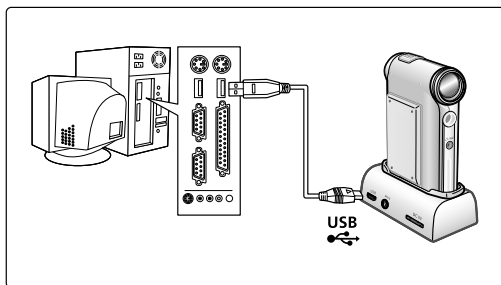

Disconnecting USB Connection

After completing the data transfer, you must disconnect the cable in the following way.

1. Select the removable disk icon and click the right mouse button to select 'Safely Remove Hardware'.
2. Select 'Stop' and disconnect the USB cable when the pop-up screen disappears.

Notes

- * The way of transferring, playing with the Memory Stick is same as that of internal memory.
- * Refer to page 113 for installing USB Driver for Windows98SE.

MP3 Mode : Playing

Playing Music files

You can hear the music copied from your PC directly or with the Memory Stick.

1. **Connect the earphones to the CAM.**
 - ◆ You can also hear the music from the Built-in speaker without the earphones.
2. **Move [Mode Selector] down to turn on the CAM and move it down again.**
 - ◆ The Mode Selection screen appears.
3. **Move the [▲/▼] switch to select MP3 mode and press the [OK] button.**
4. **Move the [▲/▼] switch to find the music you want to hear and press the [OK] button.**
 - ◆ The selected music is played.
5. **Press the [OK] button again to stop hearing music.**
 - ◆ Each time you press the [OK] button, play or pause is selected repeatedly.

The use of [▲/▼] switch

- * **Press the [▲] switch**
First 2 seconds after start playing - the previous file appears.
2 seconds after start playing - the first scene of the file appears.
- * **Press the [▼] switch**
The next file appears.

Notes

- * '----' is displayed depending on the title of MP3 file.
- * If you lock the MP3 hold switch, you cannot use the button except the Power switch and volume +/- button. The MP3 hold switch operates only in the MP3 mode.

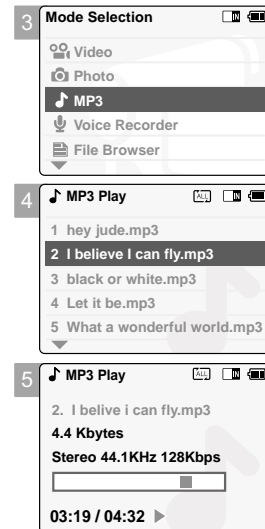

MP3 Mode : Selecting Play Options

Setting Repeat Play

You can play the only one or all music repeatedly.

- Connect the earphones to the CAM.**
 - You can also hear the music from the Built-in speaker without the earphones.
- Move [Mode Selector] down to turn on the CAM and move it down again.**
 - The Mode Selection screen appears.
- Move the [▲/▼] switch to select MP3 mode and press the [OK] button.**
 - Press the [Menu] button when the music list appears.
- Move the [▲/▼] switch to select <Play Options> and press the [OK] button.**
- Move the [▲/▼] switch to select <Repeat> and press the [OK] button.**
 - All:** All files are repeated.
 - Off:** Cancel the Repeat Play function.
 - One:** One file is repeated.
- Move the [▲/▼] switch to select desired setting and press the [OK] button.**
- Press the [Menu] button to finish setting.**

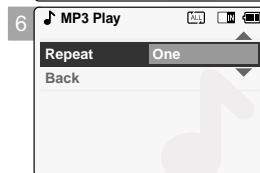
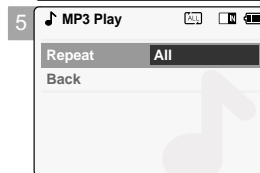
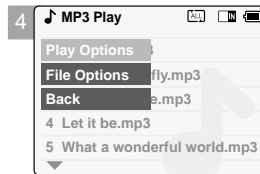
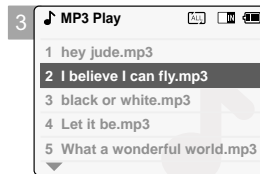

Note

※ If you select <Back> in the menu, the previous menu appears.

MP3 Mode : Selecting File Options

Deleting Music files

You can delete the music file you want.

- Move [Mode Selector] down to turn on the CAM and move it down again.**
 - The Mode Selection screen appears.
- Move the [▲/▼] switch to select MP3 mode and press the [OK] button.**
 - Press the [Menu] button when the music list appears.
- Move the [▲/▼] switch to select <File Options> and press the [OK] button.**
- Move the [▲/▼] switch to select <Delete> and press the [OK] button.**
- Move the [▲/▼] switch to select the followings and press the [OK] button.**
 - Selected:** The selected music file is deleted.
 - All:** All music files are deleted.
 - Cancel:** Cancel deleting music files.

Note

※ If you select <Back> in the menu, the previous menu appears.

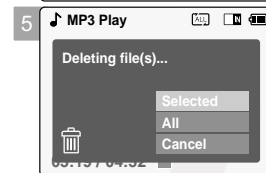
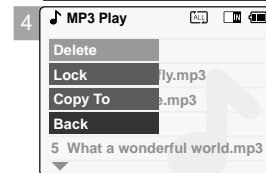
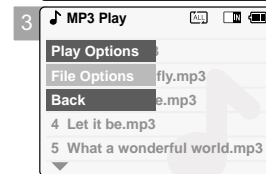
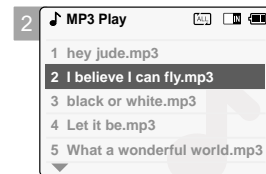

MP3 Mode : Selecting File Options

Locking Music files

You can lock the important music file not to be deleted.

1. Move [Mode Selector] down to turn on the CAM and move it down again.
 - ◆ The Mode Selection screen appears.
2. Move the [▲/▼] switch to select MP3 mode and press the [OK] button.
 - ◆ Press the [Menu] button when the music list appears.
3. Move the [▲/▼] switch to select <File Options> and press the [OK] button.
4. Move the [▲/▼] switch to select <Lock> and press the [OK] button.
5. Move the [▲/▼] switch to select the followings and press the [OK] button.
 - ◆ **Selected:** The selected music file is locked.
 - ◆ **All:** All music files are locked.
 - ◆ **Cancel:** Cancel locking music files.

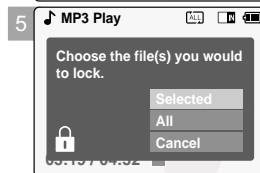
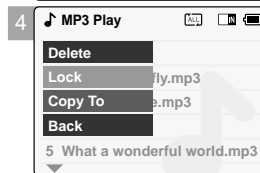
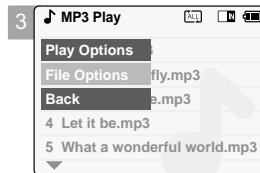
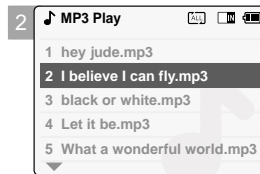

Notes

- * If you select <Back> in the menu, the previous menu appears.
- * The <🔒> icon is displayed on the locked file.

MP3 Mode : Selecting File Options

Copying Music files

You can copy the music file to the internal or external memory.

1. Move [Mode Selector] down to turn on the CAM and move it down again.
 - ◆ The Mode Selection screen appears.
2. Move the [▲/▼] switch to select MP3 mode and press the [OK] button.
 - ◆ Press the [Menu] button when the music list appears.
3. Move the [▲/▼] switch to select <File Options> and press the [OK] button.
4. Move the [▲/▼] switch to select <Copy To> and press the [OK] button.
 - ◆ If you selected the Storage type 'External', the file is copied to 'Internal'.
5. Move the [▲/▼] switch to select the followings and press the [OK] button.
 - ◆ **Selected:** Copy the selected music file.
 - ◆ **All:** Copy all music files.
 - ◆ **Cancel:** Cancel copying music files.

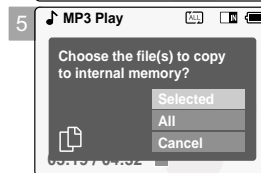
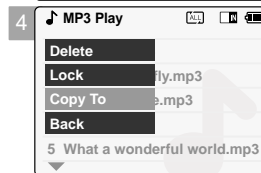
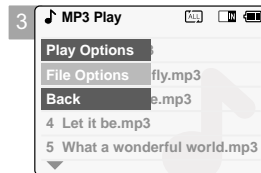
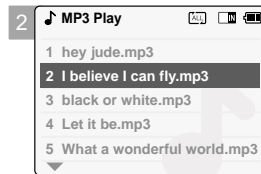

Note

- * If you set Hold function with the MP3 Hold switch, you can't delete, lock or copy music files. You can only use Power switch and volume [+]/[-] buttons.

Voice Recorder Mode : Recording

Recording Voice

You can record voice using the built-in microphone in the CAM.

1. Move [Mode Selector] down to turn on the CAM and move it down again.
◆ The Mode Selection screen appears.
2. Move the [▲/▼] switch to select *Voice Recorder* mode and press the [OK] button.
3. Press the [Record/Stop] button to record voice.
◆ The elapsed time and <● REC> is displayed. It starts recording.
4. Press the [Record/Stop] button to stop recording voice.
◆ <■ STBY> is displayed and it stops recording.

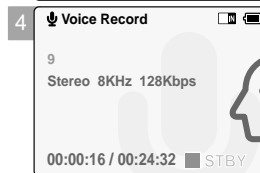
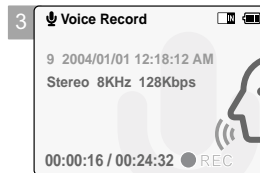
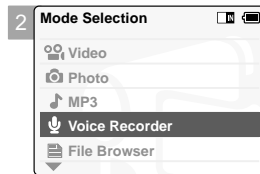

Voice Recorder Mode : Playing

Playing Voice files

You can hear the voice file connecting earphones.

1. Move [Mode Selector] down to turn on the CAM and move it down again.
◆ The Mode Selection screen appears.
2. Move the [▲/▼] switch to select *Voice Recorder* mode and press the [OK] button.
3. Press the [Menu] button when the Voice Record screen appears.
4. Move the [▲/▼] switch to select <Play> and press the [OK] button.
5. Move the [▲/▼] switch to select the file you want to play.
6. Press the [OK] button to play the recorded voice.
◆ Press the [OK] button to pause playing.

The button and switch you use when playing the recording

Play/Pause [OK] button: Play or pause the voice file

Rewind [▲] switch: Rewind the voice file(Press it for 2 seconds)/Move to previous file

Fast Forward [▼] switch: Wind the voice file forward(Press it for 2 seconds)/Move to next file

Note

* Press the [Back] button while recording standby status to view the file list.

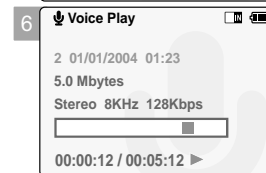
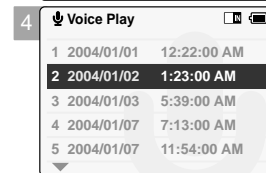
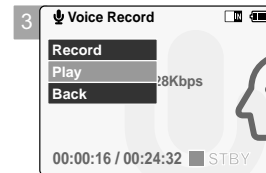
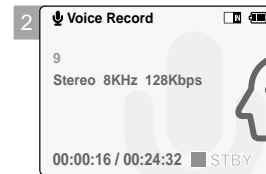

Voice Recorder Mode : Selecting File Options

Deleting Voice files

You can delete voice files you want.

1. Move [Mode Selector] down to turn on the CAM and move it down again.
◆ The Mode Selection screen appears.
2. Move the [▲/▼] switch to select *Voice Recorder* mode and press the [OK] button.
3. Press the [Menu] button when the Voice Record Screen appears.
4. Move the [▲/▼] switch to select <Play> and press the [OK] button.
5. Press the [Menu] button to select <File Options> and press the [OK] button.
◆ You can select <File Options> only in <Play>.
6. Move the [▲/▼] switch to select <Delete> and press the [OK] button.
7. Move the [▲/▼] switch to select the followings and press the [OK] button.
◆ **Selected:** The selected voice file is deleted.
◆ **All:** All voice files are deleted.
◆ **Cancel:** Cancel deleting voice files.

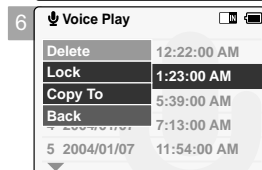
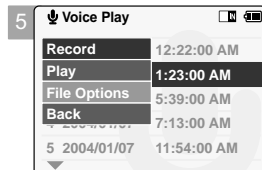
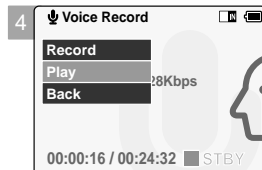

Note

* If you select <Back> in the menu, the previous menu appears.

Voice Recorder Mode : Selecting File Options

Locking Voice files

You can lock the important voice file not to be deleted.

1. Move [Mode Selector] down to turn on the CAM and move it down again.
◆ The Mode Selection screen appears.
2. Move the [▲/▼] switch to select *Voice Recorder* mode and press the [OK] button.
3. Press the [Menu] button when the Voice Record screen appears.
4. Move the [▲/▼] switch to select <Play> and press the [OK] button.
5. Press the [Menu] button to select <File Options> and press the [OK] button.
◆ You can select <File Options> only in <Play>.
6. Move the [▲/▼] switch to select <Lock> and press the [OK] button.
7. Move the [▲/▼] switch to select the followings and press the [OK] button.
◆ **Selected:** The selected voice file is locked.
◆ **All:** All voice files are locked.
◆ **Cancel:** Cancel locking voice files.

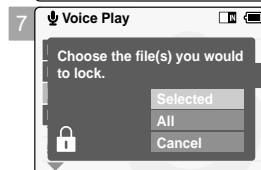
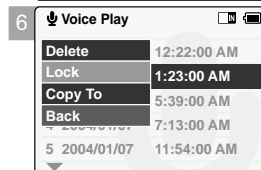
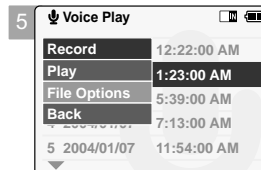
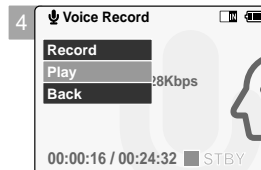

Notes

- * If you select <Back> in the menu, the previous menu appears.
- * The <🔒> icon is displayed on the locked file.

Voice Recorder Mode : Selecting File Options

Copying Voice files

You can copy the voice file to the internal or external memory.

1. Move [Mode Selector] down to turn on the CAM and move it down again.
◆ The Mode Selection screen appears.
2. Move the [▲/▼] switch to select *Voice Recorder* mode and press the [OK] button.
3. Press the [Menu] button when the Voice Record screen appears.
4. Move the [▲/▼] switch to select <Play> and press the [OK] button.
5. Press the [Menu] button to select <File Options> and press the [OK] button.
◆ You can select <File Options> only in <Play>.
6. Move the [▲/▼] switch to select <Copy To> and press the [OK] button.
◆ If you selected the Storage type 'External', the file is copied to 'Internal'.
7. Move the [▲/▼] switch to select the followings and press the [OK] button.
◆ **Selected:** Copy the selected voice file.
◆ **All:** Copy all voice files.
◆ **Cancel:** Cancel copying voice files.

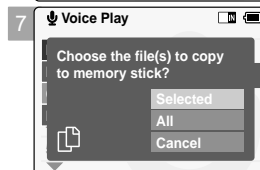
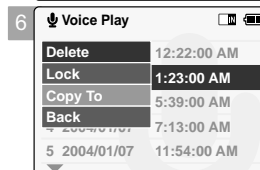
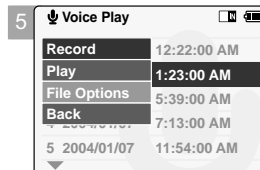
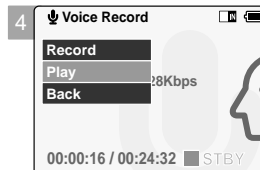

Note

* If you select <Back> in the menu, the previous menu appears.

Using File Browser

Deleting Files or Folders

You can delete the file(AVI, MP3, JPEG, WAV) or folders you recorded.

1. Move the [Mode Selector] down to turn on the CAM and press it again.
◆ The Mode Selection screen appears.
2. Move the [▲/▼] switch to select *File Browser* and press the [OK] button.
3. Move the [▲/▼] switch to select the folder to find the file you want to delete. Press the [OK] button.
◆ Press the [Menu] button if you want to delete the selected folder.
◆ Perform these steps repeatedly until the file you want to delete appears.
4. Press the [Menu] button and move the [▲/▼] switch. Press the [OK] button after selecting <Delete>.
5. Move the [▲/▼] button to select the setting you want. Press the [OK] button.
◆ **Selected:** The selected file is deleted.
◆ **All:** All files are deleted.
◆ **Cancel:** Cancel deleting files.

Note

* If you select <Back> in the menu, the previous menu appears.

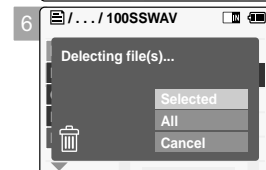
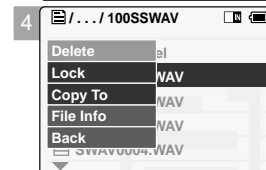
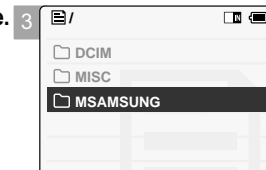
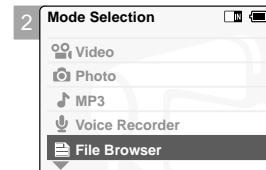

Using File Browser

Locking Files

You can lock the important video files or photo files not to be deleted.

1. Move the [Mode Selector] down to turn on the CAM and press it again.
◆ The Mode Selection screen appears.
2. Move the [▲/▼] switch to select *File Browser* and press the [OK] button.
3. Move the [▲/▼] switch to select the file you want to lock.
Press the [OK] button.
◆ Perform these steps repeatedly until the file you want to lock appears.
4. Press the [Menu] button and move the [▲/▼] switch.
Press the [OK] button after selecting <Lock>.
5. Move the [▲/▼] button to select the followings. Press the [OK] button.
◆ **Selected:** The selected file is locked.
◆ **All:** All files are locked.
◆ **Cancel:** Cancel locking files.

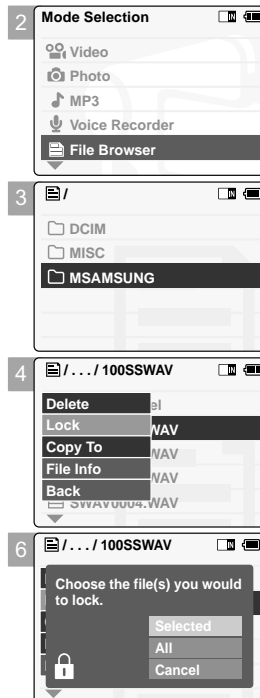

Notes

- * If you select <Back> in the menu, the previous menu appears.
- * You can't lock folders.
- * The <🔒> icon is displayed on the locked file.

Using File Browser

Copying Files or Folders

You can copy the file or folder to the internal or external memory.

1. Move the [Mode Selector] down to turn on the CAM and press it again.
◆ The Mode Selection screen appears.
2. Move the [▲/▼] switch to select *File Browser* and press the [OK] button.
3. Move the [▲/▼] switch to select the folder to find the file you want to copy.
Press the [OK] button.
◆ Press the [Menu] button if you want to copy the selected folder.
◆ Perform these steps repeatedly until the file you want to copy appears.
4. Press the [Menu] button and move the [▲/▼] switch.
Press the [OK] button after selecting <Copy To>.
◆ If you selected the Storage type 'External', the file is copied to 'Internal'.
5. Move the [▲/▼] button to select the followings. Press the [OK] button.
◆ **Selected:** Copy the selected file.
◆ **All:** Copy all files.
◆ **Cancel:** Cancel copying files.

Note

- * If you select <Back> in the menu, the previous menu appears.

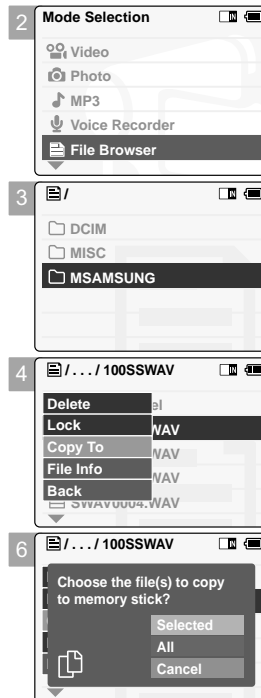

Using File Browser

Viewing File Information

You can see the file name, format, size and date.

1. Move the [Mode Selector] down to turn on the CAM and press it again.
◆ The Mode Selection screen appears.
2. Move the [▲/▼] switch to select *File Browser* and press the [OK] button.
3. Move the [▲/▼] switch to select the file you want to see its file information. Press the [OK] button.
◆ Perform these steps repeatedly until the file you want to see its file information appears.
4. Press the [Menu] button and move the [▲/▼] switch. Press the [OK] button after selecting <File Info>.
◆ The screen with file name, format, size and date appears.
5. Press the [OK] button to finish viewing file information.
◆ If you select <Close> in the screen, the screen disappears.

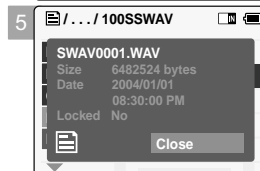
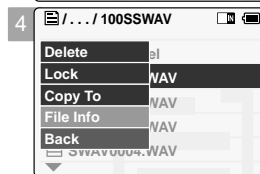
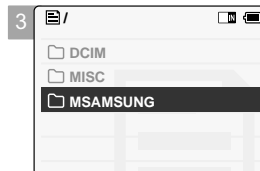
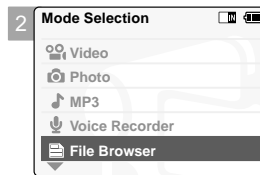

4 Setting the CAM

Adjusting the LCD Monitor	85
Adjusting the LCD Brightness	86
Adjusting the LCD Colour	87
Adjusting Date/Time	88
Setting Time	88
Setting Date	89
Setting Date Format	90
Setting Time Format	91
Setting the System	92
Setting the Auto Shut off	92
Setting the Demo Function	93
Setting Start-up Mode	94
Setting the File No. Function	95
Setting the Beep Sound	96
Viewing Version Information	97
Setting Memory	98
Selecting the Storage Type	98
Formatting the Memory	99
Viewing Memory Space	100
Using USB Mode	101
Storing Files to the External Memory	101
System Environment	102
Using PC Cam	103
Connecting the CAM to a Printer	104

Setting the CAM : Adjusting the LCD Monitor

Adjusting the LCD Brightness

You can adjust the brightness of the LCD monitor to compensate for ambient lighting conditions.

1. Move [Mode Selector] down to turn on the CAM and move it down again.
◆ The Mode Selection screen appears.
2. Move the [▲/▼] switch to select *System Settings* and press the [OK] button.
3. Move the [▲/▼] switch to select <Display> and press the [OK] button.
4. Move the [▲/▼] switch to select <LCD Brightness> and press the [OK] button.
◆ You can adjust the LCD Brightness from 0% to 100%.
5. Move the [▲/▼] switch to select the brightness you want.
6. Press the [Back] button to finish setting.

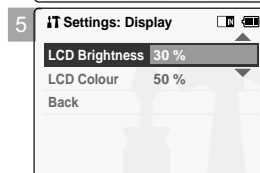
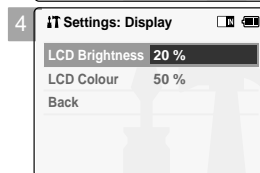
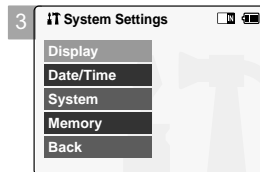
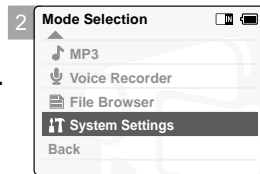

Notes

- * If you select <Back> in the menu, the previous menu appears.
- * A brighter LCD Monitor setting consumes more battery power.

Setting the CAM : Adjusting the LCD Monitor

Adjusting the LCD Colour

You can adjust the colour of the LCD monitor depending on the situation.

1. Move [Mode Selector] down to turn on the CAM and move it down again.
◆ The Mode Selection screen appears.
2. Move the [▲/▼] switch to select *System Settings* and press the [OK] button.
3. Move the [▲/▼] switch to select <Display> and press the [OK] button.
4. Move the [▲/▼] switch to select <LCD Colour> and press the [OK] button.
◆ You can adjust the LCD Colour from 0% to 100%.
5. Move the [▲/▼] switch to select the colour you want.
6. Press the [Back] button to finish setting.

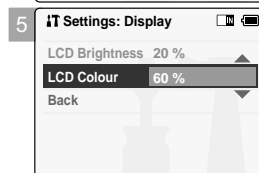
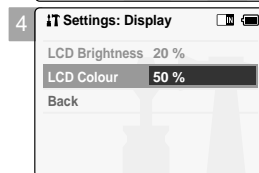
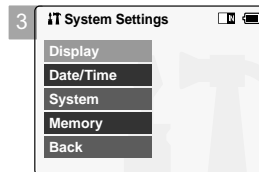
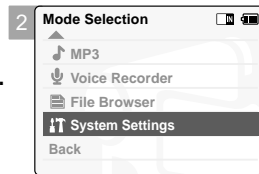

Note

- * If you select <Back> in the menu, the previous menu appears.

Setting the CAM : Adjusting Date/Time

Setting Time

The built-in clock creates the time stamp. You can adjust the time you use.

1. Move [Mode Selector] down to turn on the CAM and move it down again.
◆ The Mode Selection screen appears.
2. Move the [▲/▼] switch to select *System Settings* and press the [OK] button.
3. Move the [▲/▼] switch to select <Date/Time> and press the [OK] button.
4. Move the [▲/▼] switch to select <Set Time> and press the [OK] button.
5. Move the [▲/▼] switch to set time and press the [OK] button.
◆ Move the [▲/▼] switch to change the setting and press the [OK] button to confirm selection and move to the next setting.
6. Press the [Back] button to finish setting.

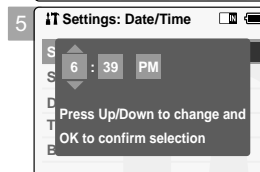
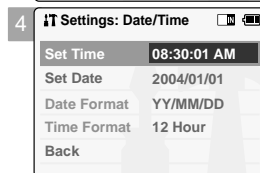
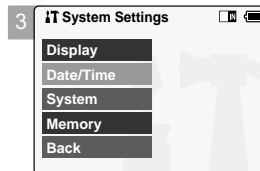
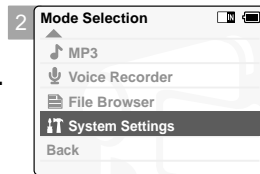

Note

※ If you select <Back> in the menu, the previous menu appears.

Setting the CAM : Adjusting Date/Time

Setting Date

The built-in calendar creates the date stamp. You can adjust the date you use.

1. Move [Mode Selector] down to turn on the CAM and move it down again.
◆ The Mode Selection screen appears.
2. Move the [▲/▼] switch to select *System Settings* and press the [OK] button.
3. Move the [▲/▼] switch to select <Date/Time> and press the [OK] button.
4. Move the [▲/▼] switch to select <Set Date> and press the [OK] button.
5. Move the [▲/▼] switch to set date and press the [OK] button.
◆ Move the [▲/▼] switch to change the setting and press the [OK] button to confirm selection and move to the next setting.
6. Press the [Back] button to finish setting.

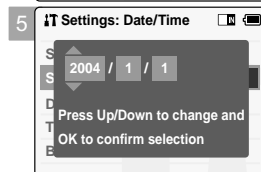
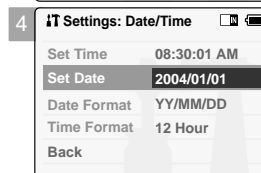
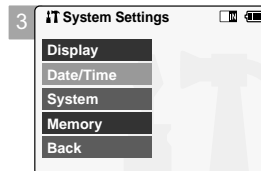
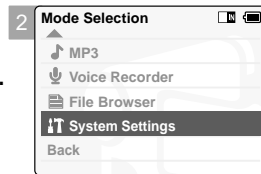

Note

※ If you select <Back> in the menu, the previous menu appears.

Setting the CAM : Adjusting Date/Time

Setting Date Format

You can select the date format to display.

1. Move [Mode Selector] down to turn on the CAM and move it down again.
◆ The Mode Selection screen appears.
2. Move the [▲/▼] switch to select *System Settings* and press the [OK] button.
3. Move the [▲/▼] switch to select <Date/Time> and press the [OK] button.
4. Move the [▲/▼] switch to select <Date Format> and press the [OK] button.
5. Move the [▲/▼] switch to select desired format and press the [OK] button.
◆ **YY/MM/DD**: The date is displayed in order as Year/Month/Date.
◆ **DD/MM/YY**: The date is displayed in order as Date/Month/Year.
◆ **MM/DD/YY**: The date is displayed in order as Month/Date/Year.
6. Press the [Back] button to finish setting.

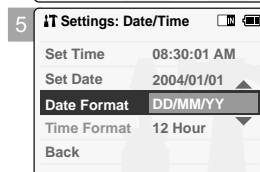
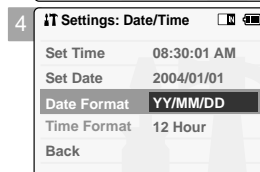
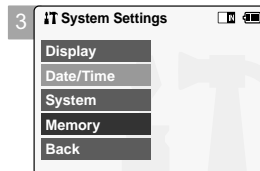
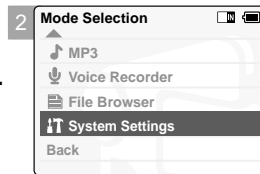

Note

* If you select <Back> in the menu, the previous menu appears.

Setting the CAM : Adjusting Date/Time

Setting Time Format

You can select the time format to display.

1. Move [Mode Selector] down to turn on the CAM and move it down again.
◆ The Mode Selection screen appears.
2. Move the [▲/▼] switch to select *System Settings* and press the [OK] button.
3. Move the [▲/▼] switch to select <Date/Time> and press the [OK] button.
4. Move the [▲/▼] switch to select <Time Format> and press the [OK] button.
5. Move the [▲/▼] switch to select desired format and press the [OK] button.
◆ **12 Hour**: The time is displayed as the unit of 12 hours.
◆ **24 Hour**: The time is displayed as the unit of 24 hours.
6. Press the [Back] button to finish setting.

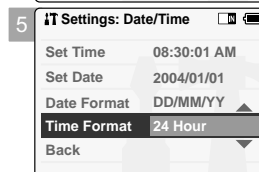
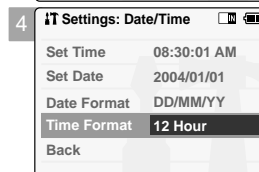
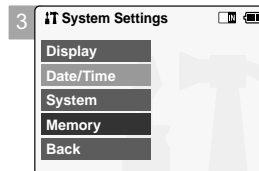
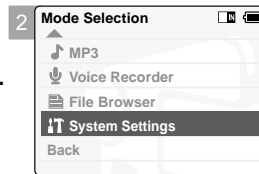

Note

* If you select <Back> in the menu, the previous menu appears.

Setting the CAM : Setting the System

Setting the Auto Shut off

To save energy or battery, you can set the Auto Shut off function.

1. Move [Mode Selector] down to turn on the CAM and move it down again.
◆ The Mode Selection screen appears.
2. Move the [▲/▼] switch to select *System Settings* and press the [OK] button.
3. Move the [▲/▼] switch to select <System> and press the [OK] button.
4. Move the [▲/▼] switch to select <Auto Shut off> and press the [OK] button.
5. Move the [▲/▼] switch to select desired setting and press the [OK] button.
◆ **Off**: Cancel the Auto Shut off function.
◆ **5 Minutes**: the CAM turns off after 5 minutes.
6. Press the [Back] button to finish setting.

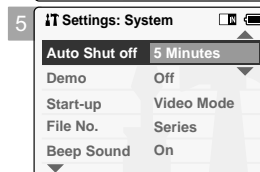
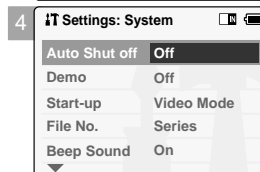
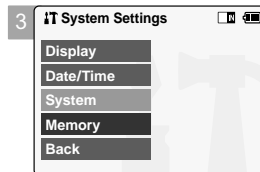
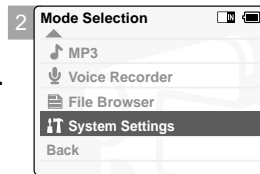

Notes

- * If the CAM turns off after 5 minutes, you can use the CAM again after turning it on.
- * If you select <Back> in the menu, the previous menu appears.
- * The <Auto Shut off> function cannot be operated if you connect the power adapter to the CAM. It can be only operated when you insert battery pack into the CAM.

Setting the CAM : Setting the System

Setting the Demo Function

Demo function will allow you to view all the functions that the CAM supports. Demo will run for up to 5 minutes.

1. Move [Mode Selector] down to turn on the CAM and move it down again.
◆ The Mode Selection screen appears.
2. Move the [▲/▼] switch to select *System Settings* and press the [OK] button.
3. Move the [▲/▼] switch to select <System> and press the [OK] button.
4. Move the [▲/▼] switch to select <Demo> and press the [OK] button.
5. Move the [▲/▼] switch to select desired setting and press the [OK] button.
◆ **Off**: Cancel the Demo function.
◆ **5 Minutes**: Start the Demo function in 5 minutes.
◆ **Play Now**: Start the Demo function now.
6. Press the [Back] button to finish setting.

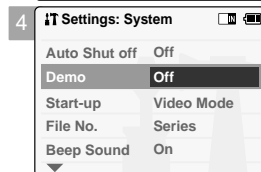
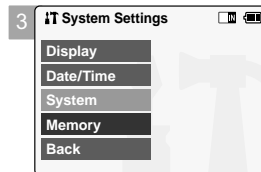
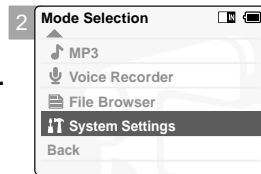

Note

- * If you select <Back> in the menu, the previous menu appears.
- * If you set the Demo function, it operates only in Video Record.

Setting the CAM : Setting the System

Setting Start-up Mode

You can select the starting mode displayed when you turn the CAM on.

1. Move [Mode Selector] down to turn on the CAM and move it down again.
◆ The Mode Selection screen appears.
2. Move the [▲/▼] switch to select *System Settings* and press the [OK] button.
3. Move the [▲/▼] switch to select <System> and press the [OK] button.
4. Move the [▲/▼] switch to select <Start-up> and press the [OK] button.
5. Move the [▲/▼] switch to select desired setting and press the [OK] button.
◆ **Video Mode:** The CAM starts up in the Video Mode.
◆ **Previous Mode:** The CAM starts up in the mode you used last.
6. Press the [Back] button to finish setting.

Note

※ If you select <Back> in the menu, the previous menu appears.

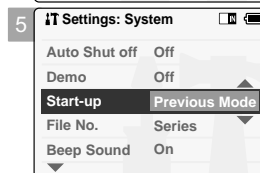
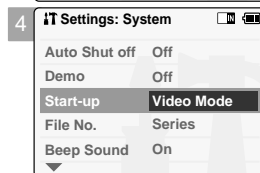
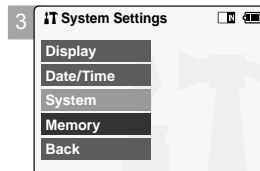
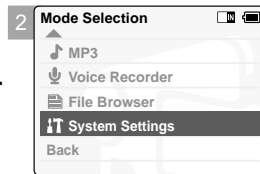

Setting the CAM : Setting the System

Setting the File No. Function

You can set the file numbers so that they reset each time Memory stick is formatted, or so that they count up continuously.

1. Move [Mode Selector] down to turn on the CAM and move it down again.
◆ The Mode Selection screen appears.
2. Move the [▲/▼] switch to select *System Settings* and press the [OK] button.
3. Move the [▲/▼] switch to select <System> and press the [OK] button.
4. Move the [▲/▼] switch to select <File No.> and press the [OK] button.
5. Move the [▲/▼] switch to select desired setting and press the [OK] button.
◆ **Series:** Numbering is continuous between the Memory Sticks, so that the first file number assigned on a new Memory Stick is 1 more than the last file number assigned on the previous Memory Stick.
◆ **Reset:** When the Memory Stick is formatted, the file number resets to its default value. (100-0001)
6. Press the [Back] button to finish setting.

Notes

- ※ If you select <Back> in the menu, the previous menu appears.
- ※ When you set file number to 'Series', each file is assigned a different number avoiding duplication of numbers. It is convenient when you want to manage your files on a PC.

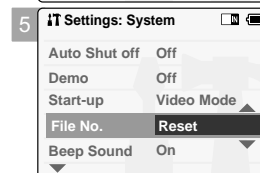
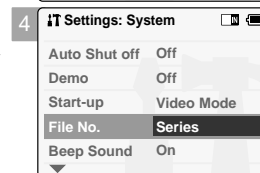
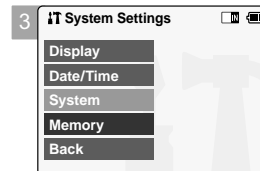
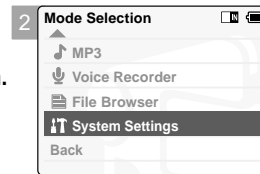

Setting the CAM : Setting the System

Setting the Beep Sound

You can set the sound of the CAM as you want.

1. Move [Mode Selector] down to turn on the CAM and move it down again.
◆ The Mode Selection screen appears.
2. Move the [▲/▼] switch to select *System Settings* and press the [OK] button.
3. Move the [▲/▼] switch to select <System> and press the [OK] button.
4. Move the [▲/▼] switch to select <Beep Sound> and press the [OK] button.
5. Move the [▲/▼] switch to select desired sound and press the [OK] button.
◆ **On**: Turn the effect sound on.
◆ **Off**: Turn the effect sound off.
6. Press the [Back] button to finish setting.

Note

- * If you select <Back> in the menu, the previous menu appears.
- * When the earphones or Video/Audio cable is connected to the CAM, the beep sound function does not operate.

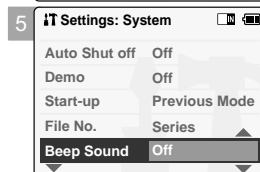
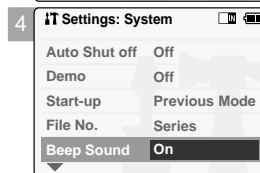
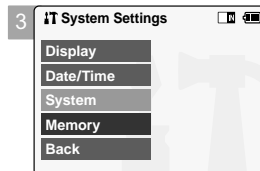
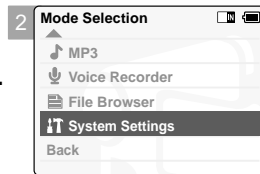

Setting the CAM : Setting the System

Viewing Version Information

You can see the information of the version.

1. Move [Mode Selector] down to turn on the CAM and move it down again.
◆ The Mode Selection screen appears.
2. Move the [▲/▼] switch to select *System Settings* and press the [OK] button.
3. Move the [▲/▼] switch to select <System> and press the [OK] button.
4. Move the [▲/▼] switch to select <Version Info> and press the [OK] button.
◆ The version of the CAM is displayed.
5. Press the [Back] button to finish viewing version information.

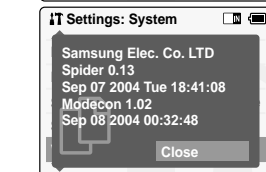
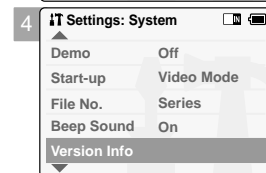
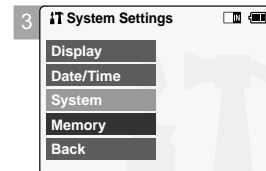
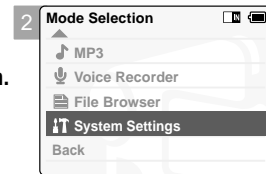

Note

- * If you select <Back> in the menu, the previous menu appears.

Setting the CAM : Setting Memory

Selecting the Storage Type

Select the storage type(internal or Memory Stick, Memory Stick Pro) before recording or taking pictures.

1. Move [Mode Selector] down to turn on the CAM and move it down again.
◆ The Mode Selection screen appears.
2. Move the [▲/▼] switch to select *System Settings* and press the [OK] button.
3. Move the [▲/▼] switch to select <Memory> and press the [OK] button.
◆ If you didn't insert Memory Stick, you cannot select 'External'.
4. Move the [▲/▼] switch to select <Storage Type> and press the [OK] button.
5. Move the [▲/▼] switch to select desired setting and press the [OK] button.
◆ **Internal:** The video, photo, mp3 file or voice file is stored in internal memory.
◆ **External:** The video, photo, mp3 file or voice file is stored in external memory (Memory stick or Memory stick pro).
6. Press the [Back] button to finish setting.

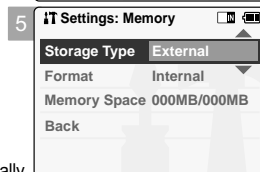
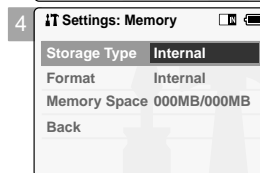
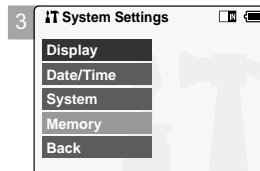
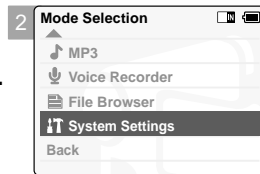

Notes

- ※ If you select <Back> in the menu, the previous menu appears.
- ※ 'Internal' is selected by default.
- ※ If you insert the Memory Stick or Memory Stick Pro, the memory type selection screen appears automatically.

Setting the CAM : Setting Memory

Formatting the Memory

You can format the internal memory, Memory Stick or Memory Stick Pro to erase all files.

1. Move [Mode Selector] down to turn on the CAM and move it down again.
◆ The Mode Selection screen appears.
2. Move the [▲/▼] switch to select *System Settings* and press the [OK] button.
3. Move the [▲/▼] switch to select <Memory> and press the [OK] button.
4. Move the [▲/▼] switch to select <Format> and press the [OK] button.
◆ If you didn't insert Memory Stick, you cannot select 'External'.
5. Move the [▲/▼] switch to select desired setting and press the [OK] button.
◆ **Internal:** Format the internal memory. If you select 'Internal', the message is displayed to confirm.
◆ **External:** Format the external memory. If you select 'External', the message is displayed to confirm.
6. Press the [OK] button to format.
◆ Select <Cancel> to cancel formatting.
7. Press the [Back] button to finish setting.

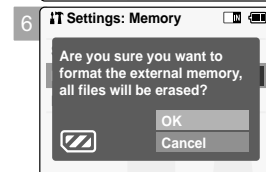
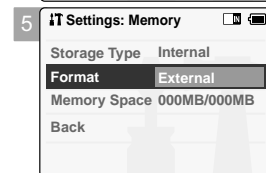
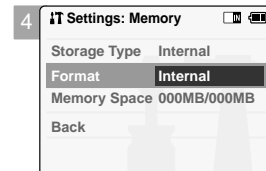
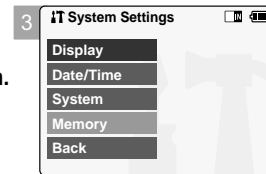

Note

- ※ If you select <Back> in the menu, the previous menu appears.

Setting the CAM : Setting Memory

Viewing Memory Space

You can view usable memory and total memory space of the CAM.

1. Move [Mode Selector] down to turn on the CAM and move it down again.
◆ The Mode Selection screen appears.
2. Move the [▲/▼] switch to select *System Settings* and press the [OK] button.
3. Move the [▲/▼] switch to select <Memory> and press the [OK] button.
4. Move the [▲/▼] switch to select <Memory Space>.
5. Press the [Back] button to finish setting.

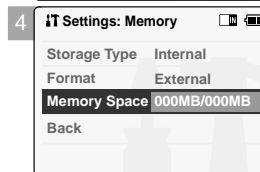
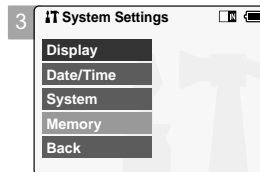
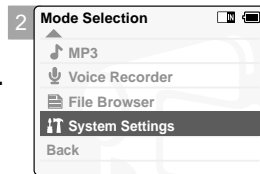

Note

- * If you select <Back> in the menu, the previous menu appears.

Setting the CAM : Using USB Mode

Storing Files to the External Memory

1. Connect the CAM to the PC with the USB cable.

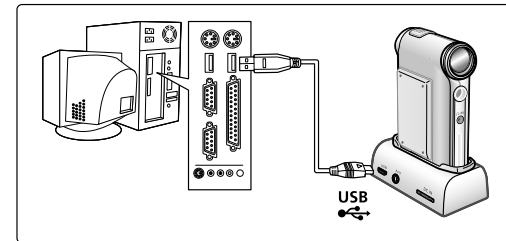

2. Move [Mode Selector] down to turn on the CAM.
◆ USB menu screen appears automatically.
3. Move the [▲/▼] switch to select <USB 2.0 MassStorage> or <USB 1.1 MassStorage> and press the [OK] button.
◆ Your PC recognises the USB device automatically. You may install the USB Driver manually on Windows 98SE operating system.
4. Disconnect the USB cable if you finish storing.

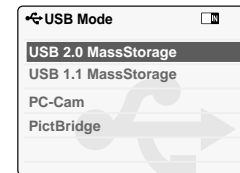

Notes

- * Select <USB 1.1 MassStorage> when <USB 2.0 MassStorage> does not work depending on your PC environment.
- * If you disconnect the USB cable from the PC or the CAM during the data transfer, the data transfer will stop and the data may be damaged.
- * If you connect the USB cable to a PC using a USB HUB or with other device at the same time, it might cause conflict and may not work properly. If this occurs, remove all other devices and try the connection again.
- * Install the Windows 98SE Driver on Windows 98SE operating system using supplied CD. Refer to page 113 for further details.
- * It takes about 30 minutes if you download or upload the file of 1GB by connecting the USB cable.

Setting the CAM : Using USB Mode

USB Speed depending on the System

Hi Speed USB is not guaranteed except for Microsoft(Windows) or Apple(Mac OS X) or supplied Driver.

- * Windows 98SE/ME: Full Speed USB
- * Windows XP: Over Service Pack 1 - Hi Speed USB
- * Windows 2000: Over Service Pack 4 - Hi Speed USB
- * Mac OS X: Over 10.3. - Hi Speed USB

System Environment

	Windows Environment		Macintosh Environment	
	Minimum	Recommended	Minimum	Recommended
CPU	Pentium III, 600MHz	Pentium 4, 2GHz	G3 500MHz	G4 Processor
OS	Windows 98SE/ME	Windows 2000/XP	Mac OS 10.2	Mac OS 10.3
Memory	128MB	512MB or above	128MHz	512MB or above
Free space on the hard disk	200MB(For applications only. Apart from this, 1GB or more free space	2GB or above	200MB(For applications only. Apart from this, 1GB or more free space	2GB or above
Display Resolution	800x600 dots 16-bit colour	1024x768 dots 24-bit colour	800x600 dots 16-bit colour	1024x768 dots 24-bit colour
USB	USB 1.1	USB 2.0 High Speed	USB 1.1	USB 2.0 High Speed

Notes

- * Not all PCs configured with the above environment are guaranteed to operate properly.
- * PCs used via a USB hub or with a USB card are out of the scope of guarantee.
- * If your OS is Windows 2000/XP, log in as the [Administrator(administrator of the PC)] (or a user with the equivalent privileges) to install the OS.
- * If the capacity of PC is low, the video file may not be played normally or the file is often stopped.
- * If the capacity of PC is low, it may take long time to edit the video file.

Setting the CAM : Using USB Mode

Using PC Cam

You can use this the CAM as a PC camera for video chatting, video conference and other PC camera applications.

1. **Connect the CAM to the PC with the USB cable.**
2. **Move [Mode Selector] down to turn on the CAM.**
◆ USB mode screen appears automatically.
3. **Move the [▲/▼] switch to select <PC-Cam> and press the [OK] button.**

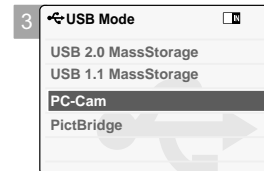
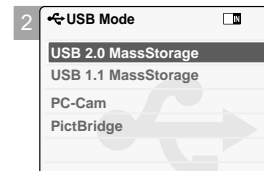

Notes

- * This function requires the specified USB Streaming Driver and Software to be installed. Refer to page 112 for further details.
- * The CAM can be used as a PC Camera for programs such as Windows Messenger. The use of the PC Cam varies depending on the Software. Refer to the documentation of the respective software products.
- * PC-Cam function is operated as 'Full Speed' in the capacity of Windows ME or over.

Setting the CAM : Using USB Mode

Connecting the CAM to a Printer

By connecting the CAM to printers with PictBridge support (sold separately), you can send images from the internal memory or external memory (Memory Stick or Memory Stick Pro) directly to the printer with a few simple operations.

1. **Connect the CAM to the printer with PictBridge support with the USB cable.**
2. **Move [Mode Selector] down to turn on the CAM.**
◆ USB mode screen appears automatically.
3. **Move the [▲/▼] switch to select <PictBridge> and press the [OK] button.**
4. **Move the [▲/▼] switch to select <Date> and press the [OK] button.**
5. **Move the [▲/▼] switch to select <On> or <Off> and press the [OK] button.**
6. **Move the [▲/▼] switch to select <Copies> and press the [OK] button.**
7. **Move the [▲/▼] switch to select desired number and press the [OK] button.**
◆ You can select the number of copy from 1 to 99.
8. **Move the [▲/▼] switch to select <Print> and press the [OK] button.**

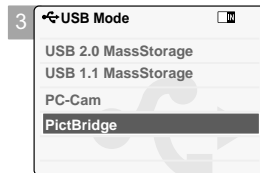
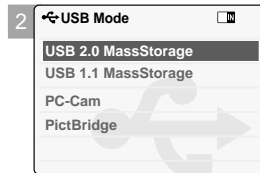

Notes

- * If you select <Back> in the menu, the previous menu appears.
- * If you want to select the next or previous photo, select <Next> or <Previous> using [▲/▼] switch.

5

Miscellaneous Information

Connecting the CAM with other Devices	106
Connecting the CAM to TV	106
Connecting the CAM to VCR or DVD Recorder	107
Copying Video files to a VCR Tape	108
Connecting the CAM to a PC using the USB cable	109
Installing Programs	110
Installing Image Mixer	110
Installing for using PC-Cam	112
Installing Windows98SE Driver	113
Printing Photos	115
Printing with PictBridge Function	115
Printing Photos with DPOF Files	116

Miscellaneous Information: Connecting the CAM with other Devices

Connecting the CAM to TV

You can connect the CAM to a TV set directly to play video files on TV monitor.

1. Connect the AV Input/Output cable to the AV Input/Output Jack of the CAM.
2. Connect the Video/Audio cable to the external input terminal of your TV set by matching the colours of the terminals.
3. Move [Mode Selector] down to turn on the CAM.
◆ The Video Record screen appears.
4. Press the [Back] button to play the video file in Video Record mode.
5. Move [▲/▼] switch to find the video file you want to play.
6. Press the [OK] button to play the video file.

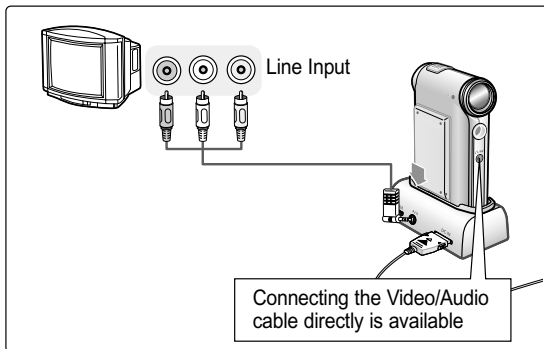

Notes

- ※ You can stop and play video files using the same button as used for playing video files on the LCD monitor of the CAM. (Refer to page 38)
- ※ If you AV Mono cable to the CAM, the video file cannot be played.
- ※ If you connect the AV Jack to the cradle and the CAM simultaneously, AV output signal decreases to 50%. Connect the AV Jack to the only one side.

Miscellaneous Information: Connecting the CAM with other Devices

Connecting the CAM to VCR or DVD Recorder

You can connect the CAM to VCR to copy the recorded files to the video tape.

1. Connect the Video/Audio cable to the AV Input/Output Jack of the CAM.
2. Connect the Video/Audio cable to the external input terminal of your VCR set by matching the colours of the terminals.
3. Connect the Video/Audio cable to the Video line Output and TV line Input.
4. Select the Input on the TV, VCR or the remote control of TV.

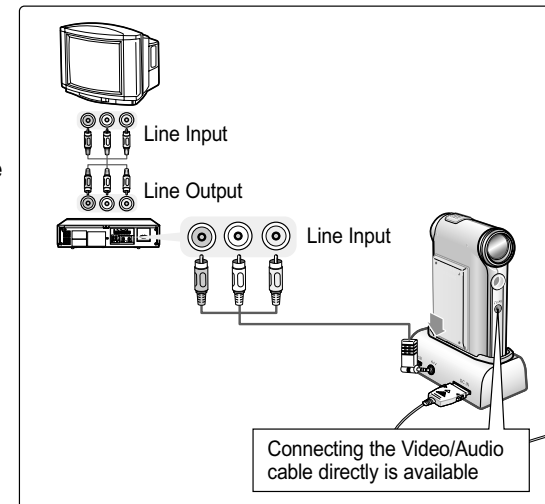

Note

- ※ If TV set has no Line Input, you cannot view the output screen of the CAM.

Miscellaneous Information: Connecting the CAM with other Devices

Copying Video files to a VCR Tape

You can copy your recorded files to a regular blank video tape. Connect the CAM to a VCR using the Audio/Video cable before recording.

1. Insert the blank video tape to the VCR and select 'Line Input'.
2. Move [Mode Selector] down to turn on the CAM and move it down again.
 - ◆ The Mode Selection screen appears.
3. Select <Play> in the *Video* mode to find the desired video file with the [▲/▼] switch. (Refer to page 38)
4. Move the [▲/▼] switch to find the video file you want to copy and press the [OK] button.
5. Press the [Record/Stop] button on the VCR to start recording.

Notes

- * Refer to operating instructions of your TV or VCR for detailed information on connecting external devices.
- * You can stop and play video files using the same button as used for playing video files on the LCD monitor of the CAM. (Refer to page 38)

Miscellaneous Information: Connecting the CAM with other Devices

Connecting the CAM to a PC using the USB cable

You can connect the CAM to a PC that supports USB connections. Use the provided USB cable for connection to a PC.

1. Insert the cradle into the CAM.
2. Connect the provided USB cable to USB port of the cradle.
3. Move [Mode Selector] down to turn on the CAM and move it down again.
 - ◆ The Mode Selection screen appears.
4. Connect the other side of the USB cable to the USB port of your PC.

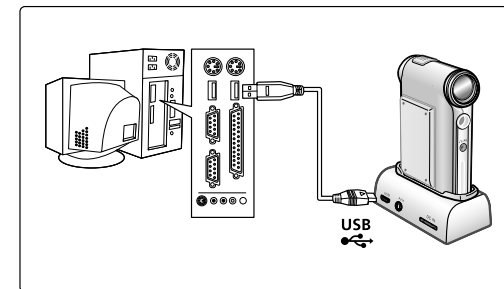

Miscellaneous Information: Installing Programs

Installing Image Mixer

You can edit the video file with this program. And you can use the PC Camera function.

Windows

1. **Quit the file and folder you work.**
2. **Insert the program CD into the CD-ROM drive.**
 - ◆ The Setup screen appears automatically.
 - ◆ Open the CD-ROM Drive in 'My Computer' and double-click <Iminst.exe>.
3. **Click <ImageMixer>**
4. **Select the language.**
5. **Follow the steps appeared on the monitor.**
 - ◆ You can use the Image Mixer after restarting your PC.



Miscellaneous Information: Installing Programs

Macintosh

1. **Quit the file and folder you work.**
2. **Insert the program CD into the CD-ROM drive.**
 - ◆ The Setup screen appears automatically.
 - ◆ If not, double-click the CD-ROM icon on the Desktop, and double-click <Iminstall>.
3. **Click <ImageMixer>.**
4. **Select the language.**
5. **Follow the steps appeared on the monitor.**
 - ◆ You can use ImageMixer after restarting your PC.



Notes

- ※ If Image Mixer appears to not be installed, re-install it again but you should first attempt to uninstall it. Uninstalling 'Image Mixer' should be done via the 'Control Panel' on your PC.
- ※ If you play the MPEG4 video file, the ratio of the screen may not match due to the pixel.
- ※ If you click "ImageMixer", all softwares in the program CD are installed automatically.
- ※ It is necessary to install ImageMixer for playback the CAM recorded video files on your PC.

Miscellaneous Information: Installing Programs

Installing for using PC-Cam

Windows

1. Insert the program CD into the CD-ROM drive.
2. Fix the CAM into the cradle and connect it to a PC with the USB cable.
3. Locate the G:\PC_CAM\ folder on the CD.
4. Follow the steps on the monitor.
 - ◆ If the message of Windows Logo Test to confirm compatibility appears, press 'Next'.

Miscellaneous Information: Installing Programs

Installing Windows98SE Driver (For only Windows98SE)

To use the CAM as a removable drive on Windows98SE, you may need to install the Windows98SE Driver.

1. Insert the program CD into the CD-ROM drive.
2. Fix the CAM into the cradle and connect it to a PC with the USB cable. The PC recognises the CAM and 'Found New Hardware Wizard' appears.
3. Locate the G:\Storage folder on the CD.
4. Follow the steps on the monitor.



Miscellaneous Information: Connecting the CAM with other Devices

Disconnecting USB Connection

After completing the data transfer, you must disconnect the cable in the following way.

1. Select the removable disk icon and click the right mouse button to select 'Safely Remove Hardware'.
2. Select 'Stop' and disconnect the USB cable when the pop-up screen disappears.

Notes

- ※ If you disconnect the USB cable from the PC or the CAM during the data transfer, the data transfer will stop and the data may be damaged.
- ※ If you connect the USB cable to a PC using a USB HUB or with other device at the same time, it might cause conflict and may not work properly. If this occurs, remove all other devices and try the connection again.
- ※ The CAM may operate abnormally in the recommended system environment depending on the assembling of PC. For example, the video file is played abnormally.
- ※ Once you select the USB 2.0 MassStorage, USB 1.1 MassStorage, PC-Cam or PictBridge, you cannot select the modes. Disconnect the USB cable or turn on the CAM again to select the modes.
- ※ If you disconnect the USB cable, the message 'Now refresh file list' appears for 1 second.
- ※ All operation mentioned on the page 102 may not be guaranteed in the system environment.

Miscellaneous Information: Printing Photos

Printing with PictBridge Function

With the PictBridge Support, you can control the printer directly through the CAM in order to print out stored pictures.

For direct printing of your stored pictures using the PictBridge function, you must connect the CAM to a PictBridge printer using a USB cable.

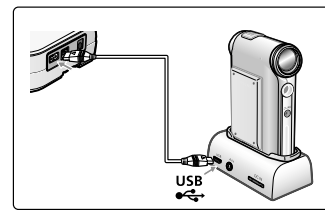

1. **Connect the CAM to the PC with the USB cable.**
2. **Move [Mode Selector] down to turn on the CAM.**
◆ USB menu screen appears automatically.
3. **Move the [▲/▼] switch to select <PictBridge> and press the [OK] button.**
4. **Move the [▲/▼] switch to select <Copies> and press the [OK] button.**
5. **Move the [▲/▼] switch to select desired number and press the [OK] button.**
◆ You can select the number of copy from 1 to 99.
6. **Move the [▲/▼] switch to select <Print> and press the [OK] button.**

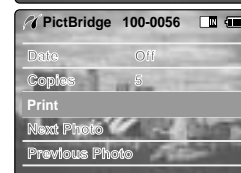
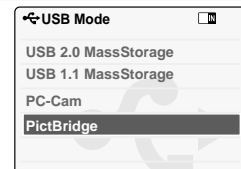

Notes

- ※ If you select <Back> in the menu, the previous menu appears.
- ※ If you want to select the next or previous photo, select <Next> or <Previous> using [▲/▼] switch.
- ※ For further details about printing photos, refer to the User's manual of the printer.

Miscellaneous Information: Printing Photos

Printing Photos with DPOF Files

DPOF (Digital Printing Order Format) defines the print information for the specific photos and number of each photo on the Memory Stick or Memory Stick Pro. You can easily make prints on a DPOF compatible printer or order copies.

Printing DPOF files of the Memory Stick

1. Set the print information for the photo you want to print. (Refer to page 59)
2. Insert the Memory Stick into the photo printer.
3. Follow the steps of the printer to print out photos.

Note

- * For further details about printing photos, refer to the User's manual of the printer.

Maintenance : Cleaning and Maintaining the CAM

After using the CAM

- * **For the safekeeping of the CAM, follow these steps.**

- ✓ Turn the CAM off.
- ✓ Remove the Battery Pack (refer to page 19).
- ✓ Remove the Memory Stick (refer to page 33).

- * **To prevent any damage to the LCD monitor, do not apply excessive force on its moving parts.**

- * **Do not drop or in anyway shock the CAM.**

- * **For prolonged use of the CAM, avoid using it in places subject to excessive humidity or dust.**

- * **Do not leave the CAM in places subject to:**

- ✓ Excessive humidity, steam, soot or dust
- ✓ Excessive shock or vibration.
- ✓ Extremely high (over 50°C or 122°F) or extremely low (under 0°C or 32°F) temperatures.
- ✓ Strong electromagnetic fields.
- ✓ Direct sunlight or in a closed car on a hot day.

- * **For the safe use of the battery pack, follow these.**

- ✓ To conserve battery power, be sure to turn off the CAM power when not in use.
- ✓ Battery consumption may vary depending on the condition of use. Recording with many starts and stops, frequent zooming, and recording in low temperatures will shorten actual recording times.
- ✓ Dispose of used battery packs promptly. Do not dispose of them in fire.
- ✓ The battery pack will become warm during charging and use. This is not a malfunction.
- ✓ The battery pack has a limited service life. If the period of use becomes noticeably shorter with a normal charge, the battery pack is at the end of its service life. Replace it with a new battery pack.

- * **For the safe use of the Memory Stick and the Memory Stick Pro, follow these.**

- ✓ The Memory Stick should be stored away from heaters and other heat sources. Avoid storing Memory Sticks under direct sunlight and avoid electromagnetic fields.
- ✓ Do not power off any devices while transferring data, as this may destroy the data.
- ✓ Back up your image data often to a hard disk or other permanent storage media.
- ✓ Format the Memory Stick periodically.
- ✓ When formatting the Memory Stick or Memory Stick Pro, format in the CAM. If you format it on PC, use the 'Memory Stick Formatter' in the supplied software CD.

Maintenance : Cleaning and Maintaining the CAM

Cleaning the Body

※ To Clean the Exterior of the CAM

- ✓ To clean the exterior, use a soft dry cloth. Wipe the body gently.
Do not apply excessive force when cleaning, gently rub the surface.
- ✓ The LCD monitor surface should not be pressed. Use a soft dry cloth to clean the surface.
- ✓ To clean the lens, use an optional air blower to blow out dirt and other small objects. Do not wipe the lens with cloths or your fingers. If necessary, use lens cleaning paper.
- ✓ Do not use thinner, alcohol or benzene for cleaning. Otherwise, the finish may be damaged.
- ✓ Cleaning should be done only after the battery pack has been removed, and other power sources have been disconnected.

Note

- ※ If the lens look dimmer, turn off the CAM and leave it for about 1 hour.

Using the Built-in Rechargeable Battery

The CAM incorporates a rechargeable lithium cell that maintains the date and other settings even when the AC adaptor and the battery are removed. The rechargeable lithium cell is automatically recharged when the CAM is used.

Charging the Built-in Rechargeable Battery

- ※ If The CAM is not used at all, the cell runs down in 5 days. In this case, connect the AC adaptor to the CAM and turn on the power switch. Then leave it for 24 hours.
After that, set the date and other settings again.

Maintenance : Cleaning and Maintaining the CAM

Using the CAM Abroad

- ※ Each country or region has its own electric and colour systems.
- ※ Before using the CAM abroad, check the following items:

Power Sources

- ※ You can use the CAM in any country or area with the supplied AC Power Adapter where the power input range is 100V ~ 240V, 50/60Hz.
- ※ Use a commercially available AC plug adapter if necessary, depending on the design of the local wall outlets.

Colour System

- ※ You can view your video files using the built-in LCD monitor.
However, to view your recordings on a television set or to copy it to a video cassette recorder (VCR), the television set or the VCR must comply with PAL-compatible and have the appropriate Audio / Video ports. Otherwise, you may need to use a separate Video Format Transcoder (PAL-NTSC format Converter).

PAL-Compatible Countries / Regions

Australia, Austria, Belgium, Bulgaria, China, CIS, Czech Republic, Denmark, Egypt, Finland, France, Germany, Greece, Great Britain, Holland, Hong Kong, Hungary, India, Iran, Iraq, Kuwait, Libya, Malaysia, Mauritius, Norway, Romania, Saudi Arabia, Singapore, Slovak Republic, Spain, Sweden, Switzerland, Syria, Thailand, Tunisia, etc.

NTSC-Compatible Countries / Regions

Bahamas, Canada, Central America, Japan, Mexico, Philippines, Korea, Taiwan, United States of America, etc.

Troubleshooting

Self Diagnosis Display

Display	Informs that	Action
Not enough free space	Not enough free space for saving files	Check the space of internal memory or the Memory Stick.
Corrupted file	The file is corrupted	Delete the corrupted file.
Paper error	The paper is insufficient.	Check the paper in the printer. If there is no paper, insert paper.
Printer error	The paper is caught in the printer.	Check that paper is caught in the printer. Pull out the caught paper.
Ink error	Ink is low.	Check if the ink or toner is low.
Wrong error	The file is wrong.	Check that the file is JPEG.
USB transfer error	The error is occurred while transferring data.	Disconnect the USB cable and connect it again.
Low battery	Battery is low.	Charge the battery pack or connect the AC Adapter.
Holding the key	The hold key is locked.	Unlock the hold key and operate the CAM.
Card error	The memory card is corrupted.	Format the Memory Stick or replace it with new one.
Not formatted	Format the memory card.	Format the Memory Stick.
Write error	Failed to write.	Check the memory space or format the memory.
Read error	Failed to read.	Delete the file.
Not supported format	The format is not supported.	The AVI or JPEG file that is not supported. Check the supported file on the page 29.
Write protected	Memory Stick is protected to write.	Unlock the Memory Stick.
MPEG decoding error	The video file is corrupted.	Delete the corrupted file.

* If these instructions do not solve your problem, contact your nearest Samsung dealer or authorized service centre/personnel.

Symptom	Possible Causes	Measure
No power is supplied	The power is not connected properly The battery is dead The battery is too cold	Connect the AC adapter properly, page 23 Replace the dead battery pack Warm up the battery or move to warmer place
DATE/TIME is wrong	The DATE/TIME is not set	Set the DATE/TIME, pages 88~89
Focus does not adjust automatically	Focus is set to manual mode Recording was done in a dark place Lens is covered with condensation	Set focus to AUTO Use strobe or lit the place Clear the lens and check the focus
The Memory Stick will not load properly	Memory stick is in wrong position Something fills in the Memory Stick slot	Insert the Memory Stick properly, page 33 Clear the Memory Stick slot

Troubleshooting

Symptom	Possible Causes	Measure
Colour balance of picture is not natural	White balance adjustment is required	Set proper white balance, page 65
Digital zoom does not work	Digital special effect is applied	Turn off the digital special effects, page 51
Files stored in the Memory Stick cannot be deleted	Memory Stick is protected File is locked	Remove the protection tab of Memory Stick Remove the lock on the file, page 82
Images on the LCD monitor appear dark	Ambient is too bright Ambient temperature is too low	Adjust the brightness and angle of LCD Low temperatures might produce a dark LCD display This is not a malfunction
Rear of the LCD monitor is hot	Prolonged use of LCD monitor	Close the LCD monitor to turn if off, or turn your device off to cool down
Play, rewind and fast forwarding do not work	The Photo Mode is selected	Select 'Video Mode' and select 'Play'
Memory Stick cannot be played back (Photo mode)	The Video Mode is selected	Select 'Photo Mode' and select 'View'
No picture is taken when is fully pressed	Not enough free memory space is remained Memory card is formatted by different devices	Delete files from the Memory Stick Format the Memory Stick on the CAM
Built-in Light will fire	Light is forced to cancel Light is not available for recording	Select different Light mode, page 62
Cannot Record a video	The Photo Mode is selected	Select 'Video Mode'

Using the Menu

Video

1. Record
2. Play
3. File Options
 - Delete
 - Selected
 - All
 - Cancel
 - Lock
 - Selected
 - All
 - Cancel
 - Copy To
 - Selected
 - All
 - Cancel
 - PB Option
 - Selected
 - All
 - Cancel
 - Back
4. Settings
 - Size
 - 720
 - 352
 - Quality
 - Super Fine
 - Fine
 - Normal
 - Focus
 - AF
 - MF
 - EIS
 - On
 - Off

Photo

1. Capture
 2. View
 3. File Options
 - Delete
 - Selected
 - All
 - Cancel
 - Lock
 - Selected
 - All
 - Cancel
 - Copy To
 - Selected
 - All
 - Cancel
 - 4. Settings
 - Size
 - 800X600
 - 640X480
 - Light
 - Auto
 - On
 - Off
 - Focus
 - AF
 - MF
 - EIS
 - On
 - Off
- White Balance
 - Auto
 - Hold
 - Outdoor
 - Indoor
 - Program AE
 - Auto
 - Sports
 - Spotlight
 - Sand/Snow
 - HS Shutter
 - BLC
 - Off
 - On
 - Effect
 - Off
 - Art
 - Mosaic
 - Sepia
 - Negative
 - Mirror
 - B&W
 - Emboss
 - Digital Zoom
 - Off
 - On
 - Back
 - 5. Back

MP3

1. Play Options
 - Repeat
 - All
 - Off
 - One
 - Back
2. File Options
 - Delete
 - Selected
 - All
 - Cancel
 - Lock
 - Selected
 - All
 - Cancel
 - Copy To
 - Selected
 - All
 - Cancel
 - Back
3. Back

Using the Menu

Voice Recorder

1. Record
2. Play
3. File Options
 - Delete
 - Selected
 - All
 - Cancel
 - Lock
 - Selected
 - All
 - Cancel
 - Copy To
 - Selected
 - All
 - Cancel
 - Back
4. Back

File Browser

1. Delete
 - Selected
 - All
 - Cancel
2. Lock
 - Selected
 - All
 - Cancel
3. Copy To
 - Selected
 - All
 - Cancel
4. File Info
 - Close
5. Back

System Settings

1. Display
 - LCD Brightness
 - 0%
 - :
 - 100%
 - LCD Colour
 - 0%
 - :
 - 100%
 - Back
2. Date/Time
 - Set Time
 - Set Date
 - Date Format
 - YY/MM/DD
 - DD/MM/YY
 - MM/DD/YY
 - Time Format
 - 12 Hour
 - 24 Hour
 - Back

USB Mode

3. System
 - Auto Shut off
 - Off
 - 5 Minutes
 - Demo
 - Off
 - 5 Minutes
 - Play Now
 - Start-up
 - Video Mode
 - Previous Mode
 - File No.
 - Series
 - Reset
 - Beep Sound
 - On
 - Off
 - Version Info
 - Back
4. Memory
 - Storage Type
 - Internal
 - External
 - Format
 - Internal
 - External
 - Memory Space
 - 000MB/000MB
 - Back
5. Back

Specifications

Model Name	VP-M102/VP-M105/VP-M110
the CAM System	
Video Recording System	MPEG4 AVI Format
Photo System	JPEG (DPOF, Exif 2.2)
MP3	Stereo Playing
Voice	WAVE file record/play (8KHz Sampling, 16 bit, Stereo)
Memory	Internal memory/Memory Stick/Memory Stick Pro
Recording/Playing time	Refer to page 30
CCD Pixel	1/6 inch CCD, 800K(Maximum)
Optical Zoom Ratio	x10
Focal Length	f=2.4~24mm, F1.8~2.4
Minimum Illumination	3.0 Lux
LCD Monitor	2.0" Trans Reflective, 210K
Cradle Connectors	
USB	Mini-B type (USB 2.0 High Speed)
The CAM Connector	Special 22Pin Connector
AV Output	Video (1.0Vp_p), Audio (-7.5dBm 47K Ω , Stereo)
DC Power In Connector	Special 22Pin Connector
General	
Operating Temperature	0°C~40°C
Operating Humidity	10%~80%
Power Source	3.8V (Li-Polymer Battery pack), 4.8V (AC Adapter)
Power Consumption	3.0W (LCD ON)
Dimension(WxHxD)	58.8mm x 92.7mm x 26.3mm
Weight	150g (Including the Lithium Polymer Battery Pack)
Built-in Microphone	Omni-directional Stereo condenser microphone

Specifications

Model Name	VP-M102/VP-M105/VP-M110	
The CAM Connectors		
Common connector	Earphone	\emptyset 3.5 Stereo
	AV output	Video (1.0p_p, 75 Ω), Audio (-7.5dBm 47K Ω , Stereo)
Cradle Connector	Special 22Pin Connector	
DC Power In Connector	Special 22Pin Connector	
AC Adapter		
Power Requirement	AC 100~240V, 50/60Hz	
DC Output	DC 4.8V, 1.0A	
Dimensions	70mm x 30mm x 42mm	
Weight	80g (Including DC cable)	

Index

- A -		EIS47, 64
AF46, 63		
Auto Shut off92		
- B -		
Beep Sound96		
BLC50, 67		
- C -		
Capturing54		
Cleaning and Maintaining the CAM117		
- D -		
Date89		
Demo93		
Digital Zoom52		
Display button27		
DPOF59, 116		
- E -		
Effect51		
	- F -	
	File Browser81	
	Focus46, 63	
	Format99	
	Function button26	
	- I -	
	Image Mixer110	
	- L -	
	LCD Brightness86	
	LCD Colour87	
	Light62	
	Lithium Polymer Battery pack13	
	- M -	
	Memory Space100	
	Memory Stick33	

Index

Memory type32	- T -
Menu button14	Time88
MF46, 63	Troubleshooting120
- O -	
OSD16	
- P -	
PB Option43	
PictBridge115	
Power switch14	
Program AE49, 66	
- R -	
Repeat Play72	
- S -	
Start-up Mode94	
Storage type98	
	- U -
	USB Cable13
	USB mode101
	- Y -
	Version Information97
	- W -
	White Balance48, 65
	- Z -
	Zooming In and Out37, 55

ENGLISH

Power Sources (United Kingdom Only)

The mains lead on the power adapter is supplied with a moulded plug incorporating a fuse.

The value of the fuse is indicated on the pin face of the plug and, if it requires replacing, a fuse approved to BS1362 of the same rating must be used.

Never use the plug with the fuse cover omitted if the cover is detachable.

If a replacement fuse cover is required, it must be of the same colour as the pin face of the plug.

Replacement covers are available from your dealer.

If the fitted plug is not suitable for the power points in your house or the cable is not long enough to reach a power point, you should obtain a suitable safety approved extension lead or consult your dealer for assistance.

However, if there is no alternative to cutting off the plug, remove the fuse and then safely dispose of the plug.

Do NOT connect the plug to a mains socket as there is a risk of shock hazard from the bared flexible cord.

IMPORTANT

The wires in the mains lead are coloured in accordance with the following code:

BLUE = NEUTRAL BROWN = LIVE

As these colours may not correspond to the coloured marqueings identifying the terminals in your plug, proceed as follows:

The wire coloured BLUE must be connected to the terminal marqueeed with the letter N or coloured BLUE or BLACK.

The wire coloured BROWN must be connected to the terminal marqueeed with the letter L or coloured BROWN or RED.

WARNING

Do not connect either wire to the earth terminal marqueeed with the letter E or the earth symbol, , or coloured GREEN or GREEN and YELLOW.

NOTE

This page is applicable to Great Britain only.



UNITED KINGDOM

This Samsung product is warranted for the period of twelve (12) months from the original date of purchase, against defective materials and workmanship. In the event that warranty service is required, you should return the product to the retailer from whom it was purchased.

However, Samsung Authorised Dealers and Authorised Service Centres in other EC Countries will comply with the warranty on the terms issued to purchasers in the country concerned. In case of difficulty, details of our Authorised Service Centres are available from:

**Samsung Electronics (U.K.) Ltd.,
Euro Service Centre, Stafford Park 12,
TELFORD, Shropshire TF3 3BJ,
Tel: 0870) 242 0303, Fax: 01952) 297617**

■ WARRANTY CONDITIONS

1. The warranty is only valid if, when warranty service is required, the warranty card is fully and properly completed and is presented with the original invoice or sales slip or confirmation, and the serial number on the product has not been defaced.
2. Samsung's obligations are limited to the repair or, at its discretion, replacement of the product or the defective part.
3. Warranty repairs must be carried out by Authorised Samsung Dealers or Authorised Service Centres. No reimbursement will be made for repairs carried out by non Samsung Dealers and, any such repair work and damage to the products caused by such repair work will not be covered by this warranty.



REPUBLIC OF IRELAND

4. This product is not considered to be defective in materials nor workmanship by reason that it requires adaptation in order to conform to national or local technical or safety standards in force in any Country other than the one for which the product was originally designed and manufactured. This warranty will not cover, and no reimbursement will be made for such adaptation nor any damage which may result.
5. This warranty covers none of the following:
 - a) Periodic check ups, maintenance and repair or replacement of parts due to normal wear and tear.
 - b) Cost relating to transport, removal or installation of the product.
 - c) Misuse, including the failure to use this product for its normal purposes or incorrect installation.
 - d) Damage caused by Lightning, Water, Fire, Acts of God, War, Public Disturbances, incorrect mains voltage, improper ventilation or any other cause beyond the control of Samsung.
6. This warranty is valid for any person who legally acquired possession of the product during the warranty period.
7. The consumers statutory rights in any applicable national legislation whether against the retailer arising from the purchase contract or otherwise are not affected by this warranty. Unless there is national legislation to the contrary, the rights under this warranty are the consumers sole rights and Samsung, its subsidiaries and distributors shall not be liable for indirect or consequential loss or any damage to records, compact discs, videos or audio taper or any other related equipment or material.

SAMSUNG ELECTRONICS (U.K.) LTD.



ELLAS (GREECE)

Agaphtevelavth,

Sai eucaristouvme gia thn empistosuvnh pou deivxate sthn **SAMSUNG** me thn agorav authvi th suskeuhvi.

To proiovn autov th **SAMSUNG** eivnai egguhmevno gia perivodo dwvdeka (12) mhnwvn apov thn hmeromhniva agoravi tou gia antallaktikav kai ergatikav. Sthn perivptwsh pou qa creiasteiv episkeuhv, to proiovn autov th **SAMSUNG** qa prevpei na staleiv hv na metafergeiv sto exousiodothmevno **service**, me evxoda tou agorasthv.

Exousiodothmevnoi antiprovwspoi kai exousiodothmevna kevntra **service** se avllei Eurwpaikevi cwvrei, qa apodecqvoun tou ovrou th egguvhsh.

Plhroforivei gia ta exousiodothmevna kevntra **service** sthn Ellavda, mporeivte na pavrete apov thn

FOURLIS TRADE A.E.B.E.

L. Kruonerivou 112
145 68 Kruonevri, Apikhvi

Thl. 210.629.3100

■ Oroi th egguvhsh

1. H egguvhsh iscuvei eavn kai movno eavn to proiovn creiavzetai **service** kai h kavpta egguvhsh evcei plhvri sumpilhrwgeiv kai

sfragisgeiv apov to katavsthma agoravi. Epivshi prevpei na proskomisgeiv kai to timolovgio hv h apovdeixh

lianikhvi pwlhsh, pavnw sthn opoiva o seiriakov ariqmovi tou proiovntoi prevpei na eivnai eukrinhvi.

2. H upocrevwsh th **SAMSUNG** aforav movno thn episkeuhv tou proiovntoi
3. H episkeuhv tou proiovntoi prevpei na anativgetai movno se exousiodothmevna kevntra **service** hv exousiodothmevnoi antiprovwspoi th **SAMSUNG**. Kamiva apozhmivwsh den qa givnei apodekthv gia episkeuhv pou evcei givnei apov mh exousiodothmevno apov thn **SAMSUNG** sunergeivo.
4. To proiovn autov den qa qewrhgeiv ellatmatikov sta ulikav hv sthn ergasiva episkeuhvi eavn qa prevpei na prosarmosteiv, metatrapeiv hv ruqmisteiv vwste na summorfwgeiv me tii topikevi tecnikevi prodiagrafevi hv prodiagrafevi pou iscuvcoun se cwvra avllh apov authv gia thn opoiva proorizovtan hv kataskeuavsthke. H egguvhsh authv den kaluvptei apozhmivvsei gia
 - * Kefalevi bivnteo kai kasetofwnwn
 - * Kefalevi binteokavmera
 - * Gennhtriei aktinwvn laser sta CD, DVD
 - * Thleceiristhvria

- * Lucnivei fouvwn mikrokvumavtwv
- * Prosarmogevi, metatropevi hv ruqmivsei, anexavrthta an eivnai epituchvi hv anepituchvi, ouvte opoiadhvpote zhmiva proevrcetai ex autouv...

5. H egguvhsh authv den kaluvptei kamiva apov tii parakavtw periptwvseiū

- * Periodikouvi elevgcou, sunthvrhsh kai episkeuhv hv antikavstasth merwvn pou ofeivlontai se fusiologikhv fgorav
- * Ta evxoda kai toui kinduvnoui metaforavi pou scetivzontai me thn egguvhsh autouv tou proiovntoi
- * Zhmiva se autov to proiovn pou proevrcetai apovū

- A. Katavcrhsh hv kai kakhv crhvsh, sumperilambanomevnh allav kai mh periorismevnh seū
Mh crhvsh autouv tou proiovntoi gia toui skopouvi pou fusiologikav proorivzetai hv sumvwfna me tii odhgivei crhvsevi gia thn swsthv crhvsh kai sunthvrhsh autouv tou proiovntoi

Thn egkavstasth kai crhvsh tou proiovntoi me trovpoi pou antivkeintai stii tecnikevi prodiagrafevi asfaleivai pou iscuvcoun katav thn crhvsh tou proiovntoi

- B. Episkeuhv pou evgine apov mh exousiodothmevna sunergeiva **service**
- G. Atuchvmata, geomhnivei hv opoiadhvpote aitiva pevra tou elevgcou th **SAMSUNG**,

sumperilambanomevwn allav mh periorismevwn twv keraunwvn, tou nerouv, th fwtiavi, twv dhmosivwn anataracwvn, tou kakouv aerismouv klp.

- D. H egguvhsh authv den ephreavzei ta dikaiwvmata tou katanalwthv pou problevpontai apov thn efarmosteva eqnikhv nomogesiva pou iscuvei, ouvte ta dikaiwvmata twv katanalwtwvvn enantivon twv lianopwlhtwvvn pou aporrevcoun apov thn suvwbash pwlhsh.
- E. Se perivptwsh pou den upavrcei eqnikhv nomogesiva authv h egguvhsh qa eivnai h monadikhv kai apokleistikhv kavlyh tou katanalwthv gia kavqe zhmiav.

FOURLIS TRADE A.E.B.E.