

Digital Video Camcorder

Mini DV Digital
Video
Cassette

VP-D371(i)/D371W(i)/D372WH(i)/D375W(i)/D975W(i)

- AF** Auto Focus
- CCD** Charge Coupled Device
- LCD** Liquid Crystal Display

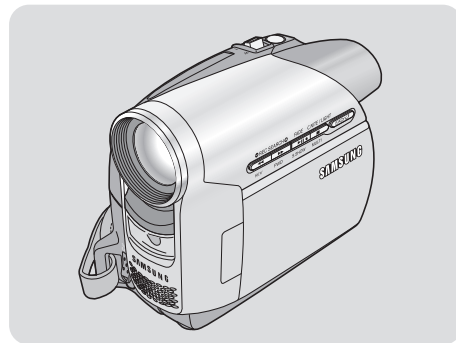

SAMSUNG

Owner's Instruction Book

Before operating the unit, please read this Instruction Book thoroughly, and retain it for future reference.

Use only approved battery packs.
Otherwise, there is a danger of overheating, fire or explosion.
Samsung is not responsible for problems occurring due to using unapproved batteries.

AD68-01227G

Contents

Notes and Safety Instructions5

Getting to Know Your Camcorder7

Features7
 Accessories Supplied with Camcorder8
 Front & Left View9
 Left Side View10
 Right & Top View11
 Rear & Bottom View12
 Remote Control (VP-D375W(i)/D975W(i) only)13

Preparation14

Using the Hand Strap & Lens Cover14
 Lithium Battery Installation15
 Using the Lithium Ion Battery Pack16
 Connecting a Power Source19
 About the Operating Modes19
 Using the QUICK MENU20
 OSD (On Screen Display) in Camera/Player Modes21
 OSD (On Screen Display) in M.Cam/M.Player Modes
 (VP-D375W(i)/D975W(i) only)22
 Turning the OSD (On Screen Display) On/Off22

Initial Setting : System Menu Setting23

Setting the Clock (**Clock Set**)23
 Setting the Wireless Remote Control Acceptance (**Remote**)
 (VP-D375W(i)/D975W(i) only)24
 Setting the Beep Sound (**Beep Sound**)25

Setting the Shutter Sound (**Shutter Sound**)
 (VP-D375W(i)/D975W(i) only)26
 Selecting the OSD Language (**Language**)27
 Viewing the Demonstration (**Demonstration**)28

Initial Setting : Display Menu Setting29

Adjusting the LCD Screen (**LCD Bright/LCD Colour**)29
 Displaying the Date/Time (**Date/Time**)30
 Setting the TV Display (**TV Display**)31

Basic Recording32

Using the Viewfinder32
 Inserting / Ejecting a Cassette32
 Various Recording Techniques33
 Making your First Recording34
 Recording with Ease for Beginners (**EASY.Q Mode**)35
 Reviewing and Searching a Recording (**REC SEARCH**)36
 Searching quickly for a desired scene (**Setting the ZERO
 MEMORY**) (VP-D375W(i)/D975W(i) only)37
Self Record using the Remote Control (**Setting the Self
 Timer**) (VP-D375W(i)/D975W(i) only)38
 Zooming In and Out39
 Using the Fade In and Out40
 Using the COLOUR NITE (**COLOUR NITE**)41
 Using the LIGHT (VP-D372WH(i)/D375W(i)/D975W(i) only) ..42

Contents

Copying Still Images from a Cassette to a Memory Card (Photo Copy)	87	Selecting the USB Device (USB Connect)	94
Marking Images for Printing (Print Mark).....	88	Installing DV Media PRO Program	95
Removing the Print Mark	88	Connecting to a PC	96
		Disconnecting the USB Cable	96
		Using the PC Camera Function.....	97
		Using the USB Streaming Function	98
		Using the removable Disk Function	98
PictBridge™ (VP-D375W(i)/D975W(i) only).....	89		
Printing Your Pictures – Using the PictBridge™	89		
Connecting To a Printer.....	89		
Selecting Images.....	90		
Setting the Number of Prints	90		
Setting the Date/Time Imprint Option	90		
Printing Images	90		
Canceling the Printing.....	90		
IEEE 1394 Data Transfer	91		
Transferring IEEE1394 (i.LINK)-DV Standard Data Connections.....	91		
Connecting to a DV Device (DVD Recorder, Camcorder, etc.) ..	91		
Connecting to a PC.....	91		
System Requirements.....	91		
Recording with a DV Connection Cable (VP-D371i/D371Wi/D372WHi/D375Wi/D975Wi only).....	92		
USB Interface (VP-D375W(i)/D975W(i) only)	93		
Using USB Interface.....	93		
Transferring a Digital Image through a USB Connection.....	93		
USB Connection Speed depending on the System.....	93		
System Requirements.....	93		
		Maintenance	99
		After Finishing a Recording.....	99
		Usable Cassette Tapes	99
		Cleaning and Maintaining the Camcorder	100
		Using Your Camcorder Abroad	101
		Troubleshooting	102
		Troubleshooting	102
		Self Diagnosis Display	102
		Self Diagnosis Display in M.Cam/M.Player Modes (VP-D375W(i)/D975W(i) only).....	103
		Setting menu items.....	105
		Specifications.....	107
		Index.....	108
		Power Sources (United Kingdom Only)	109

Notes and Safety Instructions

Notes regarding the Rotation of the LCD Screen

Please rotate the LCD Screen carefully as illustrated. Over rotation may cause damage to the inside of the hinge that connects the LCD Screen to the Camcorder.

1. Open the LCD Screen 90 degrees to the Camcorder with your finger.
2. Rotate it to the best angle to record or play.
 - If you rotate the LCD Screen 180 degrees so it is facing forward, you can close the LCD Screen with the display facing out.
 - This is convenient during playback operations.

[Note]

Refer to page 29 to adjust brightness and colour of the LCD Screen.

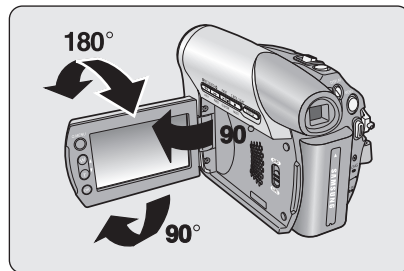

Notes regarding the LCD Screen, Viewfinder, Lens

1. Direct sunlight can damage the LCD Screen, the inside of the Viewfinder or the Lens. Take pictures of the sun only in low light conditions, such as at dusk.
2. The LCD Screen has been manufactured using high precision technology. However, there may be tiny dots (red, blue or green in colour) that appear on the LCD Screen. These dots are normal and do not affect the recorded picture in any way.
3. Do not pick up the Camcorder by holding the Viewfinder, LCD Screen or Battery Pack.
4. Applying excessive force to the Viewfinder may damage it.

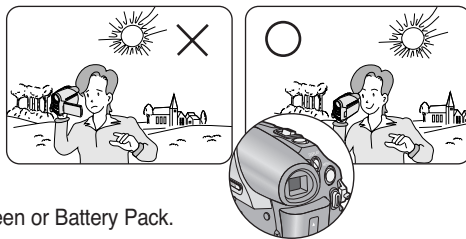

Notes regarding the Video Head Cleaning

- To ensure normal recording and a clear picture, clean the video heads regularly. If a square block-shape distorts playback, or only a blue screen is displayed, the video heads may be dirty. If this happens, clean the video heads with a dry type cleaning cassette.
- Do not use a wet-type cleaning cassette. It may damage the video heads.

Notes and Safety Instructions

Notes regarding Camcorder

- Do not leave the Camcorder exposed to high temperatures (above 60 °C or 140 °F).
For example, in a parked car in the sun or exposed to direct sunlight.
- Do not let the Camcorder get wet. Keep the Camcorder away from rain, sea water, and any other form of moisture. If the Camcorder gets wet, it may get damaged. Sometimes a malfunction due to exposure to liquids cannot be repaired.
- A sudden rise in atmospheric temperature may cause condensation to form inside the Camcorder.
 - When you move the Camcorder from a cold location to a warm location (e.g. from outside to inside during the winter.)
 - When you move the Camcorder from a cool location to a hot location (e.g. from inside to outside during the summer.)
- If the  (DEW) protection feature is activated, leave the Camcorder for at least two hours in a dry, warm room with the cassette compartment opened and the Battery Pack removed.
- To disconnect the apparatus from the mains, the plug must be pulled out from the mains socket, therefore the mains plug shall be readily operable.

Notices regarding Copyright

Television programmes, video tapes, DVD titles, films, and other programme materials may be copyrighted.

Unauthorized copying of copyrighted material may be against the law.

All the trade names and registered trademarks mentioned in this manual or other documentation provided with your Samsung product are trademarks or registered trademarks of their respective holders.

Servicing & Replacement Parts

- Do not attempt to service this Camcorder yourself.
- Opening or removing covers may expose you to dangerous voltage or other hazards.
- Refer all servicing to qualified service personnel.
- When replacement parts are required, be sure the service technician has used replacement parts specified by the manufacturer and having the same characteristics as the original part.
- Unauthorized substitutions may result in fire, electric shock or other hazards.



Correct Disposal of This Product (Waste Electrical & Electronic Equipment)

(Applicable in the European Union and other European countries with separate collection systems)

This marking shown on the product or its literature, indicates that it should not be disposed with other household wastes at the end of its working life. To prevent possible harm to the environment or human health from uncontrolled waste disposal, please separate this from other types of wastes and recycle it responsibly to promote the sustainable reuse of material resources. Household users should contact either the retailer where they purchased this product, or their local government office, for details of where and how they can take this item for environmentally safe recycling. Business users should contact their supplier and check the terms and conditions of the purchase contract. This product should not be mixed with other commercial wastes for disposal.

Getting to Know Your Camcorder

Features

- **Digital Data Transfer Function with IEEE1394**
 By incorporating the IEEE 1394 (i.LINK™: i.LINK is a serial data transfer protocol and interconnectivity system, used to transmit DV data) high speed data transport port, both moving and photo images can be transferred to a PC, making it possible to produce or edit various images.
- **USB Interface for Digital Image Data Transfer (VP-D375W(i)/D975W(i) only)**
 You can transfer images to a PC using the USB interface without an add-on card.
- **Still Image Recording on a Tape**
 Still image recording makes it possible to record a still image on a tape.
- **Mega-pixel CCD (VP-D975W(i) only)**
 Your camcorder incorporates a 1.0 mega-pixel CCD. High-resolution photo images can be recorded to a Memory card.
- **1200x Digital Zoom**
 Allows you to magnify an image up to 1200 times its original size.
- **Audio Enhancement**
 Provides more powerful sound with the Real Stereo and Audio Effect features.
- **Colour TFT LCD**
 A high-resolution colour TFT LCD gives you clean, sharp images as well as the ability to review your recordings immediately.
- **Digital Image Stabilizer (DIS)**
 The DIS compensates for any handshake, reducing unstable images particularly at high magnification.
- **Various Visual Effects**
 The Visual Effects allow you to give your films a special look by adding various special effects.
- **Back Light Compensation (BLC)**
 The BLC function compensates for a bright background behind a subject you're recording.
- **Program AE**
 The Program AE enables you to alter the shutter speed and aperture to suit the type of scene/action to be filmed.
- **High Power Zoom Lens**
 Power Zoom lens allows users to magnify the subject clearly up to X34(VP-D371(i)/D371W(i)/D372WH(i)/D375W(i) only), X26(VP-D975W(i) only)
- **Digital Still Camera Function (VP-D375W(i)/D975W(i) only)**

 - Using Memory Card, you can easily record and playback standard photo images.
 - You can transfer standard photo images on the Memory Card to your PC using the USB interface.
- **Moving Image Recording on a Memory Card (VP-D375W(i)/D975W(i) only)**
 Moving image recording makes it possible to record video onto a Memory Card.
- **MMC/SD card slot (VP-D375W(i)/D975W(i) only)**
 MMC/SD card slot is able to use MMC(Multi Media Cards) and SD cards.

Getting to Know Your Camcorder

Accessories Supplied with Camcorder

Make sure that the following basic accessories are supplied with your Digital Video Camcorder.

Basic Accessories

1. Lithium Ion Battery Pack (SB-LSM80)
2. AC Power Adapter (AA-E9 TYPE)
3. Audio/Video Cable
4. Instruction Book
5. Lithium Battery for Remote Control (VP-D375W(i)/D975W(i) only) or Clock. (TYPE: CR2025)
6. Remote Control (VP-D375W(i)/D975W(i) only)
7. USB Cable (VP-D375W(i)/D975W(i) only)
8. Software CD (VP-D375W(i)/D975W(i) only)
9. Lens Cover
10. Lens Cover Strap

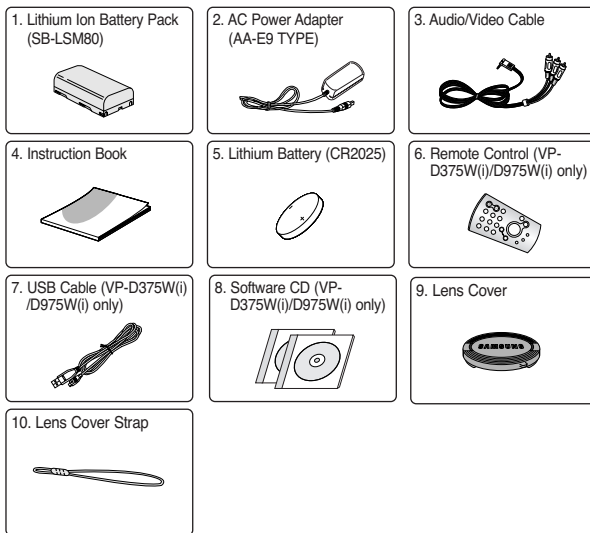

[Notes]

- The contents can vary depending on the sales region.
- Parts and accessories are available at your local Samsung dealer and service centre.

Getting to Know Your Camcorder

Front & Left View

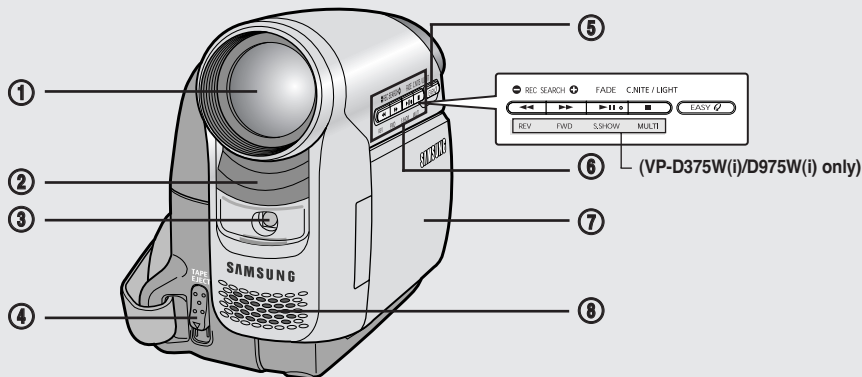

1. Lens
2. Remote Sensor (VP-D375W(i)/D975W(i) only)
3. Light (VP-D372WH(i)/D375W(i)/D975W(i) only)
4. TAPE EJECT Switch
5. EASY.Q Button ➔page 35

6. Function Buttons

Button	<Player>	<Camera>	<M.Player> (VP-D375W(i)/D975W(i) only)
◀	REW	REC SEARCH -	REV
▶▶	FF	REC SEARCH +	FWD
▶▶	PLAY/STILL	FADE	S.SHOW (SLIDE SHOW)
■	STOP	C.NITE/LIGHT (VP-D372WH(i)/D375W(i)/D975W(i) only)	MULTI (MULTI DISPLAY)

7. TFT LCD Screen

8. Internal Microphone

[Caution]

Be careful not to cover the internal microphone and lens during recording.

[Notes]

- Illustrations of VP-D375W are used in this owner's instructions.
- Although the external appearances of VP-D371(i), VP-D371W(i), VP-D372WH(i), VP-D375W(i) and VP-D975W(i) are different, they are both operated in the same way.

Getting to Know Your Camcorder

Left Side View

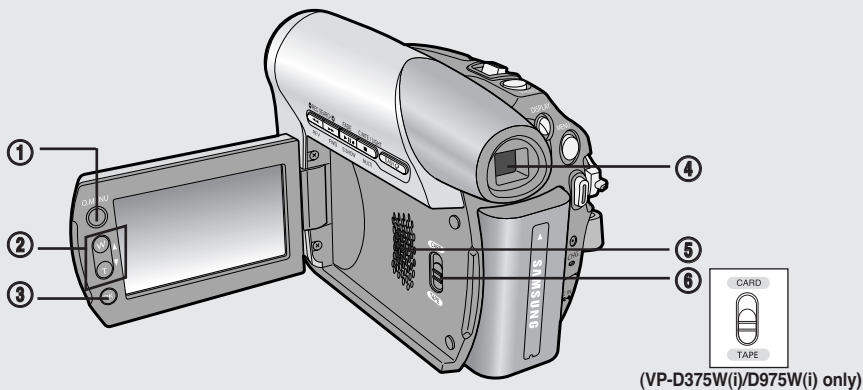

1. Q.MENU Button →page 20

2. [▲ / ▼] (W / T) Button

	W (▲)	T (▼)
MENU / Q.MENU	Move Up	Move Down
<Player>	Volume Up	Volume Down
<Camera>	Wide / Adjust MF	Tele / Adjust MF
<M.Cam> (VP-D375W(i)/D975W(i) only)	Wide / Adjust MF	Tele / Adjust MF
<M.Player> (VP-D375W(i)/D975W(i) only)	Previous	Next

3. OK Button

4. Viewfinder

5. Speaker

6. Mode Switch (CARD/TAPE)
(VP-D375W(i)/D975W(i) only)

[Note]

When you close LCD panel with the LCD screen facing out, [▲ / ▼] button function works reversely.

Getting to Know Your Camcorder



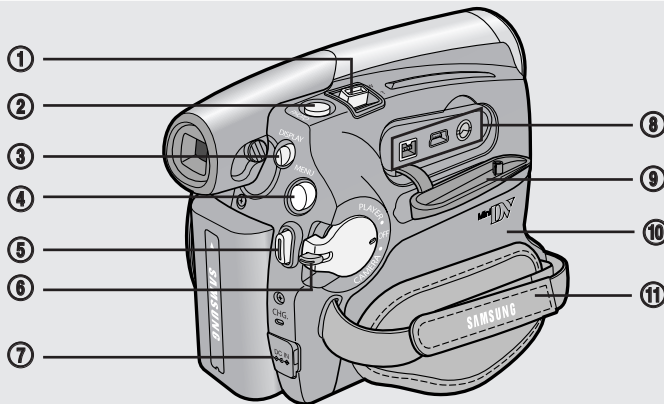

Right & Top View



- 1. Zoom Lever
- 2. PHOTO Button ↗ page 59
- 3. DISPLAY Button
- 4. MENU Button
- 5. Start/Stop Button
- 6. Power Switch
(CAMERA or PLAYER)

- 7. DC Jack
- 8. Jacks
- 9. Jack Cover
- 10. Cassette Door
- 11. Hand Strap

Jacks

VP-D371(i) /D371W(i)/ D372WH(i)	 IEEE1394	 AV Jack	
VP-D375W(i) /D975W(i)	 IEEE1394	 USB	 AV Jack

Getting to Know Your Camcorder

Rear & Bottom View

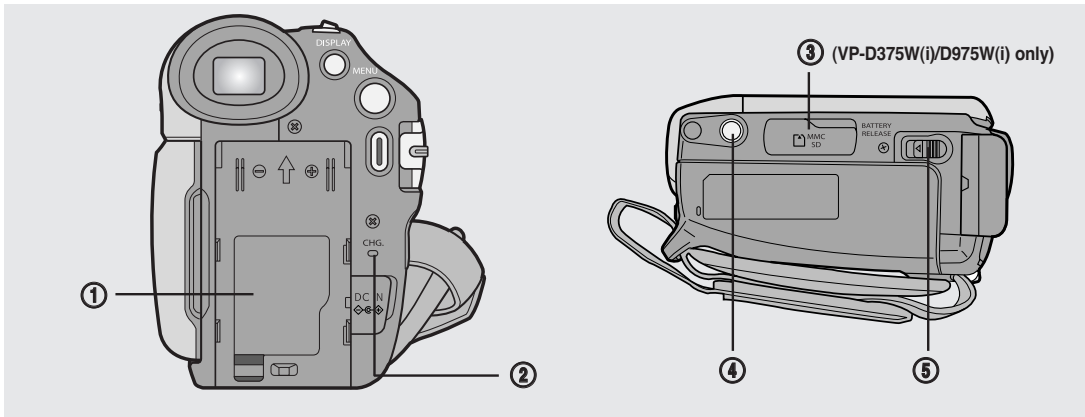

1. Lithium Battery Cover
2. Charging Indicator
3. Memory Card Slot (VP-D375W(i)/D975W(i) only)
4. Tripod Receptacle
5. Battery Release Switch

Usable Memory Cards

VP-D375W(i)/D975W(i) only



MMC/SD

Getting to Know Your Camcorder

Remote Control (VP-D375W(i)/D975W(i) only)

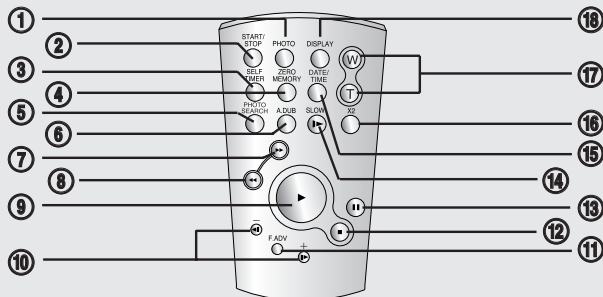

- | | |
|--------------------------------|---|
| 1. PHOTO Button ➔page 59 | 10. ◀II / II▶ (Direction) Button ➔page 61 |
| 2. START/STOP Button | 11. F. ADV Button ➔page 62 |
| 3. SELF TIMER Button ➔page 38 | 12. ■ (STOP) Button |
| 4. ZERO MEMORY Button ➔page 37 | 13. II (STILL) Button |
| 5. PHOTO SEARCH Button | 14. SLOW (II▶) Button |
| 6. A.DUB Button ➔page 23 | 15. DATE/TIME Button |
| 7. ▶▶ (FF) Button | 16. X2 Button ➔page 62 |
| 8. ◀◀ (REW) Button | 17. W/T (Zoom) Button |
| 9. ▶ (PLAY) Button | 18. DISPLAY Button |

Preparation

Using the Hand Strap & Lens Cover

It is very important to ensure that the Hand Strap has been correctly adjusted before you begin your recording.

The Hand Strap enables you to:

- Hold the Camcorder in a stable, comfortable position.
- Press the [Zoom] and [Start/Stop] button without having to change the position of your hand.

Hand Strap

Adjusting the Hand Strap

1. Insert the Hand Strap into the Hand Strap Hook on the front side of the Camcorder and pull its end through the hook.
2. Insert your hand into the Hand Strap and adjust its length for your convenience.
3. Close the Hand Strap.

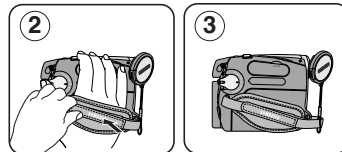
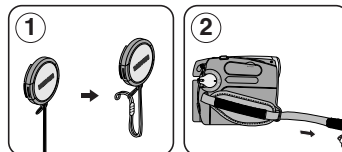
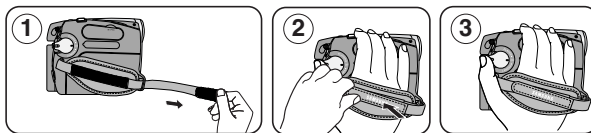

Lens Cover

Attaching the Lens Cover

1. Hook up the Lens Cover with the Lens Cover Strap as illustrated.
2. Hook up the Lens Cover Strap to the Hand Strap, and adjust it following the steps as described for the Hand Strap.
3. Close the Hand Strap.

Installing the Lens Cover after Operation

Press buttons on both sides of the Lens Cover, then attach it to the Camcorder Lens.

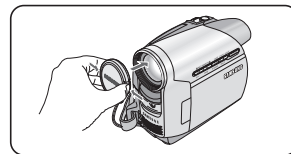

Preparation

Lithium Battery Installation

Lithium Battery Installation for the Internal Clock

1. Remove the Battery Pack from the rear of the Camcorder.
2. Open the Lithium Battery Cover on the rear of the Camcorder.
3. Position the Lithium Battery in the Lithium Battery Holder, with the positive (+) terminal face up.
Be careful not to reverse the polarity of the Battery.
4. Close the Lithium Battery Cover.

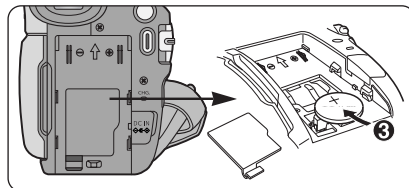

Lithium Battery Installation for the Remote Control (VP-D375W(i)/D975W(i) only)

1. Pull out the Lithium Battery Holder toward the direction of the arrow.
2. Position the Lithium Battery in the Lithium Battery Holder, with the positive (+) terminal face up.
3. Reinsert the Lithium Battery Holder.

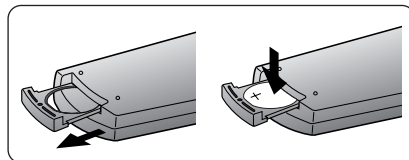

Precaution regarding the Lithium Battery

1. The Lithium Battery maintains the clock function and preset contents of the memory; even if the Battery Pack or AC Power adapter is removed.
2. The Lithium Battery for the Camcorder lasts about 6 months under normal operation from time of installation.
3. When the Lithium Battery becomes weak or dead, the date/time indicator will display <00:00 1.JAN.2007> when you set the <Date/Time> to <On>. When this occurs, replace the Lithium Battery with a new one (type CR2025).
4. There is a danger of explosion if Battery is incorrectly replaced. Replace only with the same or equivalent type.

Warning: Keep the Lithium Battery out of reach of children. Should a battery be swallowed, consult a doctor immediately.

Preparation

Using the Lithium Ion Battery Pack

- ❖ Use SB-LSM80 or SB-LSM160 Battery Pack only.
- ❖ The Battery Pack may be charged a little at the time of purchase.

Charging the Lithium Ion Battery Pack

1. Turn the [Power] switch to [OFF].
2. Attach the Battery Pack to the Camcorder.
3. Connect the AC Power adapter (AA-E9 TYPE) to a wall socket.
4. Connect the DC cable to the DC jack on the Camcorder.
 - The charging indicator will start to blink, showing that the Battery is charging.
5. Press and hold the DISPLAY button while charging and the charging status will be displayed on the LCD screen for 7 seconds.
 - The battery charge status is given as reference and is an estimation. It may differ depending on the Battery capacity and temperature.
6. When the Battery is fully charged, disconnect the Battery Pack and the AC Power Adapter from the Camcorder.
 - Even with the Power switched Off, the Battery Pack will still discharge.

Blinking time	Charging rate
Once per second	Less than 50%
Twice per second	50% ~ 75%
Three times per second	75% ~ 90%
Blinking stops and stays on	90% ~ 100%
On for a second and off for a second	Error - Reset the Battery Pack and the DC Cable

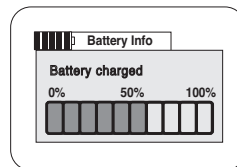

Charging, Recording Times based on Model and Battery Type.

- ❖ The continuous recording times given in the table to the right are approximations.
Actual recording time depends on usage.
- ❖ The continuous recording times in the operating instructions are measured using a fully charged Battery Pack at 77 °F (25 °C).
- ❖ Even when the Power switched Off, the Battery Pack will still discharge if it is left attached to the device.

Battery	Time	Charging time	Recording time
SB-LSM80		Approx. 1hr 20min	Approx. 1hr 20min
SB-LSM160 (Option)		Approx. 3hr	Approx. 2hr 40min

Preparation

The amount of continuous recording time available depends on;

- The type and capacity of the Battery Pack you are using.
 - Ambient temperature.
 - How often the Zoom function is used.
 - Type of use (Camcorder/Camera/With LCD Screen etc.).
- It is recommended that you have several batteries available.

Battery Level Display

The battery level display indicates the amount of power remaining in the Battery Pack.

- a. Fully charged
- b. 20~40% used
- c. 40~80% used
- d. 80~95% used
- e. Completely used (Blinking)

(The Camcorder will turn off soon, change the battery as soon as possible.)

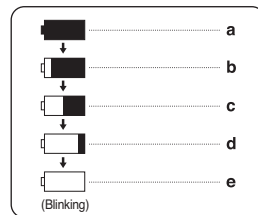

Battery Pack Management

- The Battery Pack should be recharged in an environment between 32 °F (0 °C) and 104 °F (40°C).
- The life and capacity of the Battery Pack will be reduced if it is used in temperatures below 32 °F (0 °C) or left in temperatures above 104 °F (40 °C) for a long period of time, even when it is fully recharged.
- Do not put the Battery Pack near any heat source (i.e. fire or a heater).
- Do not disassemble, apply pressure to, or heat the Battery Pack.
- Do not allow the + and – terminals of the Battery Pack to be short-circuited. It may cause leakage, heat generation, induce overheating or fire.

Preparation

Notes regarding the Battery Pack

- Please refer to the table on page 16 for approximate continuous recording time.
- The recording time is affected by temperature and environmental conditions.
- The recording time shortens dramatically in a cold environment. As the environmental temperature and conditions vary.
- The continuous recording times in the operating instructions are measured using a fully charged Battery Pack at 77 °F (25 °C). The remaining battery time may differ from the approximate continuous recording times given in the instructions.
- It is recommended you use the original Battery Pack that is available at SAMSUNG retailer.
When the Battery reaches the end of its life, please contact your local dealer.
The batteries have to be dealt with as chemical waste.
- Make sure that the Battery Pack is fully charged before starting to record.
- A brand new Battery Pack is not charged. Before using the Battery Pack, you need to charge it completely.
- Fully discharging a Lithium Ion Battery damages the internal cells.
The Battery Pack may be prone to leakage when fully discharged.
- To preserve battery power, keep your Camcorder turned off when you are not operating it.
- If your Camcorder is in <Camera> mode, and it is left in <STBY> mode without being operated for more than 5 minutes with a tape inserted, it will automatically turn itself off to protect against unnecessary battery discharge.
- Make sure that the Battery Pack is fitted firmly into place.
Do not drop the Battery Pack. Dropping the Battery Pack may damage it.

Preparation

Connecting a Power Source

- ❖ There are two types of power source that can be connected to your Camcorder.
 - The AC Power Adapter: used for indoor recording.
 - The Battery Pack: used for outdoor recording.

Using a Household Power Source

Connect to a household power source to use the Camcorder without having to worry about the battery power. You can keep the Battery Pack attached; the battery power will not be consumed.

1. Turn the **[Power]** switch to **[OFF]**.
2. Connect the AC Power adapter (AA-E9 TYPE) to a wall socket.
 - The plug and wall socket type may differ according to your resident country.
3. Connect the DC cable to the DC jack of the Camcorder.
4. Set the Camcorder to each mode by holding down the tab on the **[Power]** switch and turning it to the **[CAMERA]** or **[PLAYER]** mode.

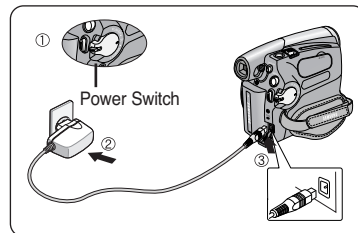

About the Operating Modes

- ❖ The operating modes are determined by the position of the **[Power]** switch and the **[Mode]** switch.
- ❖ Set the Operation Mode by adjusting **[Power]** switch and **[Mode]** switch before operating any functions.

Mode Name	<Camera Mode>	<Player Mode>	<M.Cam Mode>	<M.Player Mode>
[Power] Switch				
[Mode] Switch (VP-D375W(i)/ D975W(i) only)				

- ❖ M.Cam Mode : Memory Camera Mode / M.Player Mode : Memory Player Mode
- ❖ The <M.Cam Mode> and the <M.Player Mode> are only enabled on VP-D375W(i)/D975W(i).

Preparation

Using the QUICK MENU

- ❖ QUICK MENU is used to access camcorder functions by using the [Q.MENU] button.
- ❖ QUICK MENU provides easier access to frequently used menus without using the [MENU] button.
- ❖ Functions available using the QUICK MENU are as below:

Camera Mode

- Setting the Back Light Compensation (BLC) ➔page 57
- Setting the Digital Image Stabilizer (DIS) ➔page 56
- Programmed Automatic Exposure Modes (Program AE) ➔page 48
- Setting the White Balance (White Balance) ➔page 50
- Setting the Shutter Speed (Shutter)- Can only be operated by using the QUICK MENU ➔page 46
- Setting the Exposure (Exposure)- Can only be operated by using the QUICK MENU ➔page 46
- Setting the Focus (Focus) ➔page 47

M.Cam Mode (VP-D375W(i)/D975W(i) only)

- Setting the Back Light Compensation (BLC) ➔page 57
- Selecting the recording Photo Size (Photo Size) ➔page 75 (VP-D975W(i) only)
- Setting the White Balance (White Balance) ➔page 50
- Setting the Photo Quality (Photo Quality) ➔page 74
- Setting the Exposure (Exposure)- Can only be operated by using the QUICK MENU ➔page 46
- Setting the Focus (Focus) ➔page 47

M.Player Mode (VP-D375W(i)/D975W(i) only)

- Playing the Moving Images (MPEG) on the Memory Card (M. Play Select) ➔page 85
- Deleting Photo Images and Moving Images (Delete) ➔page 80
- Protection from accidental Erasure (Protect) ➔page 79
- Marking Images for Printing (Print Mark) ➔page 88

For example: Setting the White Balance

1. Press the [Q.MENU] button.
The quick menu list will appear.
2. Press the [▲ / ▼] button to select <White Balance>, then press the [OK] button.
3. Press the [▲ / ▼] button to select desired mode <Auto>, <Indoor>, <Outdoor> or <Custom WB>, then press the [OK] button.
4. To exit, press the [Q.MENU] button.

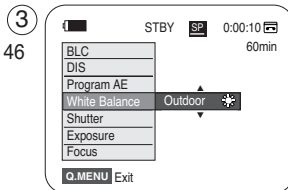
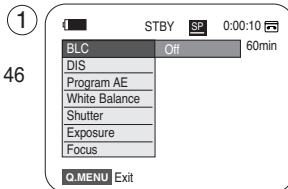
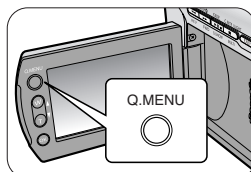

<When the Outdoor option was selected>

Preparation

OSD (On Screen Display) in Camera/Player Modes

1. Battery Level ➔page 17
2. Visual Effects Mode ➔page 52
EASY.Q ➔page 35
16:9 Wide ➔page 54
3. DIS ➔page 56
4. Program AE ➔page 48
5. White Balance Mode ➔page 50
6. Shutter Speed ➔page 46
7. Exposure ➔page 46
8. Manual Focus ➔page 47
9. Date/Time ➔page 30
10. Zoom Position ➔page 39
11. COLOUR NITE ➔pages 41
12. USB ➔page 96
(VP-D375W(i)/D975W(i) only)
13. Remote ➔page 24
(VP-D375W(i)/D975W(i) only)
14. WindCut Plus ➔page 44
15. BLC (Back Light Compensation) ➔page 57
16. Light ➔page 42 (VP-D372WH(i)/D375W(i)/D975W(i) only)
17. Real Stereo ➔page 45
18. Audio Mode ➔page 43
19. Remaining Tape (measured in minutes)
20. Tape Counter
21. Zero Memory ➔page 37
(VP-D375W(i)/D975W(i) only)
22. Record Speed Mode ➔page 43
23. Operating Mode
24. Self Timer ➔page 38
(VP-D375W(i)/D975W(i) only)
25. Still image recording ➔page 59
26. Tele Macro ➔page 55
27. Dubbed Audio Playback ➔page 64
28. DEW ➔page 6
29. Volume Control ➔page 60
30. Message Line ➔page 103
31. Warning Indicator ➔page 103
32. DV IN (DV data transfer mode) ➔page 92 (VP-D371i/D371Wi/D372WHi/D375Wi/D975Wi only)
33. AV IN ➔page 69 (VP-D371i/D371Wi/D372WHi/D375Wi/D975Wi only)
34. Voice+ Indicator ➔page 67
35. Audio Dubbing ➔page 63
(VP-D375W(i)/D975W(i) only)

OSD in Camera Mode

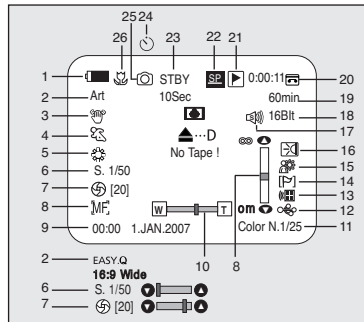

OSD in Player Mode

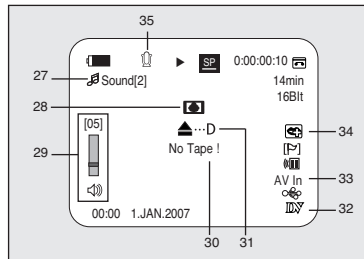

[Notes]

- OSD (On Screen Display) items shown here are based on model VP-D375W.
- The above screen is an example for explanation; it is different from the actual display.

Preparation

OSD (On Screen Display) in M.Cam/M.Player Modes (VP-D375W(i)/D975W(i) only)

1. Photo Quality ➔page 74
2. CARD (Memory Card) Indicator
3. Image Counter (Total number of recordable photo images)
4. Image Recording and Loading Indicator
5. Erase Protection Indicator ➔page 79
6. Print Mark ➔page 88
7. Folder Number - File Number ➔page 76
8. Photo Size ➔page 75 (VP-D975W(i) only)
9. Slide Show ➔page 78

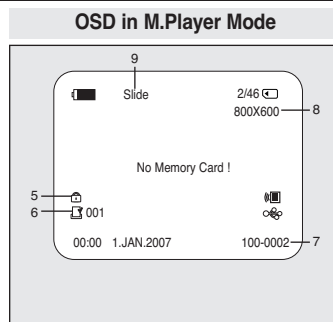
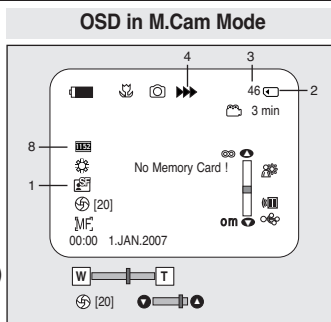

[Notes]

- OSD (On Screen Display) items shown here are based on model VP-D375W.
- The above screen is an example for explanation; It is different from the actual display.

Turning the OSD (On Screen Display) On/Off

- ❖ You can switch the display mode of the on-screen information to on or off by pressing the button.

Turning OSD On/Off

Press the [DISPLAY] button.

- Each press of the button toggles the OSD function on and off.
- When you turn the OSD off,
 - In **<Camera Mode>**: The STBY, REC modes are always displayed on the screen, even when the OSD is turned off.
 - In **<Player Mode>**: When you press any Function Button, it is displayed on the OSD for 3 seconds before it turns off.

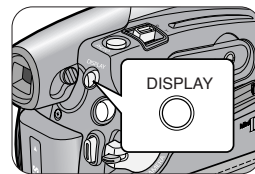

Turning the Date/Time On/Off

To turn the Date/Time on or off, access the menu and change the **<Date/Time>** mode. ➔page 30

Initial Setting : System Menu Setting

Setting the Clock (Clock Set)

- ❖ Clock setup works in <Camera>/<Player>/<M.Cam>/<M.Player> modes. ➔page 19
- ❖ The Date/Time is automatically recorded onto a tape. Before recording, please set the <Date/Time>. ➔page 30

1. Set the [Power] switch to [CAMERA] or [PLAYER].
2. Set the [Mode] switch to [TAPE] or [CARD]. (VP-D375W(i)/D975W(i) only)
3. Press the [MENU] button.
 - The menu list will appear.
4. Press the [▲ / ▼] button to select <System>, then press the [OK] button.
5. Press the [▲ / ▼] button to select <Clock Set>, then press the [OK] button.
 - The year will be highlighted first.
6. Press the [▲ / ▼] button to set current <Year>, then press the [OK] button.
 - The month will be highlighted.
7. You can set the month, day, hour and minute following the same procedure after setting the year.
8. Press the [OK] button after setting the minutes.
 - A message <Complete !> is displayed.
 - To adjust the clock, select the Year, Month, Day, Hour or Min by pressing the [OK] button, then press the [▲ / ▼] button to set respective values.
9. To exit, press the [MENU] button.

[Notes]

- After the Lithium Battery loses its charge (after about 6 months), the date/time appears on the screen as <00:00 1.JAN.2007>.
- You can set the year up to 2037.
- If the Lithium Battery is not installed, any inputted data will not be backed up.

Displays in this manual

- OSD illustrations of VP-D375W are used in this manual.
- Some of the OSD in this manual may differ slightly from the actual items of your camcorder.

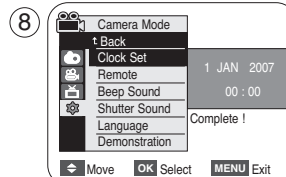
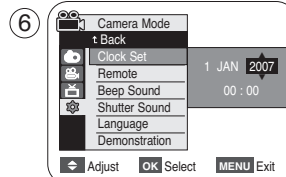
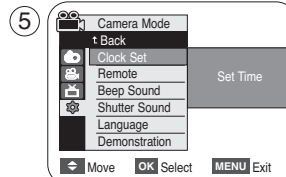
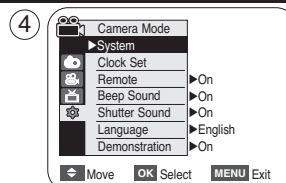

Initial Setting : System Menu Setting

Setting the Wireless Remote Control Acceptance (Remote) (VP-D375W(i)/D975W(i) only)

- ❖ The Remote function works in <Camera>/<Player>/<M.Cam>/ <M.Player> modes.
↳ page 19
- ❖ The Remote function allows you to enable or disable the remote control for use with the Camcorder.

1. Set the **[Power]** switch to **[CAMERA]** or **[PLAYER]**.
2. Set the **[Mode]** switch to **[TAPE]** or **[CARD]**.
3. Press the **[MENU]** button.
 - The menu list will appear.
4. Press the **[▲ / ▼]** button to select <System>, then press the **[OK]** button.
5. Press the **[▲ / ▼]** button to select <Remote>, then press the **[OK]** button.
6. Press the **[▲ / ▼]** button to select <On> or <Off>, then press the **[OK]** button.
7. To exit, press the **[MENU]** button.

[Note]

If you set the <Remote> to <Off> in the menu and try to use it, the remote control icon (📡) will blink for 3 seconds on the LCD Screen and then disappear.

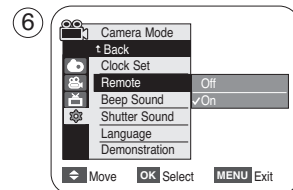
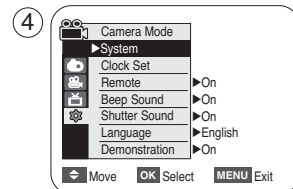
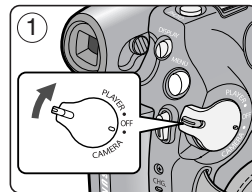

Initial Setting : System Menu Setting

Setting the Beep Sound (Beep Sound)

- ❖ The Beep Sound function works in <Camera>/<Player>/<M.Cam>/<M.Player> modes.
 ↳ page 19
- ❖ You can turn the Beep Sound on or off, when on, each press of a button sounds a beep.

1. Set the **[Power]** switch to **[CAMERA]** or **[PLAYER]**.
2. Set the **[Mode]** switch to **[TAPE]** or **[CARD]**. (VP-D375W(i)/D975W(i) only)
3. Press the **[MENU]** button.
 - The menu list will appear.
4. Press the **[▲ / ▼]** button to select <System>, then press the **[OK]** button.
5. Press the **[▲ / ▼]** button to select <Beep Sound>, then press the **[OK]** button.
6. Press the **[▲ / ▼]** button to select <On> or <Off>, then press the **[OK]** button.
7. To exit, press the **[MENU]** button.

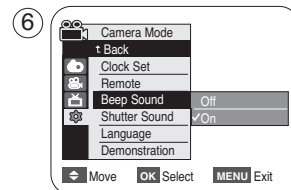
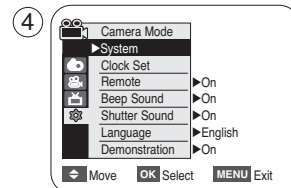
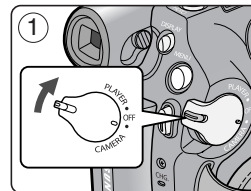

Initial Setting : System Menu Setting

Setting the Shutter Sound (Shutter Sound) (VP-D375W(i)/D975W(i) only)

- ❖ The Shutter Sound function works in <Camera>/<Player>/<M. Cam> modes. ➡ page 19
- ❖ You can turn the Shutter Sound on or off, when on, with each press of the [PHOTO] button, the Shutter will sound.

1. Set the [Power] switch to [CAMERA] or [PLAYER].
2. If the [Power] switch to [CAMERA], set the [Mode] switch to [TAPE] or [CARD].
If the [Power] switch to [PLAYER], set the [Mode] switch to [TAPE].
3. Press the [MENU] button.
 - The menu list will appear.
4. Press the [▲ / ▼] button to select <System>, then press the [OK] button.
5. Press the [▲ / ▼] button to select <Shutter Sound>, then press the [OK] button.
6. Press the [▲ / ▼] button to select <On> or <Off>, then press the [OK] button.
7. To exit, press the [MENU] button.

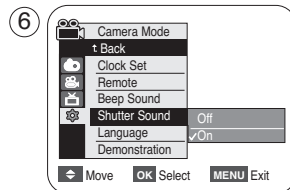
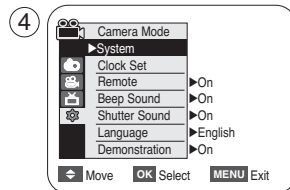
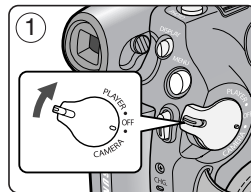

Initial Setting : System Menu Setting

Selecting the OSD Language (Language)

- ❖ The Language function works in <Camera>/<Player>/<M.Camera>/<M.Player> modes.
↳ page 19
- ❖ You can select the desired language to display the menu screen and the messages.

1. Set the [Power] switch to [CAMERA] or [PLAYER].
2. Set the [Mode] switch to [TAPE] or [CARD]. (VP-D375W(i)/D975W(i) only)
3. Press the [MENU] button.
 - The menu list will appear.
4. Press the [▲ / ▼] button to select <System>, then press the [OK] button.
5. Press the [▲ / ▼] button to select <Language>, then press the [OK] button.
 - The available language options are listed.
 - English / Français / Español / Deutsch / Italiano / Português / Polski / Nederlands / Magyar / Svenska / 中文 / ไทย / العربية / فارسي / Русский / Українська / 한국어 / Suomi / Türkçe / Norwegian / Danish
6. Press the [▲ / ▼] button to select the desired OSD language, then press the [OK] button.
 - The OSD language is refreshed in the selected language.
7. To exit, press the [MENU] button.

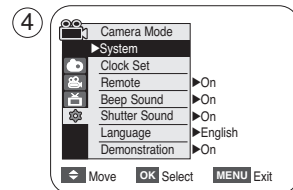
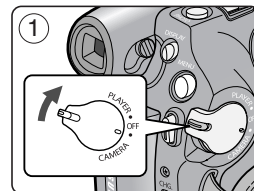

[Notes]

- The word <Language> in the menu is always indicated in English.
- Language options may be changed without prior notice.

Initial Setting : System Menu Setting

Viewing the Demonstration (Demonstration)

- ❖ The Demonstration function may only be used in the <Camera> mode without a tape inserted in the Camcorder. ➔page 19
- ❖ Before you begin: Make sure that there is no tape inserted in the Camcorder. ➔page 32
- ❖ Demonstration automatically shows you the major functions that are included with your Camcorder so that you may use them more easily.
- ❖ The Demonstration operates repeatedly until the Demonstration mode is switched Off.

1. Set the [Power] switch to [CAMERA].
2. Set the [Mode] switch to [TAPE]. (VP-D375W(i)/D975W(i) only)
3. Press the [MENU] button.
 - The menu list will appear.
4. Press the [▲ / ▼] button to select <System>, then press the [OK] button.
5. Press the [▲ / ▼] button to select <Demonstration>, then press the [OK] button.
6. Press the [▲ / ▼] button to select <On>, then press the [OK] button.
7. Press the [MENU] button.
 - The Demonstration will begin.
8. To quit the Demonstration, press the [MENU] button.

[Notes]

- The Demonstration function is automatically activated when the Camcorder is left idle for more than 10 minutes after switching to the <Camera> mode (if no tape is inserted in the Camcorder).
- If you press other buttons (FADE, C.NITE, EASY.Q) during the Demonstration mode, the demonstration stops temporarily and resumes 10 minutes later if you do not operate any other functions.

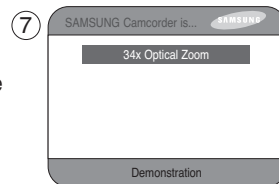
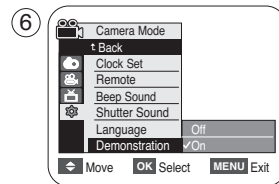
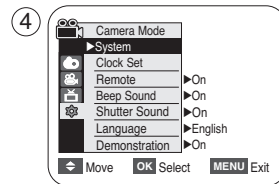
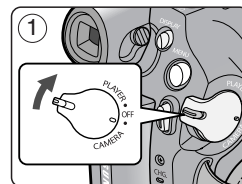

Initial Setting : Display Menu Setting

Adjusting the LCD Screen (LCD Bright/LCD Colour)

- ❖ Adjusting the LCD Screen works in <Camera>/<Player>/<M.Cam>/<M.Player> modes.
 ↳ page 19
- ❖ Your Camcorder is equipped with a 2.5 inch (VP-D371(i) only) / 2.7 inch wide (VP-D371W(i)/D372WH(i)/D375W(i)/D975W(i) only) colour Liquid Crystal Display (LCD) Screen, which enables you to view what you are recording or playing back directly.
- ❖ Depending on the conditions under which you are using the Camcorder (indoors or outdoors for example), you can adjust;
 - <LCD Bright>
 - <LCD Colour>

1. Set the [Power] switch to [CAMERA] or [PLAYER].
2. Set the [Mode] switch to [TAPE] or [CARD]. (VP-D375W(i)/D975W(i) only)
3. Press the [MENU] button.
 - The menu list will appear.
4. Press the [▲ / ▼] button to select <Display>, then press the [OK] button.
5. Press the [▲ / ▼] button to select the item you want to adjust <LCD Bright> or <LCD Colour>, then press the [OK] button.
6. Press the [▲ / ▼] button to adjust the value of the selected item <LCD Bright> or <LCD Colour>, then press the [OK] button.
 - You can set values for <LCD Bright> and <LCD Colour> between <0> ~ <35>.
7. To exit, press the [MENU] button.
 - Adjusting the LCD Screen does not affect the brightness and colour of the image to be recorded.

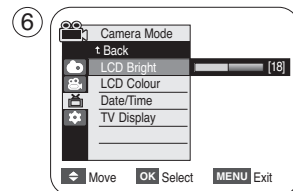
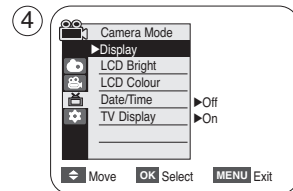
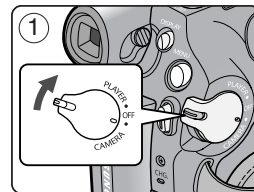

Initial Setting : Display Menu Setting

Displaying the Date/Time (Date/Time)

- ❖ The Date/Time function works in <Camera>/<Player>/<M.Cam>/<M.Player> modes.
↳ page 19
- ❖ The date and time are automatically recorded on a special data area of the tape.

1. Set the [Power] switch to [CAMERA] or [PLAYER].
2. Set the [Mode] switch to [TAPE] or [CARD]. (VP-D375W(i)/D975W(i) only)
3. Press the [MENU] button.
 - The menu list will appear.
4. Press the [▲ / ▼] button to select <Display>, then press the [OK] button.
5. Press the [▲ / ▼] button to select <Date/Time>, then press the [OK] button.
6. Press the [▲ / ▼] button to select the display type of the Date/Time, then press the [OK] button.
 - Display type of the Date/Time: <Off>, <Date>, <Time>, <Date&Time>.
7. To exit, press the [MENU] button.

[Notes]

- The Date/Time will read <00:00 1.JAN.2007> in the following conditions.
 - During playback of a blank section of a tape.
 - If the tape was recorded before setting the clock function in the Camcorder.
 - When the Lithium Battery becomes weak or dead.
- Before you use the <Date/Time> function, you must set the clock. ↳ page 23

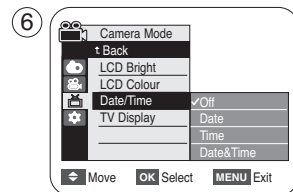
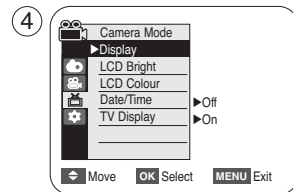
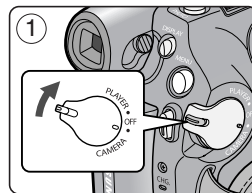

Initial Setting : Display Menu Setting

Setting the TV Display (TV Display)

❖ The TV Display function works in <Camera>/<Player>/<M.Cam>/<M.Player> modes.

↳page 19

❖ You can select the output path of the OSD (On Screen Display).

- <Off>: The OSD appears in the LCD Screen and Viewfinder only.

- <On>: The OSD appears in the LCD Screen, Viewfinder and TV.

(Connecting to a TV ↳pages 65~67)

- Use the [DISPLAY] button to turn the OSD on/off on the LCD Screen/Viewfinder/TV.

1. Set the [Power] switch to [CAMERA] or [PLAYER].

2. Set the [Mode] switch to [TAPE] or [CARD]. (VP-D375W(i)/D975W(i) only)

3. Press the [MENU] button.

■ The menu list will appear.

4. Press the [▲ / ▼] button to select <Display>, then press the [OK] button.

5. Press the [▲ / ▼] button to select <TV Display>, then press the [OK] button.

6. To activate TV Display function, press the [▲ / ▼] button to select <On> or <Off>, then press the [OK] button.

7. To exit, press the [MENU] button.

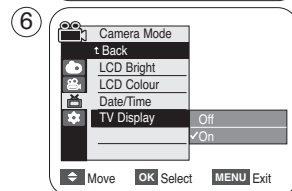
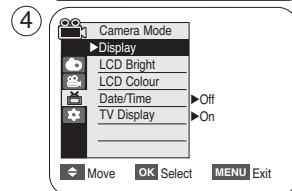
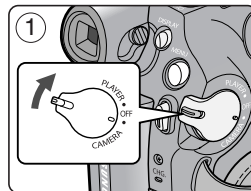

Basic Recording

Using the Viewfinder

You can view pictures through the viewfinder to avoid running down the battery, or to see correct images when the picture on the LCD screen is poor.

- ❖ In the **[PLAYER]** mode, the Viewfinder will work when the LCD Screen is closed.
- ❖ In the **[CAMERA]** mode, the Viewfinder will work when the LCD Screen is closed or rotated counterclockwise 180°.

Adjusting the Focus

The focus adjustment knob of the Viewfinder enables individuals with vision problems to see clearer images.

1. Close the LCD Screen.
2. Use the Focus adjustment Knob of the Viewfinder to focus the picture.

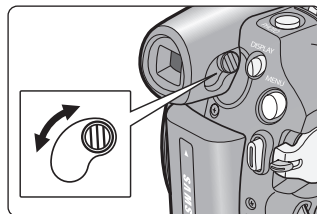

[Caution]

Do not lift the camcorder with holding the viewfinder or LCD screen. It can be a cause of sudden fall.

[Note]

Viewing the sun or any strong light source through the Viewfinder for a prolonged period may be harmful, or cause temporary impairment.

Inserting / Ejecting a Cassette

- ❖ When inserting a tape or closing the cassette compartment, do not apply excessive force, as it may cause a malfunction.
 - ❖ Do not use any tape other than Mini DV cassettes.
1. Connect a power source and slide the **[TAPE EJECT]** switch.
 - The cassette door opens automatically.
 2. Insert a tape into the cassette compartment with the tape window facing outward and the protection tab toward the top. (**Inserting a Cassette**)
 - Remove the cassette tape, which is automatically ejected by pulling the cassette out. (**Ejecting a Cassette**)
 3. Press the area marked **[PUSH]** on the cassette door until it clicks into place.
 - The cassette is loaded automatically.
 4. Close the cassette door.

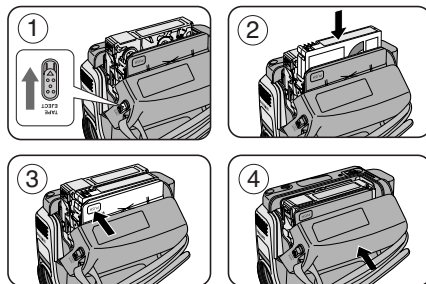

Basic Recording

Various Recording Techniques

♣ In some situations different recording techniques may be required.

1. General recording.

2. Downward recording.

Making a recording with a top view of the LCD Screen.

3. Upward recording.

Making a recording viewing the LCD Screen from below.

4. Self recording.

Making a recording viewing the LCD Screen from the front.

5. Recording with the Viewfinder.

In circumstances where it is difficult to use the LCD Screen, the Viewfinder can be used as a convenient alternative.

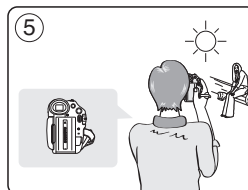
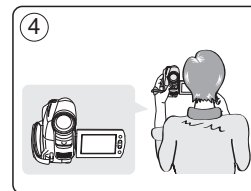
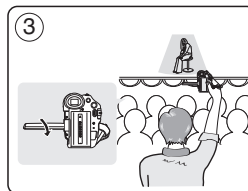
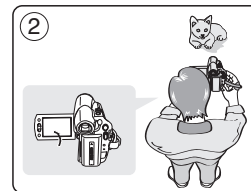
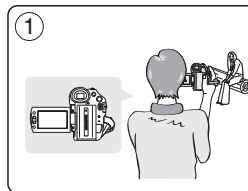

[Note]

Please rotate the LCD Screen carefully as excessive rotation may cause damage to the inside of the hinge that connects the LCD Screen to the Camcorder.

Basic Recording

Making your First Recording

1. Connect a power source to the Camcorder. ➔page 19
(A Battery pack or a AC Power adapter)
Insert a cassette. ➔page 32
2. Remove the Lens Cover.
3. Set the **[Power]** switch to **[CAMERA]**.
 - Open the LCD Screen.
 - Set the **[Mode]** switch to **[TAPE]**.
(VP-D375W(i)/D975W(i) only)
Make sure that **<STBY>** is displayed.
 - If the write protection tab of the cassette is open (set to save), **<STOP>** and **<Protection!>** will be displayed. Release the write protection tab to record.
 - Make sure the image you want to record appears on the LCD Screen or Viewfinder.
 - Make sure the Battery Level indicates that there is enough remaining power for your expected recording time.
 - You can select a Record Mode of your choice. ➔page 43
4. To start recording, press the **[Start/Stop]** button.
 - **<REC>** is displayed on the LCD Screen.

To stop recording, press the **[Start/Stop]** button again.

 - **<STBY>** is displayed on the LCD Screen.

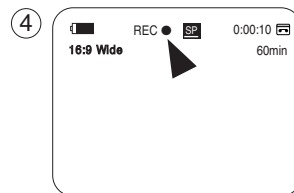
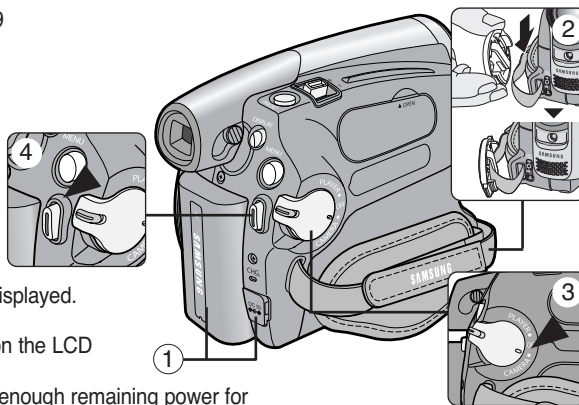

[Note]

Detach the Battery Pack when you finish the recordings to prevent unnecessary battery power consumption.

Basic Recording

Recording with Ease for Beginners (EASY.Q Mode)

- ❖ The EASY.Q function works only in <Camera> mode. ➔page 19
- ❖ The EASY.Q function allows a beginner to easily make good recordings.

1. Set the **[Power]** switch to **[CAMERA]**.
2. Set the **[Mode]** switch to **[TAPE]**. (VP-D375W(i)/D975W(i) only)
3. By pressing the **[EASY.Q]** button, all functions on the Camcorder will be set to off and the recording settings will be set to the following basic modes:
 - The words <EASY.Q> and <DIS (👉)> are displayed at the same time.
4. Press the **[Start/Stop]** button to start recording.
 - Recording will begin using the basic automatic settings.
5. Press the **[EASY.Q]** button again in the STBY mode and then turn the EASY.Q mode off.
 - The EASY.Q function will not turn off while you are recording.
 - The Camcorder will return to the settings that were set prior to activating EASY.Q mode.

[Notes]

■ Unavailable buttons during operation

During operation EASY.Q, the following buttons are unavailable because the items are automatically set. The corresponding messages may appear if unavailable operations are attempted.

- MENU button
 - C.NITE button
 - Q.MENU button
- The EASY.Q mode settings are deleted when the Battery Pack is removed from the Camcorder and must be reset when the Battery Pack is replaced.
- Taking a still image using the **[PHOTO]** button while EASY.Q is set releases the DIS function.

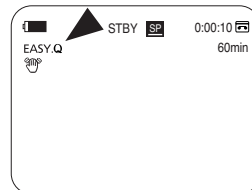
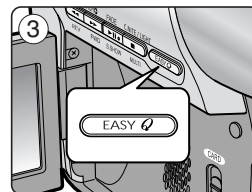
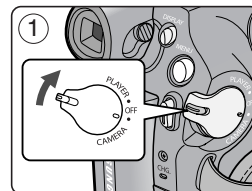

Basic Recording

Reviewing and Searching a Recording (REC SEARCH)

- ❖ The REC SEARCH function works only in <Camera> mode. ➤page 19
- ❖ Used to review previously recorded images or to find a point to record a new image in the STBY mode.

Record Search (REC SEARCH)

1. Set to STBY mode by pressing **[Start/Stop]** button.
2. **[REC SEARCH -]** enables you to play the recording backwards and **[REC SEARCH +]** enables you to play it forwards, as long as you keep each button pressed down.
 - If you press the **[REC SEARCH -]** button in STBY mode, your Camcorder will play in reverse for 3 seconds and return to the original position automatically.

[Notes]

- Mosaic shaped distortion may appear on the screen while in Record Search mode.
- Pressing **[Start/Stop]** button after REC SEARCH will overwrite the images recorded after that point.

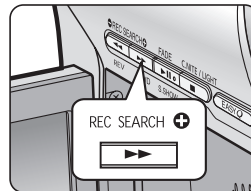
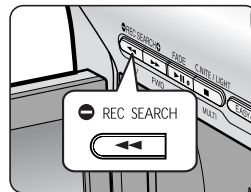

When a cassette is loaded and the Camcorder is left in the STBY mode for more than 5 minutes without being used, it will switch off automatically.

To use it again, press the **[Start/Stop]** button or set the **[Power]** switch to **[OFF]** and then back to **[CAMERA]**. This auto power off feature is designed to save battery power.

Basic Recording

Searching quickly for a desired scene (Setting the ZERO MEMORY) (VP-D375W(i)/D975W(i) only)

- ❖ The ZERO MEMORY function works in both <Camera> and <Player> modes. ➡page 19
- ❖ You can mark a point on a tape that you want to return to following playback.

1. Set the [Power] switch to [CAMERA] or [PLAYER].
2. Set the [Mode] switch to [TAPE].
3. Press the [ZERO MEMORY] button on the remote control before the recording or during playback at the point where you wish to return.
 - The time code is changed to a tape counter that is set to ZERO MEMORY with the <▶ 0:00:00> (ZERO MEMORY indicator).
 - If you want to cancel the ZERO MEMORY function, press the [ZERO MEMORY] button again.
4. Finding the zero position.
 - When you have finished playback, fast forward or rewind the tape in stop mode. The tape stops automatically when it reaches the zero position.
 - When you have finished recording, set the [Power] switch to [PLAYER] and press the [◀◀ (REW)] button. The tape stops automatically when it reaches the zero position.
5. The tape counter with the <▶> (ZERO MEMORY indicator) disappears from the display and the tape counter is changed to the time code.

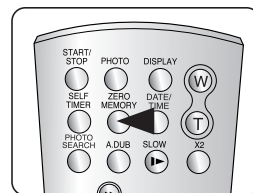
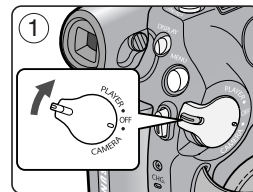

[Notes]

- In the following situations, ZERO MEMORY mode may be canceled automatically:
 - At the end of the section marked with the ZERO MEMORY function.
 - When the tape is ejected.
 - When you remove the Battery Pack or power supply.
- The ZERO MEMORY may not function correctly where there is a break between recordings on the tape.

Basic Recording

Self Record using the Remote Control (Setting the Self Timer) (VP-D375W(i)/D975W(i) only)

- ❖ The SELF TIMER function works only in <Camera> mode. ➔page 19
- ❖ When you use the SELF TIMER function on the remote control, the recording begins automatically in 10 seconds.

1. Set the [Power] switch to [CAMERA].
2. Set the [Mode] switch to [TAPE].
3. Press the [SELF TIMER] button until the appropriate indicator is displayed.
4. Press the [Start/Stop] button to start the timer.
 - SELF TIMER starts counting down from 10 with a beep sound.
 - If you want to cancel the SELF TIMER function before recording, press the [SELF TIMER] button.
5. Press the [Start/Stop] button again when you wish to stop recording.

[Notes]

- Do not obstruct the remote control sensor by putting obstacles between the remote control and Camcorder.
- The remote control range is 4 ~5m (13 ~17 ft).
- The effective remote control angle is up to 30 degrees left /right from the centre line.
- Using a tripod (not supplied) is recommended for delayed recording.

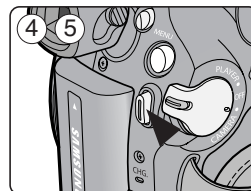
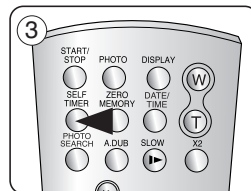
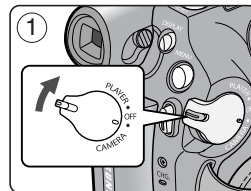

Basic Recording

Zooming In and Out

- ❖ The Zoom function works in both <Camera> and <M.Cam> modes. ➡page 19
- ❖ Zooming is a recording technique that lets you change the size of the subject in a scene.
- ❖ You can zoom using variable zoom speeds.
- ❖ Use these features for different shots. Please note that over-use of the Zoom feature can lead to unprofessional looking results and a reduction of battery usage time.

1. Press the **[W / T]** button or move **[Zoom]** lever slightly for a gradual zoom, move it further for a high-speed zoom.
 - Your zooming is monitored on the OSD.
2. **[T]** (Telephoto) side: Subject appears closer.
3. **[W]** (Wide angle) side: Subject appears farther away.
 - You can record a subject that is about 10mm (about 0.5 inch) away from the lens surface in the Wide position.

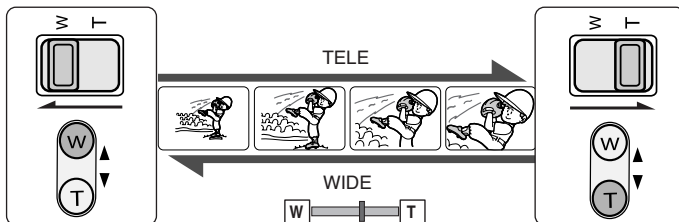
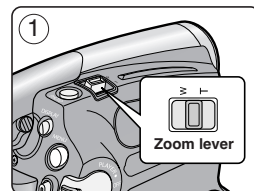
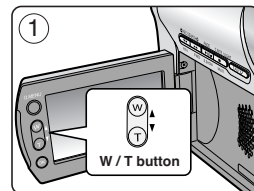

Basic Recording

Using the Fade In and Out

- ❖ The Fade function works only in <Camera> mode. → page 19
- ❖ You can give your recording a professional look by using special effects such as fade in at the beginning of a sequence or fade out at the end of a sequence.

To Start Recording

1. Set the [Power] switch to [CAMERA].
2. Set the [Mode] switch to [TAPE]. (VP-D375W(i)/D975W(i) only)
3. Before recording, press and hold the [FADE] button.
 - The picture and sound gradually disappear (fade out).
4. Press the [Start/Stop] button and at the same time release the [FADE] button.
 - Recording starts and the picture and sound gradually appear (fade in).

To Stop Recording

5. When you wish to stop recording, press and hold the [FADE] button.
 - The picture and sound gradually disappear (fade out).
6. When the picture has disappeared, press the [Start/Stop] button to stop recording.

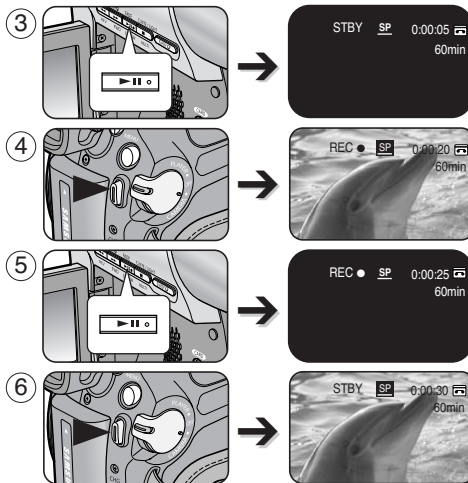

- Fade Out
(Approx. 4 seconds)
- Fade In
(Approx. 4 seconds)

Press and hold the [FADE] button

a. Fade Out

Gradual disappearance



Gradual appearance

b. Fade In

Release the [FADE] button

Basic Recording

Using the COLOUR NITE (COLOUR NITE)

- ❖ COLOUR NITE function works only in <Camera> mode. ➔page 19
- ❖ You can take a shot of an object in slow motion by controlling the shutter speed, or a brighter image in dark places without a compromise in colours.
- ❖ Please disable 16:9 Wide mode to use the COLOUR NITE function. ➔page 54

1. Set the [Power] switch to [CAMERA].
2. Set the [Mode] switch to [TAPE]. (VP-D375W(i)/D975W(i) only)
3. Press the [C.NITE] button.
4. Each time you press the [C.NITE] button, shutter speed is changed to;
 - ▶ <Color N. 1/25>, <Color N. 1/13> and <OFF>. (VP-D371(i)/D371W(i) only)
 - ▶ <Color N. 1/25>, <Color N. 1/13>, <Color N. 1/13(☒)> and <OFF>. (VP-D372WH(i)/D375W(i)/D975W(i) only)

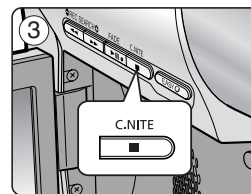

<VP-D371(i)/D371W(i) only>

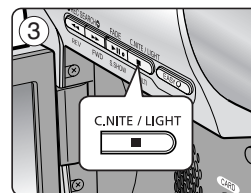

<VP-D372WH(i)/D375W(i)/D975W(i) only>

[Notes]

- The COLOUR NITE will not turn on or off while you are recording.
- When using the COLOUR NITE, the image takes on a slow motion like effect.
- When using COLOUR NITE, the focus adjusts slowly and white dots may appear on the screen. This is not a defect.
- COLOUR NITE is not available while DIS, Photo image recording or EASY.Q is in use.
- COLOUR NITE function is not available as following functions.
; 16:9 Wide, Program AE, Shutter, Exposure, Digital Zoom, Mosaic, Mirror, Emboss2 and Pastel2
- If DIS is set, COLOUR NITE mode will be released.



Basic Recording

Using the LIGHT (VP-D372WH(i)/D375W(i)/D975W(i) only)

- ❖ LIGHT function works only in <Camera> mode. ➡page 19
- ❖ The LIGHT enables you to record a subjects in dark places without sacrificing colour.
- ❖ The LIGHT can be used with the COLOUR NITE function only.
- ❖ Please disable 16:9 Wide mode to use this function. ➡page 54

1. Set the [Power] switch to [CAMERA].
2. Set the [Mode] switch to [TAPE].
3. Press the [LIGHT] button until <Color N. 1/13(☒)> appears.

[Notes]

- The LIGHT will not turn on or off while you are recording.
- The range of the LIGHT is limited. (up to 6.6ft (2m))
- 16:9 Wide mode is not available in the LIGHT mode.

[Warning]

- The LIGHT can become extremely hot.
- Do not touch it while in operation or soon after turning it off, otherwise serious injury may result.
- Do not place the Camcorder into the carrying case immediately after using the LIGHT, since it remains extremely hot for some time.
- Do not use near flammable or explosive materials.

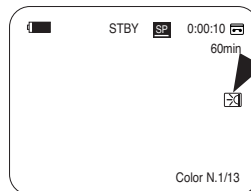
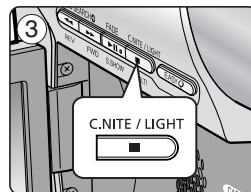
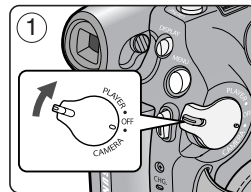

Advanced Recording

Selecting the Record Mode & Audio Mode

- ❖ The Record Mode function works in both <Camera> and <Player> (DV IN or AV IN (VP-D371i/D371Wi/D372WHi/D375Wi/D975Wi only)) modes. ➔page 19
 - ❖ This Camcorder records and plays back in SP (standard play) mode and in LP (long play) mode.
 - <SP> (standard play): This mode permits 60 minutes of recording time with a DVM60 tape.
 - <LP> (long play): This mode permits 90 minutes of recording time with a DVM60 tape.
 - ❖ The Audio Mode function works in both <Camera> and <Player> modes. ➔page 19
 - ❖ This Camcorder records sound in two ways. (12Bit, 16Bit)
 - <12Bit>: You can record two 12Bit stereo sound tracks. The original stereo sound can be recorded onto the Main (Sound1) track. Additional stereo sound can be dubbed onto the Sub (Sound2) track.
 - <16Bit>: You can record one high quality stereo soundtrack using 16Bit recording mode. Audio dubbing is not possible when using this mode.
1. Set the [Power] switch to [CAMERA] or [PLAYER].
 2. Set the [Mode] switch to [TAPE]. (VP-D375W(i)/D975W(i) only)
 3. Press the [MENU] button.
 4. Press the [▲ / ▼] button to select <Record>, then press the [OK] button.
 5. Press the [▲ / ▼] button to select <Rec Mode> or <Audio Mode>, then press the [OK] button.
 6. Press the [▲ / ▼] button to select the desired record mode or audio mode, then press the [OK] button.
 - Record mode can be set to <SP> or <LP>.
 - Audio mode can be set to <12Bit> or <16Bit>.
 7. To exit, press the [MENU] button. The selected icon is displayed.
 - When <12Bit> is selected, no <12Bit> indication is displayed.

[Notes]

- We recommend that you use this Camcorder to play back any tapes recorded on this Camcorder.
Playing back a tape recorded in other equipment may produce mosaic shaped distortion.
- When you record a tape in SP and LP modes, or LP mode only, the playback picture may be distorted or the time code may not be written properly if there is a gap between scenes.
- Record using SP mode for best picture and sound quality.

[Caution]

- To edit audio on your camcorder, you must set 12Bit for the Audio Mode and SP for the Rec Mode.

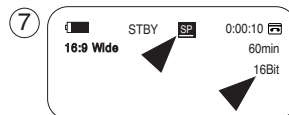
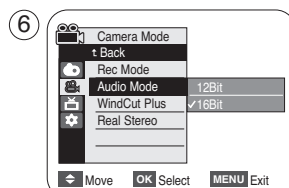
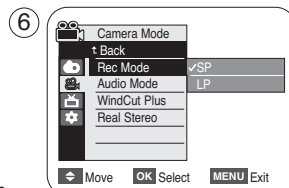
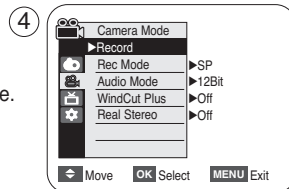

Advanced Recording

Cutting Off Wind Noise (WindCut Plus)

- ❖ The WindCut Plus function works in both <Camera> and <Player> (Audio dubbing) modes. ➡page 19
- ❖ Use the WindCut Plus when recording in windy places such as the beach or near buildings.
- ❖ The WindCut Plus function minimizes wind or other noises while recording.
 - When the WindCut Plus is on, some low pitched tones are eliminated along with the sound of the wind.

1. Set the [Power] switch to [CAMERA] or [PLAYER].
2. Set the [Mode] switch to [TAPE]. (VP-D375W(i)/D975W(i) only)
3. Press the [MENU] button.
4. Press the [▲ / ▼] button to select <Record>, then press the [OK] button.
5. Press the [▲ / ▼] button to select <WindCut Plus>, then press the [OK] button.
6. To activate the WindCut Plus function, press the [▲ / ▼] button to select <On> or <Auto> then press the [OK] button.
 - <On>: Removes the low pitched wind noise.
 - <Auto>: Minimizes the wind noise while preserving voices.
7. To exit, press the [MENU] button.
 - WindCut Plus (<On> [F7] or <Auto> [F8]) icon is displayed.

[Notes]

- Make sure WindCut Plus is set to off when you want the microphone to be as sensitive as possible.
- WindCut Plus function is not available in USB Streaming mode. (VP-D375W(i)/D975W(i) only)

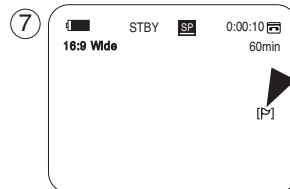
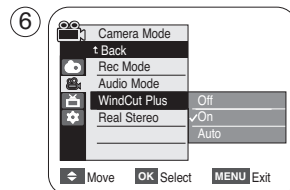
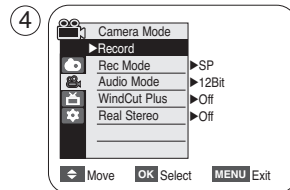

Advanced Recording

Selecting the Real Stereo Function

- ❖ The Real Stereo function works only in <Camera> mode. →page 19
- ❖ Real Stereo enhances the left and right input signals when using the internal microphone.

1. Set the [Power] switch to [CAMERA].
2. Set the [Mode] switch to [TAPE]. (VP-D375W(i)/D975W(i) only)
3. Press the [MENU] button.
4. Press the [▲ / ▼] button to select <Record>, then press the [OK] button.
5. Press the [▲ / ▼] button to select <Real Stereo>, then press the [OK] button.
6. To activate the Real Stereo function, press the [▲ / ▼] button to select <On>, then press the [OK] button.
7. To exit, press the [MENU] button.
 - Real Stereo (🔊) icon is displayed.

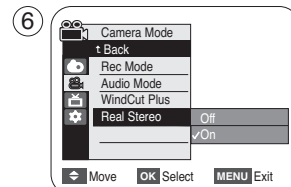
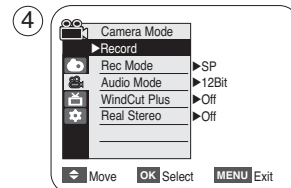
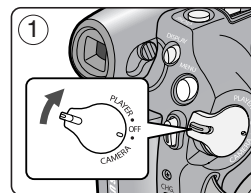

Advanced Recording

Setting the Shutter Speed & Exposure

- ❖ The Shutter Speed function works only in <Camera> mode. ➡page 19
- ❖ The Exposure function works in both <Camera> and <M.Cam> modes. ➡page 19
- ❖ The Shutter Speed and Exposure functions can be set in the QUICK MENU.

1. Set the [Power] switch to [CAMERA].
2. Set the [Mode] switch to [TAPE]. (VP-D375W(i)/D975W(i) only)
3. Press the [Q.MENU] button.
 - Quick menu list will appear.
4. Press the [▲ / ▼] button to select <Shutter> or <Exposure>, then press the [OK] button.
5. Press the [▲ / ▼] button to select <Manual>, then press the [OK] button.
6. Press the [▲ / ▼] button to select the desired shutter speed or exposure value, then press the [OK] button.
 - Shutter speed can be set to <1/50>, <1/120>, <1/250>, <1/500>, <1/1000>, <1/2000>, <1/4000> or <1/10000>.
 - Exposure value can be set between <00> and <29>.
7. To exit, press the [Q.MENU] button.
 - Selected settings are displayed.

Recommended Shutter Speeds when Recording

- ❖ Outdoor sports such as golf or tennis: <1/2000> or <1/4000>
- ❖ Moving cars or trains or other rapidly moving vehicles such as roller coasters: <1/1000>, <1/500> or <1/250>
- ❖ Indoor sports such as basketball: <1/120>

Adjusting the Exposure When Recording

- ❖ If you set Exposure to Manual, the higher the exposure, the brighter the recorded picture will be.

[Notes]

- If you manually change the Shutter Speed and the Exposure value when Program AE option is selected, manual changes are applied first.
- The image may not seem as smooth when a high Shutter Speed is set.
- The Camcorder returns to the auto shutter and auto exposure settings when you change to the EASY.Q mode.
- When recording with a Shutter Speed of 1/1000 or higher, make sure the sun is not shining into the lens.
- The Program AE cannot be set when the Shutter Speed or the Exposure is set to manual.

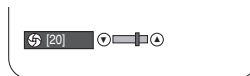
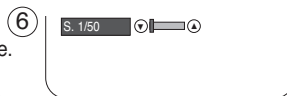
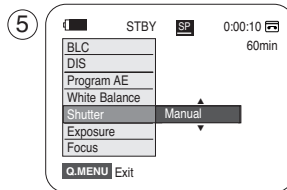
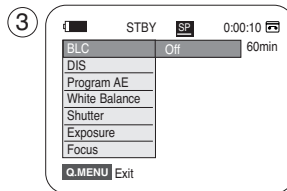

Advanced Recording

Auto Focus / Manual Focus

- ❖ The Auto Focus/Manual Focus function works in both <Camera> and <M.Cam> modes. ➔page 19
- ❖ In most situations, it is better to use the automatic focus feature, as it enables you to concentrate on the creative side of your recording.
- ❖ Manual focusing may be necessary under certain conditions that make automatic focusing difficult or unreliable.
- ❖ The Auto Focus/Manual Focus function can be set in the QUICK MENU.

Auto Focus

- ❖ If you are inexperienced in the use of Camcorders, we recommend that you make use of Auto Focus.

Manual Focus

- ❖ In the following situations, you may obtain better results by adjusting the focus manually.
 - A picture containing several objects, some close to the Camcorder, others further away.
 - A person enveloped in fog or surrounded by snow.
 - Very shiny or glossy surfaces like a car.
 - People or objects moving constantly or quickly like an athlete or a crowd.
- Set the [Power] switch to [CAMERA].
 - Set the [Mode] switch to [TAPE] or [CARD]. (VP-D375W(i)/D975W(i) only)
 - Press the [Q.MENU] button.
 - Quick menu list will appear.
 - Press the [▲ / ▼] button to select <Focus>, then press the [OK] button.
 - Press the [▲ / ▼] button to select <Manual>, then press the [OK] button.
 - To exit, press the [Q.MENU] button.
 - The [MF] icon and the [MF/AF] status bar will be displayed on the LCD screen.
 - Press the [▲ / ▼] button to adjust the focus.

[Note]

Manual Focus is not available in the EASY.Q mode.

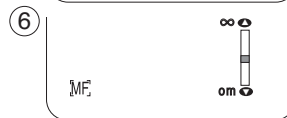
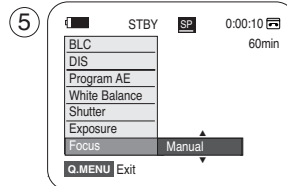
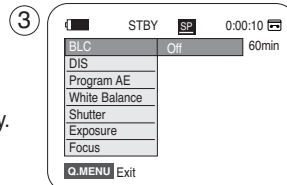
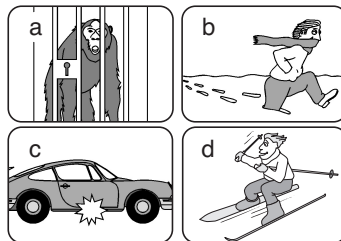

Advanced Recording

Programmed Automatic Exposure Modes (Program AE)

- ❖ The Program AE function works only in <Camera> mode. ➡ page 19
- ❖ The Program AE mode allows you to adjust shutter speeds and apertures to suit different recording conditions.
- ❖ They give you creative control over the depth of field.

■ <Auto (A)> mode

- Auto balance between the subject and the background.
- To be used in normal conditions.

■ <Sports (S)> mode

For recording people or objects moving quickly.

■ <Portrait (P)> mode

- For focusing on the background of the subject, when the background is out of focus.
- The Portrait mode is most effective when used outdoors.

■ <Spotlight (S)> mode

For recording correctly when there is only light on the subject and not the rest of the picture.

■ <Sand/Snow (S)> mode

For recording when people or objects are darker than the background because of reflected light from sand or snow.

■ <High Speed (S)> (High Shutter Speed) mode

For recording fast-moving subjects such as players in golf or tennis games.

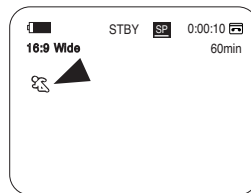

Advanced Recording

Setting the Program AE

1. Set the **[Power]** switch to **[CAMERA]**.
2. Set the **[Mode]** switch to **[TAPE]**. (VP-D375W(i)/D975W(i) only)
3. Press the **[MENU]** button.
 - The menu list will appear.
4. Press the **[▲ / ▼]** button to select **<Camera>**, then press the **[OK]** button.
5. Press the **[▲ / ▼]** button to select **<Program AE>**, then press the **[OK]** button.
 - The available options are listed.
6. Press the **[▲ / ▼]** button to select the desired program AE option, then press the **[OK]** button.
7. To exit, press the **[MENU]** button.
 - The icon of the selected mode is displayed.
 - When the **<Auto>** mode is selected, no icon is displayed.

[Notes]

- You can directly access the Program AE function using the **[Q.MENU]** button.
→page 20
- The Program AE function will not operate in EASY.Q mode.
- The Program AE cannot be set when the Shutter Speed or the Exposure is set to manual.

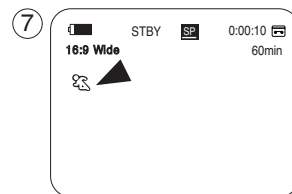
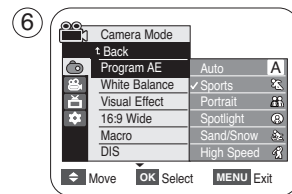
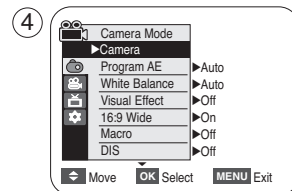

Advanced Recording

Setting the White Balance

- ❖ The White Balance function works in both <Camera> and <M.Cam> modes. ➔ page 19
- ❖ The White Balance is a recording function that preserves the unique image colour of the object in any recording condition.
- ❖ You may select the appropriate White Balance mode to obtain good quality image colour.
 - <Auto (A)> : This mode is generally used to control the White Balance automatically.
 - <Indoor (i)> : This controls the White Balance according to the indoor ambience.
 - Under halogen or studio/video lighting
 - Subject is of one dominant colour
 - Close up
 - <Outdoor (o)> : This controls the White Balance according to the outdoor ambience.
 - In daylight, especially for close up and where the subject is of one dominant colour.
 - <Custom WB (C)> : You can adjust the white balance as you wish based on the shooting environment.

1. Set the [Power] switch to [CAMERA].
2. Set the [Mode] switch to [TAPE] or [CARD]. (VP-D375W(i)/D975W(i) only)
3. Press the [MENU] button.
 - The menu list will appear.
4. Press the [▲ / ▼] button to select <Camera>, then press the [OK] button.
5. Press the [▲ / ▼] button to select <White Balance>, then press the [OK] button.

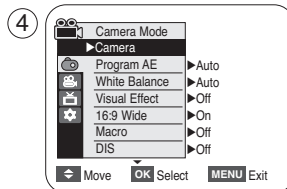

Advanced Recording

6. Press the **[▲ / ▼]** button to select the desired mode **<Auto>**, **<Indoor>**, **<Outdoor>** or **<Custom WB>**, then press the **[OK]** button.
- To explain about the Custom WB:
 - (1) Select Custom WB and press the **[OK]** button. (“Set white balance” will appear and blinks on the screen.)
 - (2) Place the white object under the desired lighting then press the **[OK]** button. (The OSD will disappear and the Custom WB icon () will be displayed.)
7. To exit, press the **[MENU]** button.
- When the **<Auto>** mode is selected, no icon is displayed.

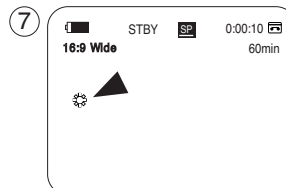
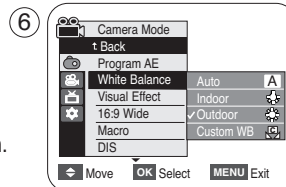

<When the Outdoor option was selected>

[Notes]

- You can directly access the White Balance function using the **[Q.MENU]** button.
 - ↳ page 20
- The White Balance function will not operate in EASY.Q mode.
- Turn the Digital Zoom off (if necessary) to set a more accurate white balance.
- Reset the white balance if lighting conditions change.
- During normal outdoor recording, setting to Auto may provide better results.
- Buttons other than EASY.Q button, **[MENU]** button, **[▲ / ▼]** button, **[Zoom]** lever and **[OK]** button will not work during setting the Custom WB.
- Pressing the **[MENU]** button while setting the Custom WB will cancel the Custom WB setting and sets the White Balance to Auto.

Advanced Recording

Applying Visual Effects

- ❖ The Visual Effect function works only in <Camera> mode. →page 19
- ❖ The Visual Effects enable you to give a creative look to your recording.
- ❖ Select the appropriate Visual Effect for the type of picture that you wish to record and the effect you wish to create. There are 10 Visual Effect modes.

1. <Art> mode

This mode gives the images a coarse effect.

2. <Mosaic> mode

This mode gives the images a mosaic effect.

3. <Sepia> mode

This mode gives the images a reddish-brown pigment.

4. <Negative> mode

This mode reverses the colours, creating a negative image.

5. <Mirror> mode

This mode cuts the picture in half, using a mirror effect.

6. <BLK&WHT> mode

This mode changes the images to black and white.

7. <Emboss1> mode

This mode creates a 3D effect (embossing).

8. <Emboss2> mode

This mode creates a 3D effect (embossing) on surrounding area of an image.

9. <Pastel1> mode

This mode applies a pale pastel drawing effect to an image.

10.<Pastel2> mode

This mode applies a pale pastel drawing effect to surrounding area of an image.

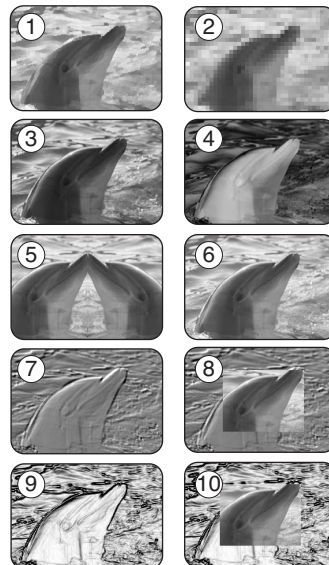

Advanced Recording

Selecting the Visual Effects

1. Set the **[Power]** switch to **[CAMERA]**.
2. Set the **[Mode]** switch to **[TAPE]**. (VP-D375W(i)/D975W(i) only)
3. Press the **[MENU]** button.
 - The menu list will appear.
4. Press the **[▲ / ▼]** button to select **<Camera>**, then press the **[OK]** button.
5. Press the **[▲ / ▼]** button to select **<Visual Effect>**, then press the **[OK]** button.
6. Press the **[▲ / ▼]** button to select the desired Visual Effect option, then press the **[OK]** button.
 - The display mode is set to the selected mode.
7. To exit, press the **[MENU]** button.

[Notes]

- The Mosaic, Mirror, Emboss2 or Pastel2 mode is not available while DIS or COLOUR NITE is in use.
- Visual Effect modes are not available while EASY.Q is in use.
- Once DIS or COLOUR NITE is set, Mosaic, Mirror, Emboss2 or Pastel2 mode will be released.
- Mirror mode is not available in the 16:9 Wide mode.
(VP-D371W(i)/D372WH(i)/D375W(i)/D975W(i) only)
- Digital Zoom is not available in the Mosaic, Mirror, Emboss2 or Pastel2 mode.
- Once Visual Effect is set, 16:9 Wide mode will be released. (VP-D371(i) only)

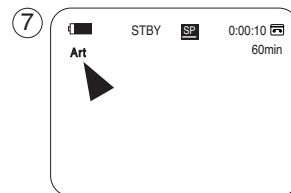
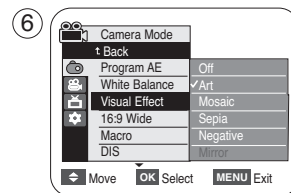
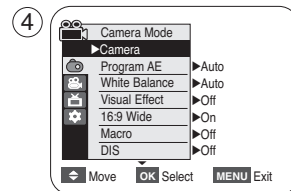

Advanced Recording

Setting the 16:9 Wide mode

- ❖ The 16:9 Wide function works only in <Camera> mode. ➡page 19
- ❖ Recordings in 16:9 Wide will play back naturally only when the TV supports 16:9 aspect ratio.
- ❖ 16:9 Wide is the default setting for models VP-D371W(i)/D372WH(i)/D375W(i)/D975W(i).

1. Set the **[Power]** switch to **[CAMERA]**.
2. Set the **[Mode]** switch to **[TAPE]**. (VP-D375W(i)/D975W(i) only)
3. Press the **[MENU]** button.
 - The menu list will appear.
4. Press the **[▲ / ▼]** button to select <Camera>, then press the **[OK]** button.
5. Press the **[▲ / ▼]** button to select <16:9 Wide>, then press the **[OK]** button.
6. To activate the 16:9 Wide function, press the **[▲ / ▼]** button to select <On>, then press the **[OK]** button.
 - If you do not want to use the 16:9 Wide function, set the <16:9 Wide> menu to <Off>.
7. To exit, press the **[MENU]** button.
 - The selected icon is displayed.

[Notes]

- Digital Zoom and COLOUR NITE is not available in the 16:9 Wide mode.
- Still image recording is not available in the 16:9 Wide mode. ➡page 59
- Once Visual Effect or DIS is set, 16:9 Wide mode will be released. (VP-D371(i) only)

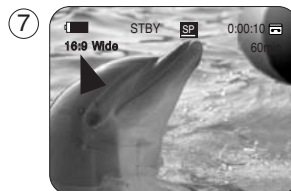
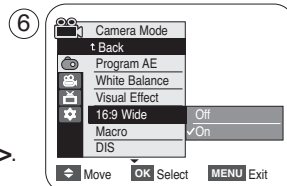
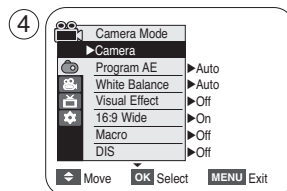

Advanced Recording

Using the Tele Macro (Macro)

- ❖ Tele Macro function works in both <Camera> and <M.Cam> mode. ➡page 19
- ❖ Effective focal distance in Tele Macro mode is 50 Cm (19.7 inches) ~ 100 Cm (39.4 inches).

1. Set the [Power] switch to [CAMERA].
2. Set the [Mode] switch to [TAPE] or [CARD]. (VP-D375W(i)/D975W(i) only)
3. Press the [MENU] button.
 - The menu list will appear.
4. Press the [▲ / ▼] button to select <Camera>, then press the [OK] button.
5. Press the [▲ / ▼] button to select <Macro>, then press the [OK] button.
6. To activate the Macro function, press the [▲ / ▼] button to select <On>, then press the [OK] button.
 - If you do not want to use the Macro function, set the <Macro> menu to <Off>.
7. To exit, press the [MENU] button.
 - Tele Macro (📷) icon is displayed.

[Notes]

- When recording in Tele Macro mode, the focus speed may be slow.
- When you operate the Zoom function in the Tele Macro mode, the recording subject may be out of focus.
- Use a tripod (not supplied) to prevent hand shake in the Tele Macro mode.
- Avoid shadows when recording in the Tele Macro mode.
- As the distance to the subject decreases, focusing area narrows.
- When you can not get proper focus, use the [▲ / ▼] button or [Zoom] lever.

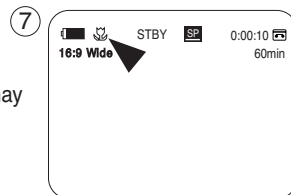
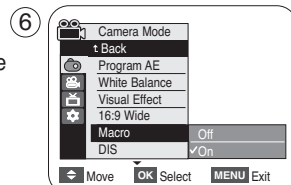
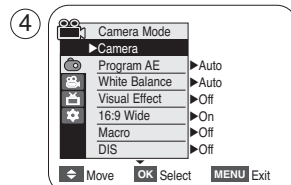

Advanced Recording

Setting the Digital Image Stabilizer (DIS)

- ❖ The DIS function works only in <Camera> mode. ➡page 19
 - ❖ DIS (Digital Image Stabilizer) is a function that compensates for any shaking or hand movement while holding the Camcorder (within reasonable limits).
 - ❖ It provides more stable pictures when:
 - Recording with the zoom (Digital Zoom is not available in the DIS mode.)
 - Recording a small object close-up
 - Recording and walking at the same time
 - Recording through the window of a vehicle
1. Set the [Power] switch to [CAMERA].
 2. Set the [Mode] switch to [TAPE]. (VP-D375W(i)/D975W(i) only)
 3. Press the [MENU] button.
 - The menu list will appear.
 4. Press the [▲ / ▼] button to select <Camera>, then press the [OK] button.
 5. Press the [▲ / ▼] button to select <DIS>, then press the [OK] button.
 6. To activate the DIS function, press the [▲ / ▼] button to select <On>, then press the [OK] button.
 - If you do not want to use the DIS function, set the <DIS> menu to <Off>.
 7. To exit, press the [MENU] button.
 - DIS (📷) icon is displayed.

[Notes]

- You can directly access the DIS function using the [Q.MENU] button. ➡page 20
- Digital Zoom, COLOUR NITE, Mosaic, Mirror, Emboss2 or Pastel2 is not available in the DIS mode.
- DIS function in 16:9 Wide mode may produce lower quality than in normal mode. (VP-D371W(i)/D372WH(i)/D375W(i)/D975W(i) only)
- When you press the [PHOTO] button while the DIS function is enabled, the DIS will be released shortly and resume automatically after the still image recording.
- It is recommended that you deactivate the DIS function when using a tripod.
- If you use the DIS function, the picture quality may deteriorate.
- EASY.Q mode automatically sets the <DIS> to <On>.
- 16:9 Wide mode is not available in DIS mode. (VP-D371(i) only)
- Once DIS is set, 16:9 Wide mode will be released. (VP-D371(i) only)

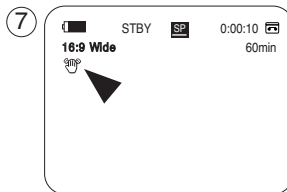
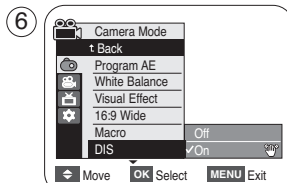
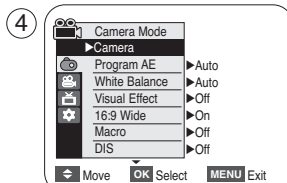

Advanced Recording

Using Back Light Compensation Mode (BLC)

- ❖ BLC works in both <Camera> and <M.Cam> modes. ➡page 19
- ❖ Back lighting exists when the subject is darker than the background:
 - The subject is in front of a window.
 - The person to be recorded is wearing white or shiny clothes and is placed against a bright background; the person's face is too dark to distinguish his/her features.
 - The subject is outdoors and the background is overcast.
 - The light sources are too bright.
 - The subject is against a snowy background.

1. Set the [Power] switch to [CAMERA].
2. Set the [Mode] switch to [TAPE] or [CARD]. (VP-D375W(i)/D975W(i) only)
3. Press the [MENU] button.
 - The menu list will appear.
4. Press the [▲ / ▼] button to select <Camera>, then press the [OK] button.
5. Press the [▲ / ▼] button to select <BLC>, then press the [OK] button.
6. Press the [▲ / ▼] button to select <On>, then press the [OK] button.
7. To exit, press the [MENU] button.
 - BLC icon (🌞) will be displayed.

[Notes]

- You can directly access the BLC function using the [Q.MENU] button. ➡page 20
- The BLC function will not operate in EASY.Q mode.



<BLC Off>

<BLC On>

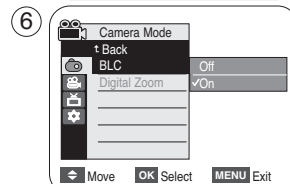
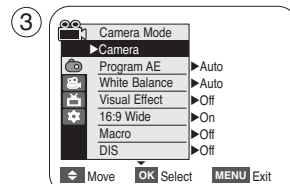

Advanced Recording

Zooming In and Out with Digital Zoom (Digital Zoom)

- ❖ Maximum Digital Zoom works only in <Camera> mode. ➔page 19
- ❖ Zooming more than 34x(VP-D371(i)/D371W(i)/D372WH(i)/D375W(i) only), 26x(VP-D975W(i) only) is achieved digitally, up to 1200x when combined with optical zoom.
- ❖ The picture quality may deteriorate depending on how much you digitally zoom in on the subject.
- ❖ **Please disable 16:9 Wide mode to use this function.** ➔page 54

Selecting the Digital Zoom

1. Set the [Power] switch to [CAMERA].
2. Set the [Mode] switch to [TAPE]. (VP-D375W(i)/D975W(i) only)
3. Press the [MENU] button.
 - The menu list will appear.
4. Press the [▲ / ▼] button to select <Camera>, then press the [OK] button.
5. Press the [▲ / ▼] button to select <Digital Zoom>, then press the [OK] button.
6. Press the [▲ / ▼] button to select the desired zoom value <Off>, <100x>, <200x>, <400x> or <1200x>, then press the [OK] button.
7. To exit, press the [MENU] button.
 - Press the [▲ / ▼] button or move the [Zoom] lever to use the Digital Zoom.
 - The Digital Zoom indicator appears.

[Notes]

- Maximum Digital zooming may result in lower picture quality.
- Digital Zoom is not available while DIS, EASY.Q, still image recording, COLOUR NITE, 16:9 Wide, Mosaic, Mirror, Emboss2 and Pastel2 is in use.
- Once still image recording, COLOUR NITE, 16:9 Wide, EASY.Q, Mosaic, Mirror, Emboss2 or Pastel2 is set, Digital Zoom mode will be released. (The Digital Zoom mode will be backed up.)
- Once DIS is set, Digital Zoom mode will be released.

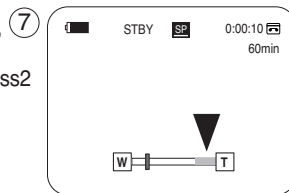
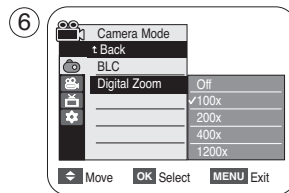
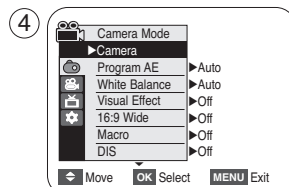

Advanced Recording

Still Image Recording

- ❖ Still image recording works only in <Camera> mode. ➔page 19
 - ❖ A tape must be inserted as still images are recorded on a tape.
 - ❖ **Please disable 16:9 Wide mode to use this function.** ➔page 54
1. Set the **[Power]** switch to **[CAMERA]**.
 2. Set the **[Mode]** switch to **[TAPE]**. (VP-D375W(i)/D975W(i) only)
 3. Press the **[PHOTO]** button.
 - The still image is recorded for about 6~7 seconds.
 4. After the still image has been recorded, the Camcorder returns to its previous mode.

Searching for a still image

- ❖ The Photo Search works only in <Player> mode. ➔page 19
1. Set the **[Power]** switch to **[PLAYER]**.
 2. Set the **[Mode]** switch to **[TAPE]**. (VP-D375W(i)/D975W(i) only)
 3. Press the **[MENU]** button.
 - The menu list will appear.
 4. Press the **[▲/▼]** button to select <Tape>, then press the **[OK]** button.
 5. Press the **[▲/▼]** button to select <Photo Search>, then press the **[OK]** button.
 - ◀▶ will flicker on the LCD screen.
 6. Press the **[◀▶]** (**REW/FF**) buttons to search the still image.
 - The photo search process appears while you are searching.
 - After completing the search, the Camcorder displays the still image.
 - When there are no still images recorded on the tape, it will be fully rewound or forwarded.
 7. To exit, press the **[■ (STOP)]** or **[MENU]** button.

[Notes]

- Still image recording is not available while recording.
- You can use still image recording by using the **[PHOTO]** button on the remote control. Pressing the **[PHOTO]** button on the remote control records the still image with automatic focusing. (VP-D375W(i)/D975W(i) only)
- Still image recording is not available while COLOUR NITE or 16:9 Wide is in use.
- DIS, Digital Zoom and COLOUR NITE are not available when still image recording.
- Still image recording while EASY.Q, DIS or Digital Zoom mode is in use will release the current mode. (After a still image is taken, the mode will return automatically.)

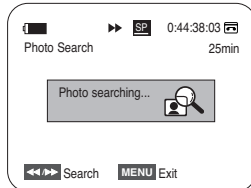
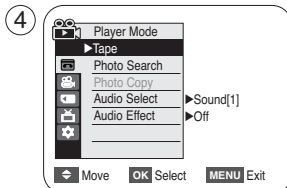
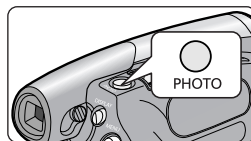

Playback

Playing Back a Tape on the LCD Screen

- ❖ The Playback function and speaker works only in <Player> mode. ➔page 19
- ❖ You can monitor the playback picture on the LCD Screen.

1. Set the **[Power]** switch to **[PLAYER]**.
2. Set the **[Mode]** switch to **[TAPE]**. (VP-D375W(i)/D975W(i) only)
3. Insert the tape you wish to view. ➔page 32
4. Open the LCD Screen.
 - Adjust the angle of the LCD Screen and set the brightness or colour if necessary.
5. Press the **[◀◀ (REW)]** button to rewind the tape to the starting point.
 - To stop rewinding, press the **[■ (STOP)]** button.
 - The Camcorder stops automatically after rewinding is completed.
6. Press the **[▶▶ (PLAY/STILL)]** button to start playback.
 - You can view the picture you recorded on the LCD Screen.
 - To stop the play operation, press the **[■ (STOP)]** button.

Adjusting the LCD Bright/LCD Colour during Playback

- ❖ You can adjust the LCD Bright/LCD Colour during playback.
- ❖ The adjustment method is the same procedure as used in <Camera> mode. ➔page 29

Adjusting the Volume

- ❖ When you use the LCD Screen for playback, you can hear recorded sound from the built-in Speaker.
 - Take the following steps to lower the volume or mute the sound while playing a tape on the Camcorder.
- ❖ When sound is heard once the tape is in play, use the **[▲ / ▼]** button to adjust the volume.
 - A volume level display will appear on the LCD Screen.
 - Levels may be adjusted from anywhere between <00> to <19>.
 - If you close the LCD Screen while playing, you will not hear sound from the speaker.
- ❖ When the Audio/Video cable is connected to the Camcorder, you cannot hear sound from the Built-In Speaker and cannot adjust the volume.

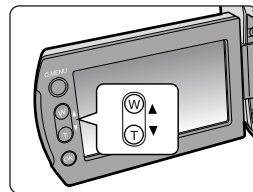
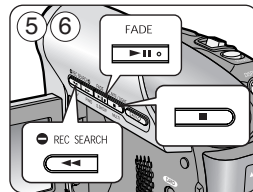

Playback

Various Functions while in Player Mode

- ❖ This function works only in <Player> mode. ➔page 19
- ❖ The [PLAY], [STILL], [STOP], [FF] and [REW] buttons are located on the Camcorder and the remote control.
(VP-D375W(i)/D975W(i) only)
- ❖ The [F.ADV] (Frame advance), [X2] and [SLOW] buttons are located on the remote control only.
(VP-D375W(i)/D975W(i) only)
- ❖ To prevent tape and head-drum wear, your Camcorder will automatically stop if it is left in still or slow modes for more than 3 minutes.

Playback Pause

- Press the [▶II (PLAY/STILL)] button during playback.
- To resume playback, press the [▶II (PLAY/STILL)] button.

Picture Search (Forward/Reverse)

- Press the [◀◀ (REW)] / [▶▶ (FF)] buttons during playback or still mode.
To resume normal playback, press the [▶II (PLAY/STILL)] button.
- Keep pressing [◀◀ (REW)] / [▶▶ (FF)] buttons during playback or still mode.
To resume normal playback, release the button.

Slow Playback (Forward/Reverse) (VP-D375W(i)/D975W(i) only)

- Forward Slow Playback
 - Press the [SLOW] button on the remote control during playback.
 - To resume normal playback, press the [▶II (PLAY/STILL)] button.
- Reverse Slow Playback
 - Press the [◀II (-)] button during forward slow play back.
 - To resume forward slow playback, press the [II▶ (+)] button.
 - To resume normal playback, press the [▶II (PLAY/STILL)] button.

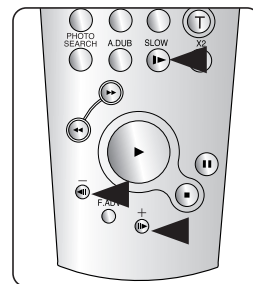
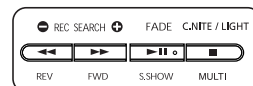

<VP-D375W(i)/D975W(i) only>

Playback

Frame Advance (To play back frame by frame) (VP-D375W(i)/D975W(i) only)

- Press the **[F.ADV]** button on the remote control while in still mode.
 - Video sequence advances frame by frame each time you press the **[F.ADV]** button.
 - The F.ADV function works in still mode only.
- To resume normal playback, press the **[▶ (PLAY)]** button.
 - **Forward frame advance.**
Press the **[F.ADV]** button on the remote control in still mode.
 - **Reverse frame advance**
Press the **[◀|| (-)]** button on the remote control to change the direction in F.ADV mode.
Press the **[F.ADV]** button on the remote control.

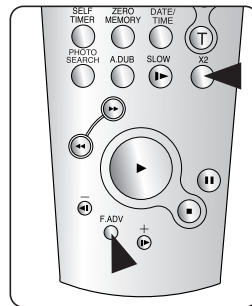

<VP-D375W(i)/D975W(i) only>

X2 Playback (Forward/Reverse) (VP-D375W(i)/D975W(i) only)

- Forward X2 Playback
 - Press the **[X2]** button on the remote control during playback.
 - To resume normal playback, press the **[▶ (PLAY)]** button.
- Reverse X2 Playback
 - Press the **[◀|| (-)]** button during forward X2 playback.
 - To resume normal playback, press the **[▶ (PLAY)]** button.

Reverse Playback (VP-D375W(i)/D975W(i) only)

- To playback in reverse at normal speed, press the **[◀|| (-)]** button on the remote control during normal forward playback.
- Press the **[▶ (PLAY)]** or **[||▶ (+)]** button to return to normal forward playback.

[Notes]

- Mosaic shaped distortion may appear on the screen while in some of the various playback modes. Mosaic shaped distortion or noise may be experienced when you play back tapes recorded in LP which contain various playback functions.
- Sound will only be heard during normal SP or LP playback.

Playback

Audio Dubbing (VP-D375W(i)/D975W(i) only)

- ❖ The Audio Dubbing function works only in <Player> mode. ↪ page 19
- ❖ You can not dub sound on a pre-recorded tape in LP or 16 bit mode.
- ❖ You can add sound to the original sound on a pre-recorded tape recorded in SP mode with 12bit sound.
- ❖ Use the internal microphone or other audio equipment. (VP-D371i/D371Wi/D372WHi/D375Wi/D975Wi only)
- ❖ The original sound will not be erased.

1. Set the **[Power]** switch to **[PLAYER]**.
2. Set the **[Mode]** switch to **[TAPE]**.
3. Press the **[▶II (PLAY/STILL)]** button and find the time frame of the scene to be dubbed.
4. Press the **[▶II (PLAY/STILL)]** button to pause the scene.
5. Press the **[A.DUB]** button on the remote control.
 - Audio Dubbing icon () is displayed.
 - The Camcorder is ready for dubbing.
6. Press the **[▶II (PLAY/STILL)]** button to start dubbing.
 - Press the **[■ (STOP)]** button to stop the dubbing.

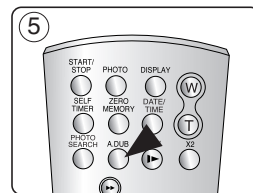
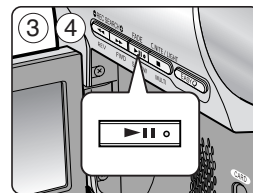

[Notes]

- You can not use the Audio Dubbing function while playing a write protected video tape.
- To utilize an external sound source, use the Audio/Video cable to connect external sound source input.
To dub an external sound source, set <AV In/Out> function to <In>. (VP-D371i/D371Wi/D372WHi/D375Wi/D975Wi only)
↪ page 69

Playback

Dubbed Audio Playback

❖ The dubbed Audio Playback function works only in <Player> mode. ➤page 19

1. Set the [Power] switch to [PLAYER].
2. Set the [Mode] switch to [TAPE]. (VP-D375W(i)/D975W(i) only)
3. Insert the dubbed tape and press the [MENU] button.
4. Press the [▲ / ▼] button to select <Tape>, then press the [OK] button.
5. Press the [▲ / ▼] button to select <Audio Select>, then press the [OK] button.
6. Press the [▲ / ▼] button to select the audio playback channel, then press the [OK] button.
 - <Sound[1]>: Plays the original sound.
 - <Sound[2]>: Plays the dubbed sound.
 - <MIX[1+2]>: Plays back Sound 1 and 2 equally mixed.
7. To exit, press the [MENU] button.
8. Press the [▶II (PLAY/STILL)] button to playback the dubbed tape.

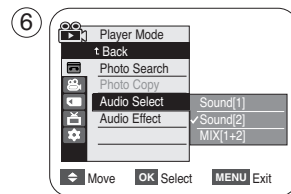
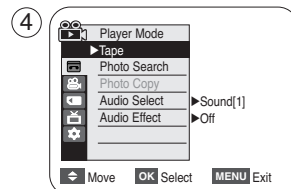

[Note]

When you play back added sound (Sound[2] or MIX[1+2]), you may experience a loss of sound quality.

Playback

Tape Playback on TV Screen

❖ The Playback function works only in <Player> mode. ➡page 19

Playing back on a TV Monitor

- ❖ To play back a tape, the television must be PAL compatible. ➡page 101
- ❖ We recommend that you use the AC Power adapter as the power source for the Camcorder.

Connecting to a TV which has Audio/Video Input Jacks

1. Connect the Camcorder to your TV with the Audio/Video Cable.
 - The yellow jack: Video
 - The white jack: Audio(L)-mono, The red jack: Audio(R)
 - If you connect to a monaural TV, connect the yellow jack (Video) to the video input of the TV and the white jack (Audio L) to the audio input of the TV.
2. Set the **[Power]** switch to **[PLAYER]**.
3. Set the **[Mode]** switch to **[TAPE]**. (VP-D375W(i)/D975W(i) only)
4. Turn on the TV and set the TV/VIDEO selector on the TV to Video.
 - Refer to the TV user's manual.
5. Play the tape. ➡page 60

[Notes]

- If you connect the cable to the AV jack, you will not hear sound from the Camcorder's speaker.
- If only a mono audio input is available on the TV set, use the audio cable with the white jack (Audio L).

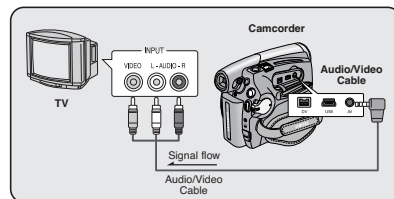

VP-D371(i)/D371W(i)/
D372WH(i)



VP-D375W(i)/D975W(i)

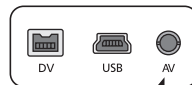

Playback

Connecting to a TV which has no Audio/Video Input Jacks

- ❖ You can connect your Camcorder to a TV through a VCR.
1. Connect the Camcorder to your VCR with the Audio/Video Cable.
 - The yellow jack: Video
 - The white jack: Audio(L) - Mono
 - The red jack: Audio(R)
 2. Connect a TV to the VCR.
 3. Set the **[Power]** switch to **[PLAYER]**.
 4. Set the **[Mode]** switch to **[TAPE]**. (VP-D375W(i)/D975W(i) only)
 5. Turn on both the TV and VCR.
 - Set the input selector on the VCR to Line.
 - Select the channel reserved for your VCR on the TV set.
 6. Play the tape.

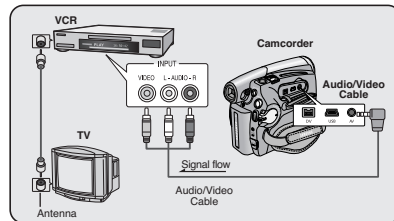

VP-D371(i)/D371W(i)/
D372WH(i)



VP-D375W(i)/D975W(i)

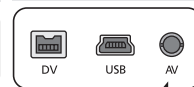

Playback

1. Connect a power source and set the **[Power]** switch to **[PLAYER]**.
2. Set the **[Mode]** switch to **[TAPE]**. (VP-D375W(i)/D975W(i) only)
3. Insert the tape you wish to play back.
4. Using the **[◀◀ (REW)]/[▶▶ (FF)]** buttons, find the first position you wish to play back.
5. Press the **[▶II (PLAY/STILL)]** button.
 - The images you recorded will appear on the TV after a few seconds.
 - If a tape reaches its end while being played back, the tape will rewind automatically.

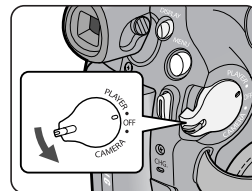

[Notes]

- The playback mode (SP/LP) is selected automatically.
- If only a mono audio input is available on the TV set, use the audio cable with the white jack (Audio L).

Playback

VOICE + Function

- ❖ The Voice+ function works only in <Player> mode. ➡ page 19
- ❖ When you want to play back or record a tape-recorded movie on other AV device, you can transfer the voice sound incoming from the internal microphone of your camcorder, instead of the audio signals on a pre-recorded tape.

1. Connect the provided Audio/Video Cable to the AV Jack of the Camcorder.
2. Connect the other end of the cable to the VCR/DVD Recorder/TV by matching the colours of the terminals.
3. Set the **[Power]** switch to **[PLAYER]**.
4. Set the **[Mode]** switch to **[TAPE]**. (VP-D375W(i)/D975W(i) only)
5. Insert the tape you wish to play back in this camcorder.
6. Press the **[Start/Stop]** button on a point where you want during the playback.
 - Voice+ icon () is displayed on the screen and <VOICE+> will flicker on the screen for a while.
 - Sound incoming from the internal microphone will be transferred to the connected AV device, instead of the pre-recorded sound on a tape.
7. To cancel the function, press the **[Start/Stop]** button again.

[Notes]

- VOICE+ is available only when the Audio/Video cable is connected. If other cable (DV cable or USB cable (VP-D375W(i)/D975W(i) only)) is connected, VOICE+ function may not operate properly.
- If you perform **[STOP]**, **[PLAY/STILL]**, **[REW]** or **[FF]** button when you operate Voice+ function, Voice+ function will be deactivated.
- During the VOICE+ process, the functions of **[MENU]** button or **[PHOTO]** button do not work.
- The VOICE+ function does not affect the original sound on the recorded tape.
- Sound is transferred from the internal microphone on this camcorder to the connected AV device, when using the Voice+ function. So take care that this microphone is not blocked.
- Adjust the sound volume on the connected external device. (TV, etc.)
- Howling may occur near the speaker of an external device, please keep the camcorder at a distance from the external device.
- Before connecting, make sure that the volume on the external device is turned down: forgetting this may cause howling from the external device's speakers.

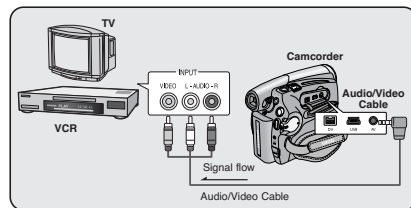

VP-D371(i)/D371W(i)/
D372WH(i)

VP-D375W(i)/D975W(i)

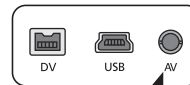

5



6



Playback

Audio Effect

- ❖ Audio Effect function works only in <Player> mode. ➔page 19
- ❖ Audio Effect provides various playback effects to audio signals stored on a tape.

1. Set the [Power] switch to [PLAYER].
2. Set the [Mode] switch to [TAPE]. (VP-D375W(i)/D975W(i) only)
3. Insert the recorded tape and press the [MENU] button.
4. Press the [▲/▼] button to select <Tape>, then press the [OK] button.
5. Press the [▲/▼] button to select <Audio Effect>, then press the [OK] button.
6. Press the [▲/▼] button to select the audio effect channel, then press the [OK] button.
 - <Voice>: Highlights the human voice.
 - <Music>: Highlights the sound by enhancing the bass and treble.
 - <Wide>: Magnifies the stereo effect by enhancing the left and right sounds.
 - <Echo>: Gives an echo effect.
7. To exit, press the [MENU] button.

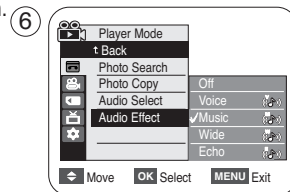
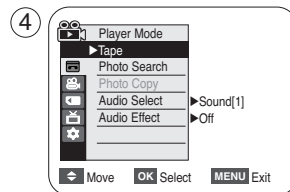

[Notes]

- It is recommended to use stereo type output devices (TV, speakers) for better audio effects.
- Audio Effect function is not available with USB (VP-D375W(i)/D975W(i) only) or DV connection.

Playback

Setting the AV In/Out (VP-D371i/D371Wi/D372WHi/D375Wi/D975Wi only)

- ❖ AV In/Out function works only in <Player> mode. ➔page 19
- ❖ AV In/Out setting enables you to record signals from external sources and display it on LCD Screen. Also, you can send your video or image to external devices to record or play back.

1. Set the [Power] switch to [PLAYER].
2. Set the [Mode] switch to [TAPE].
3. Press the [MENU] button.
 - The menu list will appear.
4. Press the [▲ / ▼] button to select <Record>, then press the [OK] button.
5. Press the [▲ / ▼] button to select <AV In/Out>, then press the [OK] button.
6. Press the [▲ / ▼] button to select <Out> or <In>, then press the [OK] button.
 - <Out>: Select this when copying or playing back the contents of this camcorder onto the external device.
 - <In>: Select this when recording the contents of an external device to the camcorder.
7. To exit, press the [MENU] button.

[Notes]

- When recording images from a VCR, playback must be at normal speed, or a gray image will appear on the Camcorder.
- If <AV In/Out> is set to <In>, the WindCut Plus function is not available.

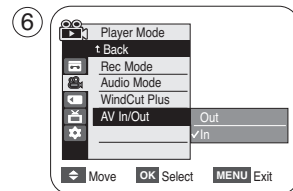
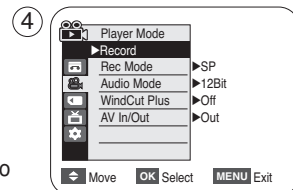
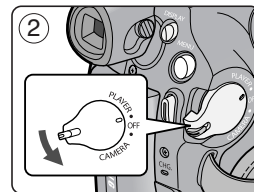

Connection

Copying a Camcorder Tape onto a Video Tape

- ❖ The copying function works only in <Player> Mode. ➡ page 19
- ❖ Connect your Camcorder to a VCR using the AV jack to copy the recording from a camcorder tape onto a VCR tape.
- ❖ Set the <AV In/Out> to <Out> before copying to an external device.
➡ page 69

1. Set the [Power] switch to [PLAYER].
2. Set the [Mode] switch to [TAPE]. (VP-D375W(i)/D975W(i) only)
3. Insert the tape you want to copy in your Camcorder.
4. Insert a new video tape in your VCR.
5. Connect the Camcorder to your VCR with the Audio/Video cable.
 - Connect the Audio/Video cable to the input jack on your VCR.
 - The yellow jack: Video
 - The white jack: Audio(L)-mono
 - The red jack: Audio(R)
6. Press the Record button on your VCR to start recording.
7. Play the tape on your Camcorder. Please refer to Page 60 for Playing.
 - Set the <TV Display> to <Off> in the MENU. ➡ page 31

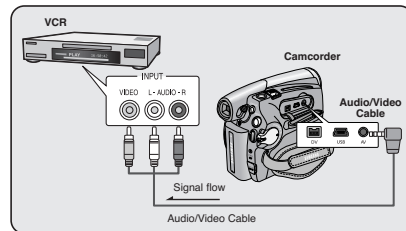

VP-D371(i)/D371W(i)/
D372WH(i)



VP-D375W(i)/D975W(i)

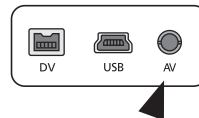

When Copying is Complete

Stop recording on your VCR, then press the [■ (STOP)] button on your Camcorder.

[Notes]

- If you operate the Camcorder connected to another device, always power the Camcorder from household AC outlet using the AC power adapter.
- You can also copy images to other external storage media using this camcorder.

Connection

Recording (Copying) a TV Programme or Video Tape onto a Camcorder Tape (VP-D371(i)/D371Wi/D372WH(i)/D375Wi/D975Wi only)

- ❖ The Recording (Copying) function works only in <Player> Mode.
➡ page 19
- ❖ Connect your Camcorder to a VCR or a TV using the AV jack to record a TV programme or copy a video tape onto a Camcorder tape.
- ❖ **Set the <AV In/Out> to <In> before Recording (Copying).** ➡ page 69

Recording (Copying) onto a Camcorder Tape

1. Get your TV or VCR ready.
2. Connect the Camcorder to your VCR or TV with the Audio/Video cable.
 - Connect the Audio/Video cable to the output jack on your VCR or TV
 - The yellow jack: Video
 - The white jack: Audio (L)- Mono
 - The red jack: Audio (R)
3. Insert an empty tape in your Camcorder.

To record from a VCR

4. Insert the video tape to be played in your VCR.
 - Pause at the starting point of playing.
5. Start copying by pressing the **[Start/Stop]** button on your Camcorder.
6. Press the **PLAY** button on your VCR to play the tape.

To record from a TV

4. Select a TV channel to be recorded.
5. Start recording by pressing the **[Start/Stop]** button on your Camcorder.

When Recording (Copying) is Complete:

Press the **[■ (Stop)]** button on your Camcorder to stop recording (copying).

[Notes]

- If you operate the Camcorder connected to another device, always power the Camcorder from household AC outlet using the AC power adapter.
- The recorded contents can be played back in the same manner as when playing back images recorded on this camcorder.
- Copy-protected video tapes such as Macrovision or unstable TV signals cannot be recorded on this camcorder.

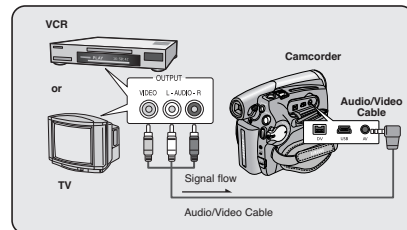

VP-D371 (i)/D371W(i)/
D372WH(i)



VP-D375W(i)/D975W(i)

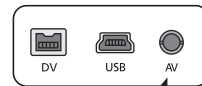

Digital Still Camera Mode (VP-D375W(i)/D975W(i) only)

Using a Memory Card (Usable Memory Card) (not supplied)

- ❖ This camcorder can use SD memory cards and MMC (Multi Media Cards).
Some cards are not compatible according to the memory card manufacturer and memory card type.
- ❖ The Memory Card stores and manages images recorded by the Camcorder.
- ❖ Before inserting or ejecting the Memory Card, set the **[Power]** switch to **[OFF]**.

Memory Card Functions

- ❖ Recording/Viewing Images.
- ❖ Protecting Images from accidental erasure. (except MMC)
- ❖ The MMC does not have a Protection Tab.
When using the MMC, be careful not to edit or delete data by mistake.
- ❖ Deleting Images stored in Memory Card
- ❖ Marking Photo Images with Print Information
- ❖ Formatting Memory Cards

Inserting a Memory Card

1. Open the Memory Card Cover.
2. Insert the Memory Card into the Slot until it softly clicks.
3. Insert the Memory Card into the Slot until it softly clicks.
4. Close the Memory Card Cover.

Ejecting a Memory Card

1. Open the Memory Card Cover.
2. Slightly push the Memory Card inwards to pop it out.
3. Pull the Memory Card out of the slot and close the Memory Card Cover.

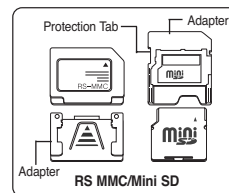
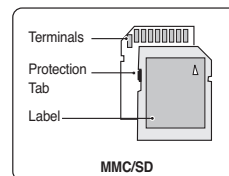

- ❖ RS MMC or Mini SD should be inserted by using the Adapter (not supplied).

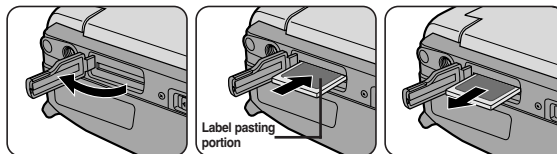

* 1GB=1,000,000,000bytes; actual formatted capacity may be less as the internal firmware uses a portion of the memory.

Digital Still Camera Mode (VP-D375W(i)/D975W(i) only)

[Notes]

- Do not apply excessive force when you insert/eject the Memory Card.
- Do not turn the power off while recording, loading, erasing a photo image or formatting the Memory Card.
- Please turn the power off before you insert or eject the Memory Card to avoid losing data.
- Do not place the Memory Card near a strong electro-magnetic device.
- Do not allow metal substances to come in contact with the terminals on the Memory Card.
- Do not bend, drop or apply strong shock to Memory Card.
- After removing the Memory Card from the camcorder, keep it in a soft case to prevent static shock.
- The data stored on the Memory Card may be changed or lost as a result of misuse, static electricity, electric noise or repair. Save important images separately. Samsung is not responsible for data loss due to misuse.
- RS-MMC or Mini SD should be inserted by using the Adaptor (not supplied).
- In M.Cam or M.Player mode, the 16:9 wide mode is not supported.
The wide mode only displays in the aspect ratio of 4:3.
- The Camcorder supports up to 2GB SD/MMC and lower. SD/MMC above 2GB may not record or play properly.

Structure of Folders and Files on the Memory Card

- ❖ The photo images that you recorded are saved in JPEG file format on the Memory Card.
- ❖ The moving images that you recorded are saved in MPEG4 file format on the Memory Card.
- ❖ Each file has a file number and all files are assigned to a folder.
 - A file number from DCAM0001 is sequentially assigned to each recorded image.
 - Each folder is numbered from 100SSDVC and recorded on the Memory Card.

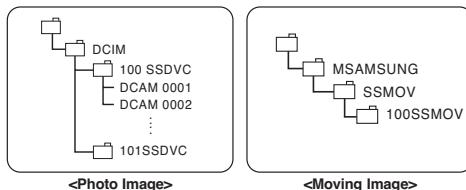

Image Format

Photo Image

- Images are compressed in JPEG (Joint Photographic Experts Group) format.
- The picture size is 800x600 or 1152x864 (VP-D975W(i) only). ➔page 75 (Tape Capture 640x480).

Moving Image

- Images are compressed in MPEG 4 (Moving Picture Experts Group) format.
- The picture size is 720X576.

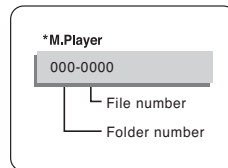

Digital Still Camera Mode (VP-D375W(i)/D975W(i) only)

Selecting the Photo Quality

- ❖ Photo Quality function works in both <Player> and <M.Cam> modes. ➔page 19
- ❖ You can select the quality of a photo image to be recorded.

Select the Image Quality

1. Set the [Power] switch to [CAMERA] or [PLAYER].
2. If the [Power] switch is set to [CAMERA], set the [Mode] switch to [CARD].
If the [Power] switch is set to [PLAYER], set the [Mode] switch to [TAPE].
3. Press the [MENU] button.
 - The menu list will appear.
4. Press the [▲ / ▼] button to select <Memory>, then press the [OK] button.
5. Press the [▲ / ▼] button to select <Photo Quality>, then press the [OK] button.
6. Press the [▲ / ▼] button to select the desired image quality <Super Fine>, <Fine>, <Normal>, then press the [OK] button.
7. To exit, press the [MENU] button.
 - The selected icon is displayed.

Number of Images on the Memory Card

QUALITY	Photo Size	128MB	512MB	2GB
<Super Fine>	800x600	Approx. 600	Approx. 2400	Approx. 9740
	*1152x864	Approx. 300	Approx. 1200	Approx. 4850
<Fine>	800x600	Approx. 790	Approx. 3150	Approx. 12800
	*1152x864	Approx. 400	Approx. 1580	Approx. 6400
<Normal>	800x600	Approx. 1270	Approx. 5070	Approx. 20000
	*1152x864	Approx. 640	Approx. 2530	Approx. 10000

- The Measured figures above are based on 800x600 Photo Size.
- * 1152X864 : VP-D975W(i) only

[Notes]

- You can directly access the Photo Quality function using the [Q.MENU] button. ➔page 20
- The number of images that can be stored on a Memory Card depends on various conditions.
- Photo images (JPEG) can be stored in the memory card up to 20,000 files.

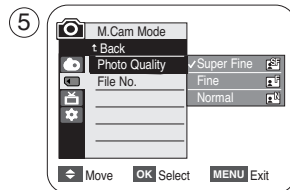
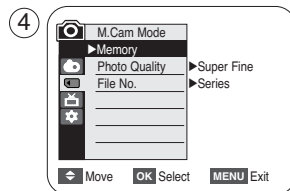
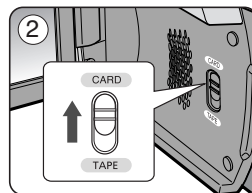

Digital Still Camera Mode (VP-D375W(i)/D975W(i) only)

Selecting the recording Photo Size (VP-D975W(i) only)

- ❖ Photo Size function works only in <M.Cam> mode. →page 19
- ❖ You can set the photo image size to meet your needs.

1. Set the **[Power]** switch to the **[CAMERA]**.
2. Set the **[Mode]** switch to **[CARD]**.
3. Press the **[MENU]** button.
 - The menu list will appear
4. Press the **[▲ / ▼]** button to select <Memory>, then press the **[OK]** button.
5. Press the **[▲ / ▼]** button to select <Photo Size>, then press the **[OK]** button.
6. Press the **[▲ / ▼]** button to select <1152 x 864> or <800 x 600>, then press the **[OK]** button.
7. To exit, press the **[MENU]** button.
 - The selected icon is displayed.

[Notes]

- Photo images that are recorded at 1152X864 on your camcorder, may not playback properly on other digital devices that do not support this photo size.
- High resolution images use more memory than lower resolution images. Therefore the higher the resolution selected the fewer will be the number of images available.

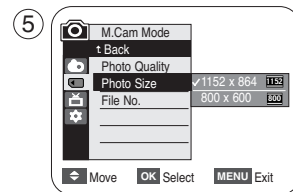
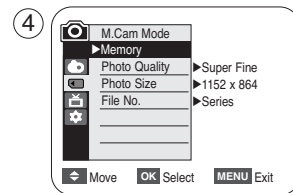
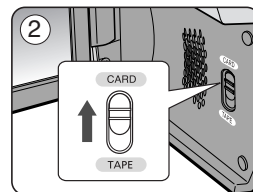

Digital Still Camera Mode (VP-D375W(i)/D975W(i) only)

Setting the File Number

- ❖ File Number setting works only in <M.Cam> mode. ↪page 19
- ❖ File Numbers are given to images in the order they were recorded when they are stored on the Memory Card.
- ❖ File numbers may be set as follows:
 - <Series> : When there are existing files, the new image will be named as the next number in the sequence.
 - <Reset>: When there are no files stored on the Memory Card, the file numbering starts from 0001.

1. Set the [Power] switch to the [CAMERA].
2. Set the [Mode] switch to [CARD].
3. Press the [MENU] button.
 - The menu list will appear
4. Press the [▲ / ▼] button to select <Memory>, then press the [OK] button.
5. Press the [▲ / ▼] button to select <File No.>, then press the [OK] button.
6. Press the [▲ / ▼] button to select the desired option <Series> or <Reset>, then press the [OK] button.
7. To exit, press the [MENU] button.

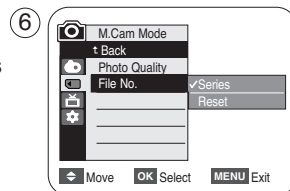
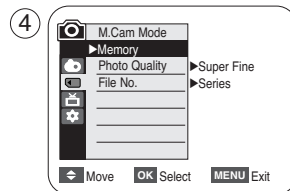

[Note]

When you set <File No.> to <Series>, each file is assigned with a different number so as to avoid duplicating file names. It is convenient when you want to manage your files on a PC.

Digital Still Camera Mode (VP-D375W(i)/D975W(i) only)

Taking a Photo Image (JPEG) on the Memory Card

- ❖ You may take photo images while in <M.Cam> mode and store the images on the Memory Card.
➡page 19
- ❖ You can take photo images using the remote control.
- ❖ Audio will not be recorded with a photo image onto the Memory Card.

1. Set the **[Power]** switch to **[CAMERA]**.
2. Set the **[Mode]** switch to **[CARD]**.
3. After framing your object to record, fully press the **[PHOTO]** button to take the picture.
 - The picture is taken and saved into the Memory Card within a few seconds.
 - Taking another picture within this interval is not possible.
 - The < [] > indicator appears during the time it takes to save the image.

[Notes]

- Photo images are saved more widely than have been taken in LCD screen.
- Photo images are saved in the Memory Card in an 800x600 or 1152x864 (VP-D975W(i) only) format.
- The number of photo images that can be stored depends on the quality of the image.
- Photo images (JPEG) can be stored in the memory card up to 20,000 files.

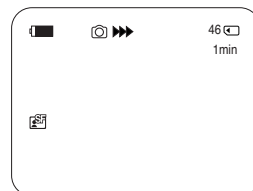
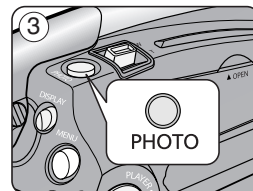
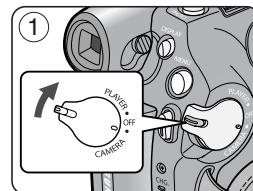

Digital Still Camera Mode (VP-D375W(i)/D975W(i) only)

Viewing Photo Images (JPEG)

- ❖ This function works only in <M.Player> mode. ➔page 19
You can play back and view photo images recorded on the Memory Card.
 - ❖ Be sure that the <M.Play Select> is set to <Photo> in the Menu. ➔page 85
1. Set the [Power] switch to [PLAYER].
 2. Set the [Mode] switch to [CARD].
 - The last recorded image appears. If there are no recorded images on the Memory Card, <No image!> is displayed.

To view a Single Image

Using the [◀◀] (REV/FWD)] buttons, search for the desired photo image.

- To view the next image: press the [▶▶] (FWD)] button.
- To view the previous image: press the [◀◀] (REV)] button.
- Keep pressing [▶▶] (FWD)] or [◀◀] (REV)] to search for an image quickly.

To view a Slide Show

Press the [▶▶] (S.SHOW)] button.

- All images will be played back consecutively for 2~3 seconds each.
- The <Slide> is displayed. The Slide Show will start from the current picture.

To stop the slide show, press the [▶▶] (S.SHOW)] button again.

To view the Multi Display

To view six stored images on single screen, press the [■] (MULTI)] button.

- A selection mark [◀◀] appears under the image.
- Press the [◀◀] (REV/FWD)] button to select an image.

To return to single playback mode, press the [■] (MULTI)] button again.

- Selected picture is displayed in full screen.

[Notes]

- Any large sized image taken with another device will be displayed as a thumbnail image.
- To display the previous six images, press and hold the [◀◀] (REV)] button for about 3 seconds.
- To display the next six images, press the [▶▶] (FWD)] button for about 3 seconds.
- You can access <Delete>, <Delete All>, <Protect> or <Print Mark> functions in Multi Display view mode, using the [Q.MENU] button.

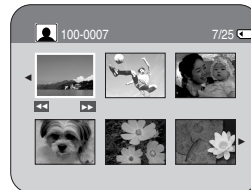
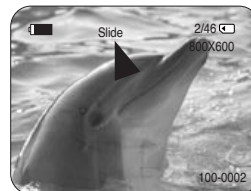
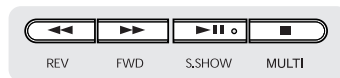

Digital Still Camera Mode (VP-D375W(i)/D975W(i) only)

Protection from accidental Erasure

- ❖ The Protection function works only in <M.Player> mode. ➡page 19
- ❖ You can protect important images from accidental erasure.
If you format the Camcorder, all images including protected images will be erased.

1. Set the [Power] switch to [PLAYER].
2. Set the [Mode] switch to [CARD].
 - The last recorded image appears.
 - If there are no recorded images on the Memory Card, <No image!> is displayed.
3. Using the [◀▶] (REV/FWD) buttons, search for the photo image that you want to protect.
4. Press the [MENU] button.
 - The menu list will appear.
5. Press the [▲ / ▼] button to select <Memory>, then press the [OK] button.
6. Press the [▲ / ▼] button to select <Protect>, then press the [OK] button.
7. Press the [▲ / ▼] button to select <On>, then press the [OK] button.
8. To exit, press the [MENU] button.
 - The protection (🔒) icon is displayed.

[Notes]

- You can directly access the Protection function using the [Q.MENU]. ➡page 20
- If the write protection tab on the Memory Card is set to LOCK, you cannot set image protection.

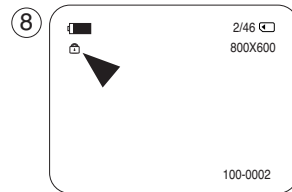
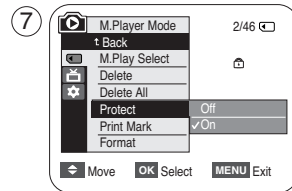
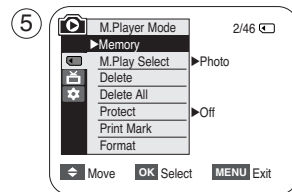

Digital Still Camera Mode (VP-D375W(i)/D975W(i) only)

Deleting Photo Images and Moving Images

- ❖ The Delete function works only in <M.Player> mode. ↪page 19
- ❖ You can erase the photo images and moving images recorded on the Memory Card.
- ❖ If you want to delete protected images, you must first deactivate the image protection.
- ❖ An image which has been deleted cannot be recovered.

1. Set the [Power] switch to [PLAYER].
2. Set the [Mode] switch to [CARD].
 - The last recorded image appears.
 - If there are no recorded images on the Memory Card, <No image!> is displayed.
3. Using the [◀◀▶▶] (REV/FWD) buttons, search for the photo image that you want to delete.
4. Press the [MENU] button.
 - The menu list will appear.
5. Press the [▲ / ▼] button to select <Memory>, then press the [OK] button.
6. Press the [▲ / ▼] button to select <Delete>, then press the [OK] button.
 - A message <Do you want to delete?> is displayed.
7. Press the [▲ / ▼] button to select <Yes> or <No>, then press the [OK] button.
8. To exit, press the [MENU] button.

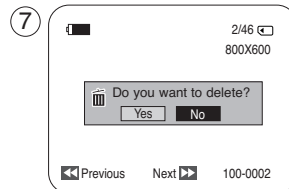
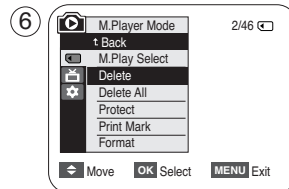
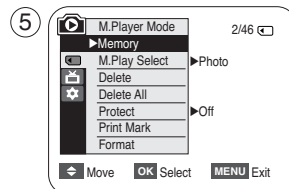

Digital Still Camera Mode (VP-D375W(i)/D975W(i) only)

Deleting All Images at Once

❖ Steps from 1 to 5 are the same as described in page 80.

6. Press the **[▲ / ▼]** button to select **<Delete All>**, then press the **[OK]** button.
 - A message **<Do you want to delete all?>** is displayed.
7. Press the **[▲ / ▼]** button to select **<Yes>** or **<No>**, then press the **[OK]** button.
8. To exit, press the **[MENU]** button.

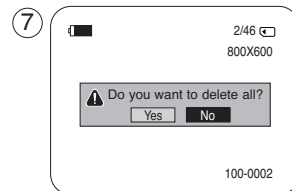
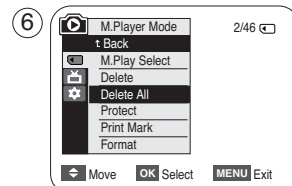

[Notes]

- You can directly access the Delete function using the **[Q.MENU]**. ➔page 20
- When there is no stored picture on the Memory Card, the message **<No image !>** will be displayed.
- If an erroneous image file is found on the Memory Card, the message **<Memory Card Error !>** will be displayed. It may be caused by copying images from different digital devices.
- Formatting the Memory Card will delete all the stored images. ➔page 82
- To protect important pictures from accidental deletion, activate the image protection. ➔page 79
- Deleting all files using the **<Delete All>** menu may take a while.
 - To delete all files much faster, format the Memory Card after backing up the files onto another storage device.

Digital Still Camera Mode (VP-D375W(i)/D975W(i) only)

Formatting a Memory Card

- ❖ The Format function works only in <M.Player> mode. ➡page 19
- ❖ You can use the Format functions to completely delete all images and options on the Memory Card, including protected images.
- ❖ The Format function restores the Memory Card to its initial state.

Attention

- ❖ If you execute the Format function, all images will be erased completely and erased images cannot be recovered.

1. Set the [Power] switch to [PLAYER].
2. Set the [Mode] switch to [CARD].
3. Press the [MENU] button.
 - The menu list will appear.
4. Press the [▲ / ▼] button to select <Memory>, then press the [OK] button.
5. Press the [▲ / ▼] button to select <Format>, then press the [OK] button.
 - A message <All files will be deleted! Do you want to format?> is displayed.
6. Press the [▲ / ▼] button to select <Yes> or <No>, then press the [OK] button.
 - <Complete !> is displayed when the format is completed.
7. To exit, press the [MENU] button.

[Notes]

- If you execute the Format function, all photo images/moving images will be erased completely and erased photo images/moving images cannot be recovered.
- Formatting the Memory Card using a different device will cause Memory Card read errors.
- Do not turn the power off in the middle of the formatting.
- A Memory Card with the protection tab set to save will not be formatted. ➡page 72
- Do not format the Memory Card on a PC.
- <Not formatted !> message may appear if a Memory Card formatted on a PC is inserted.

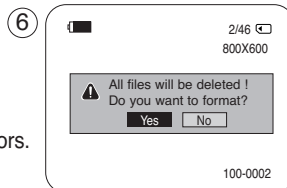
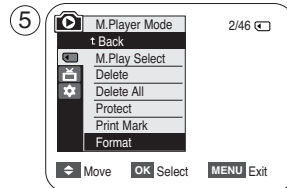
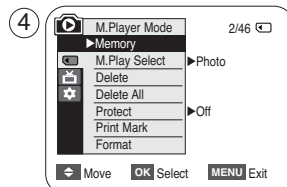

Digital Still Camera Mode (VP-D375W(i)/D975W(i) only)

Recording Moving Images (MPEG) on a Memory Card

- ❖ You may record moving images while in <M.Cam> mode and store the images on a Memory Card. ➔page 19
- ❖ You can record moving images with audio on a Memory Card.
- ❖ The screen format of the moving image to be recorded is 720X576.

Saving Moving Images onto a Memory Card

1. Set the [Power] switch to [CAMERA].
2. Set the [Mode] switch to [CARD].
3. Press the [Start/Stop] button, the moving images are recorded on the Memory Card in MPEG4.
 - You can record a photo image on Memory Card by pressing the [PHOTO] button instead of the [Start/Stop] button. ➔page 77
4. Press the [Start/Stop] button to stop the recording.

Recording time available on the Memory Card

	128MB	256MB	512MB	1GB	2GB
Moving Image	Approx. 8min	Approx. 16min	Approx. 32min	Approx. 64min	Approx. 120min

[Notes]

- These figures are approximate as recording capacities can be affected by variables such as subject matter and memory card type.
- The files that you recorded are saved in a following folder.

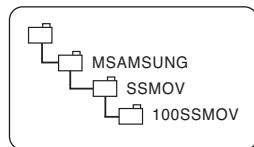
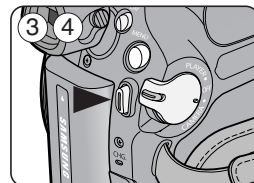
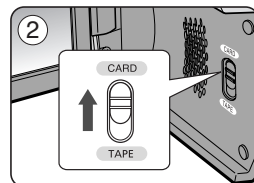
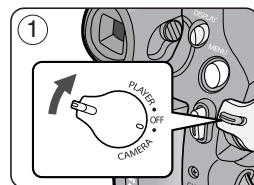

<Moving image>

Digital Still Camera Mode (VP-D375W(i)/D975W(i) only)

[Notes]

- Up to 2000 MPEG files can be stored on a memory card.
- MPEG files (Moving images) can be recorded up to 2 GB per a moving file.
- **[MENU] button and [OK] button are not available while recording a moving image. To use [MENU] button and [OK] button, stop recording. Recording a moving image is not available when a MENU or QUICK MENU is displayed on the screen. To start recording, press the [MENU] button or [Q.MENU] button to make the menu disappear.**
- Before using the Recording a moving image function, check whether the Memory Card is inserted into the Camcorder.
- Moving images that you recorded are saved in *.avi (avi 1.0) file format on the Memory Card.
- The moving images on a Memory Card are a smaller size and lower definition than images on tape.
- The sound is recorded in mono.
- The following functions are not allowed in **<M.Cam>** Mode. DIS (Digital Image Stabilizer), Digital Zoom, Fade, Program AE, Visual Effect.
- While recording on a Memory Card, don't insert or eject the tape as it may record noise.
- While recording on a Memory Card, don't eject the Memory Card or it may break the data on the Memory Card or Memory Card itself.
- Turning the power off while accessing the Memory Card may damage the data stored on the Memory Card.

Digital Still Camera Mode (VP-D375W(i)/D975W(i) only)

Playing the Moving Images (MPEG) on a Memory Card (M.Play Select)

- ❖ The Moving Images Playback function works only in <M. Player> mode. →page 19
 - ❖ You can play the moving images on a Memory Card.
 - ❖ The playback picture will be of higher quality if it is viewed on a PC rather than on a TV.
1. Set the [Power] switch to [PLAYER].
 2. Set the [Mode] switch to [CARD].
 3. Press the [MENU] button.
 - The menu list will appear.
 4. Press the [▲/▼] button to select <Memory>, then press the [OK] button.
 5. Press the [▲/▼] button to select <M.Play Select>, then press the [OK] button.
 6. Press the [▲/▼] button to select <Movie>, then press the [OK] button.
 7. To exit the menu, press the [MENU] button.
 8. Using the [◀▶] (REV/FWD) buttons, search for the moving image that you want to play back.
 - Use the [▲/▼] button to adjust the volume.
 9. Press the [▶] (PLAY/STILL) button.
 - The moving images recorded on the Memory Card will be played back.
 - You can control playback using the [▶] (PLAY/STILL), [◀▶] (REV/FWD) and [■] (STOP) buttons.

[Notes]

- You can directly access the M.Play Select function using the [Q.MENU] button. →page 20
 - [MENU] button and [OK] button are not available during moving image playback. To use [MENU] button and [OK] button, stop playback.
- Moving image playback is not available when a MENU or QUICK MENU is displayed on the screen. To start playback, press [MENU] button or [Q.MENU] button to make it disappear.**
- There may be broken or mosaic pictures while playing the moving images, but it is not a malfunction.
 - The moving images that you recorded on the Memory Card may not play on other manufacturer's equipment.
 - The moving images recorded by another Camcorder may not play on this Camcorder.
 - To play back moving images on a PC, the Video Codec (in the CD provided with the camcorder) should be installed.
 - You need Microsoft Windows Media Player Version 9 or higher version in order to play moving images on the Memory Card on your PC.
 - You can download the Microsoft Windows Media Player with your desired language from the Microsoft Website, "<http://www.microsoft.com/windows/windowsmedia/download/default.asp>".

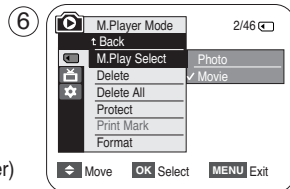
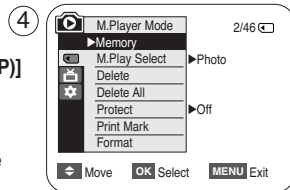
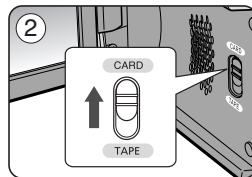

Digital Still Camera Mode (VP-D375W(i)/D975W(i) only)

Recording Photo Image from a Cassette

- ❖ This function works only in <Player> mode. ↗page 19
- ❖ You can capture a frame on a tape and save it as a Photo on a Memory Card.

1. Set the **[Power]** switch to **[PLAYER]**.
2. Set the **[Mode]** switch to **[TAPE]**.
3. Play back the cassette.
4. Press the **[PHOTO]** button.
 - The photo image is recorded on the Memory Card.
 - During the time it takes to save an image, the playback screen is paused and the OSD is displayed.

[Notes]

- Photo images copied from the cassette to the Memory Card are saved in 640x480 format.
- Number of images you can save varies depending on the image resolution.

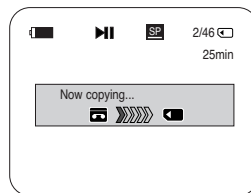
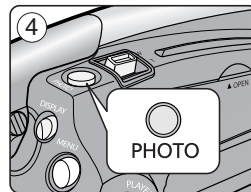

Digital Still Camera Mode (VP-D375W(i)/D975W(i) only)

Copying Still Images from a Cassette to a Memory Card (Photo Copy)

- ❖ The Photo Copy function works only in <Player> mode. ➔page 19
- ❖ You can copy all still images recorded with the Photo function from the cassette to a Memory Card.
- ❖ Rewind the tape to the desired point.

1. Set the [Power] switch to [PLAYER].
2. Set the [Mode] switch to [TAPE].
3. Press the [MENU] button.
 - The menu list will appear.
4. Press the [▲ / ▼] button to select <Tape>, then press the [OK] button.
5. Press the [▲ / ▼] button to select <Photo Copy>, then press the [OK] button.
 - All still images recorded on the cassette tape will be copied onto a Memory Card.
6. The Camcorder automatically performs the still image search to find still images and copy starts.
7. Press the [■ (STOP)] button to stop copying.
 - Copy stops when the cassette is finished or Memory Card is full.

[Note]

Still images copied from the cassette to the Memory Card are saved in 640x480 format.

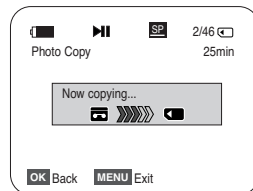
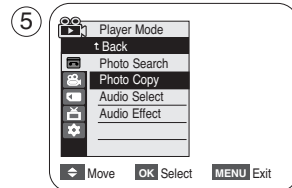
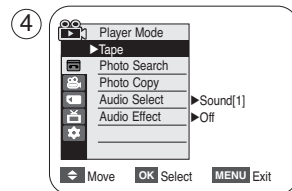

Digital Still Camera Mode (VP-D375W(i)/D975W(i) only)

Marking Images for Printing (Print Mark)

- ❖ The Print Mark function works only in <M.Player> mode. ➔page 19
- ❖ This Camcorder supports the DPOF (Digital Print Order Format) print format.
- ❖ You can automatically print images recorded on a Memory Card with a printer supporting DPOF.
- ❖ There are 2 ways to make a Print Mark.
 - <This File> : You can set a print mark on the image displayed on the LCD Screen. It can be set up to 999.
 - <All Files> : To print 1 copy each of all of the stored images.

1. Set the [Power] switch to [PLAYER].
2. Set the [Mode] switch to [CARD].
 - The last recorded image appears.
3. Using the [◀◀/▶▶] (REV/FWD) buttons, search for the photo image that you want to mark.
4. Press the [MENU] button.
 - The menu list will appear.
5. Press the [▲/▼] button to select <Memory>, then press the [OK] button.
6. Press the [▲/▼] button to select <Print Mark>, then press the [OK] button.
7. Press the [▲/▼] button to select the desired option <All Off>, <This File> or <All Files>, then press the [OK] button.
8. If you select <This File>, press the [▲/▼] button to select the quantity, then press the [OK] button.
9. To exit, press the [MENU] button.

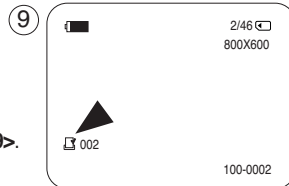
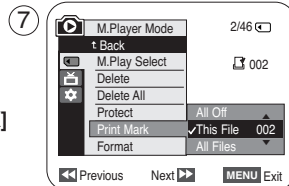
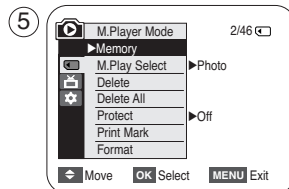

Removing the Print Mark

To remove all Print Marks, select <All Off>.

To remove an individual file's Print Mark, select the file and set <This File> to <000>.

[Notes]

- You can directly access the Print Mark function using the [Q.MENU] button. ➔page 20
- If the Print Mark is set to <This File>, you can set the number of copies from <000> to <999>.
- If the Print Mark is set to <All Files>, you can set the number of copies to <001>.
- The <All Files> option may require extended operation time depending on the number of stored images.
- DPOF supported printers are commercially available.

PictBridge™ (VP-D375W(i)/D975W(i) only)

Printing Your Pictures – Using the PictBridge™

- ❖ PictBridge™ function works only in <M.Player> mode. ➔page 19
- ❖ By connecting the Camcorder to printers with PictBridge support (sold separately), you can send images from the Memory Card directly to the printer with a few simple operations.
- ❖ With the PictBridge Support, you can control the printer directly through your Camcorder in order to print out stored pictures. For direct printing of your stored pictures using the PictBridge function, you must connect your Camcorder to a PictBridge printer using a USB cable.

Connecting To a Printer

1. Turn your printer's power off.
 - Turn your Camcorder on by setting the [Power] switch to [PLAYER].
2. Set the [Mode] switch to [CARD].
3. Press the [MENU] button.
 - The menu list will appear.
4. Press the [▲ / ▼] button to select <System>, then press the [OK] button.
5. Press the [▲ / ▼] button to select <USB Connect>, then press the [OK] button.
6. Press the [▲ / ▼] button to select <Printer>, then press the [OK] button.
 - <Computer> : Connect to a computer.
 - <Printer> : Connect to a printer. (To use the PictBridge function, connect to a printer.)
7. Connect your Camcorder to the printer using the provided USB cable.
8. Turn your printer power on.
 - The PictBridge menu screen appears automatically after a short period.
 - The cursor highlights <Print>.

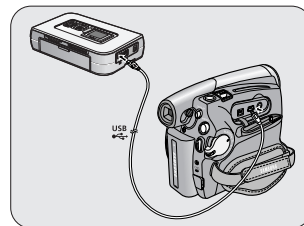
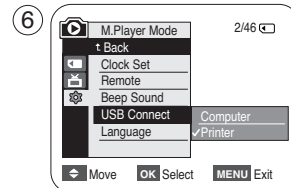
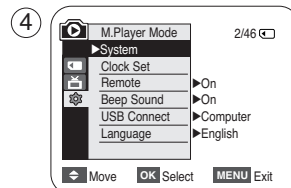

PictBridge™ (VP-D375W(i)/D975W(i) only)

Selecting Images

1. In the <PictBridge> settings menu, press the [◀◀▶▶] (REV/FWD) buttons to select an image to print.

Setting the Number of Prints

2. Press the [▲ / ▼] button to select <Copies>, then press the [OK] button.
3. Press the [▲ / ▼] button to set the number of prints, then press the [OK] button.

Setting the Date/Time Imprint Option

4. Press the [▲ / ▼] button to select <Date/Time>, then press the [OK] button.
5. Press the [▲ / ▼] button to select the Date/Time display type, then press the [OK] button.
 - Date/Time display type: <Off>, <Date>, <Time>, <Date&Time>

Printing Images

Press the [▲ / ▼] button to select <Print>, then press the [OK] button, and selected image files will be printed.

Canceling the Printing

To cancel the image printing, press [OK] button again.
The message “Cancel” appears and the image printing will be canceled.

[Notes]

- The Date/Time Imprint Option may not be supported by all printers. Check with your printer manufacturer. The <Date/Time> menu cannot be setup if the printer does not support this option.
- The PictBridge™ is a registered trademark of CIPA (Camera & Imaging Products Association), an image transfer standard developed by Canon, Fuji, HP, Olympus, Seiko Epson, and Sony.
- PictBridge supporting printers are commercially available.
- Use the USB cable provided with the Camcorder.
- Use the AC power adapter for your Camcorder during PictBridge Direct Printing. Turning your Camcorder off during printing might damage data on the Memory Card.
- Printing photo images is supported. Moving images are not available for printing.
- You can set various printing options depending on the printer.
- Please refer to the user's manual of the printer for details.

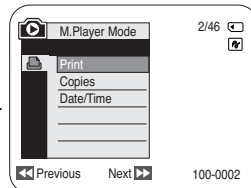
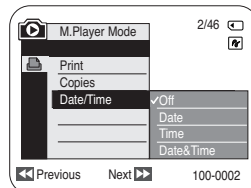
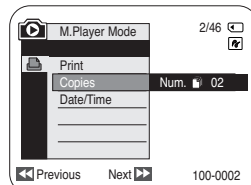

IEEE 1394 Data Transfer

Transferring IEEE1394 (i.LINK)-DV Standard Data Connections

Connecting to a DV Device (DVD Recorder, Camcorder, etc.)

- Connecting to other standard DV products.
 - A standard DV connection is quite simple.
 - If a product has a DV jack, you can transfer data by connecting to the DV jack using the correct cable. (not supplied)

!!! Please be careful since there are two types of DV jacks (4pin, 6pin). This Camcorder has a 4pin jack.

- With a digital connection, video and audio signals are transmitted in digital format, allowing high quality images to be transferred.

Connecting to a PC

- If you want to transmit data to a PC, you must install an IEEE 1394 add-on card into the PC. (not supplied)
- The frame rate for moving images is dependent on the capacity of the PC.

System Requirements

- CPU : faster Intel® Pentium III™ 450MHz compatible.
- Operating system : Windows® 98SE, ME, 2000, XP, VISTA(32bit), Mac OS (9.1~10.4)
- Main memory : more than 64 MB RAM
- IEEE1394 add-on card or built in IEEE1394 card

[Notes]

- Operation is not guaranteed for all the recommended computer environments mentioned above.
- IEEE 1394 is an international standard standardized by the Institute of Electrical and Electronics Engineers.
- DV device that does not complies with the DV standard specification may not supported.
Refer to the product documentation of the device to be connected for further details on notes and compatible software applications.

IEEE 1394 Data Transfer

Recording with a DV Connection Cable (VP-D371i/D371Wi/D372WHi/D375Wi/D975Wi only)

- ❖ Models with a 'i' suffix do feature DV(IEEE1394)/AV(Analog) In.
- 1. Set the **[Power]** switch to **[PLAYER]**.
- 2. Set the **[Mode]** switch to **[TAPE]**. (VP-D375W(i)/D975W(i) only)
- 3. Connect the DV cable (not supplied) from the DV jack of the Camcorder to the DV jack of the other DV device.
 - Make sure that **DV** is displayed.
- 4. Press the **[Start/Stop]** button to begin REC PAUSE mode.
 - **<PAUSE>** is displayed.
- 5. Start playback on the other DV device while you monitor the picture.
- 6. Press the **[Start/Stop]** button to start recording.
 - If you want to pause recording momentarily, press the **[Start/Stop]** button again.
- 7. To stop recording, press the **[STOP]** button.

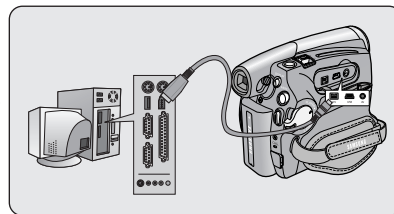

VP-D371(i)/D371W(i)/
D372WH(i)

VP-D375W(i)/D975W(i)

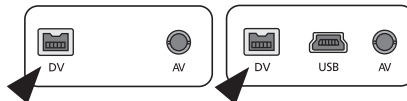

[Notes]

- When you transmit data from the Camcorder to another DV device, some functions may not work. If this occurs, please reconnect the DV cable or turn the power OFF and ON again.
- When you transmit data from the Camcorder to PC, PC function button is not available in **<M.Player>** mode.
- Do not use another DV device when using IEEE1394.
- Do not connect the Camcorder to a PC using both DV and USB (VP-D375W(i)/D975W(i) only) cables. It may not operate properly.
- The IEEE1394 cable (DV cable) is sold separately.
- Moving image software is commercially available.
- Most DV enabled PCs have a 6 pin jack. In this case, a 6pin/4pin cable is required for the connection.
- Most DV enabled Notebooks and Laptops have a 4 pin socket. Use a 4pin/4pin cable for the connection.
- DIS and COLOUR NITE features are not available when in DV (IEEE1394) mode. If DV (IEEE1394) mode is set, DIS and COLOUR NITE modes will be released.
- Search (Forward/Reverse) is not available when in DV (IEEE1394) mode.
- When using this Camcorder as a recorder, the pictures that appear on a monitor may seem uneven, however recorded pictures will not be affected.

USB Interface (VP-D375W(i)/D975W(i) only)

Using USB Interface

Transferring a Digital Image through a USB Connection

- ✦ The Camcorder supports both USB 1.1 and 2.0 standards. (Depends on the PC specification)
- ✦ You can transfer a recorded file on a Memory Card to your PC via a USB connection.
- ✦ If you transfer data to a PC, you need to install the software (DV Driver, Video Codec, DirectX 9.0) supplied with the Camcorder.



USB Connection Speed depending on the System

High speed USB connection is supported by Microsoft (Windows) device drivers only.

- Windows 2000 - High speed USB on a system with Service Pack 4 or later installed.
- Windows XP - High speed USB on a system with Service Pack 1 or later installed.
- Windows VISTA - High speed USB on a system with Service Pack 1 or later installed.

System Requirements

	Windows System
CPU	Intel® Pentium 4™, 2GHz
OS(Operating System)	Windows® 2000/XP/VISTA(32bit) * Standard installation is recommended. Operation may not assured if the above OS has been upgraded.
Memory	512MB
HDD capacity	2GB or more
Resolution	1024 x 768 dots 24bit Colour
USB	USB2.0 High Speed

- USB interface is not supported on Windows® VISTA(64bit) and Macintosh operating systems.
- System requirements mentioned above are recommendations. Even on a system that satisfies the requirements may not ensure the operation depending on the system.

[Notes]

- On a slower PC than recommended, movie playback may not be smooth or video editing may take a long time.
- On a slower PC than recommended, movie playback may skip frames or operate unexpectedly.
- Intel® Pentium III™ or Pentium 4™ is a trademark of the Intel Corporation.
- Windows® is a registered trademark of the Microsoft® Corporation.
- All other brands and names are property of their respective owners.
- Operations are not guaranteed for all of the recommended computer environments mentioned above.
- Do not connect the Camcorder to a PC using both DV and USB cables. It may not operate properly.
- In **<M.Cam>** or **<M.Player>** mode, be sure that the Memory Card is inserted into Camcorder before connecting USB cable.
If no Memory Card or an unformatted Memory Card is inserted, PC will not recognize your Camcorder as a removable disk.
- USB Streaming requires Video Codec, DV Driver and DirectX 9.0.
- If you disconnect the USB cable from the PC or the Camcorder during the data transfer, the data transfer will stop and the data may be damaged.
- If you connect the USB cable to a PC using a USB HUB or with other devices at the same time, it may cause conflict and may not work properly. If this occurs, remove all other USB devices and try the connection again.

USB Interface (VP-D375W(i)/D975W(i) only)

Selecting the USB Device (USB Connect)

- ❖ USB Connect function works only in <M.Player> mode. ➔page 19
- ❖ Using the USB cable, you can connect your Camcorder to a computer to copy your moving images and photo images from the Memory Card, or to a printer to print your images.

1. Set the [Power] switch to [PLAYER].
2. Set the [Mode] switch to [CARD].
3. Press the [MENU] button.
 - The menu list will appear.
4. Press the [▲ / ▼] button to select <System>, then press the [OK] button.
5. Press the [▲ / ▼] button to select <USB Connect>, then press the [OK] button.
6. Press the [▲ / ▼] button to select <Computer> or <Printer>, then press the [OK] button.
 - You can select <Computer> to use the Camcorder as a PC Camera, USB Stream or removable disk.
 - You can select <Printer> to use the Pictbridge feature. ➔page 89
7. To exit, press the [MENU] button.

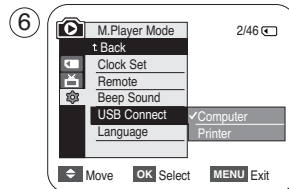
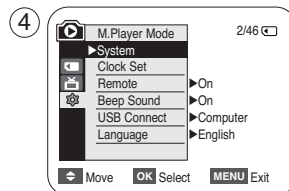
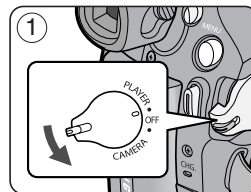

USB Interface (VP-D375W(i)/D975W(i) only)

Installing DV Media PRO Program

- ❖ To play back moving images recorded by the Camcorder or streaming data transferred through the USB connection on a PC, the Video Codec program should be installed.
- ❖ Do not connect the Camcorder to PC before installing the program.
- ❖ If another Camcorder or scanner is connected, please disconnect it in advance.
- ❖ This explanation is based on Windows® 2000 OS.
- ❖ DV Media Pro User's Manual is included on the accompanying CD(D:/help/) in Adobe's Portable Document Format (PDF). (The Acrobat Reader is a freeware product of AdobeSystems,Inc.)
DV Media Pro User's Manual is in English.

Program Installation

1. Insert the software CD into the CD-ROM drive of your computer.
 - Installation selection screen appears.
2. If the installation selection screen does not appear after inserting the CD, click "Run" in the Windows "Start" menu and execute Autorun.exe file to begin installation. When CD-ROM drive is set to "D:drive", type "D:/autorun.exe" and press Enter.
3. Click the icons listed below to install the selected software.
 - DV Driver Click
 - PC CAMERA & USB STREAMING Driver (CAPTURE DRIVER)
 - Connect a Camcorder to your PC to complete the DV Driver installation.
 - 1) This function works only in Camera mode.
 - 2) Connect the camcorder to the PC using the USB cable.
 - 3) The SAMSUNG A/V Capture driver installation begins on the PC.
 - DirectX 9.0 Click
 - Video Codec Click

The Video Codec needs to be installed in order to play the moving images (stored in the Memory Card) on a PC or to use the USB Streaming/PC Camera functions.

USB Interface (VP-D375W(i)/D975W(i) only)

Connecting to a PC

1. Connect a USB cable to the USB jack on the PC.
 - If a USB cable is connected to the Camcorder's USB jack, the Audio/Video Cable is disabled.
2. Connect the other end of the USB cable into the USB jack on the Camcorder. (USB jack)
 - If PC is connected with the USB to the Camcorder, only the **[Power]** switch, **[Mode]** switch, **[Zoom]** lever can be operated.

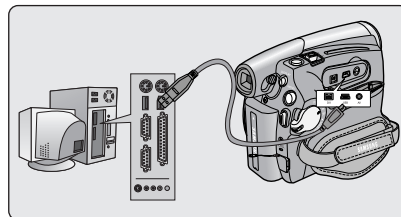

Disconnecting the USB Cable

- ❖ After completing the data transmission, you must disconnect the cable in the following way:
1. Select the removable disc icon and click the right mouse button to select <Eject>.
 2. Select <Confirm> and disconnect the USB cable when the Windows Splash screen appears.

[Notes]

- If you disconnect the USB cable from the PC or the Camcorder while transferring, the data transmission will stop and the data may be damaged.
- If you connect the USB cable to a PC via a USB HUB or simultaneously connect the USB cable along with other USB devices, the Camcorder may not work properly. If this occurs, remove all USB devices from the PC and reconnect the Camcorder.

USB Interface (VP-D375W(i)/D975W(i) only)

Using the PC Camera Function

- ❖ This function works only in <Camera> mode. ➔page 19
- ❖ To use the PC Camera function, DV Driver, Video Codec and DirectX 9.0 programs must be installed in the PC.
- ❖ When you connect to a Web site that provides video chatting functions, you can use your Camcorder to participate.
- ❖ When using this camcorder for video conferencing (such as Net Meeting), voice communication may not be supported depending on the video conferencing software. In this case, connect an external microphone to the soundcard of the PC to enable voice communication.
- ❖ Using the Camcorder with PC Net Meeting program installed, you can participate in video conference.
- ❖ The PC Camera's screen size (Transferred video frame rate for the PC Camera function is max 12.5 fps.)
 - 640X480 (VGA) pixels for USB 2.0 connection.
- ❖ If PC is connected with the USB to the Camcorder, only the **[Power]** switch, **[Mode]** switch, **[Zoom]** lever and **[W / T]** Button can be operated.

1. Set the **[Power]** switch to **[CAMERA]**.
2. Set the **[Mode]** switch to **[TAPE]**.
3. Connect one end of the USB cable to the USB jack on the Camcorder and the other end to the USB connector on your computer.

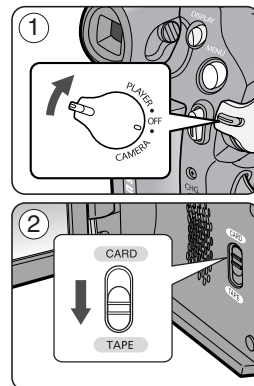

USB Interface (VP-D375W(i)/D975W(i) only)

Using the USB Streaming Function

- ❖ This function works in both <Camera> and <Player> modes. ➔page 19
 - ❖ To use USB streaming, the DV Driver, Video Codec and DirectX 9.0. programs must be installed in the PC.
 - ❖ You can view Camcorder video on your PC using USB streaming.
 - ❖ You can also store it as a moving image in the "avi" file format, or as a photo image in the "jpg" file format on a PC.
1. Set the **[Power]** switch to **[CAMERA]** or **[PLAYER]**, set the **[MODE]** switch to **[TAPE]**.
 2. Connect one end of the USB cable to the USB jack on the Camcorder and the other end to the USB jack on your computer.
 3. Setup and execute Windows Movie Maker or the Ulead VIDEO Studio Software application provided on the CD.
 - For detailed instructions for Ulead VIDEO Studio use, refer to the program's Help function.
 - Windows Movie Maker is used for Windows® XP users. (C:/program files/Movie maker/moviemk.exe)

Using the removable Disk Function

- ❖ You can easily transfer data from a Memory Card to a PC without additional cards via a USB connection.
1. Set the **[Power]** switch to **[CAMERA]** or **[PLAYER]**, set the **[Mode]** switch to **[CARD]**.
 2. Connect one end of the USB cable to the USB jack on the Camcorder and the other end to the USB jack on your computer.
 3. To verify whether the removable disk has been properly recognized, open Windows Explorer and locate the removable disk.

Maintenance

After Finishing a Recording

- ❖ At the end of a recording you must remove the power source.
- ❖ When recording with a Battery Pack, leaving the pack on the Camcorder can reduce the life span of the battery.

The Battery Pack should be release after recording is completed.

1. Open the Cassette door while sliding the **[TAPE EJECT]** switch in the direction of the arrow.
 - Pull the cassette compartment out automatically.
 - Please wait while the tape is completely ejected.
2. After removing the tape, close the door and store the Camcorder in a dust free environment. Dust and other foreign materials can cause square-shaped noise or jerky images.
3. Set the **[Power]** switch to the **[OFF]**.
4. Disconnect the power source or remove the Battery Pack. Press the **[BATTERY RELEASE]** switch located on the bottom of the Camcorder and slide the Battery Pack in the direction of the arrow.

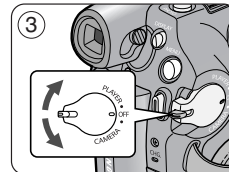
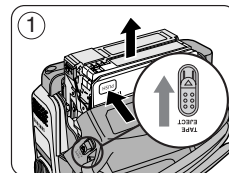

Usable Cassette Tapes

When you have recorded something that you wish to keep, you can protect it so that it will not be accidentally erased.

- a. Protecting a tape: Push the safety tab on the cassette so that the hole is uncovered.
- b. Removing the tape protection:

If you no longer wish to keep the recording on the cassette, push the safety tab back so that it covers the hole.

How to store a tape

- a. Avoid places with magnets or magnetic interference.
- b. Avoid humidity and dust prone places.
- c. Keep the tape in an upright position and avoid storing it in direct sunlight.
- d. Avoid dropping or knocking your tapes.

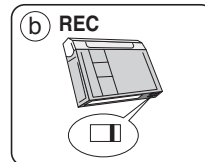
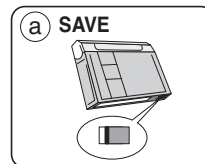

Maintenance

Cleaning and Maintaining the Camcorder

Cleaning the Video Heads

To ensure normal recording and clear pictures, clean the video heads when the playback pictures display square block-shaped noise or distortion, or a blue screen appears.

1. This function works only in **<Player>** mode. ➔page 19
2. Set the **[Mode]** switch to **[TAPE]**. (VP-D375W(i)/D975W(i) only)

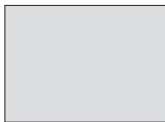
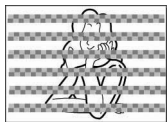

(blue screen)

3. Insert a cleaning tape.
4. Press the **[▶II (PLAY/STILL)]** button.
5. Press the **[■ (STOP)]** button after 10 seconds.

[Notes]

- Check the quality of the picture using a videocassette.
 - If the picture quality has not improved, repeat the operation.
- Clean the video heads with a dry type cassette cleaner.
- Some cleaning cassette products stop automatically. Refer to the cleaning cassette's instructions for detailed information. If the problem continues after the cleaning, consult your nearest Samsung dealer or Authorized Service Centre. (blue screen)

Maintenance

Using Your Camcorder Abroad

- ❖ Each country or region has its own electric and colour systems.
- ❖ Before using your Camcorder abroad, check the following items.

Power sources

- You can use your Camcorder in any country or area with the supplied AC Power adapter within 100V to 240V, 50/60 Hz.
- Use a commercially available AC jack adapter, if necessary, depending on the design of the local wall outlet.

Colour system

You can view your recording in the Viewfinder.

However, to view it on a television or copy it to a videocassette recorder, the television or VCR must be PAL-compatible and have the appropriate audio/video jacks. Otherwise, you may need to use a transcoder.

PAL-compatible Countries/Regions

Australia, Austria, Belgium, Bulgaria, China, CIS, Czech Republic, Denmark, Egypt, Finland, France, Germany, Greece, Great Britain, Holland, Hong Kong, Hungary, India, Iran, Iraq, Kuwait, Libya, Malaysia, Mauritius, Norway, Romania, Saudi Arabia, Singapore, Slovak Republic, Spain, Sweden, Switzerland, Syria, Thailand, Tunisia, etc.

NTSC-compatible Countries/Regions

Bahamas, Canada, Central America, Japan, Korea, Mexico, Philippines, Taiwan, United States of America, etc.

[Note]



You can make recordings with your Camcorder and view pictures on the LCD Screen from anywhere in the world.

Troubleshooting

Troubleshooting

- ❖ Before contacting a Samsung authorized service centre, perform the following simple checks. They may save you the time and expense of an unnecessary call.

Self Diagnosis Display

Display	Blinking	Informs that...	Action
	slow	The Battery pack is almost discharged.	Change to a charged one.
Tape end!	slow	When the remaining time on the tape is about 2 minutes.	Prepare a new one.
Tape end!	no	The tape reached its end.	Change to a new one.
No Tape!	slow	There is no tape in Camcorder.	Insert a tape.
Protection!	slow	The tape is protected from recording.	If you want to record, release the protection.
▲...D L C R	slow	The Camcorder has some mechanical fault.	1. Eject the tape. 2. Set to OFF. 3. Detach the battery. 4. Reattach the battery. * If unresolved contact your local Samsung service centre.
	slow	Moisture condensation has formed in the Camcorder.	see below.

Moisture Condensation

- If the Camcorder is brought directly from a cold place to a warm place, moisture may condense inside the Camcorder, on the surface of the tape, or on the lens. In this condition, the tape may stick to the head drum and be damaged or the unit may not operate correctly.
To prevent possible damage under these circumstances, the Camcorder is fitted with a moisture sensor.
- If there is moisture inside the Camcorder,  (DEW) is displayed.
If this happens, none of the functions except cassette ejection will work.
Open the cassette compartment and remove the Battery.
Leave the Camcorder for at least two hours in a dry warm room.

Troubleshooting

Self Diagnosis Display in M.Cam/M.Player Modes (VP-D375W(i)/D975W(i) only)

Display	Blinking	Informs that..	Action
No Memory Card !	slow	There is no Memory Card in the Camcorder.	Insert a Memory Card.
Memory full !	slow	There is not enough memory to record.	Change to a new Memory Card. Erase recorded image.
No image !	slow	There are no images recorded on the Memory Card.	Record new images.
Write protect !	slow	The Memory Card is record protected.	Release the write protect tab on the Memory Card.
Protect !	slow	When you try to delete to protected image.	Cancel the protection of image.
Read error !	slow	The Camcorder can not playback.	Format a Memory Card or insert Memory Card recorded on this Camcorder.
Write error !	slow	The Camcorder can not record.	Format a Memory Card or change to a new Memory Card.
Not formatted !	slow	The Memory Card needs to format.	Format a Memory Card. (see page 82)
Now deleting...	slow	When progressing file delete.	Wait until delete has been finished.
Memory Card Error !	slow	If inserted Memory Card is not recognized by the Camcorder.	Eject and re-insert the memory card Try another Memory Card

Troubleshooting

❖ If these instructions do not solve your problem, contact your nearest Samsung authorized service centre.

Symptom	Explanation/Solution
You cannot switch the Camcorder on.	Check the Battery pack or the AC Power adapter.
Start/Stop button does not operate while recording.	Check the Power switch is set to CAMERA. You have reached the end of the cassette. Check the record protection tab on the cassette.
The Camcorder shuts off automatically.	You have left the Camcorder set to STBY for more than 5 minutes without using it. The Battery pack is fully exhausted.
Charge runs out quickly.	The atmospheric temperature is too low. The Battery pack has not been charged fully. The Battery pack is completely dead, and cannot be recharged, Use another Battery pack.
You see a blue screen during playback.	The video heads may be dirty. Clean the head with a cleaning tape.
A vertical strip appears on the screen when recording a dark background.	The contrast between the subject and the background is too great for the Camcorder to operate normally. Make the background bright to reduce the contrast or use the BLC function while you are recording in bright Surroundings.
The image in the Viewfinder is blurred.	The Viewfinder lens has not been adjusted. Adjust the Viewfinder control lever until the indicators displayed on the Viewfinder come into sharp focus.
Auto focus does not work.	Check the Manual Focus menu. Auto focus does not work in the Manual Focus mode.
Play, FF or REW button does not work.	Check the Power switch. Set the Power switch to PLAYER. You have reached the beginning or end of the cassette.
You see a mosaic pattern during playback search.	This is normal operation and it is not a failure or defect. The tape may be damaged. Replace the tape. Cleaning the video heads (see page 100).

Troubleshooting

Setting menu items

Main Menu	Sub Menu	Functions	Available Mode				Page
			Camera	Player	M-Cam ①	M-Player ①	
Camera	Program AE	Selecting the Program AE Function	✓				48, 49
	White Balance	Setting the White Balance	✓		✓		50
	Visual Effect	Setting the Digital special effect	✓				52, 53
	16:9 Wide	Setting the 16:9 Wide Function	✓				54
	Macro	Setting the Macro Function	✓		✓		55
	DIS	Selecting the Digital Image Stabilizing	✓				56
	BLC	Setting the BLC Function	✓		✓		57
	Digital Zoom	Selecting the Digital Zoom	✓				58
Tape	Photo Search	Searching pictures recorded in Tape		✓			59
	Photo Copy	Copying still images from a cassette to Memory Card		✓			87
	Audio Select	Selecting the Audio playback channel		✓			64
	Audio Effect	Selecting the Audio Effect		✓			68
Record	Rec Mode	Selecting the recording speed	✓	✓			43
	Audio Mode	Selecting Sound Quality for recording	✓	✓			43
	WindCut Plus	Minimizing wind noise	✓	✓			44
	Real Stereo	Selecting the Real Stereo	✓				45
	AV In/Out ②	Selecting the AV input/output		✓			69
Memory ①	Photo Quality	Selecting Image Quality		✓	✓		74
	Photo Size ③	Selecting the recording Photo Size			✓		75
	File No.	File Numbering Options			✓		76
	M.Play Select	Selecting Storage Media (Photo, Movie) to playback				✓	85
	Delete	Deleting Files				✓	80
	Delete All	Deleting All files				✓	81
	Protect	Preventing Accidental Erasure				✓	79
	Print Mark	Print images recorded on a Memory Card				✓	88
	Format	Formatting the Memory Card				✓	82

① : VP-D375W(i)/D975W(i) only

② : VP-D371i/D371Wi/D372WHi/D375Wi/D975Wi only

③ : VP-D975W(i) only

Troubleshooting

Main Menu	Sub Menu	Functions	Available mode				Page
			Camera	Player	M-Cam ①	M-Player ①	
Display	LCD Bright	Setting the Brightness tone of the LCD Screen	✓	✓	✓	✓	29
	LCD Colour	Setting the Colour tones of the LCD Screen	✓	✓	✓	✓	29
	Date/Time	Setting the Date and Time	✓	✓	✓	✓	30
	TV Display	Selecting OSD on/off of TV	✓	✓	✓	✓	31
System	Clock Set	Setting the Clock Set	✓	✓	✓	✓	23
	Remote ①	Using the remote control	✓	✓	✓	✓	24
	Beep Sound	Setting the Beep sound	✓	✓	✓	✓	25
	Shutter Sound ①	Setting the Shutter sound	✓	✓	✓		26
	USB Connect ①	Setting the USB				✓	94
	Language	Selecting the OSD language	✓	✓	✓	✓	27
	Demonstration	Demonstration	✓				28

① : VP-D375W(i)/D975W(i) only

This Owners Manual covers the complete range of VP-DXXX digital video camcorders including non DV(IEEE1394)/AV(Analog) In and DV(IEEE1394)/AV(Analog) In versions of the same models. Please note that models without a 'i' suffix do not feature DV(IEEE1394)/AV(Analog) In.

Models with a 'i' suffix do feature DV(IEEE1394)/AV(Analog) In.

Specifications

Model Name: VP-D371(i)/D371W(i)/D372WH(i)/D375W(i)/D975W(i)

System	
Video signal	PAL
Video recording system	2 rotary heads, Helical scanning system
Audio recording system	Rotary heads, 12/16b PCM system
Usable cassette	Digital video tape (6.35mm width): Mini DV cassette
Tape speed	SP: approx. 18.83mm/s LP: approx. 12.57mm/s
Tape recording time	SP: 60 minutes (when using DVM 60), LP: 90 minutes (when using DVM 60)
FF/REW time	Approx. 150 sec. (using DVM60 tape)
Image device	CCD (Charge Coupled Device) (VP-D371(i)/D371W(i)/D372WH(i)/D375W(i) : 800K Pixels, VP-D975W(i) : 1MEGA Pixels)
Lens	F1.6 34X (VP-D371(i)/D371W(i)/D372WH(i)/D375W(i)), 26X (VP-D975W(i)), 1200x (Digital) Electronic zoom lens
Filter diameter	Ø30
LCD Screen/Viewfinder	
Size/dot number	2.5inch 112K (VP-D371(i)), 2.7inch 112K (VP-D371W(i)/D372WH(i)/D375W(i)/D975W(i))
LCD Screen Method	TFT LCD
Viewfinder	Colour LCD
Connectors	
Video output	1Vp-p (75Ω terminated)
Audio output	-7.5dBs (600Ω terminated)
DV input/output	4pin special in/out connector
USB output	Mini-B type connector
(VP-D375W(i)/D975W(i) only)	
General	
Power source	DC 8.4V, Lithium Ion Battery Pack 7.4V
Power source type	Lithium Ion Battery Pack, Power supply (100V~240V) 50/60Hz
Power consumption	3.5W(VP-D371/D371W(i)/D372WH(i)/D375W(i))
(Recording)	3.9W(VP-D975W(i))
Operating temperature	0°~40° C (32° F~104° F)
Storage temperature	-20° C ~ 60° C (-4° F ~ 140° F)
External dimension	Height : 3.70inches (94mm), Length : 4.69inches (119mm), Width : 2.16inches (55mm)
Weight	0.75lb (340g, 11.99oz) (Except for Lithium Ion Battery Pack and tape)
Internal Microphone	Omni-directional stereo microphone
Remote control	Indoors: greater than 49ft(15m) (straight line), Outdoors: about 16.4ft(5m) (straight line)
(VP-D375W(i)/D975W(i) only)	

- The technical specifications and design may be changed without notice.

Index**- A -**

Accessories	8
AF/MF	47
Audio Dubbing	63
Audio Mode	43

- B -

Battery Pack	16
BLC	57

- C -

Cassette	32
Cleaning	100
Clock Set	23
Connecting	96

- D -

Date/Time	30
DC Cable	19
Deleting	80~81
Demonstration	28
DIS	56
DV	92

- E -

EASY.Q Mode	35
Exposure	46

- F -

Fade	40
Formatting	82
Frame advance	62
Function buttons	9

- H -

Hand Strap	14
------------------	----

- I -

IEEE1394	91~92
----------------	-------

- L -

LCD	29
-----------	----

- M -

Memory Card	72
Moving Image Recording	83

- O -

OSD	21, 22
-----------	--------

- P -

Photo Copy	87
Photo Quality	74
Photo Size	75
Photo Search	59
Program AE	48
Protection	79
Photo images	78

- R -

Rec Mode	43
Rec Search	36
Remote	24
Remote control	13

- S -

Shutter Speed	46
Sound	25~26
Speaker	60

- T -

Tele Macro	55
TV Display	31

- U -

USB (VP-D375W(i)/D975W(i) only)	93~98
---------------------------------------	-------

- V -

Viewfinder	32
Voice+	67
Visual Effect	52

- W -

White Balance	50
WindCut Plus	44

- Z -

ZERO MEMORY	37
Zoom	39

Power Sources (United Kingdom Only)

The mains lead on the power adapter is supplied with a moulded plug incorporating a fuse.

The value of the fuse is indicated on the pin face of the plug and, if it requires replacing, a fuse approved to BS1362 of the same rating must be used.

Never use the plug with the fuse cover omitted if the cover is detachable.

If a replacement fuse cover is required, it must be of the same colour as the pin face of the plug.

Replacement covers are available from your dealer.

If the fitted plug is not suitable for the power points in your house or the cable is not long enough to reach a power point, you should obtain a suitable safety approved extension lead or consult your dealer for assistance.

However, if there is no alternative to cutting off the plug, remove the fuse and then safely dispose of the plug.

Do NOT connect the plug to a mains socket as there is a risk of shock hazard from the bared flexible cord.

IMPORTANT

The wires in the mains lead are coloured in accordance with the following code:

BLUE = NEUTRAL BROWN = LIVE

As these colours may not correspond to the coloured markings identifying the terminals in your plug, proceed as follows:

The wire coloured BLUE must be connected to the terminal marked with the letter N or coloured BLUE or BLACK.

The wire coloured BROWN must be connected to the terminal marked with the letter L or coloured BROWN or RED.

[**WARNING**] Do not connect either wire to the earth terminal marked with the letter E or the earth symbol, , or coloured GREEN or GREEN and YELLOW.

[**NOTE**] This page is applicable to Great Britain only.



UNITED KINGDOM

This Samsung product is warranted for the period of twelve (12) months from the original date of purchase, against defective materials and workmanship. In the event that warranty service is required, you should return the product to the retailer from whom it was purchased.

However, Samsung Authorised Dealers and Authorised Service Centres in other EC Countries will comply with the warranty on the terms issued to purchasers in the country concerned. In case of difficulty, details of our Authorised Service Centres are available from:

Samsung Electronics U.K. Ltd.

Customer Care Centre

PO Box 17243

Edinburgh, EH11 4YB

United Kingdom

Tel: 0870 SAMSUNG (7267864), Fax: 0870 7221127

(United Kingdom)

Tel: 0818 717 100, Fax: +44 (0)870 7221127

(Republic of Ireland)

Web: www.samsung.com/uk

■ WARRANTY CONDITIONS

1. The warranty is only valid if, when warranty service is required, the warranty card is fully and properly completed and is presented with the original invoice or sales slip or confirmation, and the serial number on the product has not been defaced.
2. Samsung's obligations are limited to the repair or, at its discretion, replacement of the product or the defective part.
3. Warranty repairs must be carried out by Authorised Samsung Dealers or Authorised Service Centres. No reimbursement will be made for repairs carried out by non Samsung Dealers and, any such repair work and damage to



REPUBLIC OF IRELAND

the products caused by such repair work will not be covered by this warranty.

4. This product is not considered to be defective in materials nor workmanship by reason that it requires adaptation in order to conform to national or local technical or safety standards in force in any Country other than the one for which the product was originally designed and manufactured. This warranty will not cover, and no reimbursement will be made for such adaptation nor any damage which may result.
5. This warranty covers none of the following:
 - a) Periodic check ups, maintenance and repair or replacement of parts due to normal wear and tear.
 - b) Cost relating to transport, removal or installation of the product.
 - c) Misuse, including the failure to use this product for its normal purposes or incorrect installation.
 - d) Damage caused by Lightning, Water, Fire, Acts of God, War, Public Disturbances, incorrect mains voltage, improper ventilation or any other cause beyond the control of Samsung.
6. This warranty is valid for any person who legally acquired possession of the product during the warranty period.
7. The consumers statutory rights in any applicable national legislation whether against the retailer arising from the purchase contract or otherwise are not affected by this warranty. Unless there is national legislation to the contrary, the rights under this warranty are the consumers sole rights and Samsung, its subsidiaries and distributors shall not be liable for indirect or consequential loss or any damage to records, compact discs, videos or audio taper or any other related equipment or material.

SAMSUNG ELECTRONICS (U.K.) LTD.

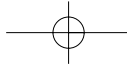



ΕΛΛΑΣ (GREECE)

Αγαπητέ πελάτη,

Σας ευχαριστούμε για την εμπιστοσύνη που δείξατε στην **SAMSUNG** με την αγορά αυτής της συσκευής.

Το προϊόν αυτό της **SAMSUNG** είναι εγγυημένο για περίοδο δώδεκα (12) μηνών από την ημερομηνία αγοράς του για ανταλλακτικά και εργατικά. Στην περίπτωση που θα χρειαστεί επισκευή, το προϊόν αυτό της **SAMSUNG** θα πρέπει να σταλεί ή να μεταφερθεί στο εξουσιοδοτημένο **service**, με έξοδα του αγοραστή.

Εξουσιοδοτημένοι αντιπρόσωποι και εξουσιοδοτημένα κέντρα **service** σε άλλες Ευρωπαϊκές χώρες, θα αποδεχθούν τους όρους της εγγύησης.

Πληροφορίες για τα εξουσιοδοτημένα κέντρα **service** στην Ελλάδα, μπορείτε να πάρετε από την

FOURLIS TRADE A.E.B.E.

Λ. Κρουονιέρου 112

145 68 Κρουονίρι, Αττικής

Τηλ. 210.629.3100

■ Όροι της εγγύησης

1. Η εγγύηση ισχύει εάν και μόνο εάν το προϊόν χρειάζεται **service** και η κάρτα εγγύησης έχει πλήρως συμπληρωθεί και σφραγισθεί από το κατάστημα αγοράς. Επίσης πρέπει να προσκομισθεί και το τιμολόγιο ή η απόδειξη λιανικής πώλησης, πάνω στην οποία ο σειριακός αριθμός του προϊόντος πρέπει να είναι ευκρινής.
2. Η υποχρέωση της **SAMSUNG** αφορά μόνο την επισκευή του προϊόντος

3. Η επισκευή του προϊόντος πρέπει να ανατίθεται μόνο σε εξουσιοδοτημένα κέντρα **service** ή εξουσιοδοτημένους αντιπροσώπους της **SAMSUNG**. Καμία αποζημίωση δεν θα γίνει αποδεκτή για επισκευή που έχει γίνει από μη εξουσιοδοτημένο από την **SAMSUNG** συνεργείο.

4. Το προϊόν αυτό δεν θα θεωρηθεί ελαττωματικό στα υλικά ή στην εργασία επισκευής εάν θα πρέπει να προσαρμοστεί, μετατραπεί ή ρυθμιστεί ώστε να συμμορφωθεί με τις τοπικές τεχνικές προδιαγραφές ή προδιαγραφές που ισχύουν σε χώρα άλλη από αυτή για την οποία προορίζεται ή κατασκευάστηκε.

Η εγγύηση αυτή δεν καλύπτει αποζημιώσεις για:

- * Κεφαλές βίντεο και κασετοφώνων
- * Κεφαλές βιντεοκάμερας
- * Γεννήτριες ακτινών **laser** στα **CD, DVD**
- * Τηλεχειριστήρια
- * Λυχνίες φούρων μικροκυμάτων
- * Προσαρμογές, μετατροπές ή ρυθμίσεις, ανεξάρτητα αν είναι επιτυχείς ή ανεπιτυχείς, ούτε οποιαδήποτε ζημία προέρχεται εξ αυτού...

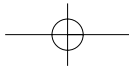

5. Η εγγύηση αυτή δεν καλύπτει καμία από τις παρακάτω περιπτώσεις:

- * Περιοδικούς ελέγχους, συντήρηση και επισκευή ή αντικατάσταση μερών που οφείλονται σε φυσιολογική φθορά
- * Τα έξοδα και τους κινδύνους μεταφοράς που σχετίζονται με την εγγύηση αυτού του προϊόντος
- * Ζημία σε αυτό το προϊόν που προέρχεται από:
 - A. Κατάχρηση ή και κακή χρήση, συμπεριλαμβανομένης αλλά και μη περιορισμένης σε:
Μη χρήση αυτού του προϊόντος για τους σκοπούς που φυσιολογικά προορίζεται ή σύμφωνα με τις οδηγίες χρήσεως για την σωστή χρήση και συντήρηση αυτού του προϊόντος
Την εγκατάσταση και χρήση του προϊόντος με τρόπους που αντίκεινται στις τεχνικές προδιαγραφές ασφαλείας που ισχύουν κατά την χρήση του προϊόντος
 - B. Επισκευή που έγινε από μη εξουσιοδοτημένα συνεργεία **service**
 - Γ. Ατυχήματα, θεομηνίες ή οποιαδήποτε αιτία πέρα του ελέγχου της **SAMSUNG**, συμπεριλαμβανομένων αλλά μη περιορισμένων των κεραυνών, του νερού, της φωτιάς, των δημοσίων αναταραχών, του κακού αερισμού κλπ.
- Δ. Η εγγύηση αυτή δεν επηρεάζει τα δικαιώματα του καταναλωτή που προβλέπονται από την εφαρμοστέα εθνική νομοθεσία που ισχύει, ούτε τα δικαιώματα των καταναλωτών εναντίον των λιανοπωλητών που απορρέουν από την σύμβαση πώλησης.

Ε. Σε περίπτωση που δεν υπάρχει εθνική νομοθεσία αυτή η εγγύηση θα είναι η μοναδική και αποκλειστική κάλυψη του καταναλωτή για κάθε ζημιά.

FOURLIS TRADE A.E.B.E.

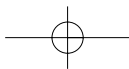

Contact SAMSUNG WORLD WIDE

If you have any questions or comments relating to Samsung products, please contact the SAMSUNG customer care centre.

Region Country	Customer	Care Centre	Web Site
North America	CANADA	1-800-SAMSUNG (7267864)	www.samsung.com/ca
	MEXICO	01-800-SAMSUNG (7267864)	www.samsung.com/mx
	U.S.A	1-800-SAMSUNG (7267864)	www.samsung.com
Latin America	ARGENTINE	0800-333-3733	www.samsung.com/ar
	BRAZIL	0800-124-421	www.samsung.com/br
	CHILE	800-726-7864(SAMSUNG)	www.samsung.com/cl
	COSTA RICA	0-800-507-7267	www.samsung.com/latin
	ECUADOR	1-800-10-7267	www.samsung.com/latin
	EL SALVADOR	800-6225	www.samsung.com/latin
	GUATEMALA	1-800-299-0013	www.samsung.com/latin
	JAMAICA	1-800-234-7267	www.samsung.com/latin
	PANAMA	800-7267	www.samsung.com/latin
	PUERTO RICO	1-800-682-3180	www.samsung.com/latin
	REP. DOMINICA	1-800-751-2676	www.samsung.com/latin
	TRINIDAD & TOBAGO	1-800-7267-864	www.samsung.com/latin
Europe	VENEZUELA	1-800-100-5303	www.samsung.com/latin
	BELGIUM	02 201 2418	www.samsung.com/be
	CZECH REPUBLIC	844 000 844	www.samsung.com/cz
	DENMARK	38 322 887	www.samsung.com/dk
	FINLAND	09 693 79 554	www.samsung.com/fi
	FRANCE	08 25 08 65 65 (0,15€ /Min)	www.samsung.com/fr
	GERMANY	01805 - 121213 (€ 0,14/Min)	www.samsung.de
	HUNGARY	06 40 985 985	www.samsung.com/hu
	ITALIA	199 153 153	www.samsung.com/it
	LUXEMBURG	02 261 03 710	www.samsung.lu
	NETHERLANDS	0900 20 200 88 (€ 0.10/Min)	www.samsung.com/nl
	NORWAY	231 627 22	www.samsung.com/no
	POLAND	0 801 801 881	www.samsung.com/pl
	PORTUGAL	80 8 200 128	www.samsung.com/pt
	SLOVAKIA	0850 123 989	www.samsung.com/sk
	SPAIN	902 10 11 30	www.samsung.com/es
	SWEDEN	08 585 367 87	www.samsung.com/se
	CIS	U.K	0870 SAMSUNG (7267864)
RUSSIA		8-800-200-0400	www.samsung.ru
Asia Pacific	UKRAINE	8-800-502-0000	www.samsung.com/ur
	AUSTRALIA	1300 362 803	www.samsung.com/au
	CHINA	800-810-5858, 010- 6475 1880	www.samsung.com.cn
	HONG KONG	2862 6001	www.samsung.com/hk
	INDIA	3030 8282 1600 1100 11	www.samsung.com/in
	INDONESIA	0800-112-8888	www.samsung.com/id
	JAPAN	0120-327-527	www.samsung.com/jp
	MALAYSIA	1800-88-9999	www.samsung.com/my
Middle East & Africa	PHILIPPINES	1800-10-SAMSUNG (7267864)	www.samsung.com/ph
	SINGAPORE	1800-SAMSUNG (7267864)	www.samsung.com/sg
	THAILAND	1800-29-3232 02-689-3232	www.samsung.com/th
	TAIWAN	0800-329-999	www.samsung.com/tw
	VIETNAM	1 800 588 889	www.samsung.com/vn
	SOUTH AFRICA	0860 7267864 (SAMSUNG)	www.samsung.com/za
	U.A.E	800SAMSUNG (7267864)	www.samsung.com/nea

ENGLISH

THIS CAMCORDER IS MANUFACTURED BY:



RoHS compliant

Our product complies with “The Restriction Of the use of certain Hazardous Substances in electrical and electronic equipment”, and we do not use the 6 hazardous materials- Cadmium(Cd), Lead (Pb), Mercury (Hg), Hexavalent Chromium (Cr⁶⁺), Poly Brominated Biphenyls (PBBs), Poly Brominated Diphenyl Ethers(PBDEs)- in our products.