

SAMSUNG TECHWIN



SALES NETWORK

• SAMSUNG TECHWIN CO., LTD.

333-1, Sangdaewon 1-dong, Jungwon-gu, Seongnam-si, Gyeonggi-do 462-807, Korea
TEL : +82-31-730-8931-3 FAX : +82-31-730-8950

• SAMSUNG OPTO-ELECTRONICS UK, LTD.

Samsung House, 1000 Hillswood Drive, Hillswood Business Park Chertsey, Surrey KT16 0PS
TEL : +44-1932-45-5308 FAX : +44-1932-45-5325

www.samsungtechwin.com
www.samsungcctv.com

P/No. : Z6806-0828-01A
VAN 07. 08



Supreme Image

128X WDR, 560TVL



Supreme Resolution WDR Camera **SHC-735** User's Manual

Thank you for purchasing a SAMSUNG CCD CAMERA.
Before attempting to connect or operate this product,
please read these instructions carefully and save this manual for future use.

ENGLISH

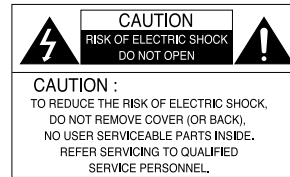

The lightning flash with an arrowhead symbol, within an equilateral triangle is intended to alert the user to the presence of uninsulated “dangerous voltage” within the product’s enclosure that may be of sufficient magnitude to constitute a risk of electric shock to persons.



The exclamation point within an equilateral triangle is intended to alert the user to the presence of important operating and maintenance (servicing) instructions in the literature accompanying the appliance.

INFORMATION - This equipment has been tested and found to comply with limits for a Class A digital device, pursuant to part 15 of the FCC Rules. These limits are designed to provide reasonable protection against harmful interference when the equipment is operated in a commercial environment. This equipment generates, uses, and can radiate radio frequency energy and, if not installed and used in accordance with the instruction manual, may cause harmful interference to radio communications.

Operation of this equipment in a residential area is likely to cause harmful interference in which case the user will be required to correct the interference at his own expense.

WARNING : Changes or modifications not expressly approved by the manufacturer could void the user’s authority to operate the equipment.

WARNING : To prevent electric shock and risk of fire hazards:

- ◆ Do NOT use power sources other than that specified.
- ◆ Do NOT expose this appliance to rain or moisture.

This installation should be made by a qualified service person and should conform to all local codes.

Contents

Features	6	How to Use the Camera	22
Precautions	8	■ Function Menu Structure	22
Components and Accessories	10	■ How to Set up the Functions	23
Overview	11	• LENS	24
■ Front View	11	• EXPOSURE	26
■ Side View	12	• WHITE BALANCE	28
■ Bottom View	13	• BACKLIGHT	29
■ Rear View	14	• SSNR	31
Installation Procedures	15	• DAY/NIGHT	32
■ Lens	15	• IMAGE ADJ	34
• When Using Auto Iris Lens		• SPECIAL	36
• When Using C/CS Mount Lens		• EXIT	40
■ Connecting a Monitor	19	Troubleshooting	41
■ Connecting Power	20	Specifications	43
■ Control via RS-485 Interface	21		

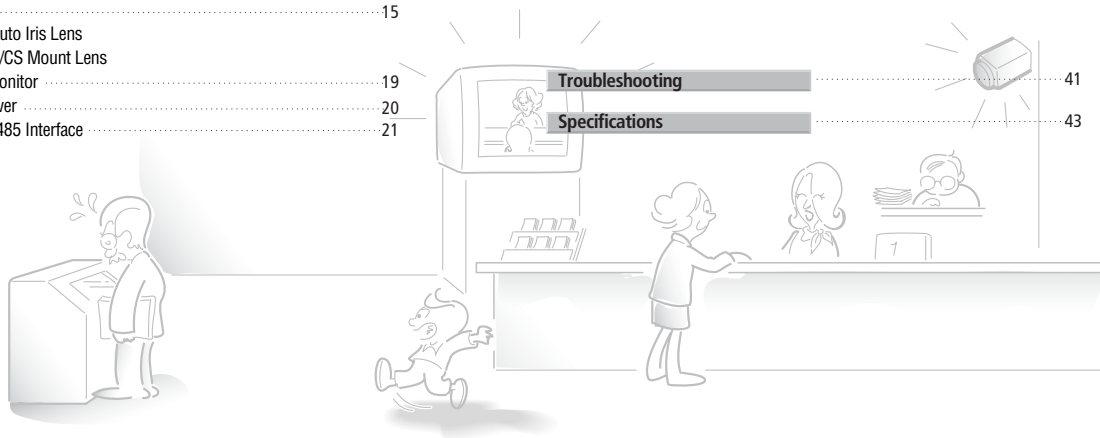

Features

Ultra High Resolution

By adopting a double-speed 410,000 pixel Sony CCD, the camera produces clear picture quality with a horizontal resolution of 560 TV lines for color, and 700 TV lines for B/W.

Wide Dynamic Range (WDR):

By adopting a proprietary SV-IV DSP chip, the camera delivers clear, high quality pictures even in backlight, by increasing exposure in dark areas while decreasing it in bright areas; a corrected image with clear details results.

Excellent Sensitivity

Adopting a Diagonal 6mm (1/3"), highly sensitive CCD and digital signal processing technology, it can clearly distinguish the outline and color of a subject in an extremely low luminance environment – even, for example, under starlight. Since surveillance is possible in places where the light is poor, the camera is appropriate for day and night surveillance outdoors or on the outside of buildings.
- 0.001 Lux (Color Sens-up Mode)
- 0.00004 Lux (B/W Sens-up Mode)

SSNR (Samsung Super Noise Reduction) Function

The high performance SV-IV DSP chip dramatically reduces the gain noise in digital image processing, producing clear, sharp images in low lighting environments.

Day & Night

The camera identifies whether it is day or night and automatically switches to the appropriate mode, depending on its environment. By day, the camera switches to color mode in order to maintain optimal color. At night, it switches to B/W mode so as to obtain better picture definition.

Motion Detection

Since the camera detects motion and generates signals without any additional external sensors, you can monitor activity more efficiently by connecting the camera to an alarm device.

DIS (Digital Image Stabilizer)

The DIS function compensates for any camera movement, to produce more stable pictures.

Video/DC Drive Lens Support

You can select Video or DC Drive Lens from the menu.

Miscellaneous Functions

SYNC (INTALL), SENS-UP, FREEZE, FLIP (HV-REV), D-ZOOM, SHARPNESS, MOTION DETECTION and PRIVACY functions are provided.

RS-485 Communication Control Support

Remote OSD menu control via an RS-485 interface is supported.

OSD

The camera control is convenient by using 7 different foreign language O.S.D.
- NTSC: Korean, English, Spanish, Japanese
- PAL: English, French, German, Spanish, Italian, Chinese



Samsung Techwin cares for the environment at all product manufacturing stages to preserve the environment, and is taking a number of steps to provide customers with more environment-friendly products. The Eco mark represents Samsung Techwin's will to create environment-friendly products, and indicates that the product satisfies the EU RoHS Directive.

Warnings & Cautions

This information is provided to ensure your safety and to prevent any losses, financial or otherwise. Please read it carefully and use the product accordingly.

* For product inquiries, please contact the retail shop where you bought the camera. The use of equipment such as an aerial ladder while providing after-sales service shall be at your expense.

Warning/Attention/Special Mark Messages



Ignoring this information may result in material loss and/or serious personal injuries including death.



Indicates "Never Allowed."



Indicates "No Disassembling."



Indicates "Must Observe."



Correct Disposal of This Product (Waste Electrical & Electronic Equipment)

(Applicable in the European Union and other European countries with separate collection systems)

This marking shown on the product or its literature, indicates that it should not be disposed with other household wastes at the end of its working life. To prevent possible harm to the environment or human health from uncontrolled waste disposal, please separate this from other types of wastes and recycle it responsibly to promote the sustainable reuse of material resources.

Household users should contact either the retailer where they purchased this product, or their local government office, for details of where and how they can take this item for environmentally safe recycling.

Business users should contact their supplier and check the terms and conditions of the purchase contract. This product should not be mixed with other commercial wastes for disposal.

Precautions

Do not install under extreme temperature conditions.



Use only under temperature conditions between -10°C and $+50^{\circ}\text{C}$. Provide good ventilation when using in high temperature conditions.

Do not install under unstable lighting conditions.

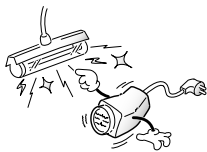

Severe lighting changes or flickering may hinder normal camera operation.

Do not install in high humidity environment.



May lower image quality.

Avoid touching the camera lens.



The lens is the most important component of the camera. Be careful not to smear it with fingerprints.

Do not drop the camera or subject it to physical shock.



May cause a product malfunction.

Do not expose the camera to rain or other types of liquids.



Wipe dry any liquids. Liquids may contain minerals that are corrosive to electronic components.

Never keep the camera face to strong light directly.



May damage the CCD.

Do not expose the camera to radioactivity.



Radioactivity exposure may damage the CCD.

Notes

- Exposure to a spotlight or an object emitting strong light may cause smear or blooming.
- Ensure that the power source complies with normal specifications before supplying it to the camera.

1. Ultra High Resolution
WDR Color CCD Camera SHC-735



2. Auto Iris Lens Connector Plug



3. C-Mount Adapter



4. Instruction Manual



5. AC 24V/500mA Adapter



Front View

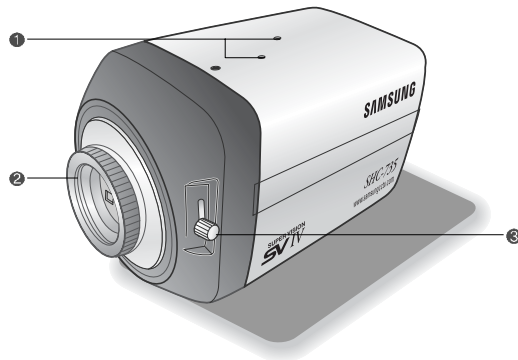

- ❶ **Tripod Mounting Bracket Screw Hole**
Used to fix the Tripod Mounting Bracket to the top of the camera.
- ❷ **C-Mount Lens Adapter**
Install this adapter to use a C-Mount Lens.
- ❸ **Back Focus Control Lever**
Adjust focus by this Back Focus Lever.

Overview

Side View

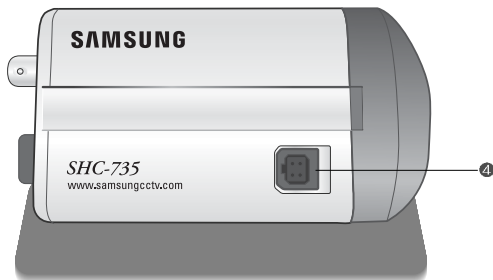

- ④ **Auto Iris Lens Connector**
Used to connect Auto Iris Lens plug.

Bottom View

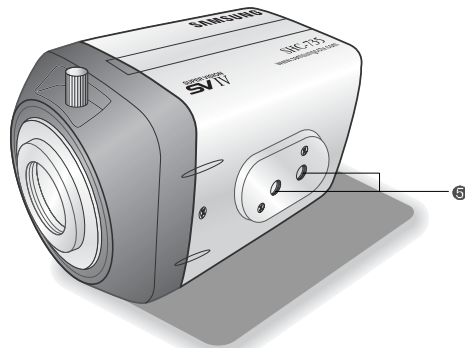

- ⑤ **Tripod Mounting Bracket Screw Hole**
Used to fix the camera on a bracket or tripod.
The screw sizes for this hole are as follows:

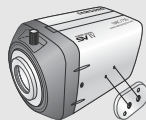
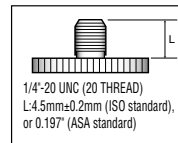

You can separate the Tripod Mounting Bracket and install it on the top or bottom of the camera.
Make sure to use the Tripod Mounting Bracket when fixing the camera to a bracket or tripod. Otherwise the camera may not be secure, or the internal circuitry of the camera may be damaged.

Rear View

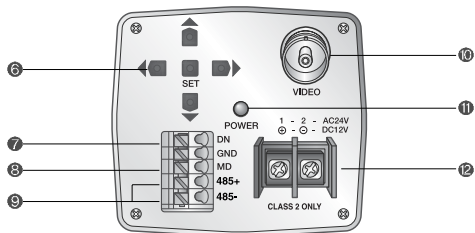

6 Function Setup Button

- **SET Button** : Displays the menu on the screen. Press this button to confirm status or after changing a selected item.
- **Up and Down Button** : Used to move the cursor up or down in the menu screen to select a desired menu item.
- **Left and Right Button** : Used to move the cursor left or right in the menu screen or to change the value of the selected item.

7 D & N Input Port

You can switch to Day & Night Mode by connecting an external signal to this port.

8 MD Output Port

Motion detection signals are output through this port.

9 RS-485 Control Port

You can control SETUP MENU through this port by using external controllers like a Remote controller that RS-485 Communication is supported. For details, see page 21.

10 Video OUT Port

Video signals are output through this port. Connect this port to the Video IN port of a monitor.

11 Power LED

When power is properly connected, this LED comes on.

12 Power IN Port

Connect the power as specified for each model here.

Lens

The lens is not supplied with this camera. Purchase a lens suitable for your environment. This camera accepts the auto iris lens and both C-and CS-mount lens.



Notes

- It is recommended to use the DC type Auto Iris Lens to effectively enjoy the major functions of this camera.
- Keep the lens surface clean, since if it is contaminated with dirt or fingerprints the picture quality suffers.

When Using Auto Iris Lens

1. Strip the insulation of the auto iris lens cable 8mm from the end.

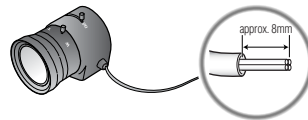

2. Strip the insulation of the core of the auto iris lens cable to expose a 2mm length.

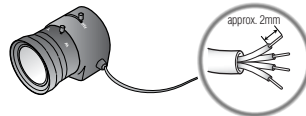

Installation Procedures

3. Remove the cover of the auto iris lens connector plug and solder the lens cable to the connector pin of the plug.

- For a Video Drive Lens
 - Pin 1: Red (Power)
 - Pin 2: NC
 - Pin 3: White (Video Signal)
 - Pin 4: Black (Ground)

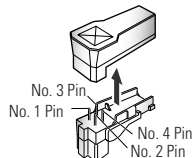

- For a DC Drive Lens
 - Pin 1: Damping -
 - Pin 2: Damping +
 - Pin 3: Drive +
 - Pin 4: Drive -

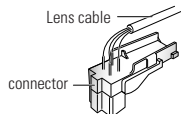

4. Fit the cover of the auto iris lens connector plug, remove the protective glass cover from the front of the camera, and fasten the auto iris lens by turning it clockwise.

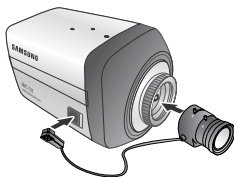

5. Set focus of camera using Back Focus Control Lever of camera side after combining Auto Iris lens.

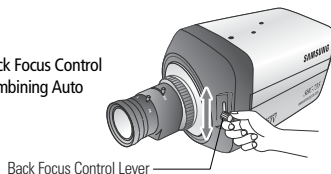

When Using C/CS Mount Lens

Before installing a lens, identify whether the lens to be installed is a C-Mount or CS-Mount. This camera is set for a CS-Mount Lens by default. To install a C-Mount Lens, a simple modification is required.

• When Using a CS Mount Lens

Remove the protective glass cover at the front of this product and turn the CS-Mount Lens clockwise to install it. And set focus of camera using Back Focus Control Lever of camera side after combining CS-Mount lens.

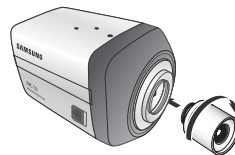

Notes

- Use the lens connector shown in the following figure. If the dimensions of the connector are not correct, it may damage the camera, or the lens may not be installed firmly.

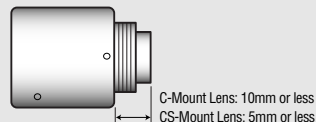

- If the lens is too heavy, the camera becomes unbalanced and there may be problems. Use a lens that weighs less than 450g.
- When adjusting the Automatic Level Control (ALC) of an auto iris lens, use Av mode if available. If you use the PK mode, the picture brightness may change continuously.

Installation Procedures

• When Using a C Mount Lens

1. Remove the protective glass cover at the front of this product and turn the C-Mount Adapter clockwise to install it.

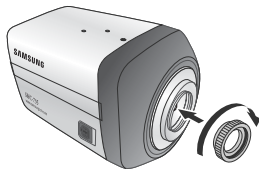

2. Turn the C-Mount lens clockwise to install it.

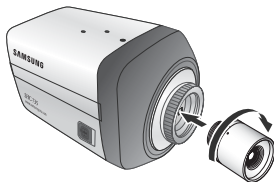

3. Set focus of camera using Back Focus Control Lever of camera side after combining C-Mount lens.

Connecting a Monitor

Connect the Video OUT port on the rear panel of the camera to a monitor.

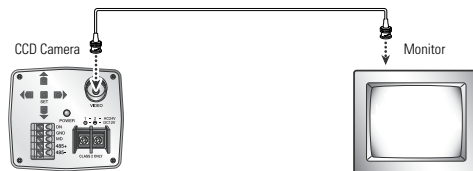

- Since the connection procedure may differ depending on the type of monitor or peripheral device to be connected, refer to the User Manual for the device to be connected.
- Make sure to turn off the device to be connected before making any connections.
- Turn the 75Ω /Hi-Z switches of interim display devices to the Hi-Z position, and the switches of any final device to the 75Ω position.

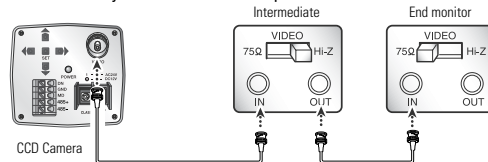

Installation Procedures

Connecting Power

Since power specifications differ depending on the model, make sure to check your model name and specifications before connecting power. You can connect power as shown in the following figure.

For AC / DC power

- Since the power specification supports both AC and DC, connect AC 24V, 500mA Adaptor or DC 12V, 500mA Adaptor.

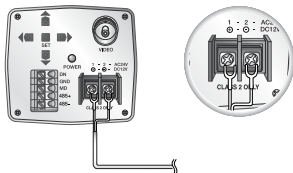

When the resistance value of copper wire is at [20°C(68°F)]

Copper wire size(AWG)	#24(0.22mm ²)	#22(0.33mm ²)	#20(0.52mm ²)	#18(0.83mm ²)
Resistance value(Ω/m)	0.078	0.050	0.030	0.018
Voltage drop(V/m)	0.028	0.018	0.011	0.006

- As shown in the table above, voltage decreases as the wire gets longer. Therefore use of an excessively long adaptor output line for connection to the camera may affect the performance of the camera.

※ Standard voltage for camera operation : DC 12V±10%, AC 24V±10%

※ There may be some deviation in voltage drop depending on the type of wire and the manufacturer.

Control via RS-485 Interface

The camera can be controlled by using external controllers like a Remote controller. (RS-485 Communication)

- (1) To control by PC
Connect the RS-485 control port of the camera and the serial cable through an RS-485 converter.
Example) PC Serial Port (COM1) → Serial Cable → RS-485 Converter → Camera RS-485 Control Port

- (2) To control using a DVR or System Controller
Connect the RS-485 cable (TRX+, TRX-) to the connection port of the 485 control board that is connected to the DVR or System Controller.

485 Control Board Connection Port	RS-485 Control Port
(+) CONNECTION TERMINAL (TRX+)	485+
(-) CONNECTION TERMINAL (TRX-)	485-

* RS-485 Communication establishment initial value

Item	Camera ID	BAUD RATE	UART MODE	PET PKT
Initial value	1	9600	8-NONE-1	ENABLE



Notes

- To control the camera by constructing an additional controller, use Pelco-D protocol or STW protocol (Samsung Techwin protocol).

How to Use the Camera

Function Menu Structure

	Setup Menu		
LENS	• DC	• VIDEO	• MANUAL
EXPOSURE	• SHUTTER	• AGC	• SENS-UP
	• RETURN		
WHITE BALANCE	• ATW	• MANUAL	• AWC → SET
	• OUTDOOR	• INDOOR	
BACKLIGHT	• OFF	• WDR	• BLC
SSNR	• ON	• OFF	
DAY/NIGHT	• COLOR	• BW	• AUTO
	• EXTERN		
IMAGE ADJUSTMENT (IMAGE ADJ.)	• FREEZ	• V-REV	• H-REV
	• D-ZOOM	• SHARPNESS	
	• RETURN		
SPECIAL	• CAMTITLE	• SYNC	• MOTION DET
	• PRIVACY	• DIS	• COMM ADJ
	• LANGUAGE	• RESET	• RETURN
EXIT			

How to Set up the Functions

You can set up functions using the 5 buttons on the rear of the camera.

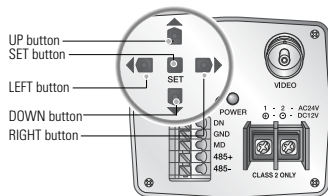

1. Press the SET button.
 - Main setup menu is displayed on the monitor screen.

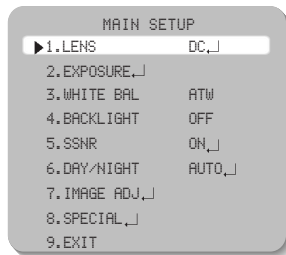

2. Select a desired function using the Up and Down buttons.
 - Place the cursor over a desired item.

How to Use the Camera

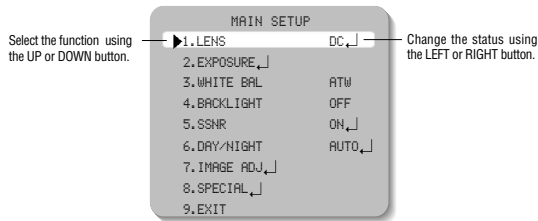

- Set up a selected item by using the Left and Right buttons.
- To finish the setting, select 'EXIT' and press the SET button.

Notes

- An item with the ◀ icon also has sub menus. To select a sub menu, select an item with the icon and press the SET button.
- An item with the - - - icon is unavailable due to function settings.

LENS

Using this function, you can control screen brightness.

- When the SETUP menu screen is displayed, select 'LENS' by using the Up and Down buttons so that the arrow indicates 'LENS'.
- Select the connected lens type by using the Left and Right buttons.

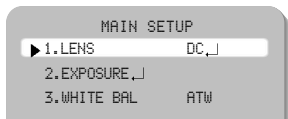

DC/Video : Select Auto Iris Lens

- When DC is selected, you can control screen brightness. The range of brightness control is between 1 and 70. Adjust the brightness appropriately for optimal screen brightness.



Notes

- Some lenses may not work properly, depending on the setting of the BRIGHTNESS LEVEL.
- When Using a Video-Type Auto Iris Lens
 - Adjust the ALC adjustment terminal on the lens appropriately. In general, set it to AV (Average).
 - It may not work properly depending on the installed lens. Set the Level VR of the lens to the optimal value.
 - Set AGC / SENS-UP to OFF and adjust the Lens VR to an appropriate brightness.
 - Adjust the Lens VR, adjust the BRIGHTNESS, and then check if the screen brightness changes properly. Otherwise, adjust the Lens VR again.

Manual : Select Manual Lens

How to Use the Camera

EXPOSURE

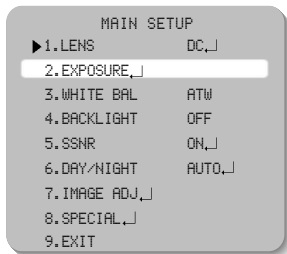

1. When the SETUP menu screen is displayed, select 'EXPOSURE' by using the Up and Down buttons so that the arrow indicates 'EXPOSURE'.
2. Select a desired mode using the Up and Down buttons.

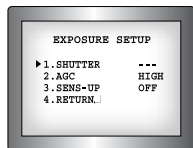

- **SHUTTER** : You can select either auto or manual shutter.
 - A.FLK : Select this when you experience picture flicker, which can happen when there is a clash with the frequency of the installed lighting.
 - ESC : Select this to control the shutter speed automatically. If ESC is selected, the shutter speed is automatically controlled depending on the ambient illumination of the subject.
 - MANUAL : You can control shutter speed manually.

Notes

- To produce better results with A.FLK, do not use it in conjunction with the WDR mode of the BACKLIGHT menu.
- When the SHUTTER is set to ESC after selecting the Internal Synchronization Type, the picture may become unstable if the camera faces a bright fluorescent light. Therefore, take care when choosing the installation position.
- ESC and MANUAL modes are only available together when the lens is set to MANUAL.
- When the SHUTTER is set to MANUAL or A.FLK mode, SENS-UP will be disabled.

● AGC (AUTO GAIN CONTROL):

The higher the gain level, the brighter the screen - but the higher the noise.

- OFF : Deactivates the AGC function.
- LOW : Allows automatic gain control from 0 to 24dB.
- HIGH : Allows automatic gain control from 0 to 42dB.

● SENS-UP :

When it is night or dark, the camera automatically detects the light level and maintains a clear picture if this mode is activated.

- OFF : Deactivates the SENS-UP function.
- AUTO : Activates the SENS-UP function.

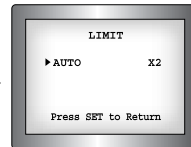

● RETURN :

Select this to save the changes in the EXPOSURE menu and return to the SETUP menu.

Notes

- If you press the SET button in 'AUTO' mode, You can adjust brightness by increasing or decreasing the shutter speed. (X2~X256)
- Note that the higher the zoom level, the brighter the screen, but the more likely it is that an after-image will appear.
- Although Noise, Spots, and Whittish symptoms may occur in SENS-UP operation when the zoom level is increased, this is normal.

How to Use the Camera

White Balance (White Bal.)

Use the White Balance function to adjust the screen color.

1. When the SETUP menu screen is displayed, select 'White Bal.' by using the Up and Down buttons so that the arrow indicates 'White Bal.'.
2. Select a desired mode using the Up and Down buttons.

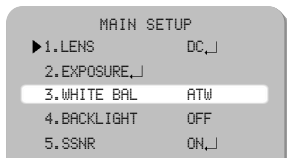

※ Select one of the following 5 modes, as appropriate for your purpose.

- ⌚ ATW : Select this when the color temperature is between 1800°K and 10500°K
- ⌚ INDOOR : Select this when the color temperature is between 4500°K and 8500°K.
- ⌚ OUTDOOR : Select this when the color temperature is between 1800°K and 10500°K. (sodium light inclusion)
- ⌚ AWC → SET : To find the optimal setting for the current luminance environment in this mode, set the point the camera towards a sheet of white paper and press the SET button. If the environment changes, readjust it.
- ⌚ MANUAL : Select this to fine-tune White Balance manually. Set White Balance first by using the ATW or AWC mode. After that switch to MANUAL mode, fine-tune the White Balance and then press the SET button.



Notes

• White Balance may not work properly under the following conditions. In this case select the AWC mode.

- ① When the color temperature of environment surrounding the subject is out of the control range (e.g. clear sky, or sunset)
- ② When the ambient illumination of the subject is dim.
- ③ If the camera is directed towards a fluorescent light or is installed in a place where illumination changes dramatically, the White Balance operation may become unstable.

BACKLIGHT

This camera is designed so that it delivers a distinctive subject and background at the same time, even when the subject is in backlight, unlike conventional cameras, by adopting a proprietary SV-IV DSP chip.

1. When the SETUP menu screen is displayed, select 'BACKLIGHT' by using the Up and Down buttons so that the arrow indicates 'BACKLIGHT'.

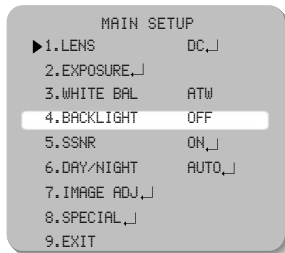

2. Select a desired mode using the Left and Right buttons depending on the camera purpose.

How to Use the Camera

- ☉ WDR : When there are both bright and dark areas at the same time, this mode makes both areas distinctive.
- ☉ OFF : Deactivates the WDR function.

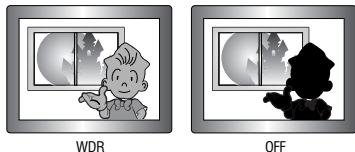

- ☉ BLC : Enables a user to directly select a desired area from a picture, and to view the area more clearly.

3. Select a desired mode using the Left and Right buttons and press the SET button.
 - Select 'WDR' to adjust the WDR LIMIT. Select LOW, MIDDLE, or HIGH.

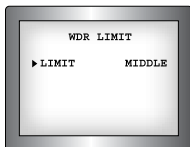

- Select 'BLC' to adjust the area to be enhanced by the WDR function.

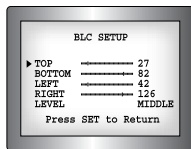

Notes

- You cannot use the WDR mode when MANUAL or A.FLK mode in 'SHUTTER' menu is selected.
- Since the following symptoms may occur according to the ambient illumination when WDR is selected, set it to OFF.
 - ☉ Color or screen changes unnaturally.
 - ☉ Noise appears in the bright part of the screen.
- Since the performance of the WDR function may be affected by the area of the bright part of the screen, optimize the installation angle for the best WDR performance.
- If you increase LIMIT, the screen display may be distorted.
- For high performance of WDR function, using DC Iris lens rather than manual lens is recommended.

SSNR

This function reduces the background noise in a low luminance environment.

1. When the SETUP menu screen is displayed, select 'SSNR' by using the Up and Down buttons so that the arrow indicates 'SSNR'.

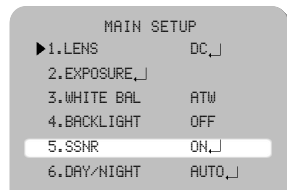

2. Select a desired mode using the Left and Right buttons.
 - ☉ OFF : Deactivates SSNR. Noise is not reduced.
 - ☉ ON : Activates SSNR so that noise is reduced.

How to Use the Camera

- Set the SSNR mode to 'ON' and press the SET button. Then you can adjust the noise reduction level.



Notes

- You cannot set the SSNR to 'ON' or 'OFF' when the AGC mode of the EXPOSURE menu is 'OFF'.
- When adjusting the noise reduction level of the SSNR mode, remember that the higher the level set, the more the noise level will be reduced but that after image may also occur.

DAY/NIGHT

You can display pictures in color or black and white.

- When the SETUP menu screen is displayed, select 'DAY/NIGHT' by using the Up and Down buttons so that the arrow indicates 'DAY/NIGHT'.

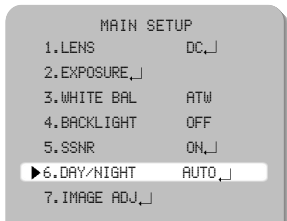

- Select a desired mode using the Left and Right buttons according to the picture display you want.

- COLOR**: The picture is always displayed in color.
- B/W**: The picture is always displayed in black and white.
- AUTO**: The mode is switched to 'Color' in a normal environment, but switches to 'B/W' mode when ambient illumination is low. To set up the switching time or speed for AUTO mode, press the SET button.



- EXTERN**: This mode allows you to apply a desired filter to external signals.

Notes

- When using a Video Auto Iris Lens, if you set the lens level to low, automatic switching between Color and Black & White may not occur.
- You cannot control the DAY/NIGHT menu when AGC in the EXPOSURE menu is 'OFF'.
At this time, the exchange between DAY mode and NIGHT mode operates as like selecting 'COLOR' mode.
- The OSD key does not work for 3 seconds when switching to Color or B/W, to ensure stable camera operation.
- The camera may focus less well under infrared illumination than under normal illumination.
- Since the camera may not focus as well under infrared illumination at night as it does under normal illumination, install an Extra-low Dispersion Lens to obtain sharp pictures.

How to Use the Camera

IMAGE ADJ.

1. When the SETUP menu screen is displayed, select 'IMAGE ADJ.' by using the Up and Down buttons so that the arrow indicates IMAGE ADJ.

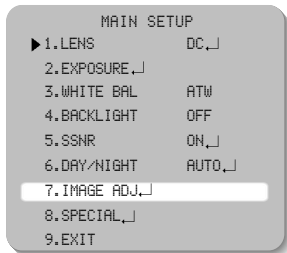

2. Select a desired mode using the Up and Down buttons.

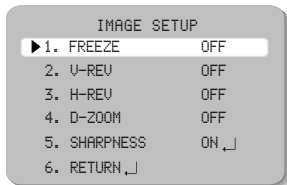

- FREEZE : You can view still or moving pictures.
- V-REV : You can flip the picture vertically on the screen.
- H-REV : You can flip the picture horizontally on the screen.

- D-ZOOM : You can use a digital zoom of x1~x10.



- SHARPNESS : As you increase this value, the picture outline becomes stronger and clearer. Adjust this value appropriately depending on the sharpness of the picture.



- RETURN : Select this to save the settings for the IMAGE ADJ. menu and to return to the SETUP menu.



Notes

- When H-REV or V-REV is selected, any text in the picture also will be flipped horizontally or vertically.
- If you increase the SHARPNESS level too high, the picture may become distorted or noise may appear.

How to Use the Camera

SPECIAL

1. When the SETUP menu screen is displayed, select 'SPECIAL' by using the Up and Down buttons so that the arrow indicates 'SPECIAL'.

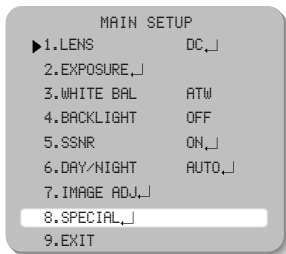

2. Select a desired mode using the Up and Down buttons.

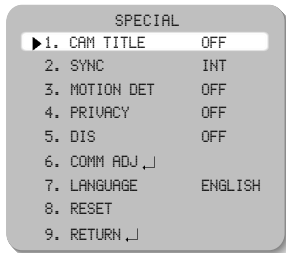

- ③ CAM TITLE : If you enter a title, the title will appear on the monitor.

- ① If the SPECIAL menu screen is displayed, use the Up and Down buttons so that the arrow indicates 'CAM TITLE'.

- ② Set it to 'ON' by using the Left and Right buttons.



Notes

- When the CAM TITLE menu is 'OFF', no title will be displayed on the monitor screen even if you enter one.

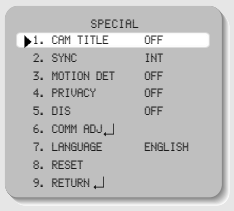

- ③ Press the SET button.

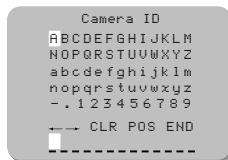

- ④ Use the 4 direction buttons to move to a desired letter and select the letter by pressing the SET button. Repeat this to enter multiple letters. You can enter up to 15 letters.



Notes

- If you move the cursor to CLR and press the SET button, all the letters are deleted. To edit a letter, change the cursor to the bottom left arrow and press the SET button. Move the cursor over the letter to be edited, move the cursor to the letter to be inserted and then press the SET button.

How to Use the Camera

- 5 Enter a title, move the cursor to 'POS' and press the SET button. The entered title appears on the screen. Select the position to display the title on the screen by using the 4 direction buttons and press the SET button. When the position is determined, select 'END' and press the SET button to return to the SPECIAL menu.

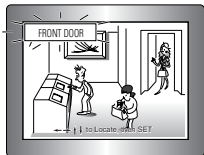

- 6 SYNC : In areas where the supply is at 60Hz, you can synchronize the output phase of multiple cameras using the power synchronization function (Line-Lock) without using a synchronization signal generator.

- INT : Internal Synchronization Type
- L/L : Power Synchronization Type, Line-lock

- Press the SET button.
- You can select a desired phase between 0 and 359.

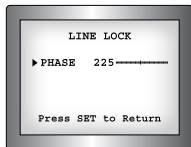

Notes

- When using AC power at 60Hz frequency, you can use the L/L type synchronization.
- When the power is DC 12V, the SYNC. menu is fixed to the 'INT' mode.

- 7 MOTION DET:

If you connect an alarm device to this camera, you can monitor activity more efficiently, because a signal is generated by the camera whenever motion is detected. The motion detection signal is output through the MD OUT port.

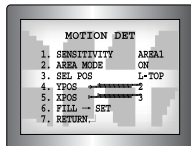

- 1 When the SPECIAL menu screen is displayed, press the Up and Down buttons so that the arrow indicates 'MOTION DET'.

- 2 Set up the mode using the 4 direction buttons.

- SENSITIVITY : You can select up to 8 MD areas. When SENSITIVITY number is high, motion detection sensitivity is increased to recognize even small movement.
- AREA MODE : Determines whether to use the MD area selected in SENSITIVITY.
- SEL POS : Determines which of the 4 vertices of each MD area is to be used.
- YPOS : Determines the coordinate of the vertical axis for SEL POS.
- XPOS : Determines the coordinate of the horizontal axis for SEL POS.
- FILL →SET : Fills in a selected MD area. Fills in a selected MD area. The color of filling is sequentially selected as brown, orange, blue, cyan, yellowish green, yellow and red.
- RETURN : Select this to save the MOTION DET menu settings and return to the SPECIAL menu.



Notes

- MD areas show only MOTION DET menu. Therefore, MD areas don't display on the monitor screen.

- 8 PRIVACY : Hide an area you want to hide on the screen.

- 1 When the SPECIAL menu screen is displayed, press the Up and Down buttons so that the arrow indicates 'PRIVACY'.



- 2 Set up the mode using the 4 direction buttons.

- AREA SEL : You can select up to 8 MD areas.
- AREA MODE : Determines whether to use the area selected in the AREA SEL, and the size and position of the area.

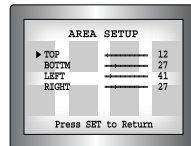

- MASK COLOR : Determine area color. You can select Gray, Green, Red, Blue, Black, White.
- TRANSP : Determine the transparency of selected area as controlling number from 0 to 3.
- RETURN : Select this to save the PRIVACY menu settings and return to the SPECIAL menu.

DIS (Digital Image Stabilizer) :

This function mitigates any picture movement due to external factors such as wind.

COMM ADJ (Communication Adjustment) :

This function sets up the camera communication status when controlling the camera through an external control device.

① When the SPECIAL menu screen is displayed, press the Up and Down buttons so that the arrow indicates 'COMM ADJ'.

② Set up the mode using the 4 direction buttons.

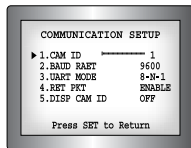

- CAM ID : Determines the camera's identification number (between 0 and 25).
- BAUD RATE : You can select 2400/4800/9600/19200/38400/57600 bps.
- UART MODE : You can select NONE, EVEN or ODD for the parity bits.
- RET PKT : Determines whether to send a command back to the controller device when a communication control command is sent to the camera.
- DISP CAM ID : Display camera title on top left corner of the screen.

LANGUAGE : You can select the menu language according to your requirements.

RESET : Resets the camera settings to the factory defaults.

RETURN : Select this to save the SPECIAL menu settings and return to the SPECIAL menu.

EXIT

Press the SET button in the EXIT menu to save the current settings and exit the SET menu.

If you have trouble operating your camera, refer to the following table.

If the guidelines do not enable you to solve the problem, contact an authorized technician.

Problem	Solution
Nothing appears on the screen.	<ul style="list-style-type: none"> • Check that the power cord and line connection between the camera and monitor are fixed properly. • Check that you have properly connected VIDEO cable to the camera VIDEO output jack.
The image on the screen is dim.	<ul style="list-style-type: none"> • Is lens stained with dirt? Clean your lens with soft, clean cloth. • Set the monitor to proper condition. • If the camera is exposed to too strong light, change the camera position.
The image on the screen is dark.	<ul style="list-style-type: none"> • Adjust the contrast feature of the monitor. • If you have an intermediate device, set the 75Ω / Hi-z properly.
The camera is not working properly, and the surface of the camera is hot.	<ul style="list-style-type: none"> • Check that you have properly connected the camera to an appropriate power source.
The DAY/NIGHT menu does not work.	<ul style="list-style-type: none"> • Check that AGC of EXPOSURE SETUP menu is 'OFF'.
The SENS-UP function does not work.	<ul style="list-style-type: none"> • Check that AGC of EXPOSURE SETUP menu is 'OFF'. • Check that SHUTTER of EXPOSURE SETUP menu is 'A.FLK' or 'MANUAL'.

Problem	Solution																
The Motion Detection function does not work.	<ul style="list-style-type: none"> Check that MOTION DEF of SPECIAL SETUP menu is 'OFF'. 																
Color is not correct.	<ul style="list-style-type: none"> Check the setting of WHITE BAL SETUP menu . 																
The screen flickers continually.	<ul style="list-style-type: none"> Check that direction of camera turns toward the Sun. 																
RS-485 communication fails.	<ul style="list-style-type: none"> Check the polarity between RS-485 Control Port and RS-485 cable. <table border="1" data-bbox="307 481 628 533"> <thead> <tr> <th>485 Control Board Connection Port</th> <th>RS-485 Control Port</th> </tr> </thead> <tbody> <tr> <td>(+) CONNECTION TERMINAL (TRX+)</td> <td>485+</td> </tr> <tr> <td>(-) CONNECTION TERMINAL (TRX-)</td> <td>485-</td> </tr> </tbody> </table> <ul style="list-style-type: none"> Check the RS-485 Communication establishment initial value <p>* RS-485 Communication establishment initial value</p> <table border="1" data-bbox="307 616 628 657"> <thead> <tr> <th>Item</th> <th>Camera ID</th> <th>BAUD RATE</th> <th>UART MODE</th> <th>PET PKT</th> </tr> </thead> <tbody> <tr> <td>Initial value</td> <td>1</td> <td>9600</td> <td>8-NONE-1</td> <td>ENABLE</td> </tr> </tbody> </table>	485 Control Board Connection Port	RS-485 Control Port	(+) CONNECTION TERMINAL (TRX+)	485+	(-) CONNECTION TERMINAL (TRX-)	485-	Item	Camera ID	BAUD RATE	UART MODE	PET PKT	Initial value	1	9600	8-NONE-1	ENABLE
485 Control Board Connection Port	RS-485 Control Port																
(+) CONNECTION TERMINAL (TRX+)	485+																
(-) CONNECTION TERMINAL (TRX-)	485-																
Item	Camera ID	BAUD RATE	UART MODE	PET PKT													
Initial value	1	9600	8-NONE-1	ENABLE													

	SHC-735N	SHC-735P		
POWER	Input Voltage	AC24V / DC12V		
	Power Consumption	4.0W		
CCD	Size	Diagonal 6mm (1/3") Sony DS CCD		
	Total Pixels	811(H) x 508(V)	795(H) x 596(V)	
	Effective Pixels	768(H) x 494(V)	752(H) x 582(V)	
Sync	Scanning System	2-1 Interlace		
	Synchronization	Internal / Line Lock		
	Frequency	Horizontal : 15.734 KHz, Vertical:59.94 Hz	Horizontal : 15.625 KHz, Vertical:50.00 Hz	
O.S.D	Korean, English, Japanese, Spanish	English, French, Germany, Spanish, Italy, Chinese		
E L E C T R I C A L	WDR	52 dB		
	Back-light Comp.	ON/OFF		
	Resolution	Color : 560 TV Lines † BW : 700 TV Lines †		
	S/N (Y signal)	52 dB (AGC Off, Weight ON)		
	Min. Illumination	0.001 Lux (Color Sens-up), 0.00004 Lux (B/W Sens-up) at F1.2		
	White Balance	ATW / AWC / Manual / Outdoor / Indoor (1800K ~ 10,500K)		
	Electronic Shutter Speed	1/60 ~ 1/120,000 sec	1/50 ~ 1/120,000 sec	
	Sens-up	AUTO / OFF (Selectable x2 ~ x256)		
	Gain Control	LOW / HIGH / OFF		
	SSNR	ON / OFF (1~32 Level)		
	Motion Detection	ON / OFF (8 Zone, ALARM Output)		
	PRIVACY	ON/OFF (8 Zone)		
	V-REV	ON / OFF		
	H-REV	ON / OFF		
	FREEZE	ON / OFF		
	SHARPNESS	ON/OFF (Level Adjustable)		
	IRIS Control	DC / Video		
	Day & Night	COLOR / Black& White/AUTO/EXT		
	DIS	ON / OFF		
	Digital Zoom	ON / OFF (x10)		
	Blemish Compensation	256 point (Even 128 Point, Odd 128 Point)		
	Communication	RS-485 (2400, 4800, 9600, 19200, 38400, 57600 bps selectable) (STW Protocol, Pelco-D Protocol available)		
	Lens Mount	CS Mount (Easy Focus type) (C Mount is mountable by using adaptor)		
	Back Focus Adjustment	Manual		
	Operating temperature / Humidity	-10°C to +50°C / 30% to 80% RH		
	Storing Temperature / Humidity	-20°C to +60°C / 20% to 90% RH		
Dimension	65.8(W) x 60.6(H) x 101.9(D)mm			
Weight	315g			

DECLARATION OF CONFORMITY

MEMO

Application of Council Directive(s)	89 / 336 / EEC
Manufacturer's Name	SAMSUNG TECHWIN CO., LTD
Manufacturer's Address	SAMSUNG TECHWIN CO., LTD 42, SUNGJU-DONG CHANGWON-CITY, KYUNGNAM, KOREA, 641-716
European Representative Name	
European Representative Address	
Equipment Type/Environment	CCTV Camera
Model Name	SHC-735
Beginning Serial NO.	S7090001
Year of Manufacture	2007.09.01
Conformance to	EN 50081-1 : 1992 EMC-Directive 89/336 EEC and 92/31/EEC EN 50130-4 : 1996

We, the undersigned, hereby declare that the equipment specified above conforms to the above Directive(s).

Manufacturer	SAMSUNG TECHWIN CO., LTD	Legal Representative in Europe
Signature	<i>Young Taek, SON</i>	Signature
Full Name	YOUNG TAEK SON	Full Name
Position	QUALITY CONTROL MANAGER	Position
Place	CHANGWON, KOREA	Place
Date	2007. 09. 01	Date

MEMO

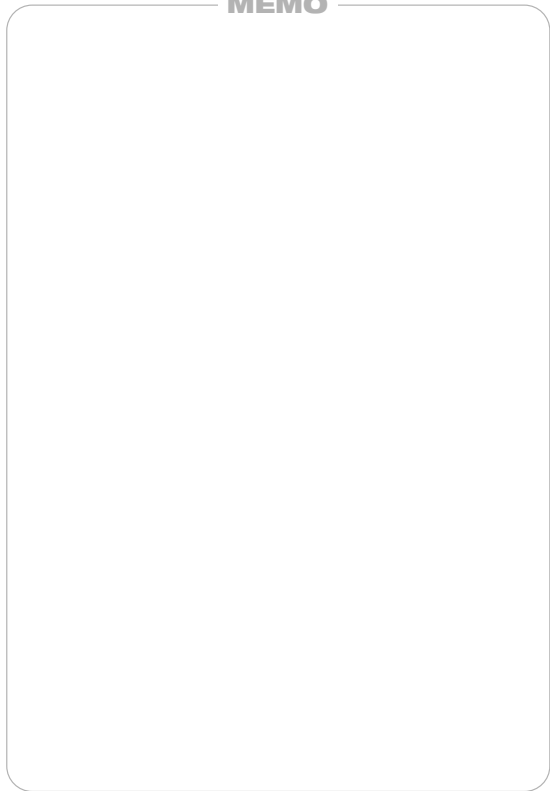
A large, empty rectangular box with rounded corners, intended for writing a memo. The box is defined by a thin black border and occupies most of the left side of the page.