

# 19 inch HN Series TFT LCD Monitor

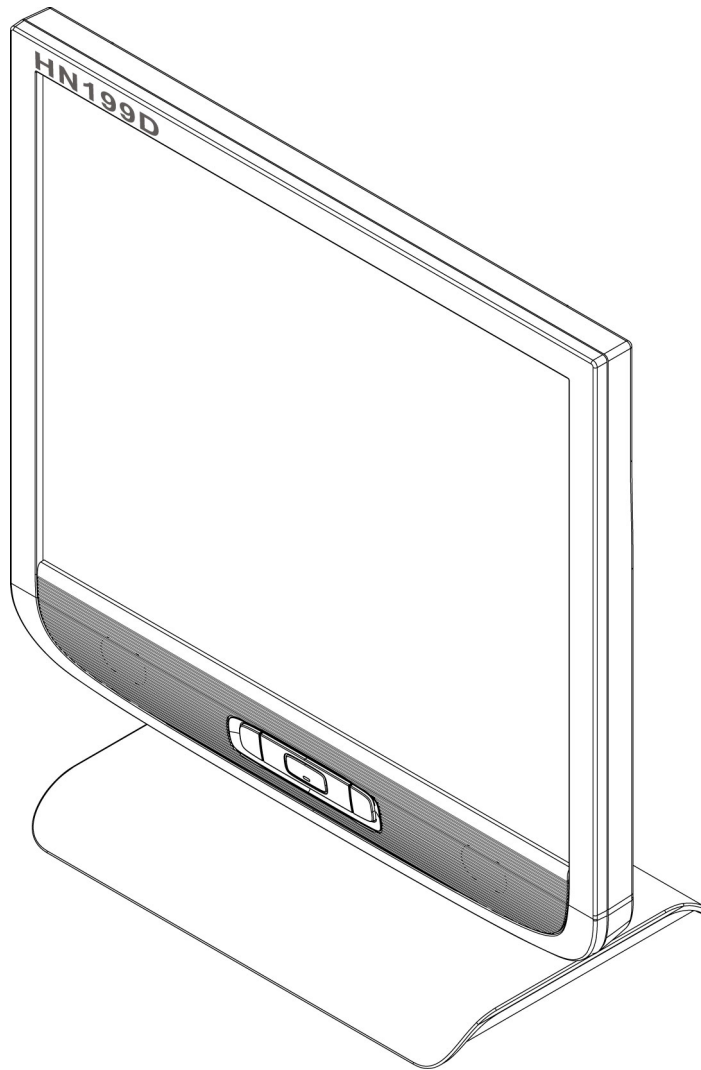

**HANN S·G**

**USER'S MANUAL**

Before operating the monitor, please read this manual thoroughly. This manual should be retained for future reference.

## **FCC Class B Radio Frequency Interference Statement**

This equipment has been tested and found to comply with the limits for a Class B digital device, pursuant to Part 15 of the FCC Rules. These limits are designed to provide reasonable protection against harmful interference in a residential installation. This equipment generates, uses and can radiate radio frequency energy, and if not installed and used in accordance with the instructions, may cause harmful interference to radio communications. However, there is no guarantee that interference will not occur in a particular installation. If this equipment does cause harmful interference to radio or television reception, which can be determined by turning the equipment off and on, the user is encouraged to try to correct the interference by one or more of the following measures:

- Reorient or relocate the receiving antenna.
- Increase the separation between the equipment and receiver.
- Connect the equipment into an outlet on a circuit different from that to which the receiver is connected.
- Consult the dealer or an experienced radio/TV technician for help.

The device complies with Parts 15 of the FCC Rule. Operation is subject to the following two conditions: (1) this device may not cause harmful interference; and (2) this device must accept any interference received, including interference that may cause undesired operations.

### **CANADA**

This Class B digital apparatus meets all requirements of the Canadian Interference-Causing Equipment Regulation.



This device complies with requirement of EMC directive 89/336/EEC with regard to Electromagnetic Compatibility, and 73/23/EEC and 93/68/EEC with regard to Low Voltage directive.

Socket-outlet shall be near the equipment and shall be accessible.



### **Congratulations!**

The display you have just purchased carries the TCO'03 Displays label. This means that your display is designed, manufactured and tested according to some of the strictest quality and environmental requirements in the world. This makes for a high performance product, designed with the user in focus that also minimizes the impact on our natural environment.

Some of the features of the TCO'03 Display requirements:

#### **Ergonomics**

- Good visual ergonomics and image quality in order to improve the working environment for the user and to reduce sight and strain problems. Important parameters are luminance, contrast, resolution, reflectance, colour rendition and image stability.

#### **Energy**

- Energy-saving mode after a certain time – beneficial both for the user and the environment
- Electrical safety

#### **Emissions**

- Electromagnetic fields
- Noise emissions

#### **Ecology**

- The product must be prepared for recycling and the manufacturer must have a certified environmental management system such as EMAS or ISO 14 001
- Restrictions on
  - chlorinated and brominated flame retardants and polymers
  - heavy metals such as cadmium, mercury and lead.

The requirements included in this label have been developed by TCO Development in cooperation with scientists, experts, users as well as manufacturers all over the world. Since the end of the 1980s TCO has been involved in influencing the development of IT equipment in a more user-friendly direction. Our labelling system started with displays in 1992 and is now requested by users and IT-manufacturers all over the world.

For more information, please visit  
[www.tcodevelopment.com](http://www.tcodevelopment.com)

## Recycling Information

We, the **HannStar Display Corp.** care very much about our environment protection strategy and firmly believe that it helps us have healthier earth via appropriate treatment and recycling of industrial technology devices at the end-of-life. These devices contain recyclable materials, which can be re-decomposed and re-integrated into brand-new marvels. On the contrary, other material can be classified to hazardous and poisoned substances. We strongly encourage you to contact the provided information to recycle this product.

**United State :** <http://newyork.earth911.org/>

**Asia :** [http://recycle.epa.gov.tw/public/public4\\_2.htm](http://recycle.epa.gov.tw/public/public4_2.htm)

**Europe :**

**Ireland**

**Company : McGrath Environmental Consultants Ltd.**

**Contact Person : Ms. McGrath Clodagh**

Address: 20 Lower John Street, Cork, Ireland.

Tel : 021 4554833 Fax : 021 4505805

**Norway :**

**Company : Bergfald & Co as Contact Person : Mr. Solevåg Øystein**

Address : Solavågsvegen 90, EIDSNES, NORWAY ,Post Code : N-6037

Tel : +47 40 23 47 05 Fax : +47 70 19 40 17

Web Site : [http://www.bergfald.no/bergfald\\_english.html](http://www.bergfald.no/bergfald_english.html)

**United Kingdom :**

**Company : ARENA Network Contact Person : Dr. Tillotson Allen**

Address : Bank Buildings Treforest Estate, Pontypridd, Rhondda Cynon Taff, Kindom Post Code :

CF37 5UR

Tel : 01443 844001 Fax : 01443 844002

Web Site : <http://www.arenanetwork.org>

## TABLE OF CONTENTS

<b>SAFETY NOTICE .....</b>	<b>6</b>
<b>PRECAUTIONS .....</b>	<b>6</b>
<b>SPECIAL NOTES ON LCD MONITORS .....</b>	<b>7</b>
<b>BEFORE YOU OPERATE THE MONITOR.....</b>	<b>8</b>
<b>FEATURES .....</b>	<b>8</b>
<b>CHECKING THE CONTENTS OF THE PACKAGE .....</b>	<b>8</b>
<b>INSTALLATION INSTRUCTIONS .....</b>	<b>9</b>
<b>POWER.....</b>	<b>10</b>
<b>CONTROLS AND CONNECTORS.....</b>	<b>11</b>
<b>ADJUSTING THE VIEWING ANGLE .....</b>	<b>12</b>
<b>OPERATING INSTRUCTIONS.....</b>	<b>13</b>
<b>GENERAL INSTRUCTIONS.....</b>	<b>13</b>
<b>FRONT PANEL CONTROL .....</b>	<b>14</b>
<b>HOW TO ADJUST A SETTING .....</b>	<b>15</b>
<b>PLUG AND PLAY .....</b>	<b>16</b>
<b>TECHNICAL SUPPORT (FAQ).....</b>	<b>18</b>
<b>Q &amp; A FOR GENERAL DEFECTIVE .....</b>	<b>18</b>
<b>ERROR MESSAGE &amp; POSSIBLE SOLUTION.....</b>	<b>19</b>
<b>APPENDIX .....</b>	<b>20</b>
<b>SPECIFICATIONS .....</b>	<b>20</b>
<b>CONNECTOR PIN ASSIGNMENT .....</b>	<b>21</b>

## **SAFETY NOTICE**

1. The changes or modifications not expressly approved by the party responsible for compliance could void the user's authority to operate the equipment.
2. Shielded interface cables and AC power cord, if any, must be used in order to comply with the emission limits.
3. The manufacturer is not responsible for any radio or TV interference caused by unauthorized modification to this equipment. It is the responsibilities of the user to correct such interference.

### **WARNING:**

To prevent fire or shock hazard, do not expose the monitor to rain or moisture. Dangerously high voltages are present inside the monitor. Do not open the cabinet. Refer servicing to qualified personnel only.

## **PRECAUTIONS**

- Do not use the monitor near water, e.g. near a bathtub, washbowl, kitchen sink, laundry tub, swimming pool or in a wet basement.
- Do not place the monitor on an unstable cart, stand, or table. If the monitor falls, it can injure a person and cause serious damage to the appliance. Use only a cart or stand recommended by the manufacturer or sold with the monitor. If you mount the monitor on a wall or shelf, use a mounting kit approved by the manufacturer and follow the kit instructions.
- Slots and openings in the back and bottom of the cabinet are provided for ventilation. To ensure reliable operation of the monitor and to protect it from overheating, be sure these openings are not blocked or covered. Do not place the monitor on a bed, sofa, rug, or similar surface. Do not place the monitor near or over a radiator or heat register. Do not place the monitor in a bookcase or cabinet unless proper ventilation is provided.
- The monitor should be operated only from the type of power source indicated on the label. If you are not sure of the type of power supplied to your home, consult your dealer or local power company.
- Unplug the unit during a lightening storm or when it will not be used for long period of time. This will protect the monitor from damage due to power surges.
- Do not overload power strips and extension cords. Overloading can result in fire or electric shock.
- Never push any object into the slot on the monitor cabinet. It could short circuit parts causing a fire or electric shock. Never spill liquids on the monitor.
- Do not attempt to service the monitor by yourself; opening or removing covers can expose you to dangerous voltages and other hazards. Please refer all servicing to qualified service personnel.
- To ensure satisfactory operation, use the monitor only with UL listed computers which have appropriate configured receptacles marked between 100 - 240V AC, Min. 5A.
- The wall socket shall be installed near the equipment and shall be easily accessible.

## **SPECIAL NOTES ON LCD MONITORS**

The following symptoms are normal with LCD monitor and do not indicate a problem.

- Due to the nature of the fluorescent light, the screen may flicker during initial use. Turn off the Power Switch and then turn it on again to make sure the flicker disappears.
- You may find slightly uneven brightness on the screen depending on the desktop pattern you use.
- The LCD screen has effective pixels of 99.99% or more. It may include blemishes of 0.01% or less such as a missing pixel or a pixel lit all of the time.
- Due to the nature of the LCD screen, an afterimage of the previous screen may remain after switching the image, when the same image is displayed for hours. In this case, the screen is recovered slowly by changing the image or turning off the Power Switch for hours.
- If the screen suddenly flashes erratically or the backlighting fails, please contact your dealer or service center for repair. Do not attempt to repair the monitor yourself.

# BEFORE YOU OPERATE THE MONITOR

## FEATURES

- 19" TFT Color LCD Monitor
- Crisp, Clear Display for Windows
- Recommended Resolutions: 1280 X 1024 @60Hz
- EPA ENERGY STAR®
- Ergonomic Design
- Space Saving, Compact Case Design

## CHECKING THE CONTENTS OF THE PACKAGE

The product package should include the following items:

**LCD Monitor**  
(Reference only, the real feature is depended on selected model)

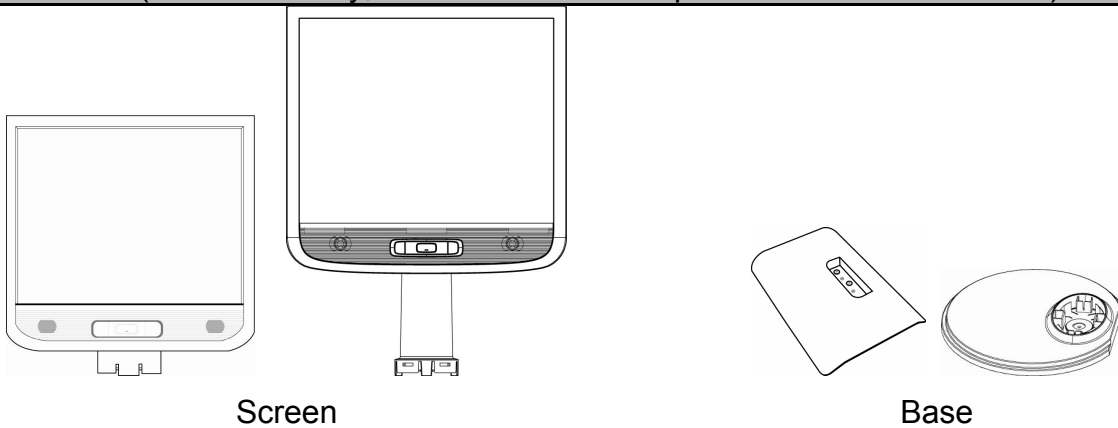

**Cables and User manual**

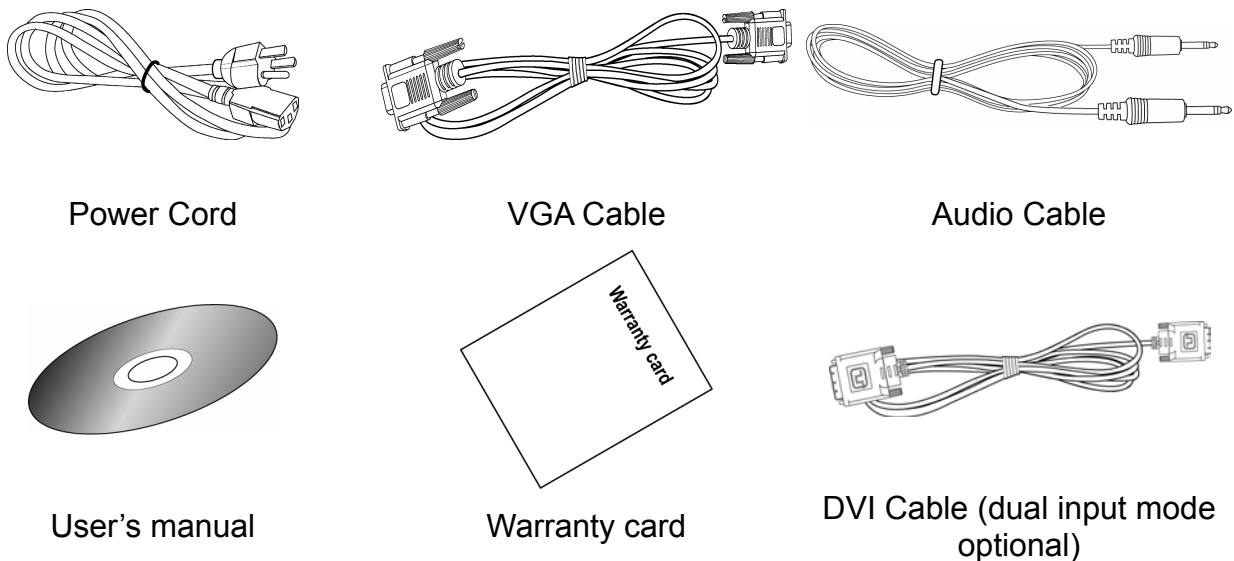



## INSTALLATION INSTRUCTIONS

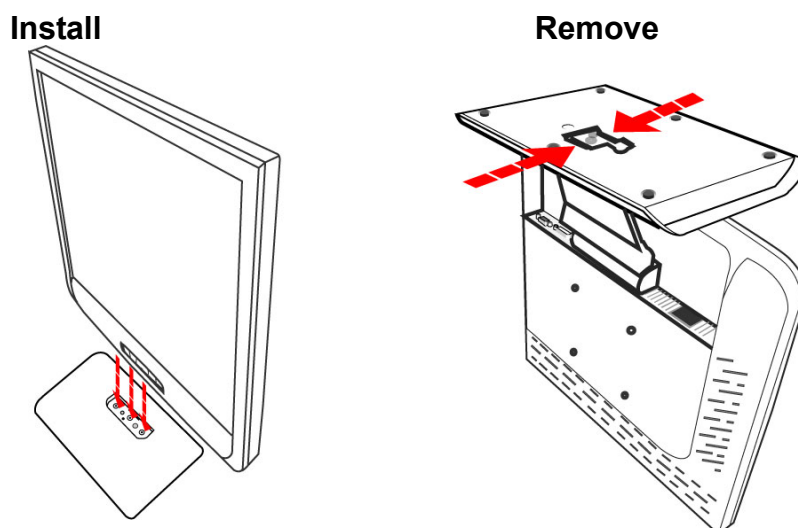

Figure.1. Installing and Removing the Base

### **INSTALLATION:**

1. Align the monitor with the opening in the base.
2. Note that the longer section of the base points forward.
3. Snap the monitor into its base. A clear click sound will affirm that the base is connected correctly.
4. Verify that the monitor is securely attached to the base by looking at the bottom of the base and making sure that the clips are fully engaged in the base.

### **REMOVAL:**

1. Flip over the monitor so that it is upside down.
2. Press the 2 clips that hold the monitor in place.
3. Gently press and hold the 2 clips while pulling the base from the monitor unit they are unattached.

### **ADJUSTING THE STAND (Optional)**

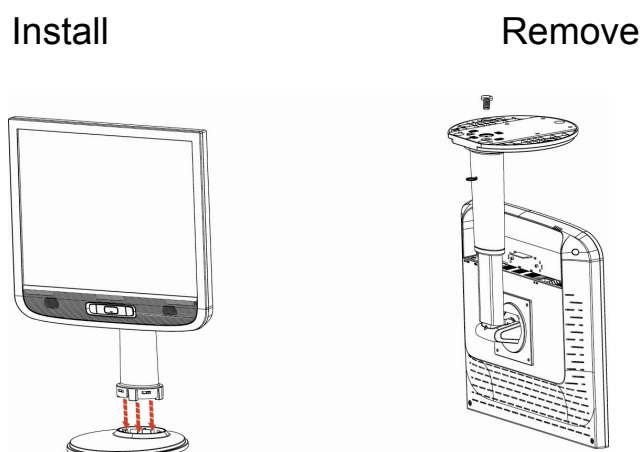

To set up the device, you need to assemble the monitor stand.

Join the stand base to the stand post. You should be able to hear it slot in. Insert the screw enclosed, tightening it with a coin or a screwdriver, so that the stand base is attached securely to the stand post. To set up the device, you must fit the monitor base together. You can adjust the height of the base. When the base of the monitor is extended, you can tilt the monitor 90° (Pivot function).

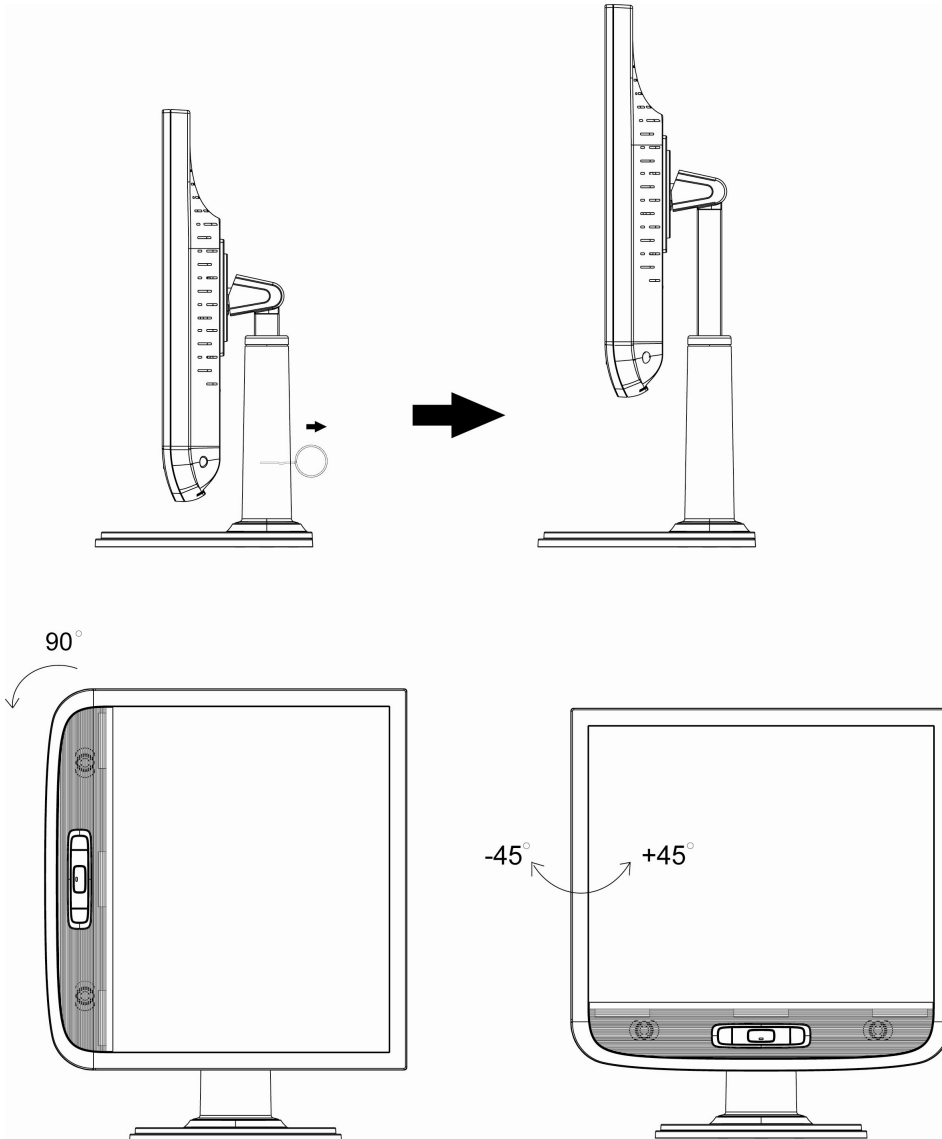

## **POWER**

### **POWER SOURCE:**

1. Make sure that the power cord is the correct type required in your area.
2. This LCD monitor has an Internal universal power supply that allows operation in either 100/120V AC or 220/240V AC voltage area (No user adjustment is required.)
3. Connect the AC-power cord one end to your LCD monitor's AC-input socket, the other end to wall-outlet .

## CONTROLS AND CONNECTORS

### **CABLE CONNECTIONS:**

Turn off your computer before performing the procedure below.

1. Connect one end of the 15-pin D-Sub cable to the back of the monitor and connect the other end to the computer's D-Sub port.
2. Connect one end of the 24-pin DVI cable (Dual input mode optional) to the back of the monitor and connect the other end to the computer's DVI port.
3. Connect the audio cable between the monitor's audio input and the PC's audio output (green port).
4. Plug the AC-power cord one end to LCD monitor's AC input socket, the other end to Wall outlet.
5. Turn on your monitor and computer.

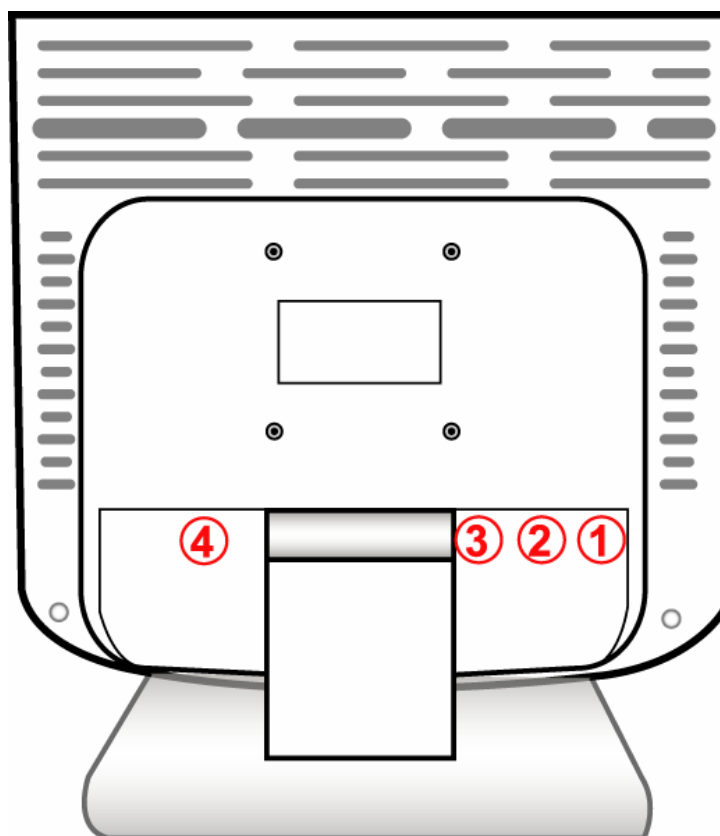

Figure.2. Connecting Cables

1.	VGA Input	2.	DVI Input (optional)
3.	Audio Input	4.	Power AC Input

## ADJUSTING THE VIEWING ANGLE

- For optimal viewing it is recommended to look at the full face of the monitor, then adjust the monitor's angle to your own preference.
- Hold the stand so you do not topple the monitor when you change the monitor's angle.
- You are able to adjust the monitor's angle from 0° to 20°.

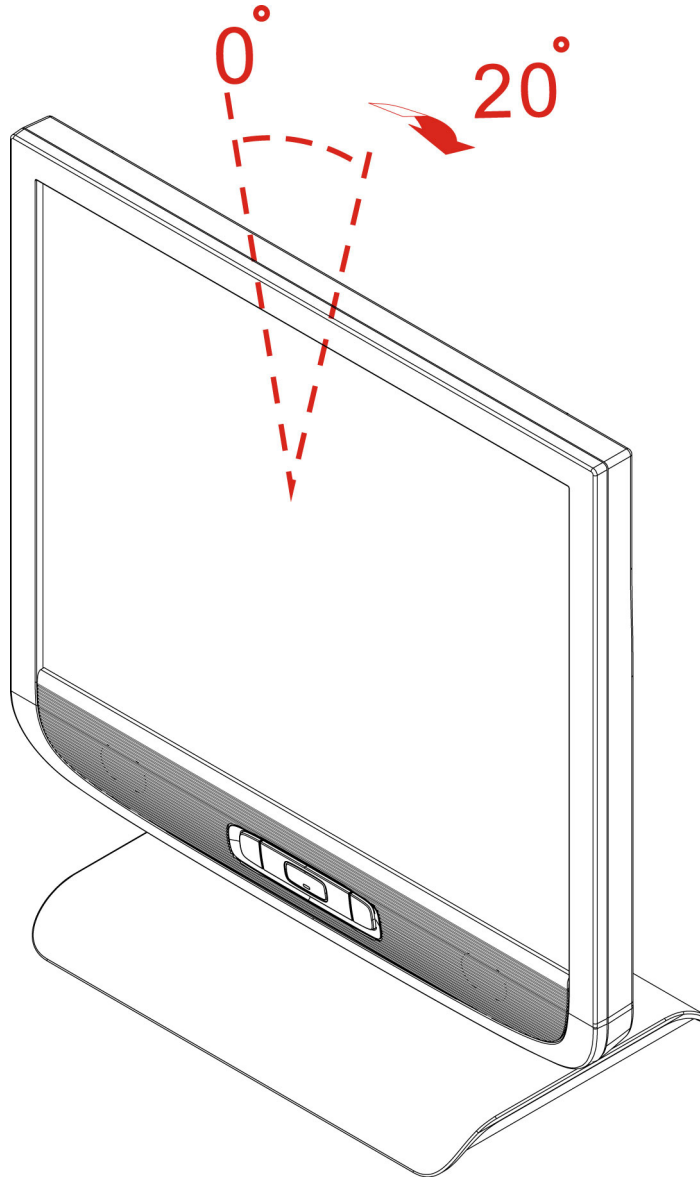

Figure.3. monitor's angle

### **NOTES:**

- Do not touch the LCD screen when you change the angle. It may cause damage or break the LCD screen.
- Be careful not to place fingers or hands near the hinges when tilting the monitor, otherwise pinching can result.

# OPERATING INSTRUCTIONS

## GENERAL INSTRUCTIONS

Press the power button to turn the monitor on or off. The other control buttons are located at front panel of the monitor (See Figure 4). By changing these settings, the picture can be adjusted to your personal preferences.

- The power cord should be connected.
- Connect the Signal cable from the monitor to the VGA card.
- Press the power button to turn on the monitor position. The power indicator will light up.

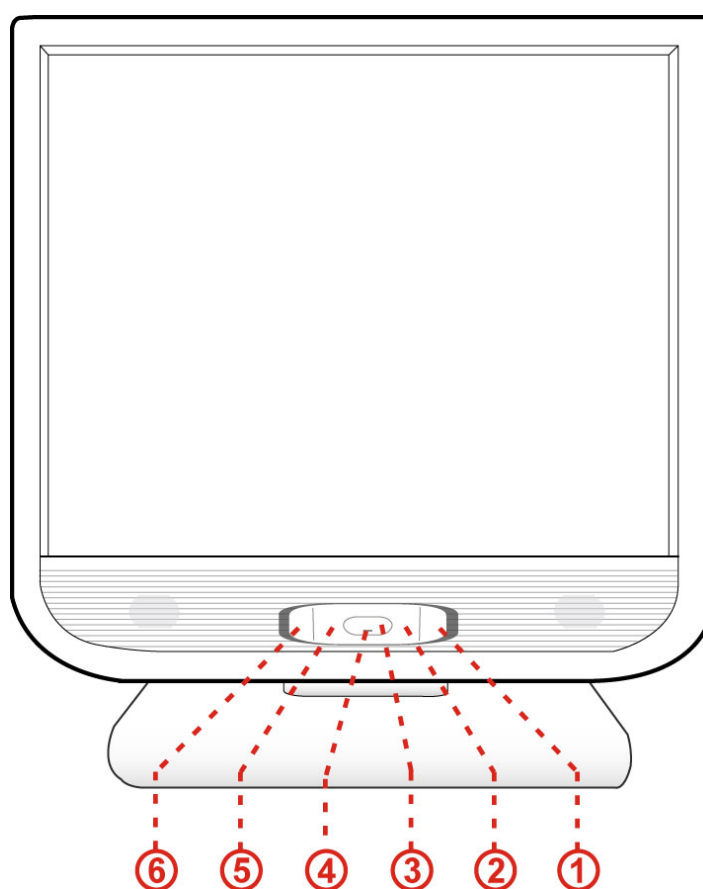

Figure.4. External Control Button

### EXTERNAL CONTROLS:

1.	Menu / Enter	2.	Volume >
3.	Power Button	4.	Power Indicator
5.	Volume <	6.	Auto Adjustment



## FRONT PANEL CONTROL



- **Power Button:**  
Press this button to switch ON/OFF of monitor's power.
- **Power Indicator:**  
Green — Power On mode.  
Orange — Off mode.
- **MENU / ENTER:**
  1. Active OSD menu or function adjust confirm or
  2. Exit OSD menu when in volume OSD status.
- **Volume < >:**
  1. Activates the volume control when the OSD is OFF.
  2. Navigate through adjustment icons when OSD is ON or adjust a function when function is activated.
- **Auto Adjust button:**  
When OSD menu is in off status, press this button to activate the Auto Adjustment function.  
(The Auto Adjustment function is used to optimized the H-Position, V-Position, Clock and Focus.)

### **NOTES:**

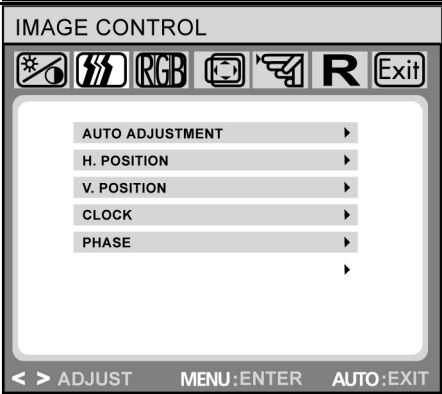
- Do not install the monitor in a location near heat sources such as radiators or air ducts, or in a place subject to direct sunlight, or excessive dust or mechanical vibration or shock.
- Save the original shipping box and packing materials, as they will come in handy if you ever have to ship your monitor.
- For maximum protection, repackage your monitor as it was originally packed at the factory.
- To keep the monitor looking new, periodically clean it with a soft cloth. Stubborn stains may be removed with a cloth lightly dampened with a mild detergent solution. Never use strong solvents such as thinner, benzene, or abrasive cleaners, since these will damage the cabinet. As a safety precaution, always unplug the monitor before cleaning it.

## HOW TO ADJUST A SETTING

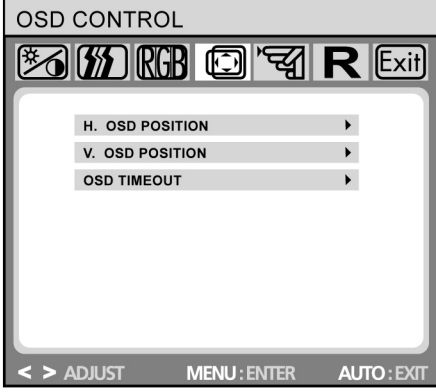
OSD Diagram	OSD Description
 <p>The diagram shows the 'BRIGHTNESS CONTRAST' OSD menu. At the top, it has a title bar with icons for brightness, contrast, RGB, image, and a red 'R' button, followed by an 'Exit' button. Below the title bar, there are two menu items: 'BRIGHTNESS' and 'CONTRAST', each with a right-pointing arrow. At the bottom, there are three control buttons: '&lt; &gt; ADJUST', 'MENU:ENTER', and 'AUTO:EXIT'.</p>	<p><b>Brightness/Contrast adjustment:</b></p> <p><b>Brightness:</b> Adjusts brightness by using the buttons &lt; or &gt; (② and ⑤ in fig. 4).</p> <p><b>Contrast:</b> Adjusts screen contrast by using the buttons &lt; or &gt; (② and ⑤ in fig. 4).</p>
 <p>The diagram shows the 'IMAGE CONTROL' OSD menu. At the top, it has a title bar with icons for brightness, contrast, RGB, image, and a red 'R' button, followed by an 'Exit' button. Below the title bar, there are five menu items: 'AUTO ADJUSTMENT', 'H. POSITION', 'V. POSITION', 'CLOCK', and 'PHASE', each with a right-pointing arrow. At the bottom, there are three control buttons: '&lt; &gt; ADJUST', 'MENU:ENTER', and 'AUTO:EXIT'.</p>	<p><b>Image Control:</b></p> <p><b>Auto Adjustment:</b> Automatically selects the optimal settings for image parameters (image position, phase, etc.) by using the button <b>MENU</b> (① in fig. 4).</p> <p><b>H. Position:</b> Controls the picture's horizontal position.</p> <p><b>V. Position:</b> Controls the picture's vertical position.</p> <p><b>Clock:</b> Sets up the internal clock. Larger values make the displayed image appear wider; smaller values make it appear compressed.</p> <p><b>Phase:</b> Adjusts the internal clock's time lag in order to optimize the screen image.</p>
 <p>The diagram shows the 'COLOR' OSD menu. At the top, it has a title bar with icons for brightness, contrast, RGB, image, and a red 'R' button, followed by an 'Exit' button. Below the title bar, there are three menu items: '9300K', '6500K', and 'CUSTOM COLOR', each with a right-pointing arrow. At the bottom, there are three control buttons: '&lt; &gt; ADJUST', 'MENU:ENTER', and 'AUTO:EXIT'.</p>	<p><b>Color:</b></p> <p>This menu lets you select a preset color temperature (9300K, 6500K) by pressing the OSD buttons &lt; or &gt; (② and ⑤ in fig. 4). Changes to the color temperature take immediate effect on screen. If you wish to set individual color values, select the <b>Custom Color</b> option. Then press the <b>MENU</b> button (① in fig. 4) to select the red, green and blue settings and set the desired value using the OSD buttons &lt; or &gt; (② and ⑤ in fig. 4). The current settings are automatically saved when you return to the previous level or exit the OSD menu.</p>

OSD Diagram	OSD Description
 <p>The OSD CONTROL menu is displayed within a rectangular frame. At the top, it is titled 'OSD CONTROL'. Below the title is a row of icons: a star, a lightning bolt, 'RGB', a monitor icon, a speaker icon, 'R', and 'Exit'. The main area contains three menu items: 'H. OSD POSITION', 'V. OSD POSITION', and 'OSD TIMEOUT', each with a right-pointing arrow. At the bottom, there is a navigation bar with '&lt; &gt; ADJUST', 'MENU: ENTER', and 'AUTO: EXIT'.</p>	<p><b>OSD Control:</b></p> <p><b>H. OSD Position:</b> Controls the OSD menu's horizontal position.</p> <p><b>V. OSD Position:</b> Controls the OSD menu's vertical position.</p> <p><b>OSD Timeout:</b> Determines how long (in seconds) the OSD menu waits before closing automatically after no action has been performed.</p>
 <p>The OTHER menu is displayed within a rectangular frame. At the top, it is titled 'OTHER'. Below the title is a row of icons: a star, a lightning bolt, 'RGB', a monitor icon, a speaker icon, 'R', and 'Exit'. The main area contains four menu items: 'LANGUAGE', 'INPUT', 'SPEAKER VOLUME', and 'INFORMATION', each with a right-pointing arrow. At the bottom, there is a navigation bar with '&lt; &gt; ADJUST', 'MENU: ENTER', and 'AUTO: EXIT'.</p>	<p><b>Other:</b></p> <p>English. French. German. Italian. Spanish. Japanese. Portuguese. Netherlands. Korea. Simplify Chinese. Traditional Chinese.</p> <p><b>Input:</b> Controls the selection of the input signal. The monitor allows you to make the following connections: analog graphics card via the 15-pin mini D-Sub interface, digital graphics card via the 24-pin DVI-D interface.</p> <p><b>Speaker Volume:</b> Adjusts the monitor loudspeaker output volume.</p> <p><b>Information:</b> There is an optional OSD window (on/off) that displays the newly adjusted screen resolution settings.</p>

## PLUG AND PLAY

### Plug & Play DDC2B Feature

This monitor is equipped with VESA DDC2B capabilities according to the VESA DDC STANDARD. It allows the monitor to inform the host system of its identity and, depending on the level of DDC used, communicate additional information about its display capabilities. The DDC2B is a bidirectional data channel based on the I<sup>2</sup>C protocol. The host can request EDID information over the DDC2B channel.

**THIS MONITOR WILL APPEAR TO BE NON-FUNCTIONAL IF THERE IS NO VIDEO INPUT SIGNAL. IN ORDER FOR THIS MONITOR TO OPERATE PROPERLY, THERE MUST BE A VIDEO INPUT SIGNAL.**

This monitor meets the Green monitor standards as set by the Video Electronics Standards Association (VESA) and/or the United States Environmental Protection Agency (EPA) and The Swedish Confederation Employees (NUTEK). This feature is designed to conserve



electrical energy by reducing power consumption when there is no video-input signal present. When there is no video input signal this monitor, following a time-out period, will automatically switch to an OFF mode. This reduces the monitor's internal power supply consumption. After the video input signal is restored, full power is restored and the display is automatically redrawn. The appearance is similar to a "Screen Saver" feature except the display is completely off. The display is restored by pressing a key on the keyboard, or clicking the mouse.

## TECHNICAL SUPPORT (FAQ)

### Q & A FOR GENERAL DEFECTIVE

PROBLEM & QUESTION	POSSIBLE SOLUTION
Power LED is not on	*Check if the Power Switch is in the ON position *Power Cord should be connected
No Plug & Play	*Check if the PC system is Plug & Play compatible *Check if the Video Card is Plug & Play compatible *Check if the D-15 plug pin of Video Cable is bent
Picture is fuzzy	*Adjust the Contrast and Brightness Controls.
Picture bounces or a wave pattern is present in the picture	*Move electrical devices that may cause electrical interference.
The power LED is ON (orange) but there's no video or no picture.	*Computer Power Switch should be in the ON position. *Computer Video Card should be snugly seated in its slot *Make sure monitor's video cable is properly connected to the computer. *Inspect monitor's video cable and make sure none of the pins are bent. *Make sure computer is operational by hitting the CAPS LOCK key on the keyboard while observing the CAPS LOCK LED. The LED should either turn ON or OFF after hitting the CAPS LOCK key.
Missing one of the primary colors (RED, GREEN, or BLUE)	*Inspect the monitor's video cable and make sure that none of the pins are bent.
Screen image is not centered or sized properly.	*Adjust pixel frequency CLOCK and FOCUS or press hot-key (AUTO)
Picture has color defects (white does not look white)	*Adjust RGB color or select color temperature
Horizontal or vertical disturbances on the screen	*Use win 95/98/2000/NT/ME/XP shut-down mode Adjust CLOCK and FOCUS or perform hot- key (AUTO).

- CLOCK (pixel frequency) controls the number of pixels scanned by one horizontal sweep. If the frequency is not correct, the screen shows vertical stripes and the picture has not correct width.
- FOCUS adjusts the phase of the pixel clock signal. With a wrong phase adjustment the picture has horizontal disturbances in light picture.
- For FOCUS and CLOCK adjustment use "dot-pattern" or win 95/98/2000/NT/ME/XP shut-down mode pattern.

## **ERROR MESSAGE & POSSIBLE SOLUTION**

- **CABLE NOT CONNECTED :**

1. Check that the signal-cable is properly connected, If the connector is loose, tighten the connector's screws.
2. Check the signal-cable's connection pins for damage.

- **INPUT NOT SUPPORT :**

Your computer has been set to unsuitable display mode, set the computer to display mode given in the following table.

### **FACTORY PRESET TIMING TABLE:**

VIDEO MODE		RESOLUTION	HORIZONTAL FREQUENCY (kHz)	VERTICAL FREQUENCY (Hz)
VESA	VGA	640 × 480	31.469	59.94
		640 × 480	37.500	75.00
		640 × 480	37.861	72.81
	SVGA	800 × 600	35.156	56.25
		800 × 600	37.879	60.32
		800 × 600	48.077	72.19
		800 × 600	46.875	75.00
	XGA	1024 × 768	48.363	60.00
		1024 × 768	56.476	70.07
		1024 × 768	60.023	75.03
	SXGA	1280 × 1024	63.981	60.02
		1280 × 1024	79.976	75.03
IBM	DOS	640 × 350	31.469	70.09
		640 × 400	31.469	70.09
		720 × 400	31.469	70.09
MAC		640 × 480	35.000	66.67
		832 × 624	49.725	74.55
		1152 × 870	68.681	75.06

# APPENDIX

## SPECIFICATIONS

LCD Panel	Driving system	TFT Color LCD
	Size	48.2cm(19.0")
	Pixel pitch	0.294mm(H) x 0.294mm(V)
	Brightness	270cd/m <sup>2</sup> (Typical)
	Contrast	700:1 (Typical)
	Viewable angle	150° (H) 135° (V)
	Response time	8 ms
Input	Video	R,G,B Analog Interface Digital (Dual-Input Model) H/V TTL
	H-Frequency	31KHz – 80KHz
	V-Frequency	55 – 75Hz
Display Colors		16.2M Colors
Dot Clock		135MHz
Max. Resolution		1280 x 1024 @75Hz
Plug & Play		VESA DDC2B™
EPA ENERGY STAR®	ON Mode	≤42W
	OFF Mode	≤3W
Audio output		Rated Power 1W rms (Per channel)
Input Connector		D-Sub 15pin DVI-D 24pin (Dual-Input Model)
Maximum Screen Size		Hor. :376.2mm Ver. :301.06mm
Power Source		90~264VAC,47~63HZ
Environmental Considerations		Operating Temp: 5° to 40°C Storage Temp.: -20° to 65°C Operating Humidity: 10% to 85%
Dimensions		417(W)×447(H)×198(D) mm (with stand) 417(W)×545(H)×219(D) mm (with adjustable stand)
Weight (GW/NW)		7.2 Kg / 5.7 K g (with stand) 7.6 Kg / 6.1 K g (with adjustable stand)
Regulatory Compliance		CCC, UL, TUV, BSMI, CE, CB,FCC,CUL,TCO03

## CONNECTOR PIN ASSIGNMENT

- **15 - Pin Color Display Signal Cable:**

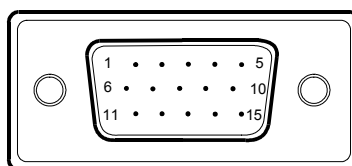

PIN NO.	DESCRIPTION	PIN NO.	DESCRIPTION
1.	Red	9.	+5V
2.	Green	10.	Ground
3.	Blue	11.	Ground
4.	Ground	12.	DDC-Serial Data
5.	Ground	13.	H-Sync
6.	R-Ground	14.	V-Sync
7.	G-Ground	15.	DDC-Serial Clock
8.	B-Ground		

- **24 - Pin Color Display Signal Cable: (Dual Input Mode)**

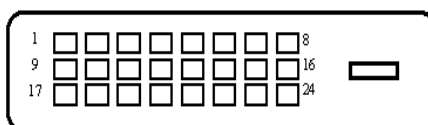

PIN NO.	DESCRIPTION	PIN NO.	DESCRIPTION
1.	TMDS Data 2-	13.	TMDS Data 3+
2.	TMDS Data 2+	14.	+5V Power
3.	TMDS Data 2/4 Shield	15.	Ground(for+5V)
4.	TMDS Data 4-	16.	Hot Plug Detect
5.	TMDS Data 4+	17.	TMDS Data 0-
6.	DDC Clock	18.	TMDS Data 0+
7.	DDC Data	19.	TMDS Data 0/5 Shield
8.	Analog Vertical sync	20.	TMDS Data 5-
9.	TMDS Data 1-	21.	TMDS Data 5+
10.	TMDS Data 1+	22.	TMDS Clock Shield
11.	TMDS Data 1/3 Shield	23.	TMDS Clock +
12.	TMDS Data 3-	24.	TMDS Clock -