

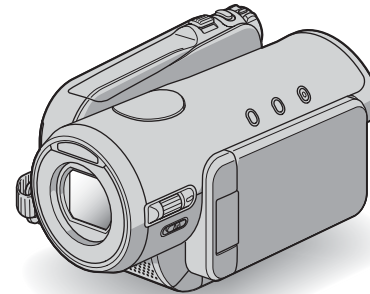

Digital HD Video Camera Recorder  
**HANDYCAM**

## Operating Guide

### HDR-HC3E



 Enjoying pictures with high definition quality 8

Getting Started 10

 Easy Handycam 22

 Recording/  
Playback 26

Using the Menu 44

Dubbing/Editing 70

Using a Computer 80

Troubleshooting 88

Additional Information 107

Quick Reference 123

Additional information on this product and answers to frequently asked questions can be found at our Customer Support Website.

<http://www.sony.net/>



Printed on 100% recycled paper using VOC (Volatile Organic Compound)-free vegetable oil based ink.

Printed in Japan

GB



2661356110

**HDV** Mini DV Digital Video Cassette   **HDMI**  
HDV 1080i

© 2006 Sony Corporation

# Read this first

Before operating the unit, please read this manual thoroughly, and retain it for future reference.

## WARNING

To reduce fire or shock hazard, do not expose the unit to rain or moisture.



## CAUTION

Replace the battery with the specified type only. Otherwise, fire or injury may result.

## FOR CUSTOMERS IN THE UNITED KINGDOM

### NOTICE ON THE SUPPLIED AC ADAPTOR

A moulded plug complying with BS1363 is fitted to this equipment for your safety and convenience.

Should the fuse in the plug supplied need to be replaced, a fuse of the same rating as the supplied one and approved by ASTA or BSI to BS1362 (i.e., marked with  or  mark) must be used.

If the plug supplied with this equipment has a detachable fuse cover, be sure to attach the fuse cover after you change the fuse. Never use the plug without the fuse cover. If you should lose the fuse cover, please contact your nearest Sony service station.

## FOR CUSTOMERS IN EUROPE

### ATTENTION

The electromagnetic fields at the specific frequencies may influence the picture and sound of this camcorder.

This product has been tested and found compliant with the limits set out in the EMC Directive for using connection cables shorter than 3 meters (9.8 feet).

## Notice

If static electricity or electromagnetism causes data transfer to discontinue midway (fail), restart the application or disconnect and connect the communication cable (USB, etc.) again.



**Disposal of Old Electrical & Electronic Equipment (Applicable in the European Union and other European countries with separate collection systems)**

This symbol on the product or on its packaging indicates that this product shall not be treated as household waste. Instead it shall be handed over to the applicable collection point for the recycling of electrical and electronic equipment. By ensuring this product is disposed of correctly, you will help prevent potential negative consequences for the environment and human health, which could otherwise be caused by inappropriate waste handling of this product. The recycling of materials will help to conserve natural resources.

For more detailed information about recycling of this product, please contact your local Civic Office, your household waste disposal service or the shop where you purchased the product.



Applicable Accessory: Remote Commander

## Notes on use

### Types of cassette you can use in your camcorder

You can use mini DV cassettes marked with . Mini DV cassettes with Cassette Memory are incompatible (p. 108).

### Types of "Memory Stick" you can use in your camcorder

There are two sizes of "Memory Stick." You can use "Memory Stick Duo" marked with  or  (p. 110).

**“Memory Stick Duo”**  
(This size can be used with your camcorder.)



**“Memory Stick”**  
(You cannot use it in your camcorder.)



- You cannot use any type of memory card except “Memory Stick Duo.”
- “Memory Stick PRO” and “Memory Stick PRO Duo” can be used only with “Memory Stick PRO” compatible equipment.

### When using a “Memory Stick Duo” with “Memory Stick” compatible equipment

Be sure to insert the “Memory Stick Duo” into the Memory Stick Duo Adaptor.

Memory Stick Duo Adaptor



### Using the camcorder

- Do not hold the camcorder by the following part.

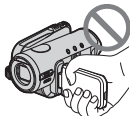

LCD panel

- The camcorder is not dustproof, dripproof or waterproof.  
See “Maintenance and precautions” (p. 114).

- Before connecting your camcorder to another device with an HDMI cable, component video cable, USB or i.LINK cable, be sure to insert the connector plug the correct way, and not forcibly to avoid damaging the terminal, or cause a malfunction of your camcorder.

### About menu items, LCD panel, viewfinder, and lens

- A menu item that is grayed out is not available under the current recording or playback conditions.
- The LCD screen and the viewfinder are manufactured using extremely high-precision technology, so over 99.99% of the pixels are operational for effective use. However, there may be some tiny black points and/or bright points (white, red, blue, or green in color) that appear constantly on the LCD screen and the viewfinder. These points are normal results of the manufacturing process and do not affect the recording in any way.

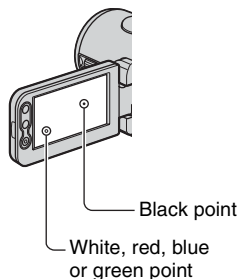

- Exposing the LCD screen, the viewfinder, or the lens to direct sunlight for long periods of time may cause malfunctions.
- Do not aim at the sun. Doing so might cause your camcorder to malfunction. Take pictures of the sun only in low light conditions, such as at dusk.

## Read this first (Continued)

### On recording

- Before starting to record, test the recording function to make sure the picture and sound are recorded without any problems.
- Compensation for the contents of recordings cannot be provided, even if recording or playback is not possible due to a malfunction of the camcorder, storage media, etc.
- TV color systems differ depending on the countries/regions. To view your recordings on a TV, you need a PAL system-based TV.
- Television programs, films, video tapes, and other materials may be copyrighted. Unauthorized recording of such materials may be contrary to the copyright laws.

### On playing back HDV tapes on other devices

You cannot play back a tape recorded in the HDV format on DV format video cameras or on mini DV players (The screen appears blue).

Check the contents of tapes by playing them back on this camcorder prior to playing them back on other devices.

### About this manual

- The images of the LCD screen and the viewfinder used in this manual for illustration purposes are captured using a digital still camera, and therefore may appear different.
- The on-screen displays in each local language are used for illustrating the operating procedures. Change the screen language before using your camcorder if necessary (p. 66).
- Design and specifications of recording media and other accessories are subject to change without notice.

### About the Carl Zeiss lens

Your camcorder is equipped with a Carl Zeiss lens, which was developed jointly by Carl Zeiss, in Germany, and Sony Corporation, and produces superior images. It adopts the MTF measurement system for video cameras and offers a quality typical of a Carl Zeiss lens. Also, the lens for your camcorder is T\*-coated to suppress unwanted reflections and faithfully reproduce colors.

MTF= Modulation Transfer Function. The number value indicates the amount of light from a subject coming into the lens.

# Table of Contents

**Note on the icons used in this manual**  
HDV1080i Features available for the HDV format only  
DV Features available for the DV format only

Read this first .....	2
-----------------------	---



## Enjoying pictures with high definition quality

Trying out the new HDV format! .....	8
Viewing video recorded in the HDV format! .....	9

## Getting Started

Step 1: Checking supplied items .....	10
Step 2: Charging the battery pack .....	11
Step 3: Turning the power on and holding your camcorder firmly .....	15
Step 4: Adjusting the LCD panel and viewfinder .....	16
Step 5: Using the touch panel .....	17
Changing the language setting .....	17
Checking the screen indicators (Display guide) .....	17
Step 6: Setting the date and time .....	19
Step 7: Inserting a tape or a "Memory Stick Duo" .....	20



## Easy Handycam - using your camcorder with automatic settings

Easy Recording/Playback (Easy Handycam) .....	22
---	----



## Recording/Playback

Recording .....	26
Playback .....	27
Functions used for recording/playback, etc. ....	28

### Recording

- To use zoom
- To record high quality still images during tape recording (Dual Rec)
- To control the image settings manually with the dial (CAM CTRL dial/MANUAL button)
- To use the flash
- To record in dark places (NightShot)
- To adjust the exposure for backlit subjects
- To record in mirror mode
- To use a tripod
- To use a Shoulder belt

## Playback

To use PB zoom

## Recording/playback

To check the remaining battery (Battery Info)







To turn off the operation confirmation beep (BEEP)

To initialize the settings (RESET)

Other part names and functions

Indicators displayed during recording/playback .....	32
Searching for the starting point .....	35
Searching for the last scene of the most recent recording (END SEARCH) .....	35
Reviewing the most recently recorded scenes (Rec review) .....	35
Remote Commander .....	36
Searching quickly for a desired scene (Zero set memory) .....	36
Searching for a scene by date of recording (Date search) .....	37
Playing the picture on a TV .....	38
High definition TV .....	38
16:9 (wide) or 4:3 TV .....	38
Connecting to a high definition TV .....	39
Connecting to a 16:9 (wide) or 4:3 TV .....	40

## Using the Menu

<i>Using the menu items</i> .....	44
Menu items .....	46
 CAMERA SET menu .....	48
Settings to adjust your camcorder to the recording conditions (EXPOSURE/ WHITE BAL./STEADYSHOT, etc.)	
 MEMORY SET menu .....	54
Settings for the "Memory Stick Duo" (QUALITY/IMAGE SIZE/ALL ERASE/ NEW FOLDER, etc.)	
 PICT.APPLI. menu .....	57
Special effects on pictures or additional functions on recording/playback (SLIDE SHOW/PICT.EFFECT/SMTH SLW REC, etc.)	
 EDIT/PLAY menu .....	60
Settings for editing or playing back in various modes (VAR.SPD PB/ END SEARCH, etc.)	
 STANDARD SET menu .....	61
Settings while recording on a tape or other basic settings (REC MODE/ MULTI-SOUND/LCD/VF SET/DISP OUTPUT/QUICK REC, etc.)	
 TIME/LANGU. menu .....	66
(CLOCK SET/WORLD TIME/LANGUAGE)	
Customizing Personal Menu .....	67
Using the CAM CTRL dial .....	68

## Dubbing/Editing

Dubbing to VCR/DVD device, etc. ....	70
Recording pictures from a VCR .....	73
Dubbing pictures from a tape to a “Memory Stick Duo” .....	75
Deleting recorded pictures from the “Memory Stick Duo” .....	76
Marking images on the “Memory Stick Duo” with specific information (Print mark/Image protection) .....	76
Printing recorded images (PictBridge compliant printer) .....	77
Jacks to connect external devices .....	79

## Using a Computer

Connecting to a computer .....	80
Copying still images to a computer .....	80
Copying movies on a tape to the computer .....	83
Creating a DVD (Direct Access to “Click to DVD”) .....	85

## Troubleshooting

Troubleshooting .....	88
Warning indicators and messages .....	103

## Additional Information

Using your camcorder abroad .....	107
Usable cassette tapes .....	108
About the “Memory Stick” .....	110
About the “InfoLITHIUM” battery pack .....	112
About i.LINK .....	113
Maintenance and precautions .....	114
Specifications .....	119

## Quick Reference

Identifying parts and controls .....	123
Index .....	126

# Trying out the new HDV format!

## Shooting in the HDV format

### High image quality

The HDV format has about 2 times the horizontal resolution of a standard TV resulting in about 4 times the amount of pixels providing high quality images.

Being HDV format compliant, your camcorder is ready to shoot crystal clear, high-definition images.

### ? What is the HDV format?

The HDV format is a new video format for shooting and playing back high definition images on popular DV standard cassette tapes.

- **Your camcorder adopts the HDV1080i specification, which utilizes 1,080 effective scanning lines, within the HDV standards,** and records pictures at the image bit rate of about 25 Mbps.



1,080 effective scanning lines

- These operating instructions refer to the HDV1080i format as HDV format unless there is a need to specify.

### ? Why shoot in the HDV format?

By moving to digital video, like the rest of the world, you will be able to capture important moments in your life in high quality digital HDV format, allowing you to relive them.

Your camcorder's down convert function converts pictures in HDV format to SD (standard definition) quality for viewing on older wide TV formats, and on 4:3 aspect ratio TVs when a high definition TV set is not available. This provides an easy path to HDV format video.

- The down convert function converts HDV format video to DV for playback or editing when your camcorder is connected to a TV or VCR that is not HDV1080i compliant. The resulting image is displayed in SD (standard definition).



# Viewing video recorded in the HDV format!



## Viewing on a high definition TV (p. 38)

Pictures recorded in the HDV format can be played back as crisp HD (high definition) pictures on a high definition TV.

- For details on Sony HDV1080i compliant TVs, see page 109.

## Viewing on a 16:9 (wide)/4:3 TV (p. 38)

Your camcorder can down convert video recorded in the HDV format to SD (standard definition) quality for playback on a conventional TV.

## Dubbing to other video devices (p. 70)

### Connecting to an HDV1080i device

An optional i.LINK cable allows you to copy pictures in HD (high definition) quality.

### Connecting to an HDV1080i non-compliant device

Your camcorder can down convert HDV format video to SD (standard definition) quality to enable copying.

## Connecting to a computer (p. 80)

### Copying “Memory Stick Duo” still images to a computer

See page 80.

### Copying movies on a tape to a computer

The computer will need to be set up differently, depending on whether HDV or DV format video is to be copied. See page 83 for details.

# Step 1: Checking supplied items

Make sure that you have following items supplied with your camcorder. The number in the parentheses indicates the number of that item supplied.

- The cassette tape and “Memory Stick Duo” are not included. See page 2, 108 and 110 for compatible cassettes and “Memory Stick Duo” for your camcorder.

AC Adaptor (1) (p. 11)

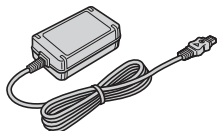

Mains lead (1) (p. 11)



Wireless Remote Commander (1) (p. 36)



A button-type lithium battery is already installed.

A/V connecting cable (1) (p. 38, 70)



Component video cable (1) (p. 38)

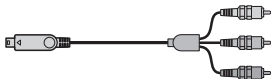

USB cable (1) (p. 77, 80)



Rechargeable battery pack NP-FP60 (1) (p. 11, 112)

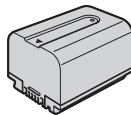

Battery terminal cover (1)

Attached to the camcorder.

Operating Guide (This manual) (1)

## Step 2: Charging the battery pack

You can charge the “InfoLITHIUM” battery pack (P series) (p. 112) after attaching it to your camcorder.

- You cannot use the battery pack NP-FP30 with your camcorder (confirm the battery model on the back of the battery pack). If you attach it forcibly to your camcorder, the battery pack may be damaged or cannot be detached, and it may cause a malfunction of your camcorder.

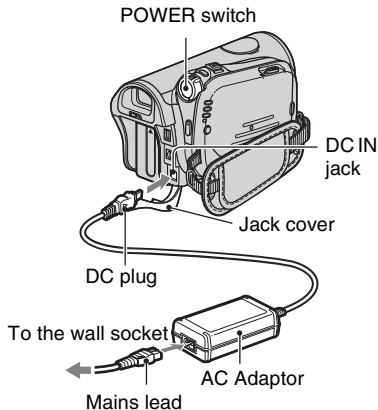

- You can operate your camcorder connected to a power source such as a wall socket as shown in the illustration. The battery pack will not lose its charge in this case.

### 1 Attach the battery pack to your camcorder.

- ① Slide the BATT (battery release) lever and remove the battery terminal cover.

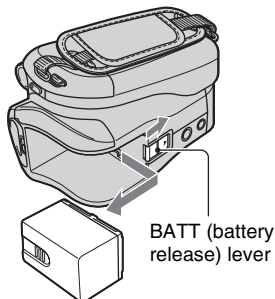

- ② Attach the battery pack by sliding it in the direction of the arrow until it clicks.

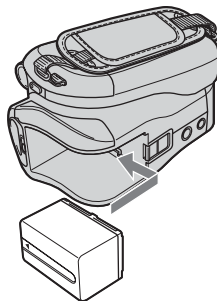

## Step2: Charging the battery pack (Continued)

- 2** Slide the **POWER** switch in the direction of the arrow to **OFF (CHG)** (The default setting).

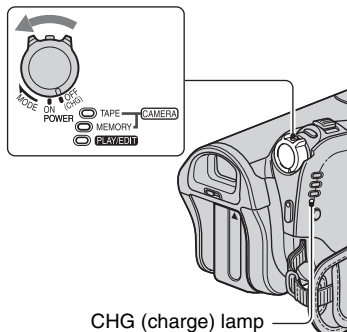

- 3** Connect the **AC Adaptor** to the **DC IN jack** of your camcorder. Be sure that the **▲** mark on the DC plug is facing to the **▲** mark on your camcorder.

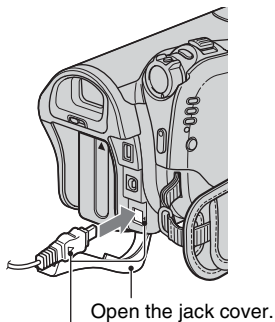

Match the **▲** mark on the DC plug with the **▲** mark on your camcorder.

- 4** Connect the mains lead to the **AC Adaptor** and the wall socket.

The CHG (charge) lamp lights up and charging starts. The CHG (charge) lamp turns off when the battery is fully charged.

- 5** Disconnect the **AC Adaptor** from the **DC IN jack** on your camcorder.

Disconnect the AC Adaptor from the DC IN jack holding both the camcorder and the DC plug.

### To remove the battery pack

Slide the **POWER** switch to **OFF (CHG)**. Slide the **BATT** (battery release) lever and remove the battery pack.

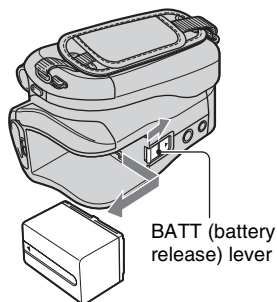

### When storing the battery pack

Attach the battery terminal cover to protect the battery terminal. Fully discharge the battery before storing it for an extended period (see page 112 for the details of storage).

## Charging time

Approximate time (min.) required when you fully charge a fully discharged battery pack.

Battery pack	Charging time
NP-FP50	125
NP-FP60 (supplied)	135
NP-FP70	155
NP-FP71	170
NP-FP90	220

## Recording time

Approximate time (min.) available when you use a fully charged battery pack.

### Recording in the HDV format

Battery pack	Continuous recording time	Typical recording time*
NP-FP50	60	30
	65	35
	65	35
NP-FP60 (supplied)	95	50
	105	55
	105	55
NP-FP70	135	70
	145	75
	145	75
NP-FP71	160	85
	175	95
	175	95
NP-FP90	240	130
	260	140
	260	140

### Recording in the DV format

Battery pack	Continuous recording time	Typical recording time*
NP-FP50	65	30
	70	35
	70	35
NP-FP60 (supplied)	100	55
	110	60
	110	60
NP-FP70	135	70
	150	80
	150	80
NP-FP71	165	90
	180	95
	180	95
NP-FP90	250	135
	270	145
	270	145

- All times measured under the following conditions:

Top: When the LCD backlight turns on.

Middle: When the LCD backlight turns off.

Bottom: Recording time when recording with the viewfinder while the LCD panel is closed.

- \* Typical recording time shows the time when you repeat recording start/stop, turning the power on/off and zooming.

## Playing time

Approximate time (min.) available when you use a fully charged battery pack.

### HDV format pictures

Battery pack	LCD panel opened*	LCD panel closed
NP-FP50	75	80
NP-FP60 (supplied)	115	125
NP-FP70	160	175
NP-FP71	195	205
NP-FP90	290	310

## Step2: Charging the battery pack (Continued)

### DV format pictures

Battery pack	LCD panel opened*	LCD panel closed
NP-FP50	85	90
NP-FP60 (supplied)	130	140
NP-FP70	180	190
NP-FP71	215	230
NP-FP90	320	345

\* When the LCD backlight turns on.

### On the battery pack

- Before changing the battery pack, slide the POWER switch to OFF (CHG).
- The CHG (charge) lamp flashes during charging, or Battery Info (p. 30) will not be correctly displayed under the following conditions.
  - The battery pack is not attached correctly.
  - The battery pack is damaged.
  - The battery pack is worn-out (For Battery Info only).
- The power will not be supplied from the battery as long as the AC Adaptor is connected to the DC IN jack of your camcorder, even when the mains lead is disconnected from the wall socket.
- When attaching an optional video light, it is recommended that you use a NP-FP60, NP-FP70, NP-FP71 or NP-FP90 battery pack.

### On the charging/recording/playback time

- Times measured with the camcorder at 25 °C (77 °F) (10 to 30 °C (50 °F to 86 °F) is recommended).
- The recording and playback time will be shorter when you use your camcorder in low temperatures.
- The recording and playback time will be shorter depending on the conditions under which you use your camcorder.

### On the AC Adaptor

- Use the nearby wall socket when using the AC Adaptor. Disconnect the AC Adaptor from the wall socket immediately if any malfunction occurs while using your camcorder.
- Do not use the AC Adaptor placed in a narrow space, such as between a wall and furniture.

- Do not short-circuit the DC plug of the AC Adaptor or battery terminal with any metallic objects. This may cause a malfunction.

### PRECAUTION

- Even if your camcorder is turned off, AC power (mains) is still supplied to it while connected to the wall socket via the AC Adaptor.

## Step 3: Turning the power on and holding your camcorder firmly

To record or play back, slide the POWER switch repeatedly to turn on the respective lamp.

When using it for the first time, the [CLOCK SET] screen appears (p. 19).

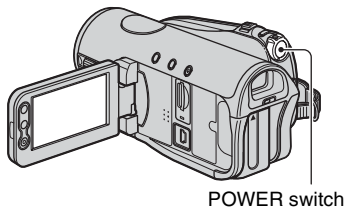

- 1 Slide the POWER switch repeatedly in the direction of the arrow to turn on the respective lamp.

The lens cover opens automatically when the POWER switch is set to CAMERA-TAPE or CAMERA-MEMORY.

If the POWER switch is set to OFF (CHG), slide it while pressing the green button.

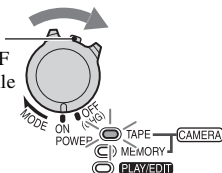

### Lamps that light up

**CAMERA-TAPE:** To record on a tape.

**CAMERA-MEMORY:** To record on a "Memory Stick Duo."

**PLAY/EDIT:** To play or edit pictures.

- After you have set the date and time ([CLOCK SET], p. 19), the next time you turn on the power of your camcorder, the current date and time will be displayed on the LCD screen for a few seconds.

- 2 Hold the camcorder correctly.

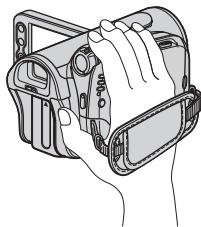

- 3 Ensure a good grip, then fasten the grip belt.

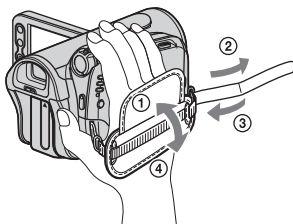

The length of the grip belt is adjustable.

### To turn off the power

Slide the POWER switch to OFF (CHG).

- At the time of purchase, the power will be set to turn off automatically if you leave your camcorder without any operation attempted for approximately 5 minutes, to save battery power ([A.SHUT OFF], p. 66).
- If warning messages appear on the screen, follow the instructions (p. 104).

# Step 4: Adjusting the LCD panel and viewfinder

## The LCD panel

Open the LCD panel 90 degrees to the camcorder (①), then rotate it to the best angle to record or play (②).

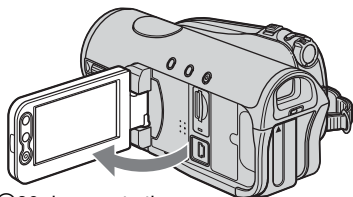

①90 degrees to the camcorder

②180 degrees (max.)

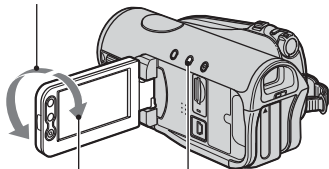

②90 degrees (max.)

DISP/BATT INFO

- Do not press the buttons on the LCD panel accidentally when you open or adjust the LCD panel.
- If you rotate the LCD panel 180 degrees to the lens side from the status ①, you can close the LCD panel with the LCD screen facing out. This is convenient during playback operations.
- When closing the LCD panel, rotate the LCD panel to the position as illustrated in ①, and then close the LCD panel facing inward.

## To turn off the LCD backlight to make the battery last longer

Press and hold DISP/BATT INFO for a few seconds until  $\square_{OFF}$  appears.

This setting is practical when you use your camcorder in bright conditions or where you want to save battery power. The recorded picture will not be affected by the setting. To turn on the LCD backlight, press and hold DISP/BATT INFO for a few seconds until  $\square_{OFF}$  disappears.

- See [LCD/VF SET] - [LCD BRIGHT] (p. 63) to adjust the brightness of the LCD screen.

## The viewfinder

You can view pictures using the viewfinder to avoid wearing down the battery, or when the picture seen on the LCD screen is poor.

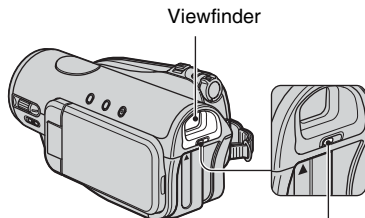

Viewfinder lens adjustment lever  
Move it until the picture is clear.

- You can adjust the brightness of the viewfinder backlight by selecting [LCD/VF SET] - [VF B.LIGHT] (p. 63).



## Step 5: Using the touch panel

You can play back recorded pictures (p. 27), or change the settings (p. 44) using the touch panel.

**Place your hand on the rear side of the LCD panel to support it. Then, touch the buttons displayed on the screen.**

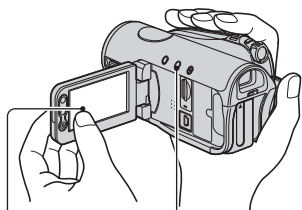

DISP/BATT INFO

Touch the button on the LCD screen.

- Perform the same actions as explained above when you press the buttons on the LCD panel.
- Be careful not to press buttons on the LCD panel accidentally while using the touch panel.
- If the buttons on the touch panel do not work correctly, adjust the LCD screen (CALIBRATION) (p. 116).

### To hide the screen indicators

Press DISP/BATT INFO to toggle the screen indicators (such as time code) on or off.

### Changing the language setting

You can change the on-screen displays to show messages in a specified language. Select the screen language in [LANGUAGE] on the (TIME/LANGU.) menu (p. 66).

### Checking the screen indicators (Display guide)

You can easily check the meaning of each indicator that appears on the LCD screen (p. 34).

#### 1 Touch [P-MENU].

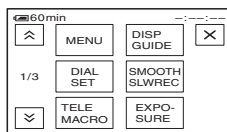

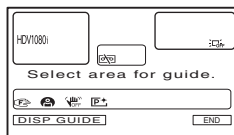

Touch [MENU] during Easy Handycam operation (p. 22).

#### 2 Touch [DISP GUIDE].



The indicators vary depending on the settings.

### 3 Touch the area including the indicator that you want to check.

The meanings of the indicators in the area are listed on the screen. If you cannot find the indicator you want to check, touch / to toggle.

When you touch , the screen returns to the area selecting display.

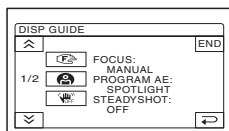

### To finish the operation

Touch [END].

## Step 6: Setting the date and time

Set the date and time when using this camcorder for the first time. If you do not set the date and time, the [CLOCK SET] screen appears every time you turn on your camcorder or change the POWER switch position.

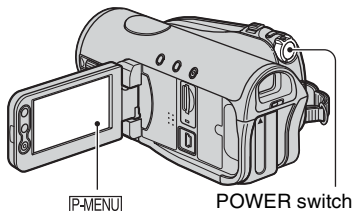

- If you do not use your camcorder for **about 3 months**, the built-in rechargeable battery gets discharged and the date and time settings may be cleared from the memory. In that case, charge the rechargeable battery and then set the date and time again (p. 117).

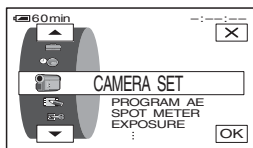

Skip to step 4 when you set the clock for the first time.

- 1 Touch [P-MENU] → [MENU].



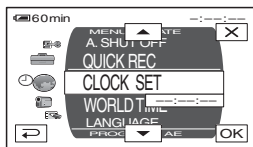

- 2 Select  (TIME/LANGU.) menu with /, then touch [OK].

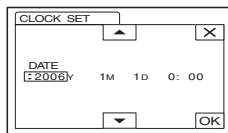

- 3 Select [CLOCK SET] with /, then touch [OK].



- 4 Set [Y] (year) with /, then touch [OK].

You can set any year up to the year 2079.

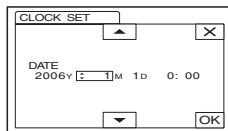

- 5 Set [M] (month), [D] (day), hour and minute, then touch [OK].

The clock starts.

- The date and time does not appear during recording, but they are automatically recorded on the tape, and can be displayed during playback (see page 64 for [DATA CODE] (during Easy Handycam operation, you can set only [DATE/TIME])).

# Step 7: Inserting a tape or a “Memory Stick Duo”

## Cassette tape

You can use mini DV **Mini DV** cassettes only (p. 108).

- The recordable time varies depending on [RECORD MODE] (p. 62). **DV**

- 1 Slide and hold the **OPEN/EJECT** lever in the direction of the arrow and open the lid.

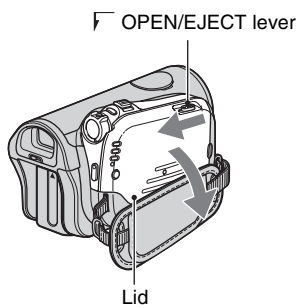

The cassette compartment automatically comes out and opens up.

- 2 Insert a cassette with its window facing outwards, then press **PUSH**.

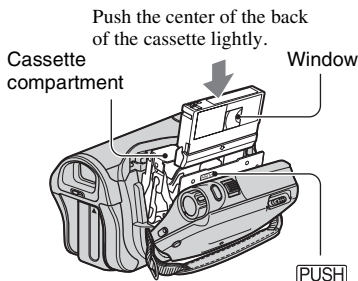

The cassette compartment automatically slides back in.

- Do not force the cassette compartment closed by pressing the portion marked **DO NOT PUSH** while it is sliding in. It may cause a malfunction.

- 3 Close the lid.

## To eject the cassette

Open the lid following the same procedure as described in step 1 and remove the cassette.

## “Memory Stick Duo”

You can use only a “Memory Stick Duo” marked with **MEMORY STICK DUO** or **MEMORY STICK PRO DUO** (p. 110).

- The number and time of recordable pictures vary, depending on the image quality or the image size. For details, see page 54.

- 1 Open the LCD panel.

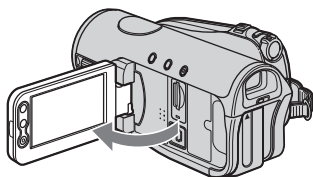

- 
- 2** Insert the “Memory Stick Duo” into the “Memory Stick Duo” slot in the right direction until it clicks.

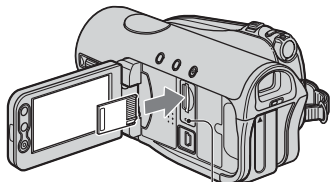

Access lamp

- If you force the “Memory Stick Duo” into the slot in the wrong direction, the “Memory Stick Duo,” the “Memory Stick Duo” slot, or image data may be damaged.

---

### To eject a “Memory Stick Duo”

Lightly push the “Memory Stick Duo” in once.

- When the access lamp is lit or flashing, your camcorder is reading/writing data. Do not shake or knock your camcorder, turn the power off, eject the “Memory Stick Duo,” or remove the battery pack. Otherwise, image data may be damaged.
- When inserting or ejecting the “Memory Stick Duo,” be careful that the “Memory Stick Duo” does not pop out and drop.



# Easy Recording/Playback (Easy Handycam)

With this Easy Handycam operation, most of the camera settings are automatically optimally adjusted, which frees you from detailed adjustments. The screen font size increases for easy viewing.

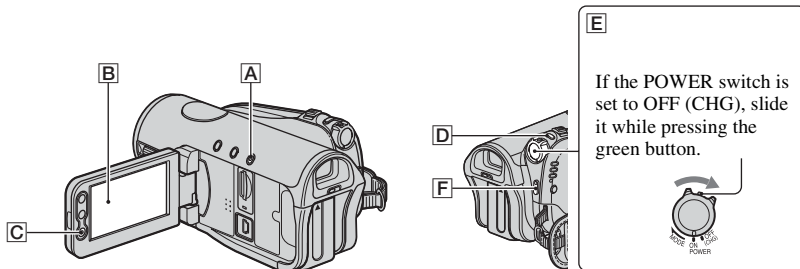

## Movies

**1** Slide the **POWER** switch **E** to turn on the **CAMERA-TAPE** lamp.

If the **POWER** switch is set to **OFF (CHG)**, slide it while pressing the green button.

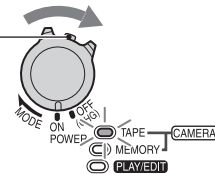

**2** Press **EASY** **A**.

**EASY** appears on the screen **B**.

**3** Press **START/STOP** **F** or **C** to start recording.



To stop recording, press **F** or **C** again.

## Still images ◀

### 1 Slide the POWER switch **E** to turn on the CAMERA-MEMORY lamp.

If the POWER switch is set to OFF (CHG), slide it while pressing the green button.

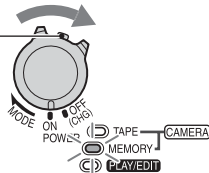

### 2 Press EASY **A**.

**EASY** appears on the screen **B**.

### 3 Press PHOTO **D** to record.\*

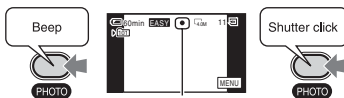

Flashing → Lit

Press and hold lightly  
to adjust the focus.

Press fully to record.

When **||||** disappears, the image has been recorded.

\* Still images are recorded in [FINE] quality on a "Memory Stick Duo."

### To record high quality still images during tape recording (Dual Rec)

Slide the POWER switch **E** to turn on the CAMERA-TAPE lamp, then press PHOTO **D** fully during tape recording.

For each separate time tape recording, up to 3 still images can be recorded. After tape recording, stored still images are stored onto the "Memory Stick Duo" (p. 28).

- Do not eject "Memory Stick Duo" before tape recording is finished and the still images are stored on the "Memory Stick Duo."

## Playing back movies/still images

Slide the **POWER** switch **[E]** to turn on the **PLAY/EDIT** lamp. Touch the buttons on the touch panel **[B]** as follows.



### Movies

Touch **[REWIND]**, then touch **[PLAY/PAUSE]** to start playback.

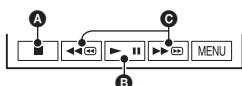

- A** Stop
- B** Play/Pause toggles
- C** Rewind/Fast forward

### Still images

Touch **[MEMORY]** → **[−/ +]** to select a picture.

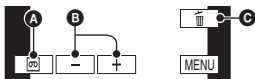

- A** Tape playback
- B** Previous/Next
- C** Delete (p. 76)

## ■ To cancel Easy Handycam operation

Press **EASY** **[A]** again. **EASY** disappears from the screen.

## ■ Adjustable menu settings during Easy Handycam operation

Touch **[MENU]** to display adjustable menu settings. See page 45 for details on settings.

- Almost all the settings return to the default setting automatically (p. 46).
- **[P-MENU]** is not displayed during Easy Handycam operation.
- Cancel Easy Handycam operation if you want to add any effects or settings to the images.

## ■ Unavailable buttons during Easy Handycam

During Easy Handycam operation, the following buttons/dial are unavailable, since the items are set automatically. [Invalid during Easy Handycam operation] may appear if operations not available during Easy Handycam are attempted.

- **BACK LIGHT** button (p. 29)
- Pressing and holding **DISP/BATT INFO** button (p. 16)
- **CAM CTRL** dial (p. 29)
- **MANUAL** button (p. 29)





# Recording

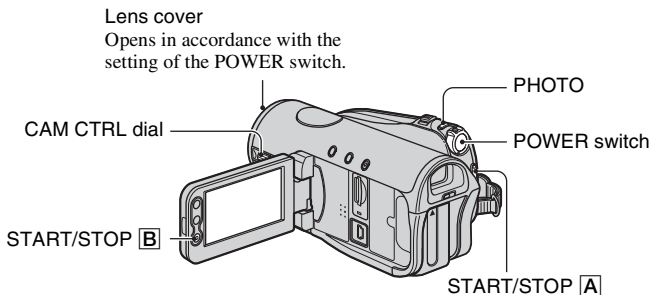

- 1** Slide the **POWER** switch in the direction of the arrow repeatedly to turn on the respective lamp to select a recording medium.

**Movies on tape:** The CAMERA-TAPE lamp lights up.

**Still images on “Memory Stick Duo”:** The CAMERA-MEMORY lamp lights up.\*

\* The image size ratio is set by default to 4:3.

If the **POWER** switch is set to **OFF (CHG)**, slide it while pressing the green button.

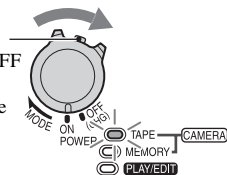

## 2 Start recording.

### Movies

Press **START/STOP [A]** (or **[B]**).

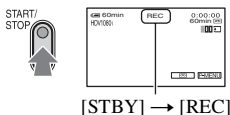

To stop the movie recording, press **START/STOP** again.

- The pictures are recorded in the HDV format in the default setting (p. 62).

### Still images

Press and hold **PHOTO** lightly to adjust the focus (**A**), then press it fully (**B**).

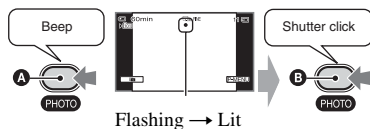

A shutter sound is heard. When disappears, the image has been recorded.

## To record high quality still images during tape recording (Dual Rec)

See page 28.

## To check the latest recording on a “Memory Stick Duo”

Touch . To delete the picture, touch → [YES].

- See page 54 for the image size.

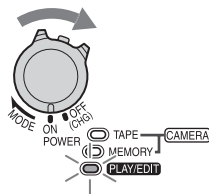

# Playback

- 1** Slide the **POWER** switch in the direction of the arrow repeatedly to turn on the **PLAY/EDIT** lamp.



- 2** Start playing back.

## Movies

Touch  to rewind the tape to the desired point, then touch  to start playback.

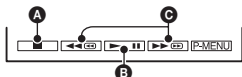



- A** Stop
- B** Play/Pause toggles as you touch it
  - Playback automatically stops if pause is engaged for more than 3 minutes.
- C** Rewind/Fast forward
  - **MEMORY** is not displayed when a “Memory Stick Duo” is inserted or no image files exist in it.

## Still images

Touch **MEMORY**.

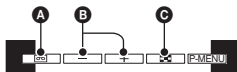
The most recently recorded image is displayed.







- A** Tape playback
- B** Previous/Next
- C** Index screen display
  - When a “Memory Stick Duo” is inserted, **MEMORY** appears by touching .

## To adjust the volume

Rotate the CAM CTRL dial to adjust the volume (p. 29).

- You can also adjust the volume on the menu (p. 63).



## To search for a scene during playback

Touch and hold / during playback (Picture Search), or / while fast forwarding or rewinding the tape (Skip Scan).

- You can play back in various modes ( VAR. SPD PB), p. 60).

## To display pictures on a “Memory Stick Duo” on the Index screen

Touch . Touch one of the pictures to back to the single display mode.

To view pictures in other folders, touch  → **SET** → **[PB FOLDER]**, select a folder with /, then touch **OK** (p. 56).

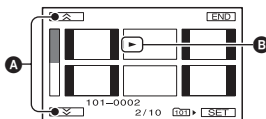

- A** Previous/Next 6 pictures
- B** The picture displayed before switching to the index screen.

# Functions used for recording/playback, etc.

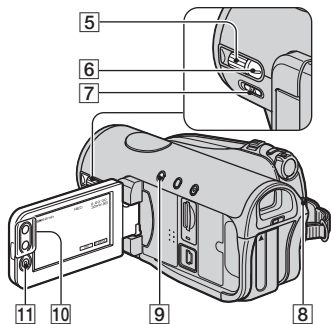
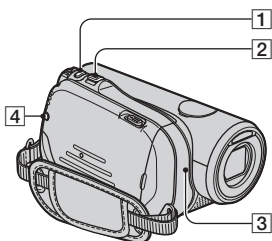

## Recording

### To use zoom ..... [2] [10]

Move the power zoom lever [2] slightly for a slower zoom. Move it further for a faster zoom.

#### Wider range of view: (Wide angle)

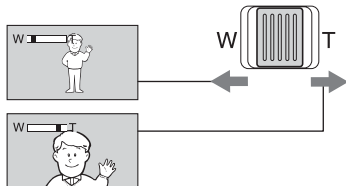

#### Close view: (Telephoto)

- You cannot change the zoom speed with the zoom buttons [10] on the LCD panel.
- The minimum possible distance between camcorder and subject while maintaining sharp

focus is about 1 cm (about 13/32 in.) for wide angle and about 80 cm (about 2 5/8 feet) for telephoto.

- You can set [DIGITAL ZOOM] (p. 53) if you want to zoom to a level greater than 10 x.
- Be sure to keep your finger on the power zoom lever. If you move your finger off the power zoom lever, the operation sound of the power zoom lever may also be recorded.

### To record high quality still images during tape recording (Dual Rec)

..... [1] [8] [11]

You can record high quality still images on the "Memory Stick Duo" during tape recording.

- ① Press START/STOP [8], [11] to start tape recording.
- ② Press PHOTO [1] fully.

For each separate time tape recording, up to 3 still images can be recorded.



Orange color boxes indicate the number of recorded images. When recording is finished, the color changes to orange.

- ③ Press START/STOP [8], [11] to stop tape recording.

Stored still images appear one by one, and the images are stored onto the "Memory Stick Duo." When [||||] disappears, the image has been recorded.

- When the POWER switch is set to CAMERA-TAPE, still images will be recorded at image size 2.3M in the HDV format, 1.7M (4:3) or 2.3M (16:9) in the DV format.
- Do not eject the "Memory Stick Duo" before tape recording is finished and the still images are stored on the "Memory Stick Duo."
- You cannot use the flash during Dual Rec.
- During the standby mode, still images will be stored in the same way as when the POWER switch is set to CAMERA-MEMORY. You can use the flash.

## To control the image settings manually with the dial (CAM CTRL dial/MANUAL button) ..... 5 6

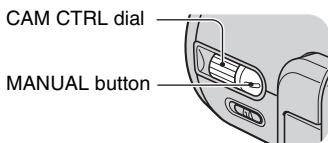

You can assign some of the camera settings to the CAM CTRL dial [5] such as focus adjustment (default setting). See page 68 for details.

During playback, you can adjust the volume using the CAM CTRL dial [5] (p. 27).

- At the time of purchase, the [FOCUS] (p. 50) setting is assigned to the CAM CTRL dial [5]. If you press the MANUAL button [6], you can switch from the auto setting to the manual setting and adjust the focus manually.

## To use the flash ..... 4

Press  (flash) [4] repeatedly to select an appropriate setting.

↓  
No indication (Auto flash): Automatically flashes when there is insufficient ambient light.

↓  
 (Forced flash): Always uses the flash regardless of the surrounding brightness.

↓  
 (No flash): Records without flash.

- The recommended distance to the subject when using the built-in flash is 0.5 to 2.5 m (1 5/8 to 8 feet).
- Remove any dust from the surface of the flash lamp before using it. Flash effect may be impaired if heat discoloration or dust obscures the lamp.
- The flash charge lamp flickers when charging the flash, and remains lit when the battery charge is complete. (In [STBY] of the CAMERA-TAPE mode, it takes a while to fully charge the flash lamp.)
- You cannot use the flash during tape recording.

- If you use the flash in bright places such as when shooting a backlit subject, the flash may not be effective.
- When attaching a conversion lens (optional) or a filter (optional) to your camcorder, the flash light does not emit light.
- You can change the brightness of the flash by setting [FLASH LEVEL], or you can prevent the redeye by setting [REDEYE REDUC], in [FLASH SET] (p. 51).

## To record in dark places (NightShot) ..... 7

Set the NIGHTSHOT switch [7] to ON. ( and ["NIGHTSHOT"] appear.)

- To record an image brighter, use Super NightShot function (p. 51). To record an image more faithful to the original colors, use Color Slow Shutter function (p. 52).
- The NightShot and Super NightShot function use infrared light. Therefore, do not cover the infrared port [3] with your fingers or other objects and remove the conversion lens (optional).
- Adjust the focus manually ([FOCUS], p. 50) when it is hard to focus automatically.
- Do not use these functions in bright places. This may cause a malfunction.

## To adjust the exposure for backlit subjects ..... 9

To adjust the exposure for backlit subjects, press BACK LIGHT [9] to display . To cancel the back light function, press BACK LIGHT again.

- The setting you have made will return to the default setting if you set the POWER switch to OFF (CHG) for more than 12 hours.

## Functions used for recording/playback, etc. (Continued)

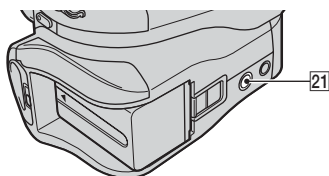
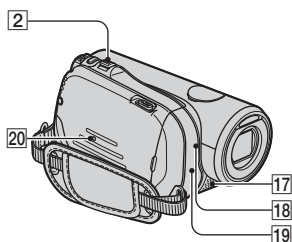
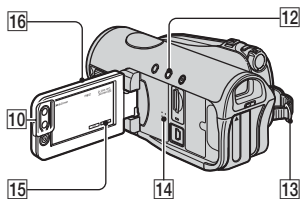

### To record in mirror mode ..... 16

Open the LCD panel 16 90 degrees to the camcorder (1), then rotate it 180 degrees to the lens side (2).

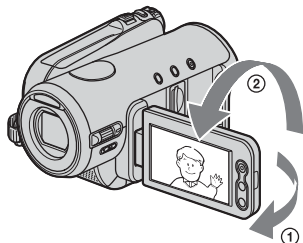

- A mirror-image of the subject appears on the LCD screen, but the picture will be normal when recorded.

### To use a tripod ..... 21

Attach the tripod (optional: the length of the screw must be less than 5.5 mm (7/32 in.)) to the tripod receptacle 21 using a tripod screw.

### To use a Shoulder belt ..... 13

Attach the Shoulder belt (optional) to its designated hook 13.

## Playback

### To use PB zoom ..... 2 10

You can magnify images from about 1.1 to 5 times (from about 1.5 to 5 times in still images) the original size.

Magnification can be adjusted with the power zoom lever 2 or the zoom buttons 10 on the LCD panel.

- 1 Play back the picture you want to magnify.
- 2 Magnify the picture with T (Telephoto).
- 3 Touch the screen at the point you want to display in the center of the displayed frame.
- 4 Adjust the magnification with W (Wide angle)/T (Telephoto).

To cancel, touch [END].

- You cannot change the zoom speed with the zoom buttons 10 on the LCD panel.

## Recording/playback

### To check the remaining battery (Battery Info)..... 12

Set the POWER switch to OFF (CHG), then press DISP/BATT INFO 12. The approximate recordable time in the selected format and battery information appear for about 7 seconds. You can view the battery information for up to 20 seconds by

pressing DISP/BATT INFO again while the information is displayed.

Remaining battery (approx.)

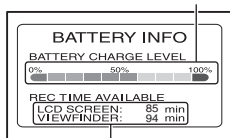

Recording capacity (approx.)

## To turn off the operation confirmation beep (BEEP) ..... 15

See [BEEP] on page 65.

## To initialize the settings (RESET) ..... 20

Press RESET [20] to initialize all the settings, including the setting of the date and time.

(Menu items customized on Personal Menu are not initialized.)

## Other part names and functions

### 14 Speaker

Playback sounds come out from the speaker.

- For how to adjust the volume, see page 27.

### 17 Internal stereo microphone

An Active Interface Shoe compatible microphone (optional) will take precedence when connected.

### 18 REC lamp

The REC lamp lights up in red during recording (p. 65).

The REC lamp flashes if the remaining tape or battery power is low.

### 19 Remote sensor

Point the Remote Commander (p. 36) towards the remote sensor to operate your camcorder.

# Indicators displayed during recording/playback

## Recording movies

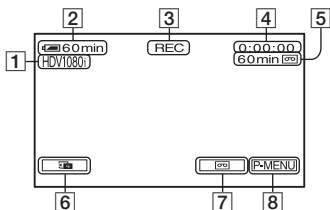

- 1 Recording format (HDV1080i or DV) (62)  
Recording mode (SF or LP) is also displayed in the DV format.
- 2 Remaining battery (approx.)
- 3 Recording status ([STBY] (standby) or [REC] (recording))
- 4 During recording:  
Tape counter (hour: minute: second)  
During playback:  
Time code (hour: minute: second: frame)
- 5 Recording capacity of the tape (approx.) (65)
- 6 Review button for still images on the “Memory Stick Duo” (28)  
Appears when “Memory Stick Duo” is inserted.
- 7 END SEARCH/Rec review display switch button (35)
- 8 Personal Menu button (44)

## Recording still images during tape recording (Dual Rec)

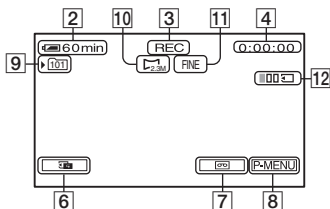

- 9 Recording folder (56)
- 10 Image size (54)
- 11 Quality ([FINE] or [STD]) (54)
- 12 Number of recorded still images (28)

## Recording still images

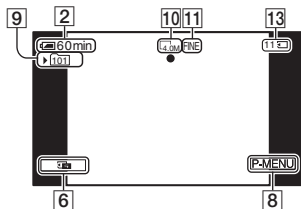

- 13 “Memory Stick Duo” indicator and the number of images that can be recorded (approx.)

## Data code during recording

The date/time during recording and the camera setting data will be recorded automatically. They do not appear on the screen during recording, but you can check them as [DATA CODE] during playback (p. 64).



( ) is a reference page.

The indicators during recording will not be recorded.

## Viewing movies

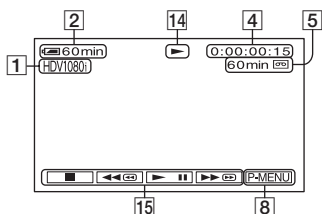

- 14 Tape transport indicator
- 15 Video operation buttons (27)

## Viewing still images

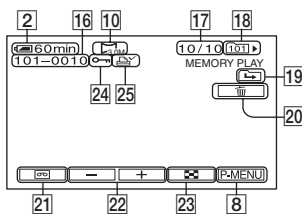

- 16 Data file name
- 17 Picture number/Total number of recorded pictures in the current playback folder
- 18 Playback folder (56)
- 19 Previous/Next folder icon  
The following indicators appear when the first or last picture of the current folder is displayed and when there are multiple folders on the same "Memory Stick Duo."
  - : Touch to move to the previous folder.
  - : Touch to move to the next folder.
  - : Touch to move to either the previous or the next folder.
- 20 Image delete button (76)
- 21 Tape playback select button (27)
- 22 Previous/Next image button (27)
- 23 Index screen display button (27)
- 24 Image protection mark (77)
- 25 Print mark (76)

## Indicators when you made changes

You can use the [DISP GUIDE] (p. 17) to check the function of each indicator that appears on the LCD screen.

- Some of the indicators may not appear when you use [DISP GUIDE].

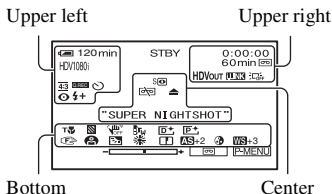

### Upper left

Indicator	Meaning
HDV1080i DV	Recording format (61)
16b	AUDIO MODE (62)*
SP LP	Recording mode (62)*
☺	Self-timer recording (52)
4:3	WIDE SELECT (62)*
Q.REC	QUICK REC (66)**
📷	Interval photo recording (59)
🔋 🔌 🔌 🔌 🔌	Flash light (51)

### Upper right

Indicator	Meaning
HDVIN DVIN	HDV input/ DV input (74)
HDVout DVout	HDV output/ DV output (39, 72)
i.LINK	i.LINK connection (38, 72, 74)
+0+	Zero set memory (36)
all [ ] ↺	Slide show (57)
☺ OFF	LCD backlight off (16)

## Center

Indicator	Meaning
📷	Color Slow Shutter (52)
🔗	PictBridge connecting (77)
🚨 🗣️ 🙅	Warning (103)
📷	NightShot (29)
S📷	Super NightShot (51)

## Bottom

Indicator	Meaning
AS	AE SHIFT (50)
WS	WB SHIFT (50)
P+	Picture effect (58)
D+	Digital effect (57)
📷 🗣️ 🙅	Manual focus (50)
📷 🗣️ 🙅	PROGRAM AE (48)
📷	Sharpness (50)
📷	Backlight (29)
☀️ 🌙 📷	White balance (49)
📷	SteadyShot off (53)
📷	Zebra (52)
T📷	Tele macro (51)
📷	CAMERA COLOR (50)
D <sub>W</sub> D <sub>F</sub>	CONV.LENS (53)
— —	SPOT METER (48)/ EXPOSURE (49)

\* The settings can be made only for the pictures in the DV format.

\*\* The setting can be made only for the pictures in the HDV format.

## Other indicator

Indicator	Meaning
📷	Information (104)

# Searching for the starting point

Make sure that the **CAMERA-TAPE** lamp lights up (p. 26).

## Searching for the last scene of the most recent recording (END SEARCH)

END SEARCH will not work once you eject the cassette after you have recorded on the tape.

Touch  → .

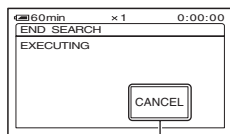

Touch here to cancel the operation.

The last scene of the most recent recording is played back for about 5 seconds, and the camcorder enters the standby mode at the point where the last recording has finished.

- END SEARCH will not work correctly when there is a blank section between recorded sections on the tape.
- You can also select [END SEARCH] from the menu. When the PLAY/EDIT lamp lights up, select the [END SEARCH] short-cut in Personal Menu (p. 44).

## Reviewing the most recently recorded scenes (Rec review)

You can view about 2 seconds of the scene recorded just before you stopped the tape.

Touch  → .

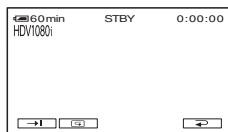

The last 2 seconds (approx.) of the most recently recorded scene are played back. Then, your camcorder is set to the standby.

# Remote Commander

Remove the insulation sheet before using the Remote Commander.

Insulation sheet

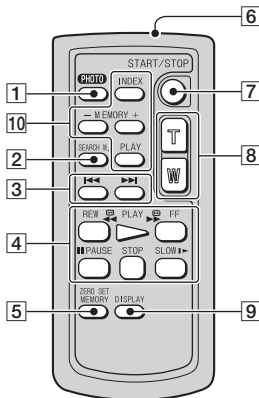
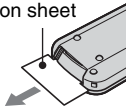

## 1 PHOTO (p. 26)

The on-screen image when you press this button will be recorded onto the “Memory Stick Duo” as a still image.

## 2 SEARCH M. (p. 37)\*

## 3 ◀▶\*

4 Video control buttons (Rewind, Playback, Fast-forward, Pause, Stop, Slow) (p. 27)

## 5 ZERO SET MEMORY\*

## 6 Transmitter

## 7 START/STOP (p. 22, 26)

## 8 Power zoom (p. 28, 30)

## 9 DISPLAY (p. 17)

## 10 Memory control buttons (Index\*, +/-, Memory playback) (p. 27)

\* These buttons are not available during Easy Handycam operation.

- Aim the Remote Commander towards the remote sensor to operate your camcorder (p. 31).
- To change the battery, see page 117.

## Searching quickly for a desired scene (Zero set memory)

### 1 During playback, press ZERO SET MEMORY [5] at a point you want to locate later on.

The tape counter is reset to “0:00:00” and +0+ appears on the screen.

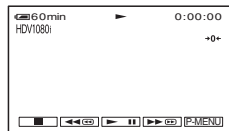

If the tape counter is not displayed, press DISPLAY [9].

### 2 Press STOP [4] when you want to stop playback.

### 3 Press ◀REW [4].

The tape stops automatically when the tape counter reaches “0:00:00.”

The tape counter returns to the time code display, and the zero set memory display disappears.

### 4 Press PLAY [4].

Playback starts from the point designated “0:00:00” on the tape counter.

## To cancel the operation

Press ZERO SET MEMORY **[5]** again before rewinding.

- There may be a discrepancy of several seconds between the time code and the tape counter.
- Zero set memory will not function correctly if there is a blank section between recorded sections on the tape.

## Searching for a scene by date of recording (Date search)

You can locate the point where the recording date changes.

---

**1** Slide the **POWER** switch repeatedly to turn on the **PLAY/EDIT** lamp.

---

**2** Press **SEARCH M.** **[2]**.

---

**3** Press **◀◀(Previous)/▶▶(Next)** **[3]** to select a recording date.

---

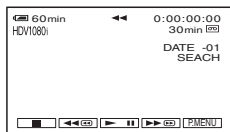

## To cancel the operation

Press **STOP** **[4]**.

- The Date search will not function correctly when there is a blank section between recorded sections on the tape.

# Playing the picture on a TV

Connection methods and image quality differ depending on what type of TV is connected and connectors used.

Use the supplied AC Adaptor as the power source (p. 11).

Refer also to the instruction manuals supplied with the device to be connected.

- Cancel Easy Handycam operation (p. 24) before connecting.

## Selecting the connection method according to your TV type and connectors

### High definition TV

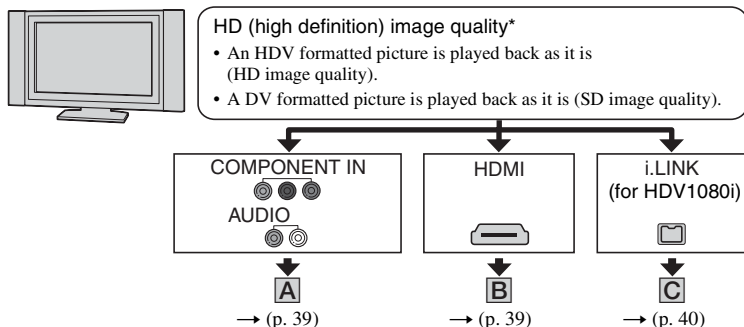

### 16:9 (wide) or 4:3 TV

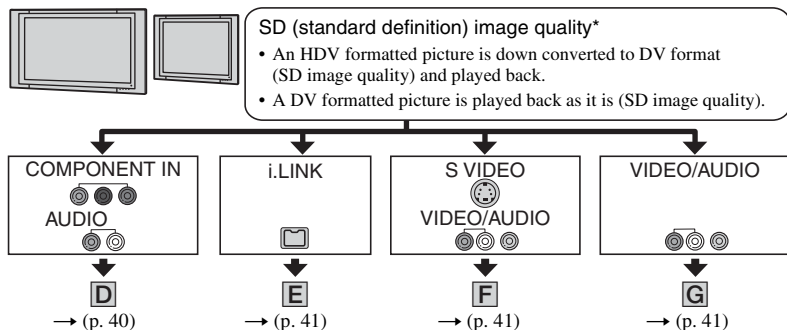

- Make all menu settings on your camcorder before connecting. The TV may not recognize the video signal properly when changing [VCR HDV/DV] and [i.LINK CONV] settings after connecting with an i.LINK cable.

\* Pictures recorded in the DV format are played back as SD (standard definition) images regardless of the connection.

## Jacks on your camcorder

Open the jack cover and connect the cable.

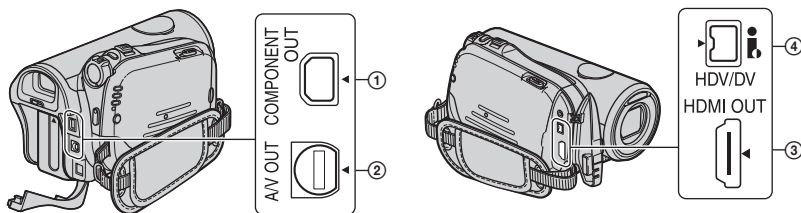

## Connecting to a high definition TV

: Signal flow

Type	Camcorder	Cable	TV	Menu Setting
------	-----------	-------	----	--------------

**A**



Component video cable (supplied)

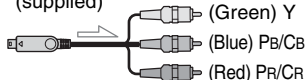

(STANDARD SET)  
[VCR HDV/DV] →  
[AUTO] (p. 61)  
[COMPONENT] →  
[1080i/576i] (p. 63)



A/V connecting cable (supplied)

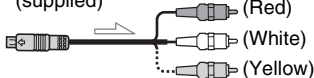

- An A/V connecting cable is also needed to output audio signals. Connect the white and red plugs of the A/V connecting cable to the audio input jack of your TV.

**B**



HDMI cable (optional)







(STANDARD SET)  
[VCR HDV/DV] →  
[AUTO] (p. 61)

- Use an HDMI cable with the HDMI logo.
- Pictures in the HDV format are not output from the HDMI OUT jack, if copyright protection signals are recorded in the pictures.
- DV format pictures input to the camcorder via i.LINK cable (p. 73) cannot be output.
- Your TVs may not function correctly (e.g., no sound or image). Do not connect the HDMI OUT jack of your camcorder and HDMI OUT jack of the external device with the HDMI cable. This may cause a malfunction.

## Playing the picture on a TV (Continued)

 : Signal flow

Type	Camcorder	Cable	TV	Menu Setting
	<b>C</b> 	i.LINK cable (optional) 	i.LINK 	 (STANDARD SET) [VCR HDV/DV] → [AUTO] (p. 61) [i.LINK CONV] → [OFF] (p. 64)

- Your TV needs to have an i.LINK jack compatible with HDV1080i. For details, confirm the specifications of your TV. For details on Sony HDV1080i compliant TVs, see page 109.
- If your TV is not compatible with HDV1080i, connect your camcorder and TV with the supplied component video cable and A/V connecting cable as illustrated in **A**.
- The TV needs to be set so that it recognizes that the camcorder is connected. See the instruction manuals supplied with your TV.







### Connecting to a 16:9 (wide) or 4:3 TV

#### To set the aspect ratio according to the connected TV (16:9/4:3)

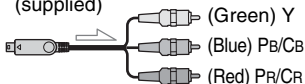
Change the [TV TYPE] setting to match your TV (p. 64).

- When you play back a tape recorded in the DV format on a 4:3 TV not compatible with the 16:9 signal, set **[WIDE SELECT]** to [4:3] on your camcorder when recording a picture (p. 62).

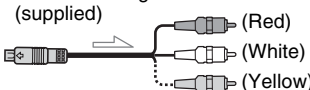
 : Signal flow

Type	Camcorder	Cable	TV	Menu Setting
	<b>D</b> 	Component video cable (supplied)  (Green) Y (Blue) PB/CB (Red) PR/CR	COMPONENT VIDEO IN 	 (STANDARD SET) [VCR HDV/DV] → [AUTO] (p. 61) [COMPONENT] → [576i] (p. 63) [TV TYPE] → [16:9]/[4:3]* (p. 64)
		A/V connecting cable (supplied)  (Red) (White) (Yellow)	AUDIO 	

- A/V connecting cable is also needed to output audio signals. Connect the white and red plugs of the A/V connecting cable to the audio input jack of your TV.



: Signal flow

Type	Camcorder	Cable	TV	Menu Setting
------	-----------	-------	----	--------------

**E**

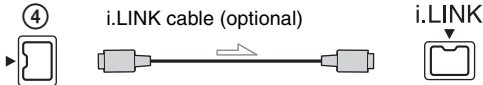

 (STANDARD SET)  
 [VCR HDV/DV] →  
 [AUTO] (p. 61)  
 [i.LINK CONV] →  
 [ON (HDV → DV)]  
 (p. 64)

- The TV needs to be set so that it recognizes that the camcorder is connected. See the instruction manuals supplied with your TV.

**F**

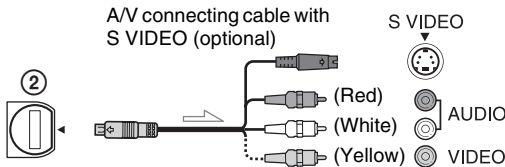

 (STANDARD SET)  
 [VCR HDV/DV] →  
 [AUTO] (p. 61)  
 [TV TYPE] →  
 [16:9]/[4:3]\* (p. 64)

- When connecting only an S VIDEO plug (S VIDEO channel), audio signals are not output. To output audio signals, connect the white and red plugs of the A/V connecting cable with an S VIDEO cable to the audio input jack of your TV.
- This connection produces higher resolution pictures compared with the A/V connecting cable (Type **G**).

**G**

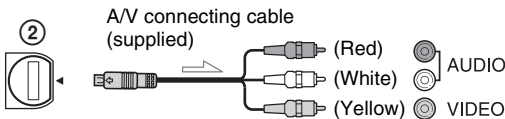

 (STANDARD SET)  
 [VCR HDV/DV] →  
 [AUTO] (p. 61)  
 [TV TYPE] →  
 [16:9]/[4:3]\* (p. 64)

- \* Change the settings according to the TV connected.
- If you connect your camcorder to your TV using more than one type of cable to output images from a jack other than the i.LINK jack, the order of priority of the output signals is as follows:  
 HDMI → component video → S VIDEO → audio/video.
- See page 113 for the details of i.LINK.

## Playing the picture on a TV (Continued)

### About HDMI (High Definition Multimedia Interface)

HDMI OUT jack is an interface to send both video/audio signals. Connecting HDMI OUT jack and external device supplies high quality images and digital audio to you.

### When connecting to your TV via a VCR

Select the connecting method on page 70 depending on the input jack of the VCR. Connect your camcorder to the LINE IN input on the VCR using the A/V connecting cable. Set the input selector on the VCR to LINE (VIDEO 1, VIDEO 2, etc.).

### When your TV is monaural (When your TV has only one audio input jack)

Connect the yellow plug of the A/V connecting cable to the video input jack and connect the white (left channel) or the red (right channel) plug to the audio input jack of your TV or VCR. When you want to play the sound in monaural mode, use a connecting cable for that purpose.

### If your TV/VCR has a 21-pin adaptor (EUROCONNECTOR)

Use a 21-pin adaptor (optional) to view playback pictures.

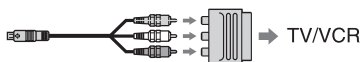



# Using the menu items

Follow the instructions below to use each of the menu items listed after this page.

## 1 Slide the POWER switch in the direction of the arrow repeatedly to turn on the respective lamp.

CAMERA-TAPE lamp:  settings on a tape

CAMERA-MEMORY lamp:  settings on a “Memory Stick Duo”

PLAY/EDIT lamp: settings for viewing/editing

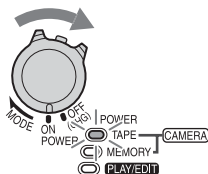

## 2 Touch the LCD screen to select the menu item.

Unavailable items will be grayed out.

### ■ To use the short-cuts of Personal Menu



On Personal Menu, short-cuts for frequently used menu items are added.

- You can customize Personal Menu as you like (p. 67).

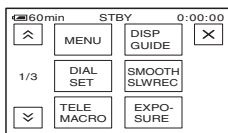
#### ① Touch .



#### ② Touch the desired item.

If the desired item is not displayed on the screen, touch / until the item is displayed.

#### ③ Select the desired setting, then touch .

### ■ To use menu items

You can customize menu items that are not added to Personal Menu.

#### ①

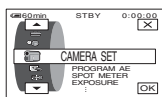

#### ②

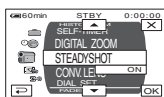

#### ③

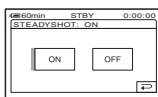

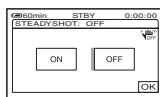

#### ④



#### ① Touch → .

The menu index screen appears.



#### ② Select the desired menu.

Touch / to select the item, then touch  (The process in step ③ is the same as that in step ②).

#### ③ Select the desired item.

- You can also touch the item directly to select it.

#### ④ Customize the item.

After finishing the settings, touch  →  (close) to hide the menu screen.

If you decide not to change the setting, touch  to return to the previous screen.

## ■ To use menu items during Easy Handycam operation

 is not displayed during Easy Handycam operation (p. 24).

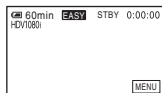



① Touch [MENU].

Available menu items appear on the screen.

② Select the desired menu.

③ Change your item setting.

After finishing the settings, touch .

If you decide not to change the setting, touch  to return to the previous screen.

- Cancel Easy Handycam operation to use menu items normally (p. 24).

---

• See page 68 for the settings of CAM CTRL dial.

# Menu items

Available menu items (●) vary depending on which lamp is lit. During Easy Handycam operation, the setting is set automatically as shown in the following list.

Position of lamp:

TAPE

MEMORY

PLAY/EDIT

Easy Handycam

## CAMERA SET menu (p. 48)









	TAPE	MEMORY	PLAY/EDIT	Easy Handycam
PROGRAM AE	●	●	–	AUTO
SPOT METER	●	●	–	–
EXPOSURE	●	●	–	AUTO
WHITE BAL.	●	●	–	AUTO
SHARPNESS	●	●	–	–
AUTO SHUTTER	●	–	–	ON
AE SHIFT	●	●	–	OFF
CAMERA COLOR	●	●	–	–
WB SHIFT	●	●	–	–
SPOT FOCUS	●	●	–	AUTO
FOCUS	●	●	–	AUTO
TELE MACRO	●	●	–	OFF
FLASH SET	●	●	–	⚡*/OFF
SUPER NS	●	–	–	OFF
NS LIGHT	●	●	–	ON
COLOR SLOW S	●	●	–	OFF
ZEBRA	●	●	–	OFF
HISTOGRAM	●	●	–	OFF
SELF-TIMER	●	●	–	●**
DIGITAL ZOOM	●	–	–	OFF
STEADYSHOT	●	–	–	ON
CONV.LENS	●	–	–	–*
DIAL SET	●	●	–	–

## MEMORY SET menu (p. 54)

	TAPE	MEMORY	PLAY/EDIT	Easy Handycam
STILL SET	–	●	●	FINE/●*
 ALL ERASE	–	–	●	●
 FORMAT	–	●	●	–
FILE NO.	–	●	●	–*
NEW FOLDER	–	●	●	–
REC FOLDER	–	●	●	–*
PB FOLDER	–	–	●	–*

## PICT.APPLI. menu (p. 57)

	TAPE	MEMORY	PLAY/EDIT	Easy Handycam
FADER	●	–	–	OFF
SLIDE SHOW	–	–	●	–
D.EFFECT	●	–	●	OFF
PICT.EFFECT	●	–	●	OFF
INT.REC-STL	–	●	–	OFF
SMTH SLW REC	●	–	–	–
PictBridge PRINT	–	–	●	–
USB SELECT	–	–	●	–

	Position of lamp:	TAPE	MEMORY	PLAY/EDIT	Easy Handycam
DEMO MODE	●	–	–	–	ON
 <b>EDIT/PLAY menu</b> (p. 60)					
 VAR. SPD PB	–	–	●	–	–
 REC CTRL	–	–	●	–	–
BURN DVD	–	–	●	–	–
END SEARCH	●	–	●	–	–
 <b>STANDARD SET menu</b> (p. 61)					
VCR HDV/DV	–	–	●	–	AUTO
REC FORMAT	●	–	–	–	●*
DV SET 	●	–	●	–	SP*/16:9 WIDE*/ J16b */-*
VOLUME	–	–	●	–	●*
MULTI-SOUND	–	–	●	–	STEREO
LCD/VF SET	●	●	●	–	– /NORMAL/ – / NORMAL
COMPONENT	●	●	●	–	1080i/576i*
i.LINK CONV	●	–	●	–	OFF*
TV TYPE	●	●	●	–	16:9*
DISP GUIDE	●	●	●	–	●
STATUS CHECK	●	–	●	–	–
GUIDEFAME	●	●	–	–	OFF
DATA CODE	–	–	●	–	●
 REMAINING	●	–	●	–	AUTO
REMOTE CTRL	●	●	●	–	ON
REC LAMP	●	●	–	–	ON
BEEP	●	●	●	–	●*
DISP OUTPUT	●	●	●	–	LCD PANEL
MENU ROTATE	●	●	●	–	NORMAL*
A.SHUT OFF	●	●	●	–	5min
CALIBRATION	–	–	●	–	–
QUICK REC  HDV1080i	●	–	–	–	OFF
 <b>TIME/LANGU. menu</b> (p. 66)					
CLOCK SET	●	●	●	–	●*
WORLD TIME	●	●	●	–	–*
LANGUAGE	●	●	●	–	–*

\* The setting value before entering Easy Handycam operation will be retained.

\*\* Cannot be operated in the CAMERA-TAPE mode.

# CAMERA SET menu

Settings to adjust your camcorder to the recording conditions (EXPOSURE/WHITE BAL./STEADYSHOT, etc.)

The default settings are marked with ►.  
The indicators in parentheses appear when the items are selected.

See page 44 for details on selecting menu items.

## PROGRAM AE

You can record pictures effectively in various situations with the [PROGRAM AE] function.

### ► AUTO

Select to automatically record pictures effectively without the [PROGRAM AE] function.

### SPOTLIGHT\* (☹)

Select to prevent people's faces from appearing excessively white when subjects are lit by strong light.



### PORTRAIT (Soft portrait) (☺)



Select to bring out the subject such as people or flowers while creating a soft background.

### BEACH&SKI\* (☀)



Select to prevent people's faces from appearing dark in strong light or reflected light, such as at a beach in midsummer or on a ski slope.

### SUNSET&MOON\*\* (☾)



Select to maintain the atmosphere of situations such as sunsets, general night views or fireworks.

### LANDSCAPE\*\* (▲)



Select to shoot distant subjects clearly. This setting also prevents your camcorder from focusing on glass or metal mesh in windows that comes in between the camcorder and the subject.

- Items with one asterisk (\*) are adjusted to focus on subjects only a short distance away. Items with two asterisks (\*\*) are adjusted to focus on subjects farther away.
- The setting returns to [AUTO] when you set the POWER switch to OFF (CHG) for more than 12 hours.

## SPOT METER (Flexible spot meter)

You can adjust and fix the exposure to the subject, so that it is recorded in suitable brightness even when there is strong contrast between the subject and the background, such as subjects in the spotlight on stage.

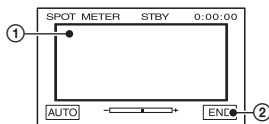

- ① Touch the point where you want to fix and adjust the exposure on the screen.  
← → appears.
- ② Touch [END].

To return the setting to automatic exposure, touch [AUTO] → [END].

- If you set [SPOT METER], [EXPOSURE] is automatically set to [MANUAL].



- The setting returns to [AUTO] when you set the POWER switch to OFF (CHG) for more than 12 hours.

## EXPOSURE

You can fix the brightness of a picture manually. When recording indoors on a clear day, for instance, you can avoid backlight shadows on people next to the window by fixing the exposure to that of the wall side of the room.

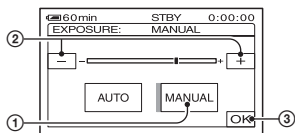

- 1 Touch [MANUAL].  
— appears.
- 2 Adjust the exposure by touching [−]/[+].
- 3 Touch [OK].

To return the setting to automatic exposure, touch [AUTO] → [OK].

- You can also adjust the setting manually using the CAM CTRL dial (p. 68).
- The setting returns to [AUTO] when you set the POWER switch to OFF (CHG) for more than 12 hours.

## WHITE BAL. (White balance)

You can adjust the color balance to the brightness of the recording environment.

### ► AUTO

The white balance is adjusted automatically.

### OUTDOOR (☀)

The white balance is adjusted to be appropriate for the following recording conditions:

- Outdoors
- Night views, neon signs and fireworks
- Sunrise or sunset
- Under daylight fluorescent lamps

### INDOOR (☾)

The white balance is adjusted to be appropriate for the following recording conditions:

- Indoors
- At party scenes or studios where the lighting conditions change quickly
- Under video lamps in a studio, or under sodium lamps or incandescent-like color lamps

### ONE PUSH (📺)



The white balance will be adjusted according to the ambient light.

- 1 Touch [ONE PUSH].
- 2 Frame a white object such as a piece of paper, to fill the screen under the same lighting conditions as you will shoot the subject.
- 3 Touch [📺].

- 📺 flashes quickly. When the white balance has been adjusted and stored in the memory, the indicator stops flashing.
- Do not shake your camcorder while 📺 is flashing quickly.
- 📺 flashes slowly if white balance could not be set.
- If 📺 keeps flashing even after you have touched [OK], set [WHITE BAL.] to [AUTO].

- If you have changed the battery pack while [AUTO] is selected, taken your camcorder outdoors or brought it indoors after outside use while using fixed exposure, select [AUTO] and aim your camcorder at a nearby white object for about 10 seconds for better color balance adjustment.
- Redo the [ONE PUSH] procedure if you change the [PROGRAM AE] settings, or bring your camcorder outdoors from inside the house, or vice versa.
- Set [WHITE BAL.] to [AUTO] or [ONE PUSH] under white or cool white fluorescent lamps.
- The setting returns to [AUTO] when you set the POWER switch to OFF (CHG) for more than 12 hours.



sharpen the focus.  appears when the focus cannot be adjusted any closer, and  appears when the focus cannot be adjusted farther away.

③ Touch .

To adjust the focus automatically, touch [AUTO] →  in step ①.

- It is easier to focus on the subject by moving the power zoom lever towards T (telephoto) to adjust the focus, then towards W (wide angle) to adjust the zoom for recording. When you want to record a subject at close range, move the power zoom lever to W (wide angle), then adjust the focus.
- The minimum possible distance between camcorder and subject while maintaining sharp focus is about 1 cm (about 13/32 in.) for wide angle and about 80 cm (about 2 5/8 feet) for telephoto.
- The setting returns to [AUTO] when you set the POWER switch to OFF (CHG) for more than 12 hours.
- You can also adjust the focus manually using the CAM CTRL dial (p. 68).

## TELE MACRO

This is useful to shoot small subjects, such as flowers or insects. You can blur out backgrounds and the subject stands out clearer.

When you set [TELE MACRO] to [ON] () , the zoom (p. 28) moves to the top of the T (Telephoto) side automatically and allows for recording subjects at a close distance, down to about 37 cm (14 5/8 in.).



To cancel, touch [OFF], or zoom to wide-angle (W side).

- When recording a distant subject, focusing may be difficult and can take some time.
- Adjust the focus manually ([FOCUS], p. 50) when it is hard to focus automatically.

## FLASH SET

You can set this function when you use the built-in flash or an external flash (optional) that is compatible with your camcorder.

### ■ FLASH LEVEL

#### HIGH(⚡+)

Makes the flash level higher.

#### ▶ NORMAL(⚡)

#### LOW(⚡-)

Makes the flash level lower.



### ■ REDEYE REDUC

You can prevent redden by activating the flash before recording.

Set [REDEYE REDUC] to [ON], then press  (flash) (p. 29) repeatedly to select a setting.

 (Auto reeye reduction): Pre-flashes to reduce redden before the flash automatically flashes when there is insufficient ambient light.



  (Forced reeye reduction): Always uses the flash and the redden reducing pre-flash.



 (No flash): Records without flash.

- The redden reduction may not produce the desired effect due to individual differences and other conditions.

## SUPER NS (Super NightShot)

The picture will be recorded at a maximum of 16 times the sensitivity of NightShot recording if you set [SUPER NS] to [ON] while the NIGHTSHOT switch (p. 29) is also set to ON.

 and ["SUPER NIGHTSHOT"] appear on the screen.

To return to the normal setting, set [SUPER NS] to [OFF], or set the NIGHTSHOT switch to OFF.

## CAMERA SET menu (Continued)

- Do not use NightShot/[SUPER NS] in bright places. This may cause a malfunction.
- Do not cover the infrared port with your fingers or other objects (p. 29).
- Remove the conversion lens (optional).
- Adjust the focus manually ([FOCUS], p. 50) when it is hard to focus automatically.
- The shutter speed of your camcorder changes depending on the brightness. The motion of the picture may slow down in this case.

### NS LIGHT (NightShot Light)

When using either the NightShot (p. 29) or [SUPER NS] (p. 51) function to record, you can record clearer pictures by setting [NS LIGHT], which emits infrared light (invisible), to [ON] (the default setting).

- Do not cover the infrared port with your fingers or other objects (p. 29).
- Remove the conversion lens (optional).
- The maximum shooting distance using [NS LIGHT] is about 3 m (10 feet).

### COLOR SLOW S (Color Slow Shutter)

When you set [COLOR SLOW S] to [ON], you can record an image brighter in color even in dark places.

 and [COLOR SLOW SHUTTER] appear on the screen.

To cancel [COLOR SLOW S], touch [OFF].

- Adjust the focus manually ([FOCUS], p. 50) when it is hard to focus automatically.
- The shutter speed of your camcorder changes depending on the brightness. The motion of the picture may slow down at this time.

### ZEBRA

Diagonal stripes appear in portions of the screen where brightness is at a preset level. This is useful as a guide when adjusting the brightness. When you change the default setting,  is displayed. The zebra pattern is not recorded.

### ▶ OFF

The zebra pattern is not displayed.

### 70

The zebra pattern appears at a screen brightness level of about 70 IRE.

### 100

The zebra pattern appears at a screen brightness level of about 100 IRE or higher.

- Portions of the screen where brightness is about 100 IRE or above may appear overexposed.
- IRE represents the screen brightness.

### HISTOGRAM

When you set [HISTOGRAM] to [ON], the [HISTOGRAM] (a graph to display a distribution of tones in your picture) window appears on the screen. This item is useful when you adjust exposure. You can adjust the [EXPOSURE] or [AE SHIFT] checking the [HISTOGRAM] window. The [HISTOGRAM] will not be recorded on a tape or “Memory Stick Duo.”

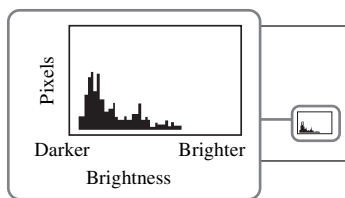

- The left area on the graph shows the darker areas of the picture while the right area shows the brighter areas.

### SELF-TIMER

The self-timer starts recording after about 10 seconds.

Press START/STOP to record movies, or PHOTO to record still images when [SELF-TIMER] is set to [ON] and  appears.

To cancel the count down, touch [RESET].

To cancel the self-timer, select [OFF].

- You can also operate by pressing START/STOP or PHOTO on the Remote Commander (p. 36).

## DIGITAL ZOOM

You can select the maximum zoom level in case you want to zoom to a level greater than 10 × (the default setting) while recording on a tape. Note that the image quality decreases when you are using the digital zoom.

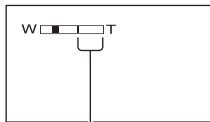

The right side of the bar shows the digital zooming factor. The zooming zone appears when you select the zooming level.

### ► OFF

Up to 10 × zoom is performed optically.

### 20 ×

Up to 10 × zoom is performed optically, and after that, up to 20 × zoom is performed digitally.

### 80 ×

Up to 10 × zoom is performed optically, and after that, up to 80 × zoom is performed digitally.

## STEADYSHOT

You can compensate for camera shake (the default setting is [ON]). Set [STEADYSHOT] to [OFF] (  ) when using a tripod (optional), then the image becomes natural.

## CONV.LENS

When using an optional conversion lens, use this function to record using the optimum compensation for camera shake for each lens.

### ► OFF

Select this when the conversion lens (optional) is not used.

### WIDE CONV. ( )

Select this to use the wide conversion lens (optional).

### TELE CONV. ( )

Select this to use the tele conversion lens (optional).

## DIAL SET

You can assign an item you want to set to the CAM CTRL dial and adjust it manually using the CAM CTRL dial.

### ► FOCUS

Assigns the [FOCUS] (p. 50) setting to the CAM CTRL dial.

### EXPOSURE

Assigns the [EXPOSURE] (p. 49) setting to the CAM CTRL dial.

### AE SHIFT

Assigns the [AE SHIFT] (p. 50) setting to the CAM CTRL dial.

### WB SHIFT

Assigns the [WB SHIFT] (p. 50) setting to the CAM CTRL dial.

- See page 68 for details on the CAM CTRL dial.

# MEMORY SET menu

Settings for the “Memory Stick Duo”  
(QUALITY/IMAGE SIZE/ALL ERASE/NEW  
FOLDER, etc.)

The default settings are marked with ►.  
The indicators in parentheses appear when  
the items are selected.

See page 44 for details on selecting  
menu items.

## STILL SET

### QUALITY

#### ► FINE (FINE)

Records still images at the fine image  
quality level.

#### STANDARD (STD)

Records still images at the standard image  
quality level.

- Image quality is automatically fixed to [FINE]  
during Easy Handycam operation.

### IMAGE SIZE

#### ► 4.0M (4.0M)

Records still images clearly.

#### 3.0M (3.0M)

Records still images clearly in the 16:9  
(wide) ratio.

#### 1.9M (1.9M)

Allows you to record more still images in  
relatively clear quality.

#### VGA (0.3M) (VGA)

Allows for the maximum number of  
images to be recorded.

- [IMAGE SIZE] can be set only when the  
POWER switch is set to CAMERA-MEMORY.

## Capacity of the “Memory Stick Duo” (MB) and the number of recordable pictures



When the POWER switch is set to CAMERA-  
MEMORY



	4.0M 2304 × 1728 4.0M	3.0M 2304 × 1296 3.0M	1.9M 1600 × 1200 1.9M	VGA 640 × 480 LVGA
16MB	7 18	10 24	16 37	96 240
32MB	15 37	20 48	32 75	190 485
64MB	31 75	41 98	65 150	390 980
128MB	63 150	83 195	130 300	780 1970
256MB	110 270	150 355	235 540	1400 3550
512MB	230 550	305 720	480 1100	2850 7200
1GB	475 1100	620 1450	980 2250	5900 14500
2GB	970 2300	1250 3000	2000 4650	12000 30000

- All numbers measured at the following setting:  
Top: [FINE] is selected for image quality.  
Bottom: [STANDARD] is selected for image  
quality.
- When using the “Memory Stick Duo” made by  
Sony Corporation. The number of recordable  
pictures varies depending on the recording  
environment.

When the POWER switch is set to CAMERA-  
TAPE\*



	2.3M 2016 × 1134 2.3M	1.7M 1512 × 1134 1.7M
16MB	13 32	17 40
32MB	27 65	36 85



	2.3M 2016 × 1134 	1.7M 1512 × 1134 
64MB	54 130	72 170
128MB	105 260	145 340
256MB	195 470	260 590
512MB	400 960	530 1200
1GB	820 1950	1050 2450
2GB	1650 4000	1800 4300



\*  [IMAGE SIZE] is fixed to  2.3M] in HDV or DV format (16:9) and [1.7M] in DV format (4:3).

- All numbers measured at the following setting:  
Top: [FINE] is selected for image quality.  
Bottom: [STANDARD] is selected for image quality.
- When using the “Memory Stick Duo” made by Sony Corporation. The number of recordable pictures varies depending on the recording environment.

### When the POWER switch is set to PLAY/ EDIT\*

	1.2M 1440 × 810 	VGA 640 × 480 	0.2M 640 × 360 
16MB	25 60	96 240	115 240
32MB	51 120	190 485	240 485
64MB	100 240	390 980	490 980
128MB	205 490	780 1970	980 1970
256MB	370 890	1400 3550	1750 3550
512MB	760 1800	2850 7200	3600 7200

	1.2M 1440 × 810 	VGA 640 × 480 	0.2M 640 × 360 
1GB	1550 3650	5900 14500	7300 14500
2GB	3150 7500	12000 30000	15000 30000

\*  [IMAGE SIZE] is fixed to  1.2M] in HDV format,  0.2M] in DV format (16:9) and [VGA (0.3M)] in DV format (4:3).

- All numbers measured at the following setting:  
Top: [FINE] is selected for image quality.  
Bottom: [STANDARD] is selected for image quality.
- When using the “Memory Stick Duo” made by Sony Corporation. The number of recordable pictures varies depending on the recording environment.

### Approximate data size of a picture (kB)

#### 4:3 picture

4.0M	1.9M	1.7M	VGA
1980 830	960 420	860 370	150 60

#### 16:9 picture

3.0M	2.3M	1.2M	0.2M
1500 640	1150 480	610 260	130 60

- Data sizes measured at the following settings:  
Top: [FINE] is selected for image quality.  
Bottom: [STANDARD] is selected for image quality.

### ALL ERASE

Deletes all the pictures on a “Memory Stick Duo” without image protection, or in the selected folder.

- ① Select [ALL FILES] or [CURRNT FOLDER].

**[ALL FILES]:** Deletes all the images on the “Memory Stick Duo.”

## MEMORY SET menu (Continued)

**[CURRNT FOLDER]:** Deletes all the images in the selected folder.

② Touch [YES] twice → [X].

- Cancel image protection on the “Memory Stick Duo” beforehand when using the “Memory Stick Duo” with the write-protect tab (p. 110).
- The folder will not be deleted even when you delete all the pictures in the folder.
- Do not do any of the following while [Erasing all data...] is displayed:
  - Operate the POWER switch/operation buttons.
  - Eject the “Memory Stick Duo.”

### FORMAT

The “Memory Stick Duo” has been formatted at the factory, and does not require formatting.

To execute formatting, touch [YES] twice → [X].

Formatting is completed, and all the images will be deleted.

- Do not do any of the following while [Formatting...] is displayed:
  - Operate the POWER switch/operation buttons.
  - Eject the “Memory Stick Duo.”
- Formatting erases everything on the “Memory Stick Duo” including protected image data and newly created folders.

### FILE NO.

#### ► SERIES

Assigns file numbers in sequence even if the “Memory Stick Duo” is replaced with another one. The file number is reset when a new folder is created or the recording folder is replaced with another.

#### RESET

Resets the file number to 0001 each time the “Memory Stick Duo” is changed.

### NEW FOLDER

You can create a new folder (102MSDCF to 999MSDCF) on a “Memory Stick Duo.” When a folder is full (a maximum of 9,999 images are stored) a new folder is automatically created.

Touch [YES] → [X].

- You cannot delete the created folders using your camcorder. You will have to format the “Memory Stick Duo” (p. 56), or delete them using your computer.
- The number of recordable pictures on a “Memory Stick Duo” may decrease as the number of folders increases.

### REC FOLDER (Recording folder)

Select the folder to be used for recording with [▲]/[▼], then touch [OK].

- As the default setting, pictures are saved in the 101MSDCF folder.
- Once you record a picture in a folder, the same folder will be set as the default folder for playback.

### PB FOLDER (Playback folder)

Select the playback folder with [▲]/[▼], then touch [OK].



# PICT.APPLI. menu

Special effects on pictures or additional functions on recording/playback (SLIDE SHOW/PICT.EFFECT/SMTH SLW REC, etc.)

The default settings are marked with ►. The indicators in parentheses appear when the items are selected.

See page 44 for details on selecting menu items.

## FADER

You can record a transition with the following effects adding to the interval between scenes.

- ① Select the desired effect in [STBY] (during fading in) or [REC] (during fading out) mode, then touch [OK].
- ② Press START/STOP.  
The fader indicator stops flashing and disappears when the fade is complete.

To cancel before starting the operation, touch [OFF] in step ①. Once you press START/STOP, the setting is canceled.



## WHITE FADER



## BLACK FADER



## MOSAIC FADER



## MONOTONE

When fading in, the picture gradually changes from black and white to color. When fading out, it gradually changes from color to black and white.

## SLIDE SHOW

Plays back the images stored on a “Memory Stick Duo,” or in a folder in sequence (slide show).

- ① Touch [SET] → [PB FOLDER].
- ② Select [ALL FILES (all)] or [CURRNT FOLDER (T)], then touch [OK].  
If you select [CURRNT FOLDER (T)], all the images in the current playback folder selected in [PB FOLDER] (p. 56) are played back in sequence.
- ③ Touch [REPEAT].
- ④ Select [ON] or [OFF], then [OK].  
To repeat the slide show, select [ON] (↻).  
To execute the slide show only once, select [OFF].
- ⑤ Touch [END] → [START].

To cancel [SLIDE SHOW], touch [END]. To pause, touch [PAUSE].

- You can select the first picture for the slide show with [−]/[+] before touching [START].

## D.EFFECT (Digital effect)

You can add digital effects to your recordings.

- ① Touch the desired effect.  
When you select [STILL], the image is saved as a still image.
- ② Adjust the effect with [−]/[+], then touch [OK].

Effect	Items to adjust
CINEMA EFFECT*	No adjustment necessary.
STILL	The degree of transparency of the still image you want to superimpose under a movie.

Effect	Items to adjust
FLASH	The interval of frame-by-frame playback.
TRAIL	The fade time of the incidental image.
SLOW SHUTTR*	Shutter speed (1 is 1/25, 2 is 1/12, 3 is 1/6, 4 is 1/3).
OLD MOVIE*	No adjustment necessary.

\* Available during tape recording only.

- ③ Touch [OK].  
 appears.

To cancel [D.EFFECT], touch [OFF] in step ①.

► **OFF**

Does not use [D.EFFECT] setting.

**CINEMA EFFECT (Cinematic effect)**

You can add a cinematic atmosphere to pictures by adjusting the image quality.

**STILL**

Records a movie while superimposing it on a previously recorded still image.



**FLASH (flash motion)**

Records a movie with a serial-still-image effect (strobe effect).

**TRAIL**

Records a picture so that an incidental image like a trail is left.



**SLOW SHUTTR (slow shutter)**

The shutter speed is slowed down. Suitable for shooting a subject more clearly in a dark place.

- Adjust the focus manually using a tripod (optional) since adjusting the focus automatically is hard when [SLOW SHUTTR] is selected. ([FOCUS], p. 50)

**OLD MOVIE**

Adds an old movie effect with a sepia hue to pictures.

- You cannot change to another digital effect while recording pictures on a tape with [CINEMA EFFECT] selected.
- You cannot record playback pictures edited using special effects on the tape in your camcorder.
- You cannot add effects to externally input pictures. Also, you cannot output playback pictures edited with digital effects via the  HDV/DV Interface (i.LINK).
- You can save pictures edited using special effects on a “Memory Stick Duo” (p. 75) or record them on another VCR/DVD device, etc. (p. 70).
- While using [D.EFFECT], you cannot use the review button for still images on the “Memory Stick Duo” .

**PICT.EFFECT (Picture effect)**

You can add special effects to a picture during recording or playback.  appears.

► **OFF**

Does not use [PICT.EFFECT] setting.

**SKINTONE\***

Makes skin texture look more smoother and more appealing.

**NEG.ART**



The color and brightness are reversed.

**SEPIA**

Pictures appear in sepia.

**B&W**

Pictures appear in black and white.

**SOLARIZE**



Pictures appear as an illustration with strong contrast.

## PASTEL\*



Pictures appear as a pale pastel drawing.

## MOSAIC\*



Pictures appear mosaic-patterned.

\* Available during tape recording only.

- You cannot add effects to externally input pictures. The playback pictures edited with picture effects are output via the  HDV/DV Interface (i.LINK) without effect control.
- You can save pictures edited using special effects on a "Memory Stick Duo" (p. 75) or record them on another VCR/DVD device, etc. (p. 70).

## INT.REC-STL (Interval photo recording)

You can record still images on the "Memory Stick Duo" at a selected interval. This function is useful to observe the movement of clouds or the changes in daylight, etc.

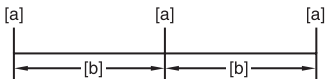

**[a]:** Recording

**[b]:** Interval

- ① Touch **[SET]** → a desired interval time (1, 5 or 10 minutes) → **[OK]** → **[ON]** → **[OK]** → **[X]**.
- ② Press **PHOTO** fully.  
 stops flashing and the interval still image recording starts.

To cancel **[INT.REC-STL]**, select **[OFF]** in step ①.

## SMTH SLW REC (Smooth slow recording)

Fast moving subjects and actions, which cannot be captured under the general shooting conditions, can be shot in smooth moving slow-motion for about 3 seconds. This is useful to shoot fast actions such as a golf or tennis swing.

Press **START/STOP** on the **[SMTH SLW REC]** screen.

An about 3 second movie is recorded as a 12 second slow-motion movie.

When **[Recording...]** disappears, recording is finished.

Touch **[SET]** to select one of the following start points for recording before pressing **START/STOP**.

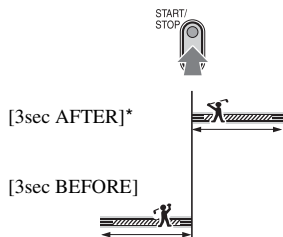

\* The default setting is [3sec AFTER].

- Sounds cannot be recorded.

To cancel **[SMTH SLW REC]**, select **[END]**.

## PictBridge PRINT

See page 77.

## USB SELECT

You can connect the camcorder to a personal computer with a USB cable and view pictures on the computer. You can also connect the camcorder to a PictBridge compatible printer (p. 77) using this function.

▶  **Memory Stick**

Select this to view pictures on a “Memory Stick Duo” on the computer or to import them to the computer.

**PictBridge PRINT**

Select this when you connect the camcorder to a PictBridge compatible printer to print out directly (p. 77).

**DEMO MODE**

The default setting is [ON], allowing you to view the demonstration in about 10 minutes, after you have removed both a cassette and a “Memory Stick Duo” from your camcorder, and slide the POWER switch to turn on the CAMERA-TAPE lamp.

- The demonstration will be suspended in situations such as those described below.
  - When you touch the screen during the demonstration (The demonstration starts again after about 10 minutes).
  - When a cassette or a “Memory Stick Duo” is inserted.
  - When the POWER switch is set to other than CAMERA-TAPE.

**Settings for editing or playing back in various modes (VAR.SPD PB/END SEARCH, etc.)**







The default settings are marked with ▶. The indicators in parentheses appear when the items are selected.

**See page 44 for details on selecting menu items.**

 **VAR.SPD PB**  
**(Various speed playback)**

You can play back in various modes while viewing movies.

- ① Touch the following buttons during playback.

To	Touch
change the playback direction*	 (frame)
play back slowly**	 To reverse direction:  (frame) → 
play back frame by frame	 (frame) during playback pause. To reverse direction:  (frame) during frame playback.

\* Horizontal lines may appear at the top, bottom, or in the center of the screen. This is not a malfunction.

\*\* Pictures output from the  HDV/DV Interface (i.LINK) cannot be played back smoothly in slow mode.

- ② Touch  → .

To return to the normal playback mode, touch  (Play/Pause) twice (once from frame playback).

- You will not hear the recorded sound. You may see mosaic-like images of the previously played picture.
- Pictures in the HDV format are not output from the  HDV/DV Interface (i.LINK) when they



# STANDARD SET

## menu

are paused or played back in any mode other than normal playback mode.

- Pictures in the HDV format may appear distorted during:
  - Picture search
  - Reverse playback
- Playing back slowly to the reverse direction and playing back frame by frame to the reverse direction are not available in HDV1080i format.

### REC CTRL (Movie recording control)

See page 74.

### BURN DVD

When your camcorder is connected to a Sony VAIO series personal computer, you can easily burn the picture recorded on the tape on a DVD (Direct Access to “Click to DVD”) (p. 85).

- The quality of the picture to be copied to DVDs is SD (standard definition).

### END SEARCH

#### EXEC

The most recently recorded picture is played back for about 5 seconds and then stops automatically.

#### CANCEL

Stops [END SEARCH].

- [END SEARCH] will not work once you eject the cassette after you have recorded on the tape.

### Settings while recording on a tape or other basic settings (REC MODE/MULTI-SOUND/LCD/VF SET/DISP OUTPUT/QUICK REC, etc.)

The default settings are marked with ►. The indicators in parentheses appear when the items are selected.

See page 44 for details on selecting menu items.

### VCR HDV/DV

Select the playback signal. Normally select [AUTO].

When your camcorder is connected to another device using an i.LINK cable, select the signal to input/output from the  HDV/DV Interface (i.LINK). The selected signal is recorded or played back.

#### ► AUTO

Switches the signals between HDV and DV format automatically when playing back a tape.

During i.LINK connection, switches the signals between HDV and DV formats automatically, and inputs/outputs from the  HDV/DV Interface (i.LINK).

#### HDV

Plays back only the portions recorded in HDV format.

During i.LINK connection, inputs/outputs only HDV formatted signals from the  HDV/DV Interface (i.LINK), and records/plays back. You can also select this when connecting the camcorder to a computer, etc.

#### DV

Plays back only the portions recorded in DV format.

During i.LINK connection, inputs/outputs only DV formatted signals from the  HDV/DV Interface (i.LINK), and records/plays back. You can also select this when connecting the camcorder to a computer, etc.

- Disconnect the i.LINK cable before changing the [VCR HDV/DV] setting. Otherwise, the connected device, such as a VCR, may not be able to recognize the video signal from your camcorder.
- When [AUTO] is selected, when the signal switches between HDV and DV formats, the picture and sound are interrupted temporarily.
- When [i.LINK CONV] is set to [ON (HDV → DV)], pictures are output as follows:
  - at [AUTO], an HDV signal is converted to the DV format and output; a DV signal is output as it is.
  - at [HDV], an HDV signal is converted to the DV format and output; a DV signal is not output.
  - at [DV], a DV signal is output as it is; an HDV signal is not output.

## REC FORMAT

You can select a recording format.

### ▶ HDV1080i (HDV1080i)

Records in the HDV1080i specification.

### DV (DV)

Records in the DV format.

- When you output the recording picture using an i.LINK cable, set [i.LINK CONV] accordingly.

## DV SET DV

The following functions are available when recording in DV format.

### ■ [V] REC MODE (Recording mode)

#### ▶ SP (SP)

Records in the SP (Standard Play) mode on a cassette.

#### LP (LP)

Increases the recording time to 1.5 times the SP mode (Long Play).

- If you record in the LP mode, a mosaic-like noise may appear or sound may be interrupted when you play back the tape on other camcorders or VCRs.
- When you mix recordings in the SP mode and in the LP mode on one tape, the playback picture

may be distorted or the time code may not be written properly between the scenes.

### ■ [V] WIDE SELECT

You can select the aspect ratio according to the TV connected when recording. Refer also to the instruction manuals supplied with your TV.

#### ▶ 16:9 WIDE

Records pictures to the full screen on a 16:9 (wide) TV screen.

#### 4:3 (4:3)

Records pictures to the full screen on a 4:3 TV screen.

- Set [TV TYPE] correctly according to the TV connected for playback (p. 64).

### ■ [V] AUDIO MODE

#### ▶ 12BIT

Records in the 12-bit mode (2 stereo sounds).

#### 16BIT (16b)

Records in the 16-bit mode (1 stereo sound with high quality).

- When recording in the HDV format, sound is automatically recorded in [16BIT] mode.

### ■ [V] AUDIO MIX

You can monitor the sound recorded with audio dubbing or 4ch microphone recording on the tape during playback.

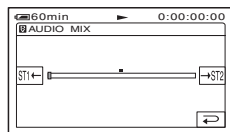

Touch [ST1+]/[ST2] to adjust the balance of the original sound (ST1) and the sound recorded afterwards (ST2), then touch [OK].

- The original sound (ST1) is output at the default setting.
- The adjusted audio balance returns to the default setting when you set the POWER switch to OFF (CHG) for more than 12 hours.

## VOLUME

Touch / to adjust the volume (p. 27).

- You can also adjust the setting using the CAM CTRL dial (p. 68).

## MULTI-SOUND

You can select whether to play back audio recorded using other devices with dual sound or stereo sound.

### ► STEREO

Plays back with main and sub sound (or stereo sound).

1

Plays back with main sound (or the left channel sound).

2

Plays back with sub sound (or the right channel sound).

- You can play back, but cannot record a dual sound track cassette on your camcorder.
- The setting returns to [STEREO] when you set the POWER switch to OFF (CHG) for more than 12 hours.

## LCD/VF SET

The recorded picture will not be affected by this operation.

### ■ LCD BRIGHT

You can adjust the brightness of the LCD screen.

- ① Adjust the brightness with / .
- ② Touch .

- You can also turn off the LCD backlight (p. 16).

### ■ LCD BL LEVEL

You can adjust the brightness of the LCD screen's backlight.

### ► NORMAL

Standard brightness.

### BRIGHT

Brightens the LCD screen.

- When you connect your camcorder to outside power sources, [BRIGHT] is automatically selected for the setting.
- When you select [BRIGHT], battery life is slightly reduced during recording.

### ■ LCD COLOR

You can adjust the color on the LCD screen with / .



Low intensity

High intensity

### ■ VF B.LIGHT

You can adjust the brightness of the viewfinder.

### ► NORMAL

Standard brightness.

### BRIGHT

Brightens the viewfinder screen.

- When you connect your camcorder to outside power sources, [BRIGHT] is automatically selected for the setting.
- When you select [BRIGHT], battery life is slightly reduced during recording.

## COMPONENT

Select [COMPONENT] when connecting your camcorder to a TV with the component input jack.

### 576i

Select when connecting your camcorder to a TV with the component input jack.

### ► 1080i/576i

Select when connecting your camcorder to a TV that has the component input jack and is capable of displaying the 1080i signal.

## i.LINK CONV

Signals in HDV format are converted to DV format, and pictures are output in DV format from the **i** HDV/DV Interface (i.LINK).

### ▶ OFF

Outputs the pictures from the **i** HDV/DV Interface (i.LINK) in accordance with the settings in [REC FORMAT] and [VCR HDV/DV].

### ON (HDV → DV)

Pictures in HDV format are converted to DV format, and pictures in DV format are output in DV format.

- For input signal via an i.LINK connection, see [VCR HDV/DV] (p. 61).
- Disconnect the i.LINK cable before setting [i.LINK CONV]. Otherwise, the connected video device may not be able to recognize the video signal from your camcorder.

## TV TYPE

You need to convert the signal depending on the TV connected when playing back the picture. The recorded pictures are played back as following illustrations.

### ▶ 16:9

Select to view your pictures on a 16:9 (wide) TV.

HDV/DV (16:9)  
format pictures



DV (4:3) format  
pictures



### 4:3

Select to view your pictures on a 4:3 standard TV.

HDV/DV (16:9)  
format pictures



DV (4:3) format  
pictures



- When you connect your camcorder to a TV with an i.LINK cable to play back the tape, [TV TYPE] cannot be set.

## DISP GUIDE

See page 17.

## STATUS CHECK

You can check the setup value of the following items.

- [COMPONENT] (p. 63)
- [i.LINK CONV] (p. 64)
- [TV TYPE] (p. 64)
- HDMI OUTPUT (p. 79)
- [VCR HDV/DV] (when the POWER switch is set to PLAY/EDIT) (p. 61)

## GUIDEFAME

You can display the frame and check that the subject is horizontal or vertical by setting [GUIDEFAME] to [ON]. The frame is not recorded. Press DISP/BATT INFO to make the frame disappear.

- Pointing the subject at the cross point of the guide frame makes a balanced composition.

## DATA CODE

During playback, displays the information (data code) recorded automatically at the time of recording.

### ▶ OFF

Data code is not displayed.



## DATE/TIME

Displays the date and time.

## CAMERA DATA (below)

Displays camera setting data.

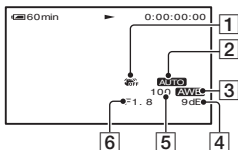

- 1 SteadyShot off
- 2 Exposure
- 3 White balance
- 4 Gain
- 5 Shutter speed
- 6 Aperture value

- The exposure adjustment value (0EV), a shutter speed, and the aperture value appear when still images on a "Memory Stick Duo" are played back.
- appears for a picture recorded using a flash.
- In the DATE/TIME data display, the date and time are displayed in the same area. If you record a picture without setting the clock, [-- --] and [--:--:--] will appear.
- During Easy Handycam operation, you can set only [DATE/TIME].

## REMAINING

### ▶ AUTO

Displays the remaining tape indicator for about 8 seconds in situations such as those described below.

- When you set the POWER switch to PLAY/EDIT or CAMERA-TAPE with a cassette inserted.
- When you touch (Play/Pause).

### ON

Always displays the remaining tape indicator.

## REMOTE CTRL (Remote control)

The default setting is [ON], allowing you to use the supplied Remote Commander (p. 36).

- Set to [OFF] to prevent your camcorder from responding to a command sent by another VCR remote control unit.

## REC LAMP (Recording lamp)

The camera recording lamp will not light up during recording when you set this to [OFF]. (The default setting is [ON].)

## BEEP

### ▶ ON

A melody sounds when you start/stop recording, or operate the touch panel.

### OFF

Cancels the melody.

## DISP OUTPUT

### ▶ LCD PANEL

Shows displays such as the time code on the LCD screen and in the viewfinder.

### V-OUT/PANEL

Shows displays such as the time code on the TV screen, LCD screen, and in the viewfinder.

## MENU ROTATE

### ▶ NORMAL

Scrolls the menu items downwards by touching .

### OPPOSITE

Scrolls the menu items upwards by touching .

### A.SHUT OFF (Auto shut off)

#### ► 5 min

The camcorder is automatically turned off when you do not operate your camcorder for more than approximately 5 minutes.

#### NEVER

The camcorder is not automatically turned off.

- When you connect your camcorder to a wall socket, [A.SHUT OFF] is automatically set to [NEVER].

### CALIBRATION

See page 116.

### QUICK REC

You can slightly reduce the recording start point time when resuming recording by turning the POWER switch from OFF (CHG) to on.

#### ► OFF

Takes more time to reach the recording start point, but a smooth transition can be recorded.

#### ON ()

Slightly reduces the recording start point time by turning the POWER switch from OFF (CHG) to on. Select this so you will not miss any time from the click of the shutter.

- If [QUICK REC] is set to [ON], the interval between scenes freezes for a moment (editing on your computer is recommended).
- If the recording standby mode continues more than approximately 3 minutes, the drum will stop rolling, and the standby mode is canceled. This is to protect the tape and to prevent from unnecessarily battery exhausting. To resume recording, press START/STOP again.

## **TIME/LANGU.** **menu**

(CLOCK SET/WORLD TIME/LANGUAGE)

See page 44 for details on selecting menu items.

### CLOCK SET

See page 19.

### WORLD TIME

When using your camcorder abroad, you can set the time difference by touching , the clock will be adjusted in accordance with the time difference. If you set the time difference to 0, the clock returns to the originally set time.

### LANGUAGE

You can select the language to be used on the LCD screen.

- Your camcorder offers [ENG[SIMP]] (simplified English) for when you cannot find your native tongue among the options.

# Customizing Personal Menu

You can add desired menu items to Personal Menu, and customize Personal Menu settings for each POWER lamp position. This is convenient if you add frequently used menu items to Personal Menu.

## Adding a menu item

You can add up to 28 menu items for each POWER switch position. Delete a less important menu item, if you want to add more.

- 1 Touch **[P-MENU]** → **[P-MENU SET UP]** → **[ADD]**.

If the desired menu item is not displayed, touch **[▲]/[▼]**.

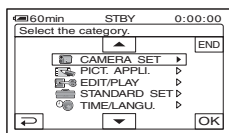

- 2 Touch **[▲]/[▼]** to select a menu category, then touch **[OK]**.

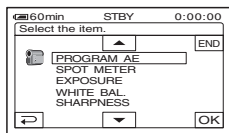

- 3 Touch **[▲]/[▼]** to select a menu item, then touch **[OK]** → **[YES]** → **[X]**.

The menu item is added to the end of list.

## Deleting a menu item

- 1 Touch **[P-MENU]** → **[P-MENU SET UP]** → **[DELETE]**.

If the desired menu item is not displayed, touch **[▲]/[▼]**.

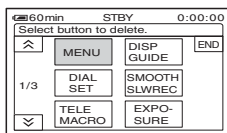

- 2 Touch the menu item that you want to delete.

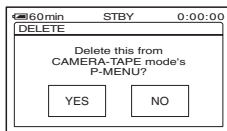

- 3 Touch **[YES]** → **[X]**.

- You cannot delete **[MENU]** and **[P-MENU SET UP]**.

## Customizing Personal Menu (Continued)

### Arranging the order of menu items displayed on Personal Menu

- 1 Touch **[P-MENU]** → **[P-MENU SET UP]** → **[SORT]**.

If the desired menu item is not displayed, touch **[↕]/[↕]**.

- 2 Touch the menu item you want to move.

- 3 Touch **[▲]/[▼]** to move the menu item to the desired place.

- 4 Touch **[OK]**.

To sort more items, repeat steps 2 to 4.

- 5 Touch **[END]** → **[X]**.

• You cannot move [P-MENU SET UP].

### Initializing the Personal Menu settings (Reset)

- Touch **[P-MENU]** → **[P-MENU SET UP]** → **[RESET]** → **[YES]** → **[YES]** → **[X]**.

If the desired menu item is not displayed, touch **[↕]/[↕]**.

## Using the CAM CTRL dial

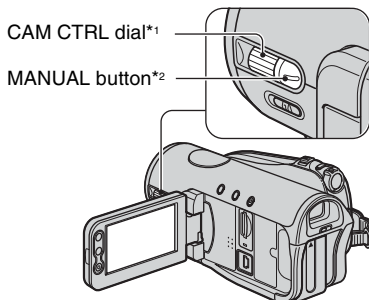

\*1 You can adjust the assigned item manually.

\*2 Press this button to switch the assigned item auto/manual setting.

You can assign some of your setting items to the CAM CTRL dial and adjust the following settings with the dial operation. The settings that can be set with the dial operation are the same with those on the menu. The default setting is [FOCUS].

### Items that can be set

- [FOCUS] (p. 50)
- [EXPOSURE] (p. 49)
- [AE SHIFT] (p. 50)
- [WB SHIFT] (p. 50)
- You can easily change settings only with the CAM CTRL dial and the MANUAL button while recording.
- During playback (when the POWER switch is set to PLAY/EDIT), you can adjust the volume with the CAM CTRL dial (p. 27).

## Setting with the CAM CTRL dial

The following is an example of the procedure to adjust the [FOCUS] setting manually. The procedure is the same for other setting items.

### 1 Set the POWER switch to CAMERA-TAPE or CAMERA-MEMORY.

### 2 Press the MANUAL button.

The indicator of the setting item appears on the screen.



- See page 34 for the name and display position of the indicators.

### 3 Rotate the CAM CTRL dial and adjust the setting.

Adjust the focus manually for the [FOCUS] setting.

Press the MANUAL button again when you want to return to the auto setting.

## Changing the item assigned to the CAM CTRL dial

Select the setting item from the [DIAL SET] menu to change the item assigned to the CAM CTRL dial (p. 53). You can also assign the item with the following procedure.

### 1 Set the POWER switch to CAMERA-TAPE or CAMERA-MEMORY.

### 2 Press and hold the MANUAL button for several seconds.

The [DIAL SET] screen appears.

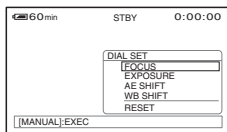

### 3 Rotate the CAM CTRL dial and select an item to be assigned.

### 4 Press the MANUAL button.

A message appears and you can set the selected item with the dial operation.



- Manual settings will be retained even if you change an assigned item. If [EXPOSURE] is set after [AE SHIFT] is set manually, [EXPOSURE] will override [AE SHIFT].
- If you select [RESET] in step 3, all the settings set manually return to the default setting. The item assigned to the CAM CTRL dial returns to [FOCUS].

# Dubbing to VCR/DVD device, etc.

Connect your camcorder to the wall socket using the supplied AC Adaptor for this operation (p. 11). Refer also to the instruction manuals supplied with the devices to be connected.

## Connecting to external devices

The connection method and the image quality will differ depending on the VCR/DVD device and the connectors used.

 : Signal flow

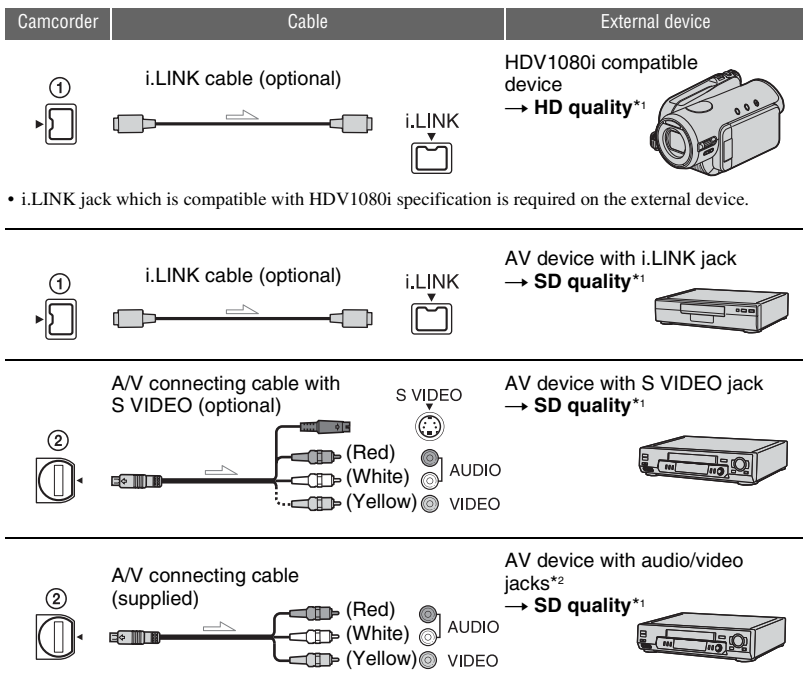

<sup>\*1</sup> Pictures recorded in the DV format are played back as SD (standard definition) images, regardless of the connection.

<sup>\*2</sup> When connecting your camcorder to a monaural device, connect the yellow plug of the A/V connecting cable to the video jack on the device, and the white (left channel) or red (right channel) plug to the audio jack on the device.

- You cannot dub pictures using the HDMI cable.

## Jacks on your camcorder

Open the jack cover and connect the cable.

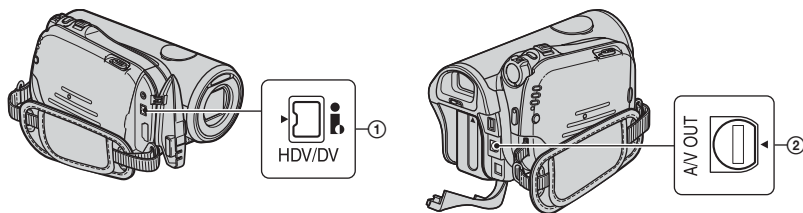

## Using an i.LINK cable (optional)

The dubbed format (HDV/DV) differs depending on the recording format or the format supported by the VCR/DVD device. Select the required settings from the table below and make the menu settings.

- Disconnect the i.LINK cable before changing these menu settings, otherwise the VCR/DVD device may not correctly identify the video signal.

Copy format	Camcorder recording format	Format supported by the VCR/DVD device		Menu setting	
		HDV format* <sup>1</sup>	DV format	[VCR HDV/DV] (p. 61)	[i.LINK CONV] (p. 64)
Copy HDV recording as HDV	HDV	HDV	—* <sup>3</sup>		[OFF]
Convert HDV recording to DV	HDV	DV	DV	[AUTO]	[ON (HDV → DV)]
Copy DV recording as DV	DV	DV	DV		[OFF]
When tape is recorded in both HDV and DV format					
Convert both HDV and DV format to DV	HDV/DV	DV	DV	[AUTO]	[ON (HDV → DV)]
Copy only portions recorded in HDV format	HDV	HDV	—* <sup>3</sup>	[HDV]	[OFF]
	DV	—* <sup>2</sup>	—* <sup>3</sup>		
Copy only portions recorded in DV format	HDV	—* <sup>2</sup>	—* <sup>2</sup>	[DV]	[OFF]
	DV	DV	DV		

\*<sup>1</sup> Recording device compliant with the HDV1080i specification.

\*<sup>2</sup> The tape advances, but no video or sound is recorded (blank).

\*<sup>3</sup> Picture is not recognized (no recording is made).

## Dubbing to VCR/DVD device, etc. (Continued)

- When [VCR HDV/DV] is set to [AUTO], and the signal switches between HDV and DV formats, the picture and sound are interrupted temporarily.
- When the recorder is HDR-HC3E, set [VCR HDV/DV] to [AUTO] on the recorder and the player (p. 61).
- When the player and the recorder are both HDV1080i compatible devices such as HDR-HC3E and connected with the i.LINK cable, after pausing or stopping and then resuming the recording, the images will be a bit choppy or rough at that point.
- Set [DISP OUTPUT] to [LCD PANEL] (default setting) when connecting with an A/V connecting cable (p. 65).

### When connecting with the A/V connecting cable with S VIDEO (optional)

Connect with S VIDEO jack instead of the video plug (yellow). This connection produces pictures more faithfully. This connection produces higher quality DV format pictures. The audio will not be output when you connect with the S VIDEO cable alone.

## Dubbing to another device

### 1 Prepare your camcorder for playback.

Insert the recorded cassette.  
Slide the POWER switch to turn on the PLAY/EDIT lamp.

Set [TV TYPE] according to the playback device (TV, etc.) (p. 64).

### 2 Prepare your VCR/DVD device for recording.

When dubbing to the VCR, insert a cassette for recording.  
When dubbing to the DVD recorder, insert a DVD for recording.

If your recording device has an input selector, set it to the appropriate input (such as video input1 and video input2).



### 3 Connect your VCR/DVD device to your camcorder as a recording device.

See page 70 for connection details.

### 4 Start playback on the camcorder, and recording on the VCR/DVD device.



Refer to the operating instructions supplied with your recording device for details.

### 5 When dubbing is complete, stop your camcorder and the VCR/DVD device.

- To record the date/time and camera settings data when connected by the A/V connecting cable, display them on the screen (p. 64).
- The following cannot be output via the  HDV/DV interface (i.LINK):
  - Indicators
  - Pictures edited with [PICT.EFFECT] (p. 58) or [D.EFFECT] (p. 57)
  - Titles that are recorded on other camcorder
- Pictures recorded in the HDV format are not output from the  HDV/DV Interface (i.LINK) jack during playback pause or in any playback mode other than normal playback.
- Note the following when connecting with an i.LINK cable:
  - The recorded picture becomes rough when a picture is paused on your camcorder while recording to a VCR/DVD device.
  - Data codes (date/time/camera settings data) may not be displayed or recorded depending on the device or application.
  - You cannot record the picture and sound separately.



## Recording pictures from a VCR

- When dubbing to a DVD recorder from your camcorder in DV format through an i.LINK cable, you may not operate your camcorder on your DVD recorder even its instruction manual says you can.  
If you can set the input mode to DV on your DVD recorder and can input/output pictures, follow the steps in “Dubbing to another device.”
- When you use an i.LINK cable, the video and sound signals are transmitted digitally, producing high quality pictures.
- When an i.LINK cable is connected, the format of the output signal (**HDVOUT  or DVOUT **) will be indicated on the LCD screen of your camcorder.

You can record pictures from a VCR on a tape. You can record a scene as a still image on a “Memory Stick Duo.” Be sure to insert a cassette or a “Memory Stick Duo” for recording in your camcorder beforehand. You can connect your camcorder to a VCR device using an i.LINK cable. Connect your camcorder to the wall socket using the supplied AC Adaptor for this operation (p. 11). Refer also to the instruction manuals supplied with the devices to be connected.

- You need an i.LINK cable for this operation.
- Your camcorder can only record from a PAL source. For example, French video or TV programs (SECAM) cannot be recorded correctly. See page 107 for details on TV color systems.
- If you use a 21-pin adaptor (optional) to input the PAL source, you need a dual direction 21-pin adaptor (optional).

## Recording pictures from a VCR (Continued)

HDV1080i  
compatible device



→ HD quality

AV device with  
i.LINK jack



→ SD quality

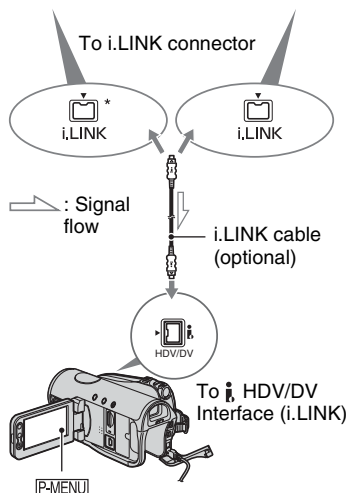

\* An i.LINK jack which is compatible with HDV1080i specification is required.

### Recording movies



**1** Slide the POWER switch to turn on the PLAY/EDIT lamp.

**2** Set the input signal of your camcorder.

Set [VCR HDV/DV] to [AUTO] when recording from an HDV format compatible device.

Set [VCR HDV/DV] to [DV] or [AUTO] when recording from a DV format compatible device (p. 61).



**3** Connect your VCR as a player to your camcorder.

When an i.LINK cable is connected, the format of the input signal (HDV IN  or DV IN ) will be indicated on the LCD screen of your camcorder (This indicator may appear on the screen of the playback device, however, it will not be recorded).

**4** Insert a cassette into the VCR.

**5** Operate your camcorder to record movies.

Touch [P-MENU] →  REC CTRL → [REC PAUSE].

If the desired item is not displayed on the screen, touch / until the item is displayed.

**6** Start playing the cassette on your VCR.

The picture played on the connected device appears on the LCD screen of your camcorder.

**7** Touch [REC START] at the point you want to start recording.

**8** Stop recording.

Touch  (Stop) or [REC PAUSE].

---

## 9 Touch → .

---

- You cannot record TV programs from the  i.LINK interface (i.LINK).
- You can record pictures from DV devices only in the DV format.
- Note the following when connecting with an i.LINK cable:
  - The recorded picture becomes rough when a picture is paused on your camcorder while recording to a VCR.
  - You cannot record the picture and sound separately.
  - If you pause or stop the recording and restart it, the picture may not be recorded smoothly.
- When a 4:3 video signal is input, it appears with black bands on the right and left sides on the screen of your camcorder.

### Recording still images

---

#### 1 Perform steps 1 to 4 in “Recording movies.”

---

#### 2 Start playing the cassette.

The pictures on the VCR appear on the screen of your camcorder.

---

#### 3 Press PHOTO lightly at the scene you want to record. Check the image and press it fully.

---

## Dubbing pictures from a tape to a “Memory Stick Duo”

You can record still images on a “Memory Stick Duo.” Make sure you have a recorded tape and a “Memory Stick Duo” inserted into your camcorder.

---



#### 1 Slide the POWER switch to turn on the PLAY/EDIT lamp.

---

#### 2 Search and record the scene you want to record.

Touch  (Play) to play back the tape, then press PHOTO lightly at the scene you want to record. Check the image and press it fully.

---

- The date and time the picture is recorded on the tape and stored on the “Memory Stick Duo” are recorded. On your camcorder, the date and time the picture is recorded on the tape are displayed. Camera setting data recorded on the tape cannot be stored on the “Memory Stick Duo.”
- Still images will be fixed to image size  1.2M] when playing back in the HDV format. Still images will be fixed to image size  0.2M] (16:9) or [VGA (0.3M)] (4:3) when playing back in the DV format (p. 55).
- You cannot record still images while using PB zoom.

# Deleting recorded pictures from the “Memory Stick Duo”

**1** Slide the POWER switch to turn on the PLAY/EDIT lamp.

**2** Touch **[MEMORY]**.

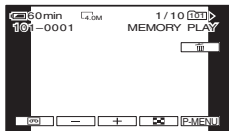

**3** Select a picture you want to delete with **[-]/[+]**.

- To delete all pictures at once, select **[ALL]** [ALL ERASE] (p. 55).

**4** Touch **[DELETE]** → **[YES]**.

- The pictures cannot be restored once they are deleted.

- You can delete pictures on the index screen (p. 27). You can easily search for the picture to be deleted by displaying 6 pictures at once. Touch **[SET]** → **[DELETE]** → the picture you want to delete → **[OK]** → **[YES]**.
- Pictures cannot be deleted when a “Memory Stick Duo” with the write-protect tab is set to the write-protect position (p. 110), or when the selected picture is protected (p. 77).

# Marking images on the “Memory Stick Duo” with specific information (Print mark/Image protection)

When you are using a “Memory Stick Duo” with the write-protect tab, make sure the write-protect tab on the “Memory Stick Duo” is not set to the write-protect position (p. 110).

## Selecting still images for printing (Print mark)

The DPOF (Digital Print Order Format) standard is used to select images for printing on your camcorder.

By marking images that you want to print out, you do not need to reselect them when you print them out (You cannot specify the number of printouts).

**1** Slide the POWER switch to turn on the PLAY/EDIT lamp.

**2** Touch **[MEMORY]** → **[PRINT MARK]** → **[SET]** → **[PRINT MARK]**.

**3** Touch the image that you want to print out later.

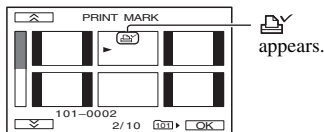

**4** Touch **[OK]** → **[END]**.

- To cancel Print mark, touch the image again to cancel Print mark in step 3.

- Do not mark images on your camcorder if the “Memory Stick Duo” already has some images with the Print mark put on using other devices. This may change the information of the images with the Print mark put on using the other device.

## Preventing accidental erasure (Image protection)

You can select and mark images to prevent accidental erasure.

**1** Slide the POWER switch to turn on the PLAY/EDIT lamp.

**2** Touch [MEMORY] →  → [SET] → [PROTECT].

**3** Touch the image that you want to protect.

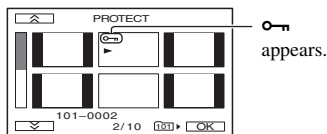

**4** Touch [OK] → [END].

- To cancel image protection, touch the image again to cancel image protection in step 3.

## Printing recorded images (PictBridge compliant printer)

You can print out pictures using a PictBridge compliant printer without connecting the camcorder to a computer.

### PictBridge

Connect your camcorder to the AC Adaptor to obtain power from the wall socket. Insert the “Memory Stick Duo” containing still images into your camcorder and turn on the printer.

## Connecting your camcorder to the printer

**1** Slide the POWER switch to turn on the PLAY/EDIT lamp.

**2** Connect the  (USB) jack of your camcorder to the printer using the USB cable. [USB SELECT] appears on the screen automatically.

**3** Touch [PictBridge PRINT].

When connection is complete,  (PictBridge connecting) appears on the screen.

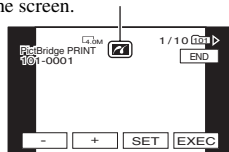

One of the images stored on the “Memory Stick Duo” will be displayed.

- You can also operate by selecting in the following orders:  
 – [P-MENU] → [MENU] →  (PICT.APPLI.) → [USB SELECT] → [PictBridge PRINT].

## Printing recorded images (PictBridge compliant printer) (Continued)

– [P-MENU] → [MENU] →  (PICT.APPLI.)  
→ [PictBridge PRINT].

- We cannot guarantee the operation of models that are not PictBridge compatible.

### Printing



---

**1** Select the image to be printed with  / .

---

**2** Touch [SET] → [COPIES].

---

**3** Select the number of copies to be printed with  / .

A maximum of 20 copies of the image can be printed.

---

**4** Touch [OK] → [END].

To print the date/time on the image, touch [SET] → [DATE/TIME] → [DATE] or [DAY&TIME] → [OK].

---

**5** Touch [EXEC] → [YES].

When printing is finished, [Printing...] disappears and the image selection screen appears again.

Touch [END] when printing is completed.

- 
- Refer also to the operating instructions for the printer to be used.
  - Do not attempt the following operations when  is on the screen. The operations may not be performed properly.
    - Operate the POWER switch.
    - Disconnect the USB cable from the printer.
    - Remove the “Memory Stick Duo” from your camcorder.

- If the printer stops working, disconnect the USB cable, turn the printer off and on again and restart the operation from the beginning.
- If you print a still image recorded with a 16:9 ratio, left and right ends of the image may be cut off.
- Some printer models may not support the date/time printing function. Refer to your printer’s operating instructions for details.
- We cannot guarantee the printing of images recorded with a device other than your camcorder.
- PictBridge is an industry standard established by the Camera & Imaging Products Association (CIPA). You can print still images without using a computer by connecting a printer directly to a digital video camera or digital still camera, regardless of model or manufacturer.

# Jacks to connect external devices

## Camcorder

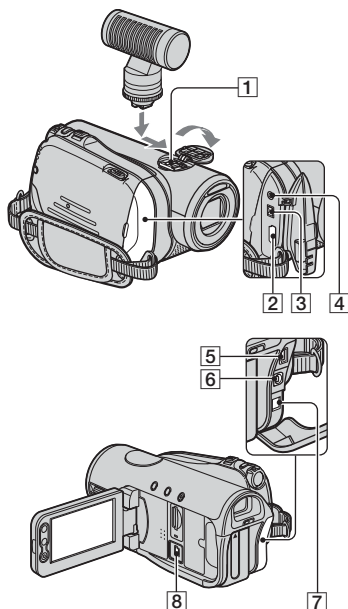

- 1 ...Open the shoe cover.
- 2 - 7 ...Open the jack cover.
- 8 ...Open the LCD panel.

### 1 Active Interface Shoe Active Interface Shoe

The Active Interface Shoe supplies power to optional accessories such as a video light, a flash, or a microphone. The accessory can be turned on or off as you operate the POWER switch on your camcorder. Refer to the operating instructions supplied with your accessory for details.

- When you connect an accessory, open the shoe cover.
- The Active Interface Shoe has a safety device for fixing the installed accessory securely. To connect an accessory, press down and push it to the end, and then tighten the screw. To remove an accessory,

loosen the screw, and then press down and pull out the accessory.

- Connecting with an external device wears out the battery pack faster.
- When you are recording movies with an external flash (optional) connected to the accessory shoe, turn off the power of the external flash to prevent charging noise being recorded.
- You cannot use an external flash (optional) and the built-in flash at the same time.
- When an external microphone (optional) is connected, it takes precedence over the internal microphone (p. 31).

### 2 HDMI OUT jack (p. 38)

- The available video signals are read, and the appropriate output format is selected and output automatically.
- You can check the setup value of HDMI OUTPUT on [STATUS CHECK] (p. 64).

### 3 HDV/DV Interface (i.LINK) (p. 38, 70, 85)

### 4 LANC jack (blue)

- The LANC control jack is used for controlling the tape transport of video devices and peripherals connected to it.

### 5 COMPONENT OUT jack (p. 38)

### 6 A/V (audio/video) OUT jack (p. 38, 70)

### 7 DC IN jack (p. 11)

### 8 $\Psi$ (USB) jack (p. 77, 80)

## Connecting to a computer

When connecting your camcorder to the computer, the following operations are available:

Copying the still images on a “Memory Stick Duo” to the computer

→ p. 80

Copying the movie on a tape in the HDV format to the computer

→ p. 83

Copying the movie on a tape in the DV format to the computer

→ p. 83

### About connection

There are 2 ways to connect your camcorder to a computer:

– USB cable

When copying pictures on a “Memory Stick Duo”

– i.LINK cable

When copying pictures on a tape

### Notes on connecting to a computer

- When you are using a USB cable or an i.LINK cable to connect your camcorder to a computer, make sure you insert the connector in the correct direction. If you insert the connector forcibly, it may be damaged, and cause a malfunction of your camcorder.
- You cannot do the following:
  - Copying pictures on a tape to a computer with a USB cable.
  - Copying pictures on a “Memory Stick Duo” to a computer with an i.LINK cable.
- Remove the USB cable according to the correct procedure when disconnecting it from the computer (p. 82).

## Copying still images to a computer

### System requirements

#### For Windows users

- OS: Windows 2000 Professional/Windows Millennium Edition/Windows XP Home Edition/Windows XP Professional Standard installation is required. Operation is not assured if the above OS has been upgraded.
- CPU: MMX Pentium 200MHz or faster
- Others: USB port (This must be provided as standard.)

#### For Macintosh users

- OS: Mac OS 9.1/9.2 or Mac OS X (v10.1/v10.2/v10.3/v10.4)
- Others: USB port (This must be provided as standard.)

### Using the USB cable

- You can do this operation with the standard driver of your computer. You do not need to install any software.
- If your computer has a Memory Stick slot, insert the “Memory Stick Duo” on which pictures are recorded into the Memory Stick Duo adaptor (optional), then insert it into the Memory Stick slot on your computer to copy still images to the computer.
- When using a “Memory Stick PRO Duo” and your computer is not compatible with it, connect your camcorder with the USB cable instead of using the Memory Stick slot on the computer.



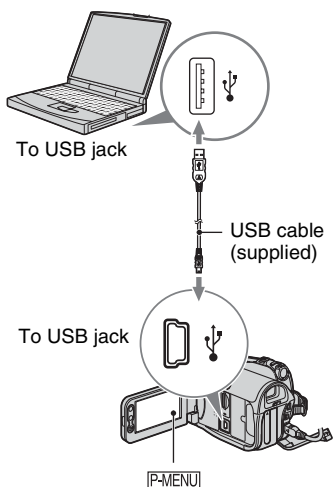

- Do not connect your camcorder to the computer at this point.
- The computer may not recognize the camcorder if you connect them with the USB cable before turning on your camcorder.
- Refer to page 83 for the recommended connection.

## 1 Turn on the computer.

Close down all applications running on the computer.

### For Windows 2000/Windows XP

Log on as an Administrator.

## 2 Insert a “Memory Stick Duo” into your camcorder.

## 3 Prepare the power source for your camcorder.

Use the supplied AC Adaptor as the power source (p. 11).

## 4 Slide the POWER switch to turn on the PLAY/EDIT lamp.

## 5 Connect the USB cable to the (USB) jack on your camcorder and the USB jack on your computer.

[USB SELECT] appears on the LCD screen of your camcorder.

## 6 Touch [Memory Stick].

It may take some time for the computer to recognize the camcorder when you connect the USB cable for the first time.

- You can also select [Memory Stick] from [USB SELECT] of [PICT.APPLI].
- During the Easy Handycam operation, you can set by connecting the USB cable.

## Copying the pictures

### For Windows users

Double-click the [Removable Disk] icon displayed in [My Computer]. Then, drag and drop a picture in the folder onto the hard disk drive of your computer.

## Copying still images to a computer (Continued)

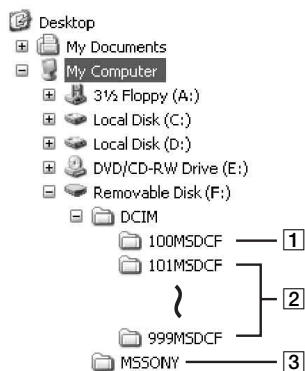

- 1 Folder containing image files recorded using other camcorders without the folder creation function (for playback only)
- 2 Folder containing image files recorded with your camcorder  
When no new folders have been created, only [101MSDCF] is displayed.
- 3 Folder containing movie data recorded using other camcorders without the folder creation function (for playback only)

Folder	File	Meaning
101MSDCF (up	DSC0□□	Still image
to 999MSDCF)	□□.JPG	file

□□□□ stands for any number between 0001 and 9999.

### For Macintosh users

Double-click the drive icon, then drag and drop the desired picture file onto the hard disk of your computer.

## Disconnecting the USB cable

### For Windows users

If [USB CONNECT] appears on the LCD screen, follow the procedure below to disconnect the USB cable.

- 1 Click the [Unplug or eject hardware] icon on the task tray.

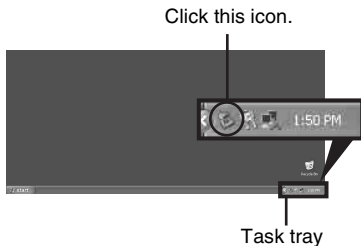

- 2 Click [Safely remove USB Mass Storage Device-Drive].



- 3 Click [OK].
- 4 Disconnect the USB cable from the camcorder and computer.

If [USB CONNECT] does not appear on the LCD screen, do only step 4 above.

- Remove the USB cable according to the correct procedure, otherwise files in the "Memory Stick Duo" may not be updated correctly. Also, this may cause a malfunction of the "Memory Stick Duo."

### For Macintosh users

- 1 Close down all applications running on the computer.
- 2 Drag and drop the drive icon on the desktop onto the [Trash] icon.
- 3 Disconnect the USB cable from the camcorder and computer.

# Copying movies on a tape to the computer

- If you are using Mac OS X, turn off the computer before disconnecting the USB cable and ejecting the “Memory Stick Duo.”
- Do not disconnect the USB cable while the access lamp is lit.
- Make sure to disconnect the USB cable before turning off your camcorder.

## Recommended connection

Observe the following points when connecting to ensure the camcorder operates correctly.

- Connect the camcorder to a computer via the USB cable. Make sure no other USB devices are connected to the computer.
- If your computer has a USB keyboard and a USB mouse as standard equipment, leave them connected and connect the camcorder to an available USB jack with the USB cable.
- Operation is not guaranteed if you connect two or more USB devices to the computer.
- Operation is not guaranteed if you connect the USB cable to the USB jack on a keyboard or USB hub.
- Make sure to connect the cable to the USB jack on the computer.
- Operation is not guaranteed even for the recommended environments.

Connect your camcorder to the computer with an i.LINK cable.

The computer needs to have an i.LINK connector and be installed with editing software that can copy video signals. The software required depends on the format of the recorded pictures and the format for copying to the computer (HDV or DV) as shown in the table below.

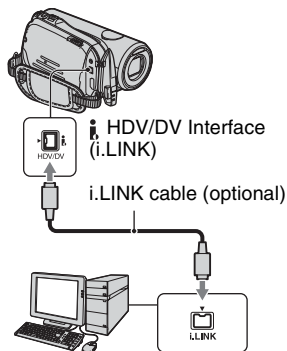

Format for copying to the computer	Recorded format	Required software
HDV	HDV	Editing software capable of copying HDV signal
DV	HDV	Editing software capable of copying DV signal
DV	DV	Editing software capable of copying DV signal

- Refer to the operating instructions of the software for the details on image copying.
- Refer to the operating instructions of the editing software for the recommended connection.
- Some editing software on the computer may not work correctly.



## Copying movies on a tape to the computer (Continued)

### Notes on connecting to the computer

- Connect the i.LINK cable to the computer first, then to your camcorder. Connecting in the opposite order may cause static electricity to build up, resulting in a malfunction of your camcorder.
- The computer may freeze or may not recognize the signal from your camcorder in the following situations.
  - Connecting your camcorder to a computer that does not support the video signal formats appearing on the LCD screen of your camcorder display (HDV or DV).
  - Changing the [VCR HDV/DV] and [i.LINK CONV] settings on the  (STANDARD SET) menu while connected with an i.LINK cable.
  - Changing the [REC FORMAT] setting on the  (STANDARD SET) menu while connected with an i.LINK cable with the POWER switch set to CAMERA-TAPE.
  - Changing the POWER switch position while connected with an i.LINK cable.
- The format (HDV or DV) of input/output signal appears on the LCD screen of your camcorder while connected with an i.LINK cable.

### When setting up your camcorder

The menu settings required depend on the format of the recorded pictures and the format for copying.

Format for copying to the computer	Menu setting*	Recorded format
HDV	[VCR HDV/DV] → [HDV] [i.LINK CONV] → [OFF]	HDV
DV	[VCR HDV/DV] → [HDV] [i.LINK CONV] → [ON (HDV → DV)]	HDV
DV	[VCR HDV/DV] → [DV] [i.LINK CONV] → [OFF]	DV

\* See page 61 for [VCR HDV/DV] and 64 for [i.LINK CONV].

- A tape recorded in the DV format cannot be copied in the HDV format to a computer.
- You can create DVDs from a tape by connecting your camcorder to a Sony VAIO series computer that has “Click to DVD Ver.2.3” or later installed (p. 85). The quality of the picture to be copied to DVDs is SD (standard definition).

### When copying the movie in the HDV format from the computer to your camcorder

Set [VCR HDV/DV] to [HDV] and [i.LINK CONV] to [OFF] on the  (STANDARD SET) menu (p. 61, 64).

### When copying the movie in the DV format from the computer to your camcorder

Set [VCR HDV/DV] to [DV] on the  (STANDARD SET) menu (p. 61).

# Creating a DVD (Direct Access to “Click to DVD”)

i.LINK

You can create a DVD from a tape with a Sony VAIO series computer\* preinstalled with “Click to DVD,” via an i.LINK cable. The picture is automatically copied and written to a DVD.

The following procedures describe how to create a DVD from a recorded tape. For details of compatible computers, operating environment, “Click to DVD,” and upgrading to “Click to DVD Ver.2.3” or later, visit the following URL:

– Europe

<http://www.vaio-link.com/>

– USA

<http://cisddb.sel.sony.com/perl/select-p-n.pl>

– Asia Pacific Regional

<http://www.css.ap.sony.com/>

– Korea

<http://scs.sony.co.kr/>

– Taiwan

<http://vaio-online.sony.com/tw/vaio/>

– China

<http://www.sonystyle.com.cn/vaio/>

– Thailand

<http://www.sony.co.th/vaio/index.html>

– Latin America

<http://www.sony-latin.com/vaio/info/index.jsp>

\* Note that you need a computer with a DVD drive that can be used to write DVDs, and “Click to DVD Ver.2.3” (Sony original software) or later installed.

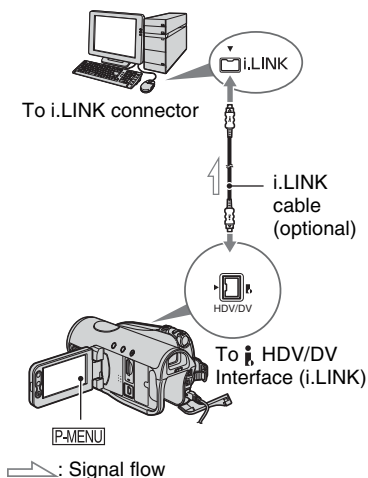

- Images recorded in HDV format are down-converted to SD (standard definition) quality when copying to DVDs (They are not copied in the HD (high definition) quality).
- You can only use an i.LINK cable for this operation. You cannot use a USB cable.

## Using the Direct Access to “Click to DVD” function for the first time

The Direct Access to “Click to DVD” function enables you to copy pictures recorded on a tape to a DVD easily if your camcorder is connected to a computer. Before operating the Direct Access to “Click to DVD” function, follow the steps below to start “Click to DVD Automatic Mode Launcher.”

- ① Turn on the computer.
- ② Click the start menu, then select [All Programs].
- ③ Select [Click to DVD] from the programs displayed, then click [Click to DVD Automatic Mode Launcher].  
[Click to DVD Automatic Mode Launcher] starts up.

- After you start up [Click to DVD Automatic Mode Launcher] once, from then on it starts up automatically when you turn on your computer.
- [Click to DVD Automatic Mode Launcher] is set up for each Windows XP user.

---

## 1 Turn on the computer.

Close all applications running with an i.LINK.

---

## 2 Prepare the power source for the camcorder.

Use the supplied AC Adaptor as the power source since it takes a few hours to create a DVD.

---

## 3 Slide the POWER switch to turn on the PLAY/EDIT lamp.

---

## 4 Touch → [MENU] → (STANDARD SET) → [i.LINK CONV] → [ON (HDV → DV)] → .

---

## 5 Insert a recorded cassette into your camcorder.

---

## 6 Connect your camcorder to a computer via an i.LINK cable (p. 85).

- When you connect your camcorder to a computer, make sure you insert the connector in the correct way. If you insert the connector forcibly, damage may occur and cause camcorder malfunction.

---

## 7 Touch → [MENU] → (EDIT/PLAY) → [BURN DVD] → .

“Click to DVD” starts up and the on-screen instructions appear on your computer.

---

## 8 Place a writable DVD in the disc drive of the computer.

---

## 9 Touch [EXEC] on the screen of your camcorder.

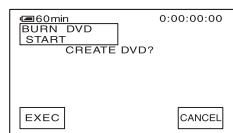

The status of the operation on your computer is displayed on the LCD screen of your camcorder.

CAPTURING: The picture recorded on the tape is being copied to the computer.

CONVERTING: The picture is being converted to the MPEG2 format.

WRITING: The picture is being written onto the DVD.

- If you use a DVD-RW/+RW which has other data stored on it, the message [This is a recorded disc. Delete and overwrite?] appears on the LCD screen of your camcorder. When you touch [EXEC], the existing data is erased and new data is written.

---

## 10 Touch [NO] to finish creating a DVD.

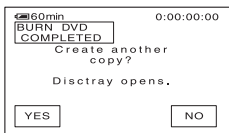

The disc tray comes out automatically. To create another DVD with the same content, touch [YES]. The disc tray comes out. Place a new writable DVD in the disc drive. Then, repeat steps 9 and 10.

---

## To cancel the operation

Touch [CANCEL] on the LCD screen on your camcorder.

- You cannot cancel the operation after [Finalizing DVD.] is displayed on the LCD screen of your camcorder.
- Do not disconnect the i.LINK cable or set the POWER switch to another mode on your camcorder until the picture is completely copied to the computer.
- When [CONVERTING] or [WRITING] is displayed on the screen, capturing of pictures has already finished. Even if you disconnect the i.LINK cable or turn off the camcorder at this stage, DVD creation will continue on your computer.
- If any of the following occurs, copying of the picture is canceled. A DVD containing the data up to the point the operation was canceled is created. Refer to the help files of “Click to DVD” for details.
  - The tape contains a 10-second or longer blank portion.
  - The tape contains a date before the date of later images.
  - Both 16:9 (wide) and 4:3 pictures are recorded on the same tape.
- You cannot create a DVD in the following situations:
  - While a tape is running.

- While recording images onto a “Memory Stick Duo.”
- When “Click to DVD” is started up from the computer.

# Troubleshooting

If you run into any problems using your camcorder, use the following table to troubleshoot the problem. If the problem persists, disconnect the power source and contact your Sony dealer.

## Overall operations/Easy Handycam

### The power does not turn on.

- Attach a charged battery pack to the camcorder (p. 11).
- Use the AC Adaptor to connect to a wall socket (p. 11).

---

### The camcorder does not operate even when the power is set to on.

- Disconnect the AC Adaptor from the wall socket or remove the battery pack, then reconnect it after about 1 minute.
- Press the RESET button (p. 31) using a sharp-pointed object (If you press the RESET button, all settings are reset, except Personal Menu items).

---

### Buttons do not work.

- During Easy Handycam operation, not all buttons are functional (p. 24).

---

### You cannot turn Easy Handycam operation on or off.

- During recording or communicating with another device via USB cable, you cannot turn Easy Handycam operation on or off.

---

### Settings change during Easy Handycam operation.

- During Easy Handycam operation, the settings of the functions that are not displayed on the screen return to their defaults (p. 22, 46).

---

### [DEMO MODE] does not start.

- Eject the cassette and “Memory Stick Duo” from your camcorder (p. 20, 21).

---

### The camcorder gets warm.

- The camcorder may get warmer while you use it. This is not a malfunction.

## Batteries/Power sources

### The power abruptly turns off.

- When approximately 5 minutes have elapsed while you do not operate your camcorder, the camcorder is automatically turned off (A.SHUT OFF). Change the setting of [A.SHUT OFF] (p. 66), or turn on the power again (p. 15), or use the AC Adaptor.
- Charge the battery pack (p. 11).



---

**The CHG (charge) lamp does not light while the battery pack is being charged.**

- Slide the POWER switch to OFF (CHG) (p. 11).
- Attach the battery pack to the camcorder correctly (p. 11).
- Connect the mains lead to the wall socket properly.
- The battery charge is completed (p. 11).

---

**The CHG (charge) lamp flashes while the battery pack is being charged.**

- Attach the battery pack to the camcorder correctly (p. 11). If the problem persists, disconnect the AC Adaptor from the wall socket and contact your Sony dealer. The battery pack may be damaged.

---

**The power turns off frequently although the remaining battery time indicator indicates that the battery pack has enough power to operate.**

- A problem has occurred in the remaining battery time indicator, or the battery pack has not been charged enough. Fully charge the battery again to correct the indication (p. 11).

---

**The remaining battery time indicator does not indicate the correct time.**

- Ambient temperature is too high or too low, or the battery pack has not been charged enough. This is not a malfunction.
- Fully charge the battery again. If the problem persists, the battery may be worn-out. Replace it with a new one (p. 11, 112).
- The indicated time may not be correct in certain circumstances. For example, when you open or close the LCD panel, it takes about 1 minute to display the correct remaining battery time.

---

**The battery pack discharges too quickly.**

- Ambient temperature is too high or low, or the battery pack has not been charged enough. This is not a malfunction.
- Fully charge the battery again. If the problem persists, the battery may be worn-out. Replace it with a new one (p. 11, 112).

---

**A problem occurs when the camcorder is connected to the AC Adaptor.**

- Turn off the power, and disconnect the AC Adaptor from the wall socket. Then, connect it again.

---

**LCD screen/viewfinder****An unknown picture appears on the LCD screen or viewfinder.**

- The camcorder is in [DEMO MODE] (p. 60). Touch the LCD screen or insert a cassette or a "Memory Stick Duo" to cancel [DEMO MODE].

---

**An unknown indicator appears on the screen.**

- A warning indicator or message appears on the screen (p. 103).

## Troubleshooting (Continued)

---



### The picture remains on the LCD screen.

- This occurs if you disconnect the DC plug or remove the battery pack without turning off the power first. This is not a malfunction.
- 

### You cannot turn the LCD backlight off.

- During Easy Handycam operation, you cannot turn the LCD backlight on/off by pressing and holding DISP/BATT INFO (p. 24).
- 

### You cannot turn off the indicators.

- You cannot turn off . Touch  to check the warning messages (p. 104).
- 

### The buttons do not appear on the touch panel.

- Touch the LCD screen lightly.
  - Press DISP/BATT INFO on your camcorder (or DISPLAY on the Remote Commander) (p. 17).
- 

### The buttons on the touch panel do not work correctly or do not work at all.

- Adjust the screen ([CALIBRATION]) (p. 116).
- 

### The picture in the viewfinder is not clear.

- Move the viewfinder lens adjustment lever until the picture appears clearly (p. 16).
- 

### The picture in the viewfinder has disappeared.

- Close the LCD panel. The picture is not displayed in the viewfinder when the LCD panel is open (p. 16).
- 

## Cassette tapes

### The cassette cannot be ejected from the compartment.

- Make sure the power source (battery pack or AC Adaptor) is connected correctly (p. 11).
  - Remove the battery pack from the camcorder, then attach it again (p. 12).
  - Attach a charged battery pack to the camcorder (p. 11).
  - Moisture condensation has occurred inside the camcorder (p. 115).
- 

### The Cassette Memory indicator or title display does not appear while using a cassette with Cassette Memory.

- This camcorder does not support Cassette Memory, so the indicator does not appear.
- 

### The remaining tape indicator is not displayed.

- Set  to [ON] to always display the remaining tape indicator (p. 65).
-

---

**The cassette is noisier during rewinding or fast-forwarding.**

- When using the AC Adaptor, rewind/fast forward speed increases (compared with battery operation) and therefore increases noise. This is not a malfunction.

**“Memory Stick Duo”****You cannot operate functions using the “Memory Stick Duo.”**

- Slide the POWER switch to turn on the CAMERA-MEMORY or PLAY/EDIT lamp (p. 15).
- Insert a “Memory Stick Duo” into your camcorder (p. 20).
- If you use a “Memory Stick Duo” formatted on a computer, format it again on your camcorder (p. 56).

---

**Pictures cannot be deleted.**

- Release the lock on the write-protect tab of the “Memory Stick Duo” if there is one (p. 110).
- Cancel image protection on the picture (p. 77).
- The maximum number of pictures that you can delete on the index screen at one time is 100.

---

**You cannot delete all pictures at once.**

- Release the lock on the write-protect tab of the “Memory Stick Duo” if there is one (p. 110).
- Cancel image protection on the pictures (p. 77).

---

**You cannot format the “Memory Stick Duo.”**

- Release the lock on the write-protect tab of the “Memory Stick Duo” if there is one (p. 110).

---

**Image protection cannot be applied.**

- Release the lock on the write-protect tab of the “Memory Stick Duo” if there is one (p. 110).
- Perform the operation again on the index screen (p. 77).

---

**You cannot mark pictures for print.**

- Release the lock on the write-protect tab of the “Memory Stick Duo” if there is one (p. 110).
- Perform the operation again on the index screen (p. 76).
- The maximum number of pictures you can mark for print is 999.

---

**The data file name is not indicated correctly.**

- Only the file name is displayed if the directory structure does not conform to the universal standard.
- The file is damaged.
- The file format is not supported on your camcorder (p. 110).

### The data file name flashes.

- The file is damaged.
- The file format is not supported on your camcorder (p. 110).

## Recording

Refer also to “Adjusting the image during recording” (p. 93) and “Memory Stick Duo” section (p. 91).

---

### The tape does not start when you press START/STOP.

- Slide the POWER switch to turn on the CAMERA-TAPE lamp (p. 26).
- The tape has reached the end. Rewind it, or insert a new cassette.
- Set the write-protect tab to REC or insert a new cassette (p. 108).
- The tape is stuck to the drum due to moisture condensation. Remove the cassette and leave your camcorder for at least 1 hour, then re-insert the cassette (p. 115).

### You cannot record on the “Memory Stick Duo.”

- Release the lock on the write-protect tab of the “Memory Stick Duo” if there is one (p. 110).
- The “Memory Stick Duo” is full. Delete unnecessary pictures recorded on the “Memory Stick Duo” (p. 76).
- Format the “Memory Stick Duo” on your camcorder or insert another “Memory Stick Duo” (p. 56).
- You cannot record movies with this unit on the “Memory Stick Duo.”
- When the POWER switch is set to CAMERA-TAPE, you cannot record still images on the “Memory Stick Duo” with:
  - [PICT.EFFECT]
  - [D.EFFECT]
  - While executing [FADER]
  - [SMTH SLW REC]

### The recording angle differs depending on the POWER switch setting position.

- The recording angle when the POWER switch is set to CAMERA-MEMORY is wider than when it is set to CAMERA-TAPE.

### You cannot record a smooth transition on a tape from the last recorded scene to the next.

- Perform END SEARCH (p. 35).
- Do not remove the cassette (The picture will be recorded continuously without a break even when you turn the power off).
- Do not record pictures in the HDV and DV formats on the same tape.
- Do not record pictures in SP mode and LP mode on the same tape. **DV**
- Avoid stopping then recording a movie in the LP mode. **DV**
- When [QUICK REC] is set to [ON], you cannot record a smooth transition (p. 66). **HDV1080i**

---

**The shutter sound is not heard when you record a still image.**

- Set [BEEP] to [ON] (p. 65).

---

**The flash does not work.**

- You cannot use the flash during tape recording.
- When attaching a conversion lens (optional) or a filter (optional) to your camcorder, it may block the flash of your camcorder. In this case, the flash light does not emit light.
- Even if auto flash or  (Auto redeye reduction) is selected, you cannot use the internal flash with:
  - [SPOTLIGHT], [SUNSET&MOON], and [LANDSCAPE] of [PROGRAM AE]
  - [SPOT METER]
- The power of the external flash (optional) is not turned on, or the flash is not attached correctly.

---

**[END SEARCH] does not work.**

- Do not eject the cassette after recording (p. 35).
- There is nothing recorded on the cassette.

---

**[END SEARCH] does not work correctly.**

- There is a blank section between recorded sections of the tape. This is not a malfunction.

## Adjusting the image during recording

Refer also to “Menu” (p. 97).

---

**The auto focus does not function.**

- Set [FOCUS] to [AUTO] (p. 50).
- The recording conditions are not suitable for auto focus. Adjust the focus manually (p. 50).

---

**[STEADYSHOT] does not function.**

- Set [STEADYSHOT] to [ON] (p. 53).
- While using [SMTH SLW REC], [STEADYSHOT] does not work.

---

**The BACK LIGHT function does not function.**

- In the following settings, the BACK LIGHT function is canceled.
  - [MANUAL] of [EXPOSURE]
  - [SPOT METER]
- The BACK LIGHT function does not work during Easy Handycam operation (p. 24).

---

**The [FLASH LEVEL] cannot be changed.**

- [FLASH LEVEL] (p. 51) cannot be changed during Easy Handycam operation.

## Troubleshooting (Continued)

---

### **[DIGITAL ZOOM] does not function.**

- [DIGITAL ZOOM] does not function when you set [TELE MACRO] to [ON].
- 

### **Tiny spots in white, red, blue, or green appear on the screen.**

- The spots appear when you are recording in [SLOW SHUTTR], [SUPER NS], or [COLOR SLOW S]. This is not a malfunction.
- 

### **The subjects passing by the frame might appear crooked.**

- This is called the focal plane phenomenon. This is not a malfunction. Because of the way the image device (CMOS sensor) reads out image signals, the subjects passing by the frame rapidly might appear crooked depending on the recording conditions.
- 

### **The color of the picture is not correctly displayed.**

- Deactivate the NightShot function (p. 29).
- 

### **The screen picture is bright, and the subject does not appear on the screen.**

- Cancel the BACK LIGHT function (p. 29).
  - Set the NIGHTSHOT switch (p. 29) to OFF.
- 

### **The screen picture is dark, and the subject does not appear on the screen.**

- Press and hold DISP/BATT INFO for a few seconds to turn on the backlight (p. 16).
- 

### **The picture appears too bright, or flickering or changes in color occurs.**

- This occurs when recording pictures under a fluorescent lamp, sodium lamp, or mercury lamp. Cancel [PROGRAM AE] to minimize this phenomena (p. 48).
- 

### **Black bands appear when you record a TV screen or computer screen.**

- Set [STEADYSHOT] to [OFF] (p. 53).
- 

## **Playback**

If you are playing back pictures stored on a “Memory Stick Duo,” refer also to the “Memory Stick Duo” section (p. 91).

---

### **You cannot play back tape.**

- Slide the POWER switch to turn on the PLAY/EDIT lamp.
  - Rewind the tape (p. 27).
- 

### **You cannot play back in reverse direction.**

- Reverse playback is not possible with the tape recorded in the HDV format.

---

**The pictures stored on a “Memory Stick Duo” are not played back in their correct size or aspect ratio.**

- Pictures recorded on other devices may not appear in their actual size. This is not a malfunction.

---

**Image data stored on a “Memory Stick Duo” cannot be played back.**

- You cannot see movies recorded with other camcorders on the “Memory Stick Duo.”
- Image data cannot be played back if you have modified file names or folders, or have edited the data on a computer (In this case, the file name flashes). This is not a malfunction (p. 111).
- Pictures recorded on other devices may not be played back. This is not a malfunction (p. 111).

---

**Horizontal lines appear on the picture. The displayed pictures are not clear or do not appear.**

- Clean the head using the cleaning cassette (optional) (p. 115).

---

**You cannot hear the sound recorded with 4CH MIC REC on another camcorder.  
DV**

- Adjust [ AUDIO MIX] (p. 62).

---

**Fine patterns flicker, diagonal lines look jagged.**

- Adjust [SHARPNESS] to the  (soften) side (p. 50).

---

**No sound or only a low sound is heard.**

- Set [MULTI-SOUND] to [STEREO] (p. 63).
- Turn up the volume (p. 27).
- Adjust [ AUDIO MIX] from the [ST2] (additional sound) side until the sound is heard appropriately (p. 62).
- If you are using an S VIDEO plug or component video plug, make sure the red and white plugs of the A/V connecting cable are also connected (p. 38).
- Pictures recorded using [SMTH SLW REC] do not have sounds.

---

**The picture or sound breaks off.**

- The tape was recorded in both of the HDV and DV formats. This is not a malfunction.

---

**The movies freeze for a while, or the sound breaks off.**

- This occurs if the tape or video head is dirty (p. 115).
- Use the Sony mini DV cassette.

### “---” is displayed on the screen.

- The tape you are playing was recorded without setting the date and time.
  - A blank section on the tape is being played.
  - The data code on a tape with a scratch or noise cannot be read.
- 

### Noises appear and **NTSC** or **60i** is displayed on the screen.

- The tape was recorded in a TV color system other than that of your camcorder (PAL). This is not a malfunction (p. 107).
- 

### Date Search does not work correctly.

- Be sure to record more than 2 minutes after the date changed. If one day's recording is too short, your camcorder may not accurately find the point where the recording date changes.
  - There is a blank section between recorded sections of the tape. This is not a malfunction.
- 

### No picture appears during **[END SEARCH]** or **Rec Review**.

- The tape was recorded in both HDV and DV formats. This is not a malfunction.
- 

### You cannot view the picture on the TV connected with the i.LINK cable.

- You cannot view the picture in the HD (high definition) quality on the TV which is not compatible with the HDV1080i specification (p. 38). Refer to the instruction manuals supplied with your TV.
  - Down convert the pictures recorded in HDV format and play back in DV format (SD image quality) (p. 64).
  - Play back pictures using another connecting cable (p. 38).
- 

### You cannot view the picture or hear the sound on the TV connected with the component video cable.

- Set **[COMPONENT]** on the  (STANDARD SET) menu according to the requirements of the connected device (p. 63).
  - When you are using the component video cable, make sure the red and white plugs of the A/V connecting cable are connected (p. 38).
- 

### You cannot view the picture or hear the sound on the TV connected with the HDMI cable.

- Pictures in the HDV format are not output from the HDMI OUT jack, if copyright protection signals are recorded in the pictures.
- DV format pictures input to the camcorder via i.LINK cable (p. 73) cannot be output.
- This occurs if you record on a tape in both HDV and DV formats. Disconnect and connect the HDMI cable, or slide the **POWER** switch to turn on your camcorder again.



---

**The picture appears distorted on the 4:3 TV.**

- This happens when viewing a picture recorded in the 16:9 (wide) mode on a 4:3 TV. Set [TV TYPE] on the  (STANDARD SET) menu (p. 64) and play back the picture.

---

**4ch-12b appears on the LCD screen.**

- This appears when you play back a tape recorded on other recording devices using a 4ch microphone (4CH MIC REC). This camcorder does not comply with the 4ch microphone recording standard.

## Remote Commander

**The supplied Remote Commander does not function.**

- Set [REMOTE CTRL] to [ON] (p. 65).
- Remove any obstructions between the Remote Commander and the remote sensor.
- Keep strong light sources, such as sunlight or overhead lighting, away from the remote sensor, otherwise the Remote Commander may not function properly.
- Insert a fresh battery in the compartment with its +/- terminals matching those of the compartment (p. 117).
- Remove the conversion lens (optional) as the remote sensor may be obstructed by it.

---

**Another VCR malfunctions when you use the supplied Remote Commander.**

- Select a commander mode other than VTR 2 for your VCR.
- Cover the sensor of your VCR with black paper.

## Menu

**Menu items are grayed out.**

- You cannot select grayed items in the current recording/playback situation.

---

** is not displayed.**

- During Easy Handycam operation, not all menu items are functional. Cancel Easy Handycam operation (p. 24).

---

**You cannot use [PROGRAM AE].**

- You cannot use [PROGRAM AE] together with:
  - NightShot
  - [OLD MOVIE] or [CINEMA EFFECT] of [D.EFFECT]
  - [COLOR SLOW S]
  - [TELE MACRO]

### You cannot use [SPOT METER].

- You cannot use [SPOT METER] together with:
    - NightShot
    - [CINEMA EFFECT] of [D.EFFECT]
    - [COLOR SLOW S]
  - If you set [PROGRAM AE], [SPOT METER] is automatically set to [AUTO].
- 

### You cannot use [EXPOSURE].

- You cannot use [EXPOSURE] together with:
    - NightShot
    - [COLOR SLOW S]
    - [CINEMA EFFECT] of [D.EFFECT]
  - If you set [PROGRAM AE], [EXPOSURE] is automatically set to [AUTO].
- 

### You cannot adjust [WHITE BAL.].

- You cannot adjust [WHITE BAL.] when you use NightShot.
- 

### You cannot adjust [SHARPNESS].

- You cannot adjust [SHARPNESS] with [CINEMA EFFECT] of [D.EFFECT].
- 

### [AE SHIFT] cannot be operated.

- You cannot use [AE SHIFT] together with:
    - [CINEMA EFFECT] of [D.EFFECT]
    - [MANUAL] of [EXPOSURE]
- 

### You cannot use [SPOT FOCUS].

- You cannot use [SPOT FOCUS] together with [PROGRAM AE].
- 

### You cannot use [TELE MACRO].

- You cannot use [TELE MACRO] together with:
    - [PROGRAM AE]
    - Tape recording
- 

### [COLOR SLOW S] does not operate correctly.

- [COLOR SLOW S] may not operate correctly in total darkness. Use NightShot or [SUPER NS].
  - You cannot use [COLOR SLOW S] together with:
    - [FADER]
    - [D.EFFECT]
    - [PROGRAM AE]
    - [MANUAL] of [EXPOSURE]
    - [SPOT METER]
    - NightShot
-

---

**[HISTOGRAM] is not displayed.**

- [HISTOGRAM] is not displayed while displaying the date and time.
-  indicator appears and [HISTOGRAM] is not displayed in the following.
  - While using [DIGITAL ZOOM]
  - While using [D.EFFECT]



---

**You cannot use [FADER].**

- You cannot use [FADER] together with:
  - [SELF-TIMER]
  - [SUPER NS]
  - [COLOR SLOW S]
  - [D.EFFECT]

---

**You cannot use [D.EFFECT].**

- You cannot use [D.EFFECT] together with:
  - [SUPER NS]
  - [COLOR SLOW S]
  - [FADER]
- You cannot use [OLD MOVIE] together with:
  - [PICT.EFFECT]
  - [PROGRAM AE]
  - When [ WIDE SELECT] of [DV SET] is set to [4:3]
- You cannot use [CINEMA EFFECT] together with:
  - [EXPOSURE] set to [MANUAL]
  - Other than 0 in [AE SHIFT]
  - [PICT.EFFECT]
  - When [ WIDE SELECT] of [DV SET] is set to [4:3]
  - [PROGRAM AE]
  - [SPOT METER]

---

**You cannot use [PICT.EFFECT].**

- You cannot use [PICT.EFFECT] together with [OLD MOVIE] or [CINEMA EFFECT] of [D.EFFECT].

---

**[SMTH SLW REC] does not function.**

- You cannot use [SMTH SLW REC] together with:
  - [SUPER NS]
  - [COLOR SLOW S]
  - [D.EFFECT]
  - [PICT.EFFECT]
- You cannot use [SMTH SLW REC] while performing END SEARCH.

### Dubbing/Editing/Connecting to other devices

#### Pictures from connected devices cannot be zoomed.

- You cannot zoom pictures from connected devices on your camcorder (p. 30).

---

#### Time code and other information appear on the display of the connected device.

- Set [DISP OUTPUT] to [LCD PANEL] while connected with an A/V connecting cable (p. 65).

---

#### You cannot dub correctly using the A/V connecting cable.

- You cannot input externally from a device connected with the A/V connecting cable.
- The A/V connecting cable is not connected properly.  
Make sure that the A/V connecting cable is connected to the input jack of the other device for dubbing a picture from your camcorder.

---

#### When connected using an i.LINK cable, no picture appears on the monitor screen during dubbing.

- Set [VCR HDV/DV] on the  (STANDARD SET) menu according to the requirements of the connected device (p. 61).

---

#### You cannot add sound to the recorded tape.

- You cannot add sound to the recorded tape on this unit.

---

#### You cannot dub correctly using the HDMI cable.

- You cannot dub pictures using the HDMI cable.

---

#### New sound added to a recorded tape on another camcorder is not heard. DV

- Adjust [ AUDIO MIX] from the [ST1] (original sound) side until the sound is heard appropriately (p. 62).

---

#### Still pictures cannot be dubbed from a tape to a “Memory Stick Duo.”

- You cannot record or a distorted picture may be recorded if the tape has been used repeatedly for recording.

## Connecting to a computer

### The computer does not recognize your camcorder.

- Disconnect the cable from the computer and camcorder, then connect it again securely.
- Disconnect USB devices other than the keyboard, the mouse, and the camcorder from the  (USB) jack on the computer.
- Disconnect the cable from the computer and camcorder, restart the computer, then connect them again correctly.

---

### You cannot monitor video that the camcorder is capturing.

- Disconnect the cable from the computer, turn on the camcorder, then connect it again.

---

### You cannot view the video recorded on a tape on the computer.

- Disconnect the cable from the computer, then connect it again.
- Connect the i.LINK cable because you cannot copy pictures with the USB cable.

---

### You cannot view still images recorded on a “Memory Stick Duo” on the computer screen.

- Insert a “Memory Stick Duo” in the correct direction, then push it all the way in.
- You cannot use an i.LINK cable. Connect the camcorder and the computer using the USB cable.
- Slide the POWER switch to turn on the PLAY/EDIT lamp on your camcorder and set [USB SELECT] to  Memory Stick] (p. 59).
- The computer does not recognize the “Memory Stick Duo” during camcorder operations such as tape playback or editing. Finish any camcorder operations and then connect the camcorder to the computer again.



---

### Your computer freezes.

- Set [VCR HDV/DV] of  (STANDARD SET) correctly according to the connected device.
- During the Easy Handycam operation, set the menu after canceling the Easy Handycam operation (p. 24).
- Disconnect the cable from your computer and camcorder. Reboot your computer, and connect your computer and camcorder following the steps in the correct order (p. 82).

---

### [Removable Disk] does not appear on the computer screen.

- Slide the POWER switch to turn on the PLAY/EDIT lamp, then set [USB SELECT] to  Memory Stick] (p. 59).
- Insert a “Memory Stick Duo” into your camcorder.
- Disconnect the USB device other than the keyboard, the mouse, and the camcorder from the  (USB) jack on the computer.
- The computer does not recognize the “Memory Stick Duo” during camcorder operations such as tape playback or editing. Finish camcorder operations and then connect the camcorder to the computer again.

### **You cannot copy images to the Windows computer. USB**

- Display pictures recorded on a “Memory Stick Duo” with the following procedures.
  - 1** Double-click [My Computer].
  - 2** Double-click the icon for the newly recognized drive [Removable Disk]. It may take some time until the drive is recognized.
  - 3** Double-click the desired image file.

# Warning indicators and messages

## Self-diagnosis display/Warning indicators

If indicators appear on the LCD screen or in the viewfinder, check the following. Some symptoms you can fix by yourself. If the problem persists even after you have tried a couple of times, contact your Sony dealer or local authorized Sony service facility.

### C:(or E:) □□:□□ (Self-diagnosis display)

#### C:04:□□

- The battery pack is not an “InfoLITHIUM” battery pack. Use an “InfoLITHIUM” battery pack (p. 112).
- Connect the DC plug of the AC Adaptor to the DC IN jack of your camcorder securely (p. 11).

#### C:21:□□

- Moisture condensation has occurred. Remove the cassette and leave your camcorder for at least 1 hour, then re-insert the cassette (p. 115).

#### C:22:□□

- Clean the head using a cleaning cassette (optional) (p. 115).

#### C:31:□□ / C:32:□□

- Symptoms that are not described above have occurred. Remove and insert the cassette, then operate your camcorder again. Do not perform this procedure if moisture condensation has occurred (p. 115).
- Remove the power source. Reconnect it and operate your camcorder again.
- Change the cassette. Press RESET (p. 31), and operate your camcorder again.

#### E:61:□□ / E:62:□□ / E:91:□□

- Contact your Sony dealer or local authorized Sony service facility. Inform them of the 5-digit code, which starts from “E.”

### 101-1001(Warning indicator pertaining to files)

- The file is damaged.
- The file is unreadable (p. 110).

### (Battery level warning)

- The battery pack is nearly used up.
- Depending on the operating environment, or battery conditions,  may flash, even if there are approximately 5 to 10 minutes remaining.

### (Moisture condensation warning)\*

- Eject the cassette, remove the power source, and then leave it for about 1 hour with the cassette lid open (p. 115).

### (Warning indicator pertaining to “Memory Stick Duo”)

- A “Memory Stick Duo” is not inserted (p. 20).

### (Warning indicators pertaining to “Memory Stick Duo” formatting)\*

- The “Memory Stick Duo” is damaged.
- The “Memory Stick Duo” is not formatted correctly (p. 56, 110).

### (Warning indicator pertaining to incompatible “Memory Stick Duo”)\*

- An incompatible “Memory Stick Duo” is inserted (p. 110).

## Warning indicators and messages (Continued)

---

### (Warning indicators pertaining to the tape)

#### **Slow flashing:**

- There is less than 5 minutes remaining on the tape.
- No cassette is inserted.\*
- The write-protect tab on the cassette is set to lock (p. 108).\*

#### **Fast flashing:**

- The tape has run out.\*

---

### (Eject cassette warning)\*

#### **Slow flashing:**

- The write-protect tab on the cassette is set to lock (p. 108).

#### **Fast flashing:**

- Moisture condensation has occurred (p. 115).
- The self-diagnosis display code is displayed (p. 103).

---

### (Warning indicator pertaining to image deletion)\*

- The image is protected (p. 77).

---

### (Warning indicator pertaining to the write-protect of the “Memory Stick Duo”)\*

- The write-protect tab on the “Memory Stick Duo” is set to lock (p. 110).

---

### (Warning indicator pertaining to the flash)

#### **Slow flashing:**

- Still charging

#### **Fast flashing:**

- The self-diagnosis display code is displayed (p. 103).\*
- There is something wrong with the flash.

---

### (Warning indicator pertaining to camera-shake warning)





- The amount of lights is not sufficient, so camera-shake easily occurs. Use the flash.
- The camcorder is unsteady, so camera-shake easily occurs. Hold the camcorder steady with both hands and shoot the image. However, note that the camera-shake warning indicator does not disappear.

---

\* You hear a melody when the warning indicators appear on the screen (p. 65).

## Description of warning messages

If messages appear on the screen, follow the instructions.

- When  is displayed, the message can be turned into  by touching . Touch  to display the message again.

## Battery/Power

---

**Use the “InfoLITHIUM” battery pack**  
(p. 112)

---

**Use new AC adapter or reinsert.**  
(p. 14)

---

**Battery level is low.**

- Change the battery (p. 11, 112).

---

**Old battery. Use a new one.** (p. 112)

---

** Re-attach the power source.** (p. 11)



## ■ Moisture condensation

 **Moisture condensation. Eject the cassette** (p. 115)



 **Moisture condensation. Turn off for 1H.** (p. 115)

## ■ Cassette/Tape

 **Insert a cassette.** (p. 20)

 **Reinsert the cassette.** (p. 20)

- Check if the cassette is damaged.

  **The tape is locked - check the tab.** (p. 108)

 **The tape has reached the end.** (p. 20, 27)

- Rewind or change the tape.

## ■ “Memory Stick Duo”

 **Insert a Memory Stick.** (p. 20)

 **Reinsert the Memory Stick.** (p. 20, 110)

- Reinsert the “Memory Stick Duo” a few times. If even then the indicator flashes, the “Memory Stick Duo” might be damaged. Try with another “Memory Stick Duo.”

**This is a read-only Memory Stick.**

- Insert a writable “Memory Stick Duo.”

 **Incompatible type of Memory Stick.**



- A type of “Memory Stick Duo” incompatible with your camcorder is inserted (p. 110).

 **This Memory Stick is not formatted correctly.**

- Check the format, then format the “Memory Stick Duo” as necessary (p. 56, 110).

**Cannot record. The Memory Stick is full.**

- Delete unnecessary images (p. 76).

  **The Memory Stick is locked. Check the tab.** (p. 110)

**Cannot playback. Reinsert the Memory Stick.** (p. 20)

**Cannot record. Reinsert the Memory Stick.** (p. 20)

**No file.**

- No file is recorded or there is no readable file on the “Memory Stick Duo.”

**Memory Stick folders are full.**

- You cannot create folders exceeding 999MSDCF. You cannot delete created folders using your camcorder.
- You will have to format the “Memory Stick Duo” (p. 56), or delete them using your computer.

**Cannot record still images on Memory Stick.** (p. 110)

## ■ Dual Rec

**No more still pictures during movie recording.**

- You pressed PHOTO after taking the maximum storable still images (up to 3 images can be stored) (p. 28).

---

### Cannot save still picture.

- Do not eject “Memory Stick Duo” while still images are being stored onto it (p. 28).

### ■ PictBridge compliant printer

---

#### Check the connected device.

- Switch off the printer and switch it on again, then disconnect the USB cable and reconnect it.

---

#### Connect the camcorder to a PictBridge compatible printer.

- Switch off the printer and switch it on again, then disconnect the USB cable and reconnect it.

---

#### Error. Cancel the task.

- Check the printer.

---

#### Cannot print. Check the printer.

- Switch off the printer and switch it on again, then disconnect the USB cable and reconnect it.

### ■ Flash

---

#### Charging... Cannot record still images.

- You are trying to record a still image while charging the flash (optional).

---

#### Lens accessory attached. Cannot use flash. (p. 29)

### ■ Lens cover

---

#### Lens cover not fully open. Turn power off then on. (p. 15)

---

#### Lens cover is not closed. Turn the power off once. (p. 15)

### ■ Others

---

#### Cannot record due to copyright protection. (p. 108)

---

#### Change to correct tape format.

- The pictures cannot be played back because of an incompatible format.

---

#### No output image in “VCR HDV/DV”. Change format.

- Stop playback or signal input, or change the [VCR HDV/DV] setting (p. 61).

---

#### ⊗ Dirty video head. Use a cleaning cassette. (p. 115)

---

#### Cannot start Easy Handycam. (p. 88)

---

#### Cannot cancel Easy Handycam. (p. 88)

---

#### For audio, connect red and white plug on AV cable. (p. 38)

# Using your camcorder abroad

## Power supply

You can use your camcorder in any country/region using the AC Adaptor supplied with your camcorder within the AC 100 V to 240 V, 50/60 Hz range.

## On TV color systems

Your camcorder is PAL system, so its picture can only be viewed on a PAL system TV with an AUDIO/VIDEO input jack.

System	Used in
PAL	Australia, Austria, Belgium, China, Czech Republic, Denmark, Finland, Germany, Holland, Hong Kong, Hungary, Italy, Kuwait, Malaysia, New Zealand, Norway, Poland, Portugal, Singapore, Slovak Republic, Spain, Sweden, Switzerland, Thailand, United Kingdom, etc.
PAL - M	Brazil
PAL - N	Argentina, Paraguay, Uruguay.
SECAM	Bulgaria, France, Guiana, Iran, Iraq, Monaco, Russia, Ukraine, etc.
NTSC	Bahama Islands, Bolivia, Canada, Central America, Chile, Colombia, Ecuador, Guyana, Jamaica, Japan, Korea, Mexico, Peru, Surinam, Taiwan, the Philippines, the U.S.A., Venezuela, etc.

## Viewing HDV format pictures recorded in HDV format HDV1080i

You need an HDV1080i compatible TV (or monitor) with a component jack and AUDIO/VIDEO input jack. A component video cable and A/V connecting cable are also needed.

## Viewing DV format pictures recorded in DV format DV

You need a TV with the AUDIO/VIDEO input jack. A connecting cable is also needed.

## Simple setting of the clock by time difference

You can easily set the clock to local time abroad by the time difference you are in. Select [WORLD TIME] in the  (TIME/LANGU.) menu, then set the time difference (p. 66).

# Usable cassette tapes

Your camcorder is capable of recording in both HDV and DV formats.

You can use mini DV format cassettes only.

Use a cassette with the <sup>Mini</sup>DV mark.

Your camcorder is not compatible with cassettes with Cassette Memory.

## What is the HDV format?

The HDV format is a video format developed to record and play back digital high definition (HD) video signals on a DV cassette.

Your camcorder adopts the Interlace mode with 1,080 effective scan lines of screen ruling (1080i, number of pixels 1,440 × 1,080 dots).

The video bit rate for recording is about 25 Mbps.

i.LINK is adopted for the digital interface, enabling a digital connection with an HDV compatible TV or computer.

- HDV signals are compressed in MPEG2 format, which is adopted in BS (broadcast satellite) digital, terrestrial digital HDTV broadcastings, in Blu-ray Disc recorders, etc.

## Playback

- Your camcorder can play back pictures in both the DV format and HDV1080i specification.
- Your camcorder can play back pictures recorded in the HDV 720/30p format, but cannot output it from the  HDV/DV Interface (i.LINK).

## To prevent a blank section from being created on the tape

Go to the end of the recorded section using END SEARCH (p. 35) before you begin the next recording when you have played back the tape.

## Copyright signal

### ■ When you play back

If the cassette you play back on your camcorder contains copyright signals, you cannot copy it to a tape in another video camera connected to your camcorder.

### ■ When you record

You cannot record software on your camcorder that contains copyright control signals for copyright protection of software. [Cannot record due to copyright protection.] appears on the LCD screen, or on the viewfinder if you try to record such software. Your camcorder does not record copyright control signals on the tape when it records.

## Notes on use

### ■ When not using your camcorder for a long time

Remove the cassette and store it.

### ■ To prevent accidental erasure

Slide the write-protect tab on the cassette to set it to SAVE.



REC: The cassette can be recorded.

SAVE: The cassette cannot be recorded (write-protected).



### ■ When labeling the cassette

Be sure to place the label only on the locations shown in the following illustration so as not to cause a malfunction of your camcorder.

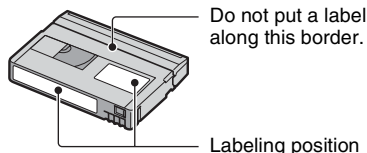

### ■ After using the cassette

Rewind the tape to the beginning to avoid distortion of the picture or the sound. The cassette should then be put in its case, and stored in an upright position.

### ■ When cleaning the gold-plated connector

Generally, clean the gold-plated connector on a cassette with a cotton-wool swab after every 10 times it has been ejected. If the gold-plated connector on the cassette is dirty or dusty, the remaining tape indicator may not show correctly.

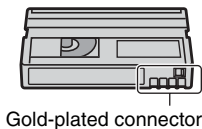

## On Sony HDV1080i compliant TVs HDV1080i

An HDV format compatible TV with the component input jack is required to view playback pictures recorded in the HDV format. See the table below for the main 2005/2006 models.

### Sony HDV1080i compatible TV models

KLV-S19A10U, KLV-S19A10E,  
KDL-S23A12U, KDL-S23A11E,  
KLV-S23A10E, KDL-S26A12U,  
KDL-S26A11E, KLV-S26A10E,  
KDL-S32A12U, KDL-S32A11E,  
KLV-S32A10E, KDL-S40A12U,  
KDL-S40A11E, KLV-S40A10E,  
KDL-V26A12U, KDL-V26A11E,  
KLV-V26A10E, KDL-V32A12U,  
KDL-V32A11E, KLV-V32A10E,  
KDL-V40A12U, KDL-V40A11E,  
KLV-V40A10E, KDL-W40A12U,  
KDL-W40A11E, KLV-W40A10E,  
KDE-V42A12U, KE-V42A10E,  
KDE-W50A12U, KDE-W50A11E,  
KE-W50A10E, KV-DB29M91,  
KV-DB29M98, KDF-E50A11E,  
KDF-E42A11E, KDF-E50A12U,  
KDF-E42A12U, KLV-V40A10,  
KLV-V32A10, KLV-V26A10, KLV-S40A10,  
KLV-S32A10, KLV-S26A10, KLV-S23A10,  
KDE-W50A10, KV-DA29M54,  
KV-DA34M54, KV-DA322M64,  
KV-DA322M66, KV-DB29M81,  
KV-DB29M61, KV-DB29M90,  
KV-DB29M60, KV-DB29M80,  
KV-DB29M50, KV-DB29M30,  
KV-DB34M81, KV-DB34M61,  
KV-DC29M80, KV-DC34M80, KP-FR43M91,  
KP-FR43M31, KP-FR43M90, KP-FR53M96,  
KP-FR53M94, KS-R60A10, KS-R50A10,  
KF-E50A10, KF-E42A10, etc.

As of 1st of February, 2006 (including models on sale in the near future)

- Some models are not available, depending on the country or region.

# About the “Memory Stick”

A “Memory Stick” is a compact, portable IC recording medium with a data capacity that exceeds the capacity of a floppy disk. You can use only a “Memory Stick Duo,” which is about the half size of a standard “Memory Stick” in your camcorder. However, appearance on the list below does not guarantee the operation of all types of “Memory Stick Duo” in your camcorder.

Types of “Memory Stick”	Recording/ Playback
“Memory Stick” (without MagicGate)	–
“Memory Stick Duo” <sup>*1</sup> (without MagicGate)	○
“MagicGate Memory Stick”	–
“Memory Stick Duo” <sup>*1</sup> (with MagicGate)	○ <sup>*2*3</sup>
“MagicGate Memory Stick Duo” <sup>*1</sup>	○ <sup>*3</sup>
“Memory Stick PRO”	–
“Memory Stick PRO Duo” <sup>*1</sup>	○ <sup>*2*3</sup>

<sup>\*1</sup> A “Memory Stick Duo” is about half the size of a standard “Memory Stick.”

<sup>\*2</sup> The types of “Memory Stick” that support high speed data transfer. The speed of data transfer varies depending on the device to be used.

<sup>\*3</sup> “MagicGate” is a copyright protection technology that records and transfers the contents in an encrypted format. Note that data that uses “MagicGate” technology cannot be recorded or played on your camcorder.

- Still image format: Your camcorder compresses and records image data in the JPEG (Joint Photographic Experts Group) format. The file extension is “.JPG.”
- File names of still images:
  - 101- 0001: This file name appears on the screen of your camcorder.
  - DSC00001.JPG: This file name appears on the display of a computer.
- A “Memory Stick Duo” formatted by a computer (Windows OS/Mac OS) does not have guaranteed compatibility with your camcorder.

- Data read/write speed may vary depending on the combination of the “Memory Stick” and “Memory Stick” compliant product you use.

## On a “Memory Stick Duo” with a write-protect tab

You can prevent accidental erasure of images when you slide the write-protect tab on the “Memory Stick Duo” with a small tapered object, to the write-protect position.

## Notes on use

Damaged or lost image data will not be compensated for, and may occur in the following cases:

- If you eject the “Memory Stick Duo,” turn the power off on your camcorder, or remove the battery pack for replacement while your camcorder is reading or writing image files on the “Memory Stick Duo” (while the access lamp is lit or flashing).
- If you use the “Memory Stick Duo” near magnets or magnetic fields.

It is recommended you make a back-up of important data on the hard disk of a computer.

## ■ On handling a “Memory Stick”

Keep the following in mind when handling a “Memory Stick Duo.”

- Be careful not to apply excessive force when writing on a memo area on a “Memory Stick Duo.”
- Do not attach a label or the like on a “Memory Stick Duo” or a Memory Stick Duo adaptor.
- When you carry or store a “Memory Stick Duo,” put it in its case.
- Do not touch, or allow metallic objects to come into contact with the terminals.
- Do not bend, drop or apply strong force to the “Memory Stick Duo.”
- Do not disassemble or modify the “Memory Stick Duo.”
- Do not let the “Memory Stick Duo” get wet.
- Be careful to keep “Memory Stick Duo” media out of the reach of small children. There is danger that a child might swallow it.

- Do not insert anything other than a “Memory Stick Duo” into the “Memory Stick Duo” slot. Doing so may cause a malfunction.

### ■ On a location for use

Do not use or keep the “Memory Stick Duo” in the following locations.

- Places subject to extremely high temperature, such as a car parked outside in the summer.
- Places under direct sunlight.
- Places with extremely high humidity or subject to corrosive gases.

### ■ On the Memory Stick Duo adaptor

After inserting a “Memory Stick Duo” into the Memory Stick Duo adaptor, you can use it with a standard “Memory Stick” compliant device.

- When using a “Memory Stick Duo” with a “Memory Stick” compliant device, be sure to insert the “Memory Stick Duo” into a Memory Stick Duo adaptor.
- When inserting a “Memory Stick Duo” into a Memory Stick Duo adaptor, make sure the “Memory Stick Duo” is inserted facing in the correct direction, then insert it all the way in. Note that improper use may cause a malfunction. Also, if you force the “Memory Stick Duo” into the Memory Stick Duo adaptor in the wrong direction, it may be damaged.
- Do not insert a Memory Stick Duo adaptor without a “Memory Stick Duo” attached. Doing so may result in malfunctions of the unit.

### ■ On a “Memory Stick PRO Duo”

- The maximum memory capacity of a “Memory Stick PRO Duo” that can be used on your camcorder is 2 GB.

## On image data compatibility

- Image data files recorded on a “Memory Stick Duo” by your camcorder conform to the “Design rule for Camera File system” universal standard established by the JEITA (Japan Electronics and Information Technology Industries Association).
- On your camcorder, you cannot play back still images recorded on other devices (DCR-TRV900E or DSC-D700/D770) that do not conform to the universal standard. (These models are not sold in some regions.)
- If you cannot use a “Memory Stick Duo” that has been used with another device, format it with your camcorder (p. 56). Note that formatting erases all information on the “Memory Stick Duo.”
- You may not be able to play back images with your camcorder:
  - When playing back image data modified on your computer.
  - When playing back image data recorded with other devices.

# About the “InfoLITHIUM” battery pack

This unit is compatible with an “InfoLITHIUM” battery pack (P series). Your camcorder operates only with an “InfoLITHIUM” battery pack. “InfoLITHIUM” P series battery packs have the  mark.

## What is an “InfoLITHIUM” battery pack?

An “InfoLITHIUM” battery pack is a lithium-ion battery pack that has functions for communicating information related to operating conditions between your camcorder and an optional AC Adaptor/charger.

The “InfoLITHIUM” battery pack calculates the power consumption according to the operating conditions of your camcorder, and displays the remaining battery time in minutes.

With an AC Adaptor/charger, the remaining battery time and charging time appear.

## To charge the battery pack

- Be sure to charge the battery pack before you start using your camcorder.
- We recommend charging the battery pack in an ambient temperature of between 10 °C to 30 °C (50 °F to 86 °F) until the CHG (charge) lamp turns off. If you charge the battery pack outside of this temperature range, you may not be able to charge it efficiently.
- After charging is complete, disconnect the cable from the DC IN jack on your camcorder or remove the battery pack.

## To use the battery pack effectively

- Battery pack performance decreases when the surrounding temperature is 10 °C (50 °F) or below, and the length of time you can use the battery pack becomes shorter. In that case, do one of the following to use the battery pack for a longer time.
  - Put the battery pack in a pocket to warm it up, and insert it in your camcorder right before you start taking shots.
  - Use a large capacity battery pack: NP-FP71/FP90 (optional).

- Frequent use of the LCD screen or a frequent playback, fast forward or rewind operation wears out the battery pack faster. We recommend using a large capacity battery pack: NP-FP71/FP90.
- Be sure to set the POWER switch to OFF (CHG) when not recording or playing back on your camcorder. The battery pack is also consumed when your camcorder is in recording standby or playback pause.
- Have spare battery packs ready for two or three times the expected recording time, and make trial recordings before making the actual recording.
- Do not expose the battery pack to water. The battery pack is not water resistant.

## About the remaining battery time indicator

- When the power goes off even though the remaining battery time indicator indicates that the battery pack has enough power to operate, charge the battery pack fully again. Remaining battery time will be indicated correctly. Note, however, that the battery indication will not be restored if it is used in high temperatures for a long time, or if left in a fully charged state, or when the battery pack is frequently used. Use the remaining battery time indication as a rough guide only.
- The  mark that indicates low battery flashes even if there are still 5 to 10 minutes of battery time remaining, depending on the operating conditions or ambient temperature.

## About storage of the battery pack

- If the battery pack is not used for a long time, fully charge the battery pack and use it up on your camcorder once a year to maintain proper function. To store the battery pack, remove it from your camcorder and put it in a dry, cool place.
- To discharge the battery pack on your camcorder completely, set [A.SHUT OFF] to [NEVER] on the  (STANDARD SET) menu and leave your camcorder in tape recording standby until the power goes off (p. 66).



# About i.LINK

## About battery life

- Battery capacity decreases over time and through repeated use. If decreased usage time between charges becomes significant, it is probably time to replace it with a new one.
- Each battery's life is governed by storage, operating and environmental conditions.

The HDV/DV Interface on this unit is an i.LINK-compliant Interface. This section describes the i.LINK standard and its features.

## What is i.LINK?

i.LINK is a digital serial interface for transferring digital video, digital audio, and other data to other i.LINK-compatible devices. You can also control other devices using the i.LINK.

i.LINK-compatible devices can be connected using an i.LINK cable. Possible applications are operations and data transactions with various digital AV devices.

When two or more i.LINK-compatible devices are daisy-chained with the unit, operation becomes possible from any device in the chain. Note that operation method may vary, or data transactions may not be possible, depending on specifications and characteristics of the connected devices.

- Normally, only one device can be connected to this unit with an i.LINK cable. When connecting this unit to an HDV/DV compatible device having two or more  HDV/DV Interfaces, refer to the operating instructions of the device to be connected.
- i.LINK is a more familiar term for the IEEE 1394 data transport bus proposed by Sony, and is a trademark approved by many corporations.
- IEEE 1394 is an international standard standardized by the Institute of Electrical and Electronics Engineers.

## About the i.LINK Baud rate

i.LINK's maximum baud rate varies according to the device. There are 3 types.

S100 (approx. 100Mbps\*)

S200 (approx. 200Mbps)

S400 (approx. 400Mbps)

The baud rate is listed under "Specifications" in the operating instructions of each piece of equipment. It

is also indicated near the i.LINK interface on some devices.

The baud rate may differ from the indicated value when the unit is connected to a device with a different maximum baud rate.

### \* What is Mbps?

Mbps stands for “megabits per second,” or the amount of data that can be sent or received in one second. For example, a baud rate of 100 Mbps means that 100 megabits of data can be sent in one second.

### To use i.LINK functions on this unit

For details on how to dub when this unit is connected to other video devices having an i.LINK Interface, see page 70.

This unit can also be connected to other i.LINK-compatible devices made by Sony (e.g. a VAIO series personal computer) as well as to video devices.

Some i.LINK compatible video devices, such as Digital Televisions, DVD, MICROMV or HDV recorders/players are not compatible with this unit. Before connecting to other devices, be sure to confirm whether the device is compatible with an HDV/DV device or not. For details on precautions and compatible application software, refer also to the operating instructions for the device to be connected.

### About the required i.LINK cable

Use the Sony i.LINK 4-pin-to-4-pin cable (during HDV/DV dubbing).

# Maintenance and precautions

## On use and care



- Do not use or store the camcorder and accessories in the following locations.
  - Anywhere extremely hot or cold. Never leave them exposed to temperatures above 60 °C (140 °F), such as under direct sunlight, near heaters or in a car parked in the sun. They may malfunction or become deformed.
  - Near strong magnetic fields or mechanical vibration. The camcorder may malfunction.
  - Near strong radio waves or radiation. The camcorder may not be able to record properly.
  - Near AM receivers and video equipment. Noise may occur.
  - On a sandy beach or anywhere dusty. If sand or dust gets in your camcorder, it may malfunction. Sometimes this malfunction cannot be repaired.
  - Near windows or outdoors, where the LCD screen, the viewfinder, or the lens may be exposed to direct sunlight. This damages the inside of the viewfinder or the LCD screen.
  - Anywhere very humid.
- Operate your camcorder on DC 7.2 V (battery pack) or DC 8.4 V (AC Adaptor).
- For DC or AC operation, use the accessories recommended in these operating instructions.
- Do not let your camcorder get wet, for example, from rain or sea water. If your camcorder gets wet, it may malfunction. Sometimes this malfunction cannot be repaired.
- If any solid object or liquid gets inside the casing, unplug your camcorder and have it checked by a Sony dealer before operating it any further.
- Avoid rough handling, disassembling, modifying, physical shock, or impact such as hammering, dropping or stepping on the product. Be particularly careful of the lens.
- Keep the POWER switch setting to OFF (CHG) when you are not using your camcorder.
- Do not wrap your camcorder with a towel, for example, and operate it. Doing so might cause heat to build up inside.
- When disconnecting the mains lead, pull it by the plug and not the lead.
- Do not damage the mains lead such as by placing anything heavy on it.
- Keep metal contacts clean.

- Keep the Remote Commander and button-type battery out of children's reach. If the battery is accidentally swallowed, consult a doctor immediately.
- If the battery electrolytic liquid has leaked,
  - consult your local authorized Sony service facility.
  - wash off any liquid that may have contacted your skin.
  - if any liquid gets in your eyes, wash with plenty of water and consult a doctor.

### ■ When not using your camcorder for a long time



- Periodically turn on the camcorder and play a cassette for about 3 minutes.
- Use up the battery pack completely before storing it.

### Moisture condensation

If your camcorder is brought directly from a cold place to a warm place, moisture may condense inside your camcorder, on the surface of the tape, or on the lens. In this state, the tape may stick to the head drum and be damaged or your camcorder may not operate correctly. If there is moisture inside your camcorder, []  Moisture condensation. Eject the cassette) or [] Moisture condensation. Turn off for 1H.] appears. The indicator will not appear when the moisture condenses on the lens.

### ■ If moisture condensation has occurred

None of the functions except cassette ejection will work. Eject the cassette, turn off your camcorder, and leave it for about one hour with the cassette lid open. Your camcorder can be used again when both of the following conditions are met:

- The warning message does not appear when the power is turned on.
- Neither  or  flash when a cassette is inserted and video operation buttons are touched.

If moisture starts to condense, your camcorder sometimes cannot detect condensation. If this happens, the cassette is sometimes not ejected for 10 seconds after the cassette lid is opened. This is not a

malfunction. Do not close the cassette lid until the cassette is ejected.

### ■ Note on moisture condensation

Moisture may condense when you bring your camcorder from a cold place into a warm place (or vice versa) or when you use your camcorder in a humid place as shown below.

- When you bring your camcorder from a ski slope into a place warmed up by a heating device.
- When you bring your camcorder from an air conditioned car or room into a hot place outside.
- When you use your camcorder after a squall or a shower.
- When you use your camcorder in a hot and humid place.

### ■ How to avoid moisture condensation

When you bring your camcorder from a cold place into a warm place, put your camcorder in a plastic bag and seal it tightly. Remove the bag when the air temperature inside the plastic bag has reached the surrounding temperature (after about one hour).

### Video head

If you play back a tape recorded in HDV format, the image and sound may freeze for a while (about 0.5 seconds).

This occurs if the HDV signals cannot be recorded or played back correctly because of dirt on the tape or video head. Depending on the cassette, this fairly infrequently occurs even if the cassette is brand new or is not used a lot.

If this freezing point is created while playing back, you can solve this problem and see the pictures by rewinding after slightly forwarding. Such a freezing point cannot be recovered if it was created while recording.

To prevent such a problem, use the Sony mini DV cassette.

- If the following problem occurs, clean the video heads for 10 seconds with the Sony DVM-12CLD cleaning cassette (optional).

## Maintenance and precautions (Continued)

- Playback pictures do not move.
- Playback pictures do not appear.
- The sound breaks off.
- [  Dirty video head. Use a cleaning cassette.] appears on the screen during recording.
- The following phenomenon occurs in HDV format.



The playback screen pauses.



The playback screen goes blank.  
(Solid blue screen)

- The following phenomenon occurs in DV format.



Block-noise appears.



The playback screen goes blank.  
(Solid blue screen)

- The video heads will degrade after long use. If you cannot obtain a clear image even after using a cleaning cassette (optional), it might be because the video heads are worn out. Please contact your Sony dealer or local authorized Sony service facility to have the video heads replaced.

### LCD screen

- Do not exert excessive pressure on the LCD screen, as it may cause damage.
- If your camcorder is used in a cold place, a residual image may appear on the LCD screen. This is not a malfunction.
- While using your camcorder, the back of the LCD screen may heat up. This is not a malfunction.

### ■ To clean the LCD screen

If fingerprints or dust make the LCD screen dirty, it is recommended you use a soft cloth to clean it. When you use the LCD Cleaning Kit (optional), do not apply the cleaning liquid directly to the LCD screen. Use cleaning paper moistened with the liquid.

### ■ On adjustment of the LCD screen (CALIBRATION)

The buttons on the touch panel may not work correctly. If this happens, follow the procedure below. It is recommended you connect your camcorder to the wall socket using the supplied AC Adaptor during the operation.

- ① Slide the POWER switch to turn on the PLAY/EDIT lamp.
- ② Disconnect cables other than that of the AC Adaptor from your camcorder, then eject the cassette and “Memory Stick Duo” from your camcorder.
- ③ Touch [P-MENU] → [MENU] →  (STANDARD SET) → [CALIBRATION] → [OK].

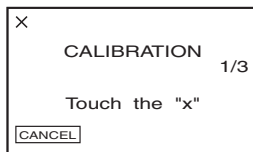

- ④ Touch the “x” displayed on the screen with the corner of the “Memory Stick Duo” or the like. The position of the “x” changes. Touch [CANCEL] to cancel.

If you did not press the right spot, start from step ④ again.

- You cannot calibrate the LCD screen if it is rotated.

## On handling the casing

- If the casing is soiled, clean the camcorder body with a soft cloth lightly moistened with water, and then wipe the casing with a dry soft cloth.
- Avoid the following to avoid damage to the finish.
  - Using chemicals such as thinner, benzene, alcohol, chemical cloths, repellent, insecticide and sunscreen.
  - Handling with above substances on your hands.
  - Leaving the casing in contact with rubber or vinyl objects for a long period of time.

## About care and storage of the lens

- Wipe the surface of the lens clean with a soft cloth in the following instances:
  - When there are fingerprints on the lens surface.
  - In hot or humid locations
  - When the lens is exposed to salty air such as at the seaside.
- Store in a well-ventilated location subject to little dirt or dust.
- To prevent mold, periodically clean the lens as described above. It is recommended that you operate your camcorder about once a month to keep it in optimum state for a long time.

## On charging the pre-installed rechargeable battery

Your camcorder has a pre-installed rechargeable battery to retain the date, time, and other settings even when the POWER switch is set to OFF (CHG). The pre-installed rechargeable battery is always charged while your camcorder is connected to the wall socket via the AC Adaptor or while the battery pack is inserted. The rechargeable battery will be fully discharged in about **3 months** if you do not use your camcorder at all without the AC Adaptor connected or the battery pack attached. Use your camcorder after charging the pre-installed rechargeable battery.

However, even if the pre-installed rechargeable battery is not charged, the

camcorder operation will not be affected as long as you are not recording the date.

### ■ Procedures

Connect your camcorder to a wall socket using the supplied AC Adaptor, and leave it with the POWER switch set to OFF (CHG) for more than 24 hours.

## To change the battery of the Remote Commander

- ① While pressing on the tab, inset your fingernail into the slit to pull out the battery case.
- ② Place a new battery with the + side facing up.
- ③ Insert the battery case back into the Remote Commander until it clicks.

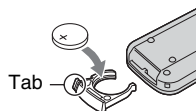

## WARNING

Battery may explode if mistreated. Do not recharge, disassemble or dispose of in fire.

- When the lithium battery becomes weak, the operating distance of the Remote Commander may shorten, or the Remote Commander may not function properly. In this case, replace the battery with a Sony CR2025 lithium battery. Use of another battery may present a risk of fire or explosion.

### To remove dust from inside the viewfinder

#### 1 Remove the eyecup.

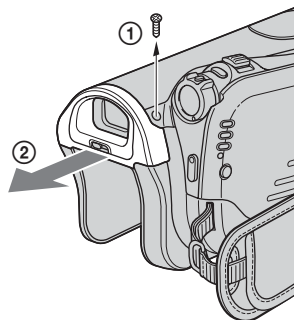
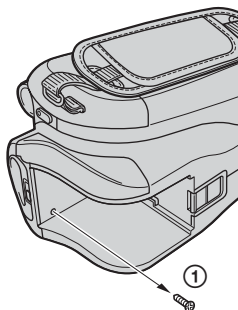

- 1 Remove the 2 screws beneath and on the right side of the finder using a screwdriver.
- 2 Slide the eyecup in the direction of the arrow to remove it.

#### 2 Remove the finder lens block.

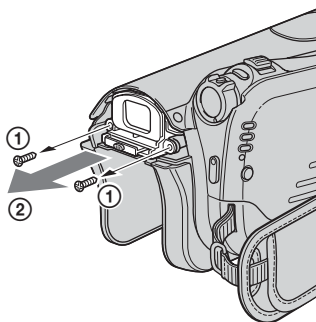

- 1 Remove the 2 screws on the lower left and right sides of the finder lens block using a screwdriver.
- 2 Slide the finder lens block in the direction of the arrow to remove it.

#### 3 Remove dust from the finder lens block with a camera lens blower, etc.

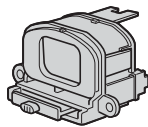

- The finder lens block is a precision part. You cannot disassemble it further.
- Do not touch the window or lens of the finder lens block.

# Specifications

- 
- 4** Remove dust from the inside area where the finder lens block was attached with a camera blower.

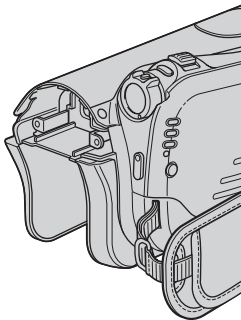

- You cannot disassemble your camcorder further because it is a precision component.

- 
- 5** Reassemble by following steps 1 to 4 in reverse.
- 

## ■ Caution

Do not remove any other screws. Remove only the screws that attach the finder lens block to the eyecup.

## System

### Video recording system (HDV)

2 rotary heads, Helical scanning system

### Video recording system (DV)

2 rotary heads, Helical scanning system

### Still image recording system

Exif Ver. 2.2\*1

### Audio recording system (HDV)

Rotary heads, MPEG-1 Audio Layer -2,

Quantization: 16 bits (Fs 48 kHz, stereo)

transfer rate: 384 kbps

### Audio recording system (DV)

Rotary heads, PCM system

Quantization: 12 bits (Fs 32 kHz, stereo 1, stereo 2), 16 bits (Fs 48 kHz, stereo)

### Video signal

PAL color, CCIR standards

1080/50i specification

### Usable cassette

Mini DV cassette with the <sup>Mini</sup>DV mark printed

### Tape speed (HDV)

Approx. 18.81 mm/s

### Tape speed (DV)

SP: Approx. 18.81 mm/s

LP: Approx. 12.56 mm/s

### Recording/playback time (HDV)

60 min (using a DVM60 cassette)

### Recording/playback time (DV)

SP: 60 min (using a DVM60 cassette)

LP: 90 min (using a DVM60 cassette)

### Fast forward/rewind time

Approx. 2 min 40 s (using a DVM60 cassette and rechargeable battery pack)

Approx. 1 min 45 s (using a DVM60 cassette and AC Adaptor)

### Viewfinder

Electric viewfinder (color)

## Specifications (Continued)

### Image device

5.9 mm (1/3 type) CMOS sensor  
Gross: Approx. 2 103 000 pixels  
Effective (movie, 4:3):  
1 076 000 pixels  
Effective (movie, 16:9):  
1 434 000 pixels  
Effective (still, 4:3):  
1 991 000 pixels  
Effective (still, 16:9):  
1 493 000 pixels

### Lens

Carl Zeiss Vario-Sonnar T\*

10 × (Optical), 20 ×, 80 × (Digital)

### Focal length

f=5.1 ~ 51 mm (7/32 ~ 2 1/8 in.)  
When converted to a 35 mm still camera  
In CAMERA-TAPE \*2 : 41.3 ~ 485 mm  
(1 11/16 ~ 19 1/8 in.) (16:9), 50.5 ~ 594 mm  
(2 ~ 23 1/2 in.) (4:3)  
In CAMERA-MEMORY : 37 ~ 370 mm  
(1 1/2 ~ 14 5/8 in.) (4:3), 40.4 ~ 404 mm  
(1 5/8 ~ 16 in.) (16:9)  
F1.8 ~ 2.9  
Filter diameter: 30 mm (1 3/16 in.)

### Color temperature

[AUTO], [ONE PUSH], [INDOOR]  
(3 200 K),  
[OUTDOOR] (5 800 K)

### Minimum illumination

5 lx (lux) (F 1.8)  
0 lx (lux) (during NightShot function)

\*1“Exif” is a file format for still images, established by the JEITA (Japan Electronics and Information Technology Industries Association). Files in this format can have additional information such as your camcorder’s setting information at the time of recording.

\*2The focal length figures are actual figures resulting from wide angle pixel read-out.

### Output connectors

#### Audio/Video output

10-pin connector  
Video signal: 1 Vp-p, 75 Ω (ohms), unbalanced  
Luminance signal: 1 Vp-p, 75 Ω (ohms), unbalanced  
Chrominance signal: 0.3 Vp-p, 75 Ω (ohms), unbalanced  
Audio signal: 327 mV (at load impedance 47 kΩ (kilohms)), Output impedance with less than 2.2 kΩ (kilohms)

#### COMPONENT OUT jack

Y: 1 Vp-p, 75Ω (ohms), unbalanced PB/PR, CB/CR: +/- 350 mVp-p

#### HDMI OUT jack

TypeA (19-pin)

### Input/Output connectors

#### LANC jack

Stereo mini-minijack (Ø 2.5 mm)

#### USB jack

mini-B

#### HDV/DV jack

i.LINK Interface (IEEE 1394, 4-pin connector S100)

### LCD screen

#### Picture

6.9 cm (2.7 type, aspect ratio 16:9)

#### Total dot number

211 200 (960 × 220)



## General

### Power requirements

- DC 7.2 V (battery pack)
- DC 8.4 V (AC Adaptor)

### Average power consumption

During camera recording using the viewfinder with normal brightness:

- HDV recording 3.9 W
- DV recording 3.8 W

During camera recording using the LCD with normal brightness:

- HDV recording 4.2 W
- DV recording 4.1 W

### Operating temperature

0 °C to + 40 °C (32 °F to 104 °F)

### Storage temperature

-20 °C to + 60 °C (-4 °F to + 140 °F)

### Dimensions (approx.)

82 × 78 × 139 mm  
(3 1/4 × 3 1/8 × 5 1/2 in.) (w/h/d)  
excluding the projecting parts

### Mass (approx.)

500 g (1 lb 1 oz) main unit only  
600 g (1 lb 5 oz) including the NP-FP60 rechargeable battery pack and DVM60 cassette.

### Supplied accessories

See page 10.

## AC Adaptor AC-L200

### Power requirements

AC 100 - 240 V, 50/60 Hz

### Current consumption

0.35 - 0.18 A

### Power consumption

18 W

### Output voltage

DC 8.4 V\*

### Operating temperature

0 °C to + 40 °C (32 °F to 104 °F)

### Storage temperature

-20 °C to + 60 °C (-4 °F to + 140 °F)

### Dimensions (approx.)

48 × 29 × 81 mm (1 15/16 × 1 3/16 × 3 1/4 in.) (w/h/d) excluding the projecting parts

### Mass (approx.)

170 g (6.0 oz) excluding the mains lead

\* See the label on the AC Adaptor for other specifications.

## Rechargeable battery pack (NP-FP60)

### Maximum output voltage

DC 8.4 V

### Output voltage

DC 7.2 V

### Capacity

7.2 Wh (1 000 mAh)

### Dimensions (approx.)

31.8 × 33.3 × 45.0 mm  
(1 5/16 × 1 5/16 × 1 13/16 in.) (w/h/d)

### Mass (approx.)

80 g (2.9 oz)

### Operating temperature

0 °C to + 40 °C (32 °F to 104 °F)

### Type

Lithium ion

Design and specifications are subject to change without notice.

### On trademarks

- “Handycam” and  are registered trademarks of Sony Corporation.
- “Memory Stick,”  “Memory Stick Duo,” “**MEMORY STICK DUO**,” “Memory Stick PRO Duo,” “**MEMORY STICK PRO DUO**,” “MagicGate,” “**MAGICGATE**,” “MagicGate Memory Stick” and “MagicGate Memory Stick Duo” are trademarks of Sony Corporation.
- “InfoLITHIUM” is a trademark of Sony Corporation.
- i.LINK and  are trademarks of Sony Corporation.
- Mini  Digital Video Cassette is a trademark.
- Microsoft, Windows, and Windows Media are trademarks or registered trademarks of U.S. Microsoft Corporation in the U.S. and other countries.
- Macintosh and Mac OS are trademarks of Apple Computer, Inc in the U.S. and other countries.
- HDV and the HDV logo are trademarks of Sony Corporation and Victor Company of Japan, Ltd.
- HDMI, **HDMI**, and High-Definition Multimedia Interface are trademarks or registered trademarks of HDMI Licensing Interface LLC.
- Pentium is a trademark or registered trademark of Intel Corporation.

All other product names mentioned herein may be the trademarks or registered trademarks of their respective companies. Furthermore, “™” and “®” are not mentioned in each case in this manual.



### Notes on the License

ANY USE OF THIS PRODUCT OTHER THAN CONSUMER PERSONAL USE IN ANY MANNER THAT COMPLIES WITH THE MPEG-2 STANDARD FOR ENCODING VIDEO INFORMATION FOR PACKAGED MEDIA IS EXPRESSLY PROHIBITED WITHOUT A LICENSE UNDER APPLICABLE PATENTS IN THE MPEG-2 PATENT PORTFOLIO, WHICH LICENSE IS AVAILABLE FROM MPEG LA, L.L.C., 250 STEELE STREET, SUITE 300, DENVER, COLORADO 80206.

# Identifying parts and controls

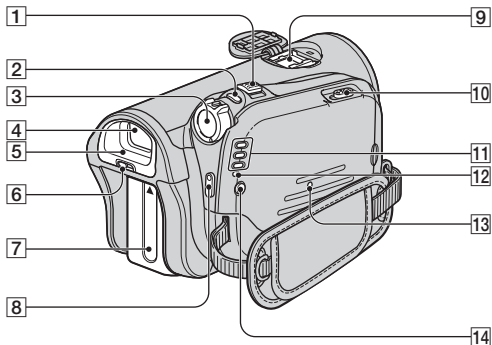
The numbers in ( ) are reference pages.



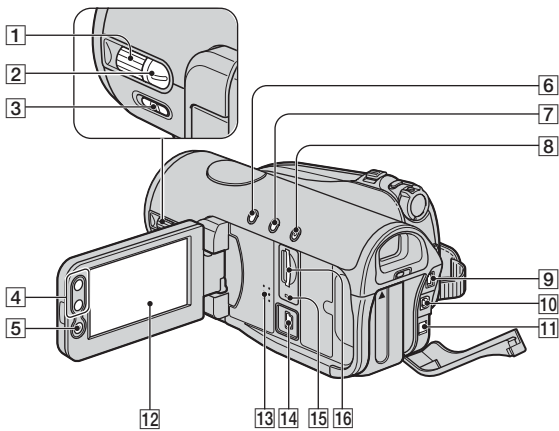

- 1 Power zoom lever (28)
- 2 PHOTO button (26)
- 3 POWER switch (15)
- 4 Viewfinder (16)
- 5 Eyecup (118)
- 6 Viewfinder lens adjustment lever (16)
- 7 Battery pack/battery terminal cover (11)
- 8 START/STOP button (26)
- 9 Active Interface Shoe  (79)
- 10  OPEN/EJECT lever (20)
- 11 CAMERA-TAPE, CAMERA-MEMORY, PLAY/EDIT mode lamps (15)
- 12 CHG (charge) lamp (11)
- 13 RESET button (31)
- 14  (flash) button (29)

## Identifying parts and controls (Continued)

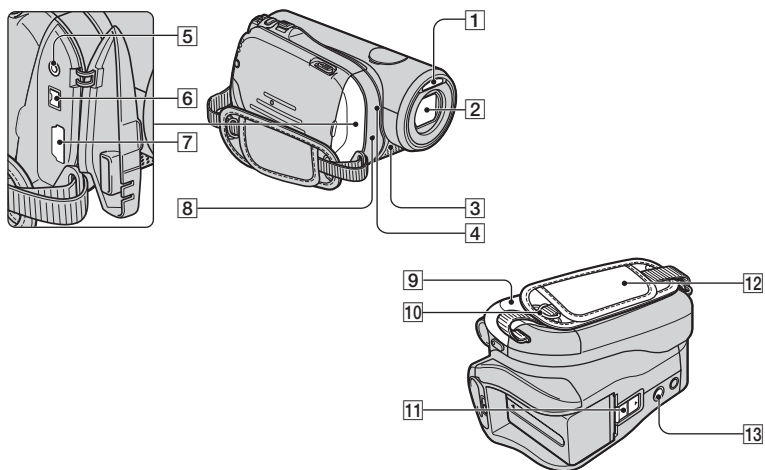

- 1** CAM CTRL dial (29)
- 2** MANUAL button (29)
- 3** NIGHTSHOT switch (29)
- 4** Zoom buttons (28)
- 5** START/STOP button (26)
- 6** BACK LIGHT button (29)
- 7** DISP/BATT INFO button (30)
- 8** EASY button (22)
- 9** COMPONENT OUT jack (79)
- 10** A/V OUT jack (79)
- 11** DC IN jack (79)
- 12** LCD screen/touch panel (3, 17)
- 13** Speaker (31)
- 14**  $\Psi$  (USB) jack (79)
- 15** Access lamp (20, 110)
- 16** “Memory Stick Duo” slot (20)



- 1** Flash
- 2** Lens (Carl Zeiss Lens) (4)
- 3** Microphone (31)
- 4** Camera recording lamp (31)
- 5**  LANC jack (79)
- 6**  HDV/DV Interface (i.LINK) (79)
- 7** HDMI OUT jack (79)
- 8** Remote sensor (31)
- 9** Cassette compartment lid (20)
- 10** Hooks for the Shoulder belt
- 11** BATT (battery release) lever (12)
- 12** Grip belt (15)
- 13** Tripod receptacle (30)

# Index

## Numeric

1080i/576i.....	63
12BIT.....	62
16BIT.....	62
21-pin adaptor.....	42
576i.....	63

## A

AC Adaptor.....	11
Access lamp.....	21
Active Interface Shoe.....	79
Adjusting exposure for back light.....	29, 93
AE SHIFT.....	50, 98
ALL ERASE.....	55
AUDIO MIX.....	62
AUDIO MODE.....	62
AUTO SHUTTER.....	50
A.SHUT OFF (Auto shut off).....	66
A/V connecting cable.....	39, 70
A/V OUT jack.....	39, 79

## B

BACK LIGHT.....	29, 93
BATT (battery release) lever.....	12
Battery	
BATT INFO (Battery info).....	30
Battery pack.....	11
Remaining battery.....	30
BEACH&SKI.....	48
BEEP.....	65
BLACK FADER.....	57
BURN DVD.....	85
Button-type lithium battery.....	117
B&W.....	58

## C

CALIBRATION.....	116
CAM CTRL dial.....	68
CAMERA COLOR.....	50
CAMERA DATA.....	65
CAMERA SET menu.....	48
Cassette.....	20, 108
Insert/Eject.....	20
Cassette compartment.....	20
Charging the battery.....	11
Battery pack.....	11
Pre-installed rechargeable battery.....	117
Charging time.....	13
CHG (charge) lamp.....	11
CINEMA EFFECT (Cinematic effect).....	58
Click to DVD.....	85
CLOCK SET.....	19
COLOR SLOW S (Color Slow Shutter).....	52, 98
COMPONENT.....	63
COMPONENT OUT jack.....	39, 79
Component video cable.....	39
Compression format.....	110
Connect	
Computer.....	80
TV.....	38
VCR.....	70
CONV.LENS.....	53

## D

DATA CODE.....	19, 64
Date search.....	37
DATE/TIME.....	19, 32, 65
DC IN jack.....	11
DC plug.....	11
Delete pictures.....	76
DEMO MODE.....	60, 88
DIAL SET.....	53

DIGITAL ZOOM.....	53, 94
DISP GUIDE (Display guide).....	17
DISP OUTPUT.....	65
Display indicators.....	32
DISP/BATT INFO button.....	16, 30
Down convert function.....	8
Dual Rec.....	28
Dubbing.....	70
DV format.....	61
DV SET.....	62
D.EFFECT (Digital effect).....	57, 99

## E

EASY button.....	22
Easy Handycam.....	22, 45
EDIT/PLAY menu.....	60
END SEARCH.....	35, 61
END SEARCH/Rec review display switch button.....	32
ERASE	
ALL ERASE.....	55
Pictures.....	76
EXPOSURE.....	49, 98
Eyecup.....	118

## F

FADER.....	57, 99
FILE NO. (File number).....	56
FINE.....	54
Fireworks.....	48
Flash button.....	29, 93
FLASH LEVEL.....	51, 93
FLASH SET.....	51
FLASH (Flash motion).....	58
FOCUS.....	50, 93

Folder	
NEW FOLDER .....	56
PB FOLDER	
(Playback folder) .....	56
REC FOLDER	
(Recording folder) .....	56
FORMAT .....	56, 110
Frame-by-frame Playback .....	60
Full charge .....	12

## G

Grip belt .....	15
GUIDEFRAAME .....	64

## H

HD (high definition) image	
quality .....	38
HDMI cable .....	39
HDMI OUT jack .....	39, 79
HDV format .....	61
HDV1080i .....	8, 62
HDV/DV Interface .....	39, 79
HISTOGRAM .....	52, 99
Holding the camcorder .....	15

## I

Icon .....	See Display indicators
Image delete button .....	33
Image protection .....	77
Image quality	
(QUALITY) .....	54
Image size	
(IMAGE SIZE) .....	54
Index screen .....	27
Index screen display button	
.....	33
Indicators .....	34
INDOOR .....	49
“InfoLITHIUM” battery pack	
.....	112
Initialize (Reset) .....	31
Insulation sheet .....	36
Internal microphone .....	31

INT.REC-STL	
(Interval photo recording) ....	59
i.LINK .....	113
i.LINK cable .....	40, 73, 83, 85
i.LINK CONV .....	38, 64

## J

Jack .....	79
Jack cover .....	79
JPEG .....	110

## L

Label .....	109
LANC jack .....	79
LANDSCAPE .....	48
LANGUAGE .....	66
LCD backlight .....	16, 90
LCD BL LEVEL	
(LCD back light level) .....	63
LCD BRIGHT .....	63
LCD COLOR .....	63
LCD PANEL .....	65
LCD panel .....	16
LCD BL LEVEL .....	63
LCD BRIGHT .....	63
LCD COLOR .....	63
LCD screen .....	16
LCD/VF SET .....	63
Lens cover .....	15, 26
Lid .....	20
LP (Long Play) .....	62

## M

Macintosh .....	80
Main sound .....	63
Mains lead .....	11
Maintenance .....	114
MANUAL button .....	68
MEMORY SET menu .....	54
Memory Stick .....	60
“Memory Stick” .....	110

“Memory Stick Duo” .....	20
FORMAT .....	56
Insert/Eject .....	20
Number of recordable	
pictures .....	54
Write-protect tab .....	110
Memory Stick Duo adaptor	
.....	111
“Memory Stick Duo” slot .....	21
Menu .....	44
CAMERA SET menu .....	48
EDIT/PLAY menu .....	60
MEMORY SET menu .....	54
Menu items .....	46
Personal Menu .....	44, 67
PICT.APPLI. menu .....	57
STANDARD SET menu	
.....	61
TIME/LANGU. menu .....	66
Using the menu .....	44
MENU ROTATE .....	65
Mirror mode .....	30
Moisture condensation .....	115
MONOTONE .....	57
MOSAIC .....	59
MOSAIC FADER .....	57
MULTI-SOUND .....	63

## N

NEG.ART .....	58
NEW FOLDER .....	56
NightShot .....	29
NIGHTSHOT switch .....	29
NS LIGHT	
(NightShot Light) .....	52
NTSC .....	107
Number of recordable pictures	
.....	54

## O

OLD MOVIE .....	58
ONE PUSH .....	49

## Index (Continued)

OPEN/EJECT lever .....20  
Operation confirmation beep  
..... See BEEP  
OUTDOOR .....49

## P

PAL .....96, 107  
PASTEL .....59  
PB FOLDER  
(Playback folder) .....56  
PB zoom .....30  
Personal Menu .....44, 67  
    Add .....67  
    Arrange the order .....68  
    Customize .....67  
    Delete .....67  
    Reset .....68  
    Use .....44  
Personal Menu button .....32  
PHOTO button .....23, 26, 36  
PictBridge .....77  
PictBridge PRINT .....77  
Picture Search .....27  
PICT.APPLI. menu (Picture  
Application menu) .....57  
PICT.EFFECT  
(Picture effect) .....58  
Playback .....27  
    Frame .....60  
    Reverse .....60  
    Slow .....60  
Playing time .....13  
PORTRAIT (Soft portrait) ...48  
POWER switch .....15  
Pre-installed rechargeable  
battery .....117  
Previous/Next image button  
.....33  
Print .....77  
Print mark .....76  
PROGRAM AE .....48, 97  
P.MENU .... See Personal Menu

## Q

QUALITY ..... 54  
QUICK REC ..... 66

## R

REC CTRL  
(Recording control) ..... 74  
REC FOLDER  
(Recording folder) ..... 56  
REC FORMAT ..... 62  
REC LAMP  
(Recording lamp) ..... 65  
REC lamp  
(Recording lamp) ..... 31  
REC MODE  
(Recording mode) ..... 62  
Rec review ..... 35  
Recording ..... 26  
Recording capacity ..... 32  
Recording time ..... 13  
REDEYE REDUC ..... 51  
REMAINING ..... 65  
Remaining battery ..... 32  
Remote Commander ..... 36  
REMOTE CTRL  
(Remote control) ..... 65  
Remote sensor ..... 31  
RESET button ..... 31  
Reversal Playback ..... 60

## S

S VIDEO cable ..... 41, 70  
S VIDEO jack ..... 38, 70  
SD (standard definition) image  
quality ..... 38  
Searching for the starting point  
..... 35  
Self-diagnosis display ..... 103  
SELF-TIMER ..... 52  
SEPIA ..... 58  
Setting the date and time ..... 19  
SHARPNESS ..... 50, 98

Shoulder belt .....30  
SKINTONE .....58  
Skip Scan .....27  
SLIDE SHOW .....57  
Slow Playback .....60  
SLOW SHUTTR  
(Slow shutter) ..... 58  
SMTH SLW REC .....59  
SOLARIZE .....58  
SP (Standard Play) .....62  
Speaker .....31  
Specifications ..... 119  
SPOT FOCUS .....50, 98  
SPOT METER  
(Flexible spot meter) .....48, 98  
SPOTLIGHT .....48  
STANDARD .....54  
STANDARD SET menu .....61  
START/STOP button .....22, 26  
STATUS CHECK .....64  
STEADYSHOT .....53, 93  
STEREO .....63  
STILL .....58  
Still image  
    Image size .....54  
    Quality .....54  
    Still image format .....110  
STILL SET .....54  
Sub sound .....63  
SUNSET&MOON .....48  
SUPER NS  
(Super NightShot) .....51  
System requirements .....80

## T

Tape counter .....32  
Tape playback select button  
.....33  
Tape ..... See Cassette  
TELE MACRO .....51, 98  
Telephoto .....28  
Time code .....32



TIME/LANGU. menu.....	66
Touch panel .....	17
Trademark.....	122
TRAIL .....	58
Transmitter.....	36
Tripod .....	30
TV .....	38
TV color systems .....	107
TV TYPE.....	64

## U

USB jack.....	79
USB SELECT.....	59
Using abroad.....	107

## V

VAR.SPD PB (Various speed playback) .....	60
VCR HDV/DV .....	61
VF B.LIGHT (Viewfinder brightness).....	63
Video control buttons .....	36
Video head.....	115
Video operation buttons.....	33
Viewfinder .....	16
Brightness.....	63
Viewfinder lens adjustment lever .....	16
VOLUME .....	63
Volume .....	27
V-OUT/PANEL.....	65

## W

Wall socket .....	11
Warning indicators.....	103
Warning messages .....	104
WB SHIFT (White Balance Shift) .....	50
WHITE BAL. (White balance).....	49, 98
WHITE FADER .....	57
Wide angle.....	28

WIDE SELECT.....	62
Windows .....	80
WORLD TIME .....	66
Write-protect tab .....	108, 110

## Z

ZEBRA.....	52
Zero set memory .....	36
ZERO SET MEMORY button .....	36
Zoom.....	28
Zoom lever .....	28



