

Black and White Video Camera

Operating Instructions

Before operating the unit, please read this manual thoroughly and retain it for future reference.

Mode d'emploi

Avant de faire fonctionner cet appareil, lisez attentivement le présent mode d'emploi et conservez-le pour toute référence ultérieure.

Manual de instrucciones

Antes de utilizar la unidad, lea las instrucciones con atención y consérvelas para su consulta en el futuro.

Hyper HAD™ SPT-M124 SPT-M122CE/M124CE/M128CE

Sony Corporation © 1998 Printed in Japan

Owner's Record

The model and serial numbers are located on the bottom. Record these numbers in the spaces provided below. Refer to these numbers whenever you call upon your Sony dealer regarding this product.

Model No. _____ Serial No. _____

WARNING

To prevent fire or shock hazard, do not expose the unit to rain or moisture.

To avoid electrical shock, do not open the cabinet. Refer servicing to qualified personnel only.



NOTICE FOR THE SPT-M124
The graphical symbol is on the unit. This symbol is intended to alert the user to the presence of important operating and maintenance (servicing) instructions in the literature accompanying the appliance.

For the customers in the U.S.A. (SPT-M124 only)

This equipment has been tested and found to comply with the limits for a Class B digital device, pursuant to Part 15 of the FCC Rules. These limits are designed to provide reasonable protection against harmful interference in a residential installation. This equipment generates, uses, and can radiate radio frequency energy and, if not installed and used in accordance with the instructions, may cause harmful interference to radio communications. However, there is no guarantee that interference will not occur in a particular installation. If this equipment does cause harmful interference to radio or television reception, which can be determined by turning the equipment off and on, the user is encouraged to try to correct the interference by one or more of the following measures

English

Features

The SPT-M124/M122CE/M124CE/M128CE black and white video camera is designed for use in a monitoring system.

- High resolution and high sensitivity with a 1/3 inch Hyper HAD™ (Hyper Hole Accumulated Diode) CCD (Charge Coupled Device) for the image device
- CCD-IRIS function
- AGC (Automatic Gain Control)
- AC line lock (SPT-M124/M124CF/M128CF)
- Can be used with C or CS mount lenses
- Compatible with DC controlled or video signal controlled auto iris lenses
- LEVEL and BLC (Back Light Control) adjustment for various lighting conditions
- Isolated power circuit
- Hyper HAD™ is a registered trademark of Sony Corporation.

Notes on Use

Power supply

- The SPT-M124 must always be operated with a UL-listed 24 V AC, 60 Hz Class 2 power supply. In the U.S.A, use a power supply which is UL listed. In Canada, use a power supply which is CSA Certified.
- The SPT-M124CE must always be operated with a 24 V AC, 50 Hz power supply.
 - When connecting the transformer, be sure to connect each lead to the appropriate terminal. Wrong connection may cause malfunction and/or damage to the video camera.
 - Ground the unit or an irregular voltage may be generated in the AC power cord and may cause malfunction and/or damage to the video camera.
- The SPT-M128CE must always be operated with a 220 to 240 V AC, 50 Hz power supply.
- The SPT-M122CE must always be operated with a 12 V DC power supply.

Handling of the unit

Be careful not to spill water or other liquids on the unit, or to get combustible or metallic material inside the body. If used with foreign matter inside, the camera is liable to fail, or to be a cause of fire or electric shock.

Operating and storage locations

Avoid viewing a very bright object (such as light fittings) for an extended period. Avoid operating or storing the unit in the following locations.

- Extremely hot or cold places (operating temperature -10°C to $+50^{\circ}\text{C}$; 14°F to 122°F , however, we recommend that the unit be used within a temperature range of -5°C to $+40^{\circ}\text{C}$; 23°F to 104°F)
- Damp or dusty places
- Where it is exposed to rain
- Where it is subject to strong vibration
- Close to generators of powerful electromagnetic radiation such as radio or TV transmitters.

Handling of the lens

As the lens could be damaged if not attached properly, make sure to see the section "Suitable lenses" before attaching it.

Care of the unit

- Remove dust or dirt on the surface of the lens or CCD with a blower.
- Use a dry soft cloth to clean the body. If it is very dirty, use a cloth dampened with a small quantity of neutral detergent, then wipe dry.
- Avoid the use of volatile solvents such as thinners, alcohol, benzene, and insecticides. They may damage the surface finish and/or impair the operation of the camera.

In the event of any problems with the operation of the camera, contact your Sony service representative.

Location and Function of Parts

Top/Front/Side

Illustration A

- 1 Focal length adjustment ring and locking screw

Location and Function of Parts

Top/Front/Side

Illustration A

1 Focal length adjustment ring and locking screw

Use this ring to adjust the focal length (the distance between the lens mounting plane and the image plane).

Use the locking screw to lock the focal length.

2 Tripod adapter

The tripod adapter can be attached to either the top or bottom of the camera using the three attached screws (1/4" UNC-20).

(At the factory, the tripod adapter is attached on the top of SPT-M124, while it is on the bottom of SPT-M122CE/M124CE/M128CE.)

3 Auto iris lens selection switch (DC/VIDEO)

Switch for selecting the control signal for the auto iris lens.

DC: For auto iris lenses controlled by DC signals

VIDEO: For auto iris lenses controlled by video signals

Note

When the auto iris lens selection switch is set to VIDEO, "hunting" may occur. If this occurs, use the LEVEL L/H adjustment screw on the lens to change the incident light level. When adjusting the incident light level, set the ALC (Automatic Light Control) adjustment screw to AV.

4 Lens connector (4 pin socket)

Supplies power and control signals to an auto iris lens.

5 Lens mount

Use to mount an appropriate C-mount or a CS-mount lens. To attach a C-mount/CS-mount lens, turn the focal length adjustment ring to the appropriate position. The factory setting is CS mount.

Rear

B

6 V-PHASE adjustment screw (SPT-M124/M124CE/M128CE)

Use to adjust the vertical phase of cameras synchronized by line lock.

7 CCD-IRIS ON/OFF switch

When using a manual iris lens, set the CCD-IRIS switch to "ON" to automatically adjust the sensitivity according to the incident light conditions. When using an auto iris lens, set this switch to "OFF."

8 BLC (Back Light Control) adjustment screw

Use to compensate for backlight conditions when using a manual iris lens (when CCD IRIS ON/OFF switch is set to "ON") or a DC controlled auto iris lens.

Note

This screw cannot be used when a video signal controlled auto iris lens is mounted.

9 VIDEO OUT connector (BNC-type)

10 AC 24 V screw terminals (SPT-M124/M124CE)

Connect to an external power supply of AC 24 V.

DC 12 V screw terminals (SPT-M122CE)

Connect to an external power supply of DC 12 V.

11 LEVEL adjustment screw

Use to compensate for the video level when using a manual iris lens (when CCD-IRIS ON/OFF switch is set to "ON") or a DC controlled auto iris lens.

Note

This screw cannot be used when a video signal controlled auto iris lens is mounted.

12 Ground terminal (screw type) (SPT-M124/M124CE)

13 Power cable (SPT-M128CE)

Connect to an AC power supply of 220 V to 240 V.

Si vous avez un problème de fonctionnement avec la caméra, contactez votre représentant Sony.

Emplacement et fonction des composants

Dessus / Partie frontale / Côté

Illustration A

1 Bague de réglage de la mise au point et vis de blocage

Cette bague sert à régler la distance focale (la distance entre le plan de montage de l'objectif et le plan de l'image).

Servez-vous de la vis de blocage pour verrouiller la distance focale.

2 Adaptateur de trépied

L'adaptateur de trépied peut être fixé sur le dessus ou sur la base de la caméra à l'aide des trois vis installées (1/4" UNC-20).

(L'adaptateur de trépied est fixé en usine sur le dessus de la caméra SPT-M124 et sur la base des caméras SPT-M122CE/M124CE/M128CE.)

3 Sélecteur d'objectif à diaphragme automatique (DC/VIDEO)

Sert à sélectionner le signal de commande d'un objectif à diaphragme automatique.

DC: pour les objectifs à diaphragme automatique commandés par l'alimentation CC

VIDEO: pour les objectifs à diaphragme automatique commandés par des signaux vidéo

Remarque

Lorsque le sélecteur de l'objectif à diaphragme automatique est réglé sur VIDEO, un "balayage" peut se produire. Si c'est le cas, utilisez la vis de réglage LEVEL L/H de l'objectif pour modifier le niveau de lumière incidente. Lors du réglage du niveau de lumière incidente, réglez la vis de réglage ALC (réglage automatique de la lumière) sur AV.

4 Connecteur d'objectif (4 broches)

Transmet l'alimentation et les signaux de commande à un objectif à diaphragme automatique.

5 Monture de l'objectif

Sert à la fixation d'un objectif à monture C ou CS. Pour monter un objectif à monture C ou CS, tournez la bague de réglage de la distance focale sur la position appropriée. Le réglage par défaut est "CS".

Arrière

B

6 Vis de réglage V-PHASE (SPT-M124/M124CE/M128CE)

Sert au réglage de la phase verticale des caméras synchronisées par le verrouillage de ligne.

7 Commutateur CCD-IRIS ON/OFF

Lorsque vous utilisez un objectif à diaphragme manuel, réglez le commutateur CCD-IRIS sur "ON" pour régler automatiquement la sensibilité en fonction de la lumière incidente. Lorsque vous utilisez un objectif à diaphragme automatique, réglez ce commutateur sur "OFF".

8 Vis de réglage BLC (compensation de contre-jour)

Sert à compenser le contre-jour lorsque vous utilisez un objectif à diaphragme manuel (le commutateur CCD-IRIS ON/OFF est réglé sur "ON") ou un objectif à diaphragme automatique et commande CC.

Remarque

Cette vis de réglage ne peut être utilisée lorsqu'un objectif à diaphragme automatique commandé par signal vidéo est installé.

9 Connecteur VIDEO OUT (type BNC)

10 Bornes à vis AC IN 24 V CA (SPT-M124/M124CE)

Branchez sur une source d'alimentation externe de 24 V CA.

Bornes à vis DC IN 12 V (SPT-M122CE)

Branchez sur une source d'alimentation externe de 12 V CC.

11 Vis de réglage LEVEL

Sert à compenser le niveau vidéo lorsque vous utilisez un objectif à diaphragme manuel (le commutateur CCD-IRIS ON/OFF est réglé sur "ON") ou un objectif à diaphragme automatique et commande CC.

Remarque

Cette vis de réglage ne peut être utilisée lorsqu'un objectif à diaphragme automatique commandé par signal vidéo est installé.

12 Borne de masse (type à vis) (SPT-M124/M124CE)

emission limits.

AVERTISSEMENT

Afin d'éviter tout risque d'incendie ou d'électrocution, ne pas exposer cet appareil à la pluie ou à l'humidité.

Afin d'écartier tout risque d'électrocution, garder le coffret fermé. Ne confier l'entretien de l'appareil qu'à un personnel qualifié.

ADVERTENCIA

Para prevenir el riesgo de incendios o de electrocución, no exponga la unidad a la lluvia ni a la humedad.

Para evitar descargas eléctricas, no abra la unidad. En caso de avería, solicite el servicio de personal cualificado únicamente.

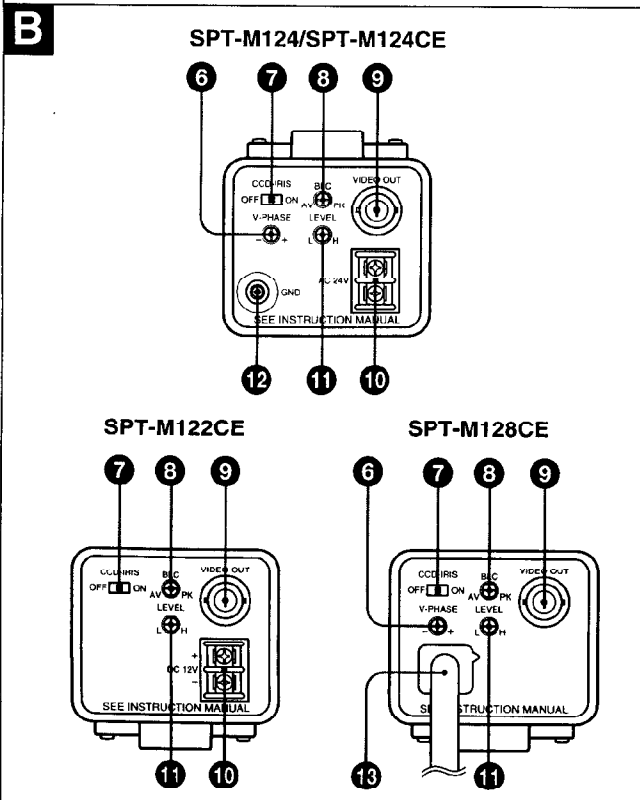
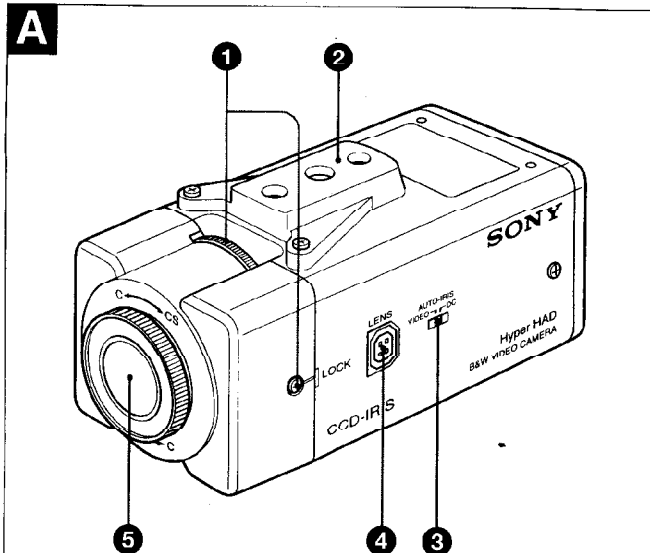

DC: For auto iris lenses controlled by DC signals
VIDEO: For auto iris lenses controlled by video signals

Note

When the auto iris lens selection switch is set to VIDEO, "hunting" may occur. If this occurs, use the LEVEL L/H adjustment screw on the lens to change the incident light level. When adjusting the incident light level, set the ALC (Automatic Light Control) adjustment screw to Av.

4 Lens connector (4 pin socket)

Supplies power and control signals to an auto iris lens.

5 Lens mount

Use to mount an appropriate C-mount or a CS-mount lens. To attach a C-mount/CS-mount lens, turn the focal length adjustment ring to the appropriate position. The factory setting is CS mount.

Rear

B

6 V-PHASE adjustment screw (SPT-M124/M124CE/M128CE)

Use to adjust the vertical phase of cameras synchronized by line lock.

7 CCD-IRIS ON/OFF switch

When using a manual iris lens, set the CCD-IRIS switch to "ON" to automatically adjust the sensitivity according to the incident light conditions. When using an auto iris lens, set this switch to "OFF."

8 BLC (Back Light Control) adjustment screw

Use to compensate for backlight conditions when using a manual iris lens (when CCD-IRIS ON/OFF switch is set to "ON") or a DC controlled auto iris lens.

Note

This screw cannot be used when a video signal controlled auto iris lens is mounted.

9 VIDEO OUT connector (BNC-type)

10 AC 24 V screw terminals (SPT-M124/M124CE)

Connect to an external power supply of AC 24 V.

DC 12 V screw terminals (SPT-M122CE)

Connect to an external power supply of DC 12 V.

11 LEVEL adjustment screw

Use to compensate for the video level when using a manual iris lens (when CCD-IRIS ON/OFF switch is set to "ON") or a DC controlled auto iris lens.

Note

This screw cannot be used when a video signal controlled auto iris lens is mounted.

12 Ground terminal (screw type) (SPT-M124/M124CE)

13 Power cable (SPT-M128CE)

Connect to an AC power supply of 220 V to 240 V.

9 mm or less
9 mm ou moins
9 mm o menos

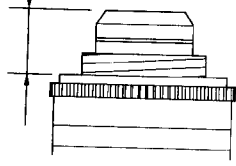

4 mm or less
4 mm ou moins
4 mm o menos

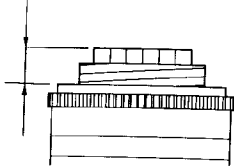

D

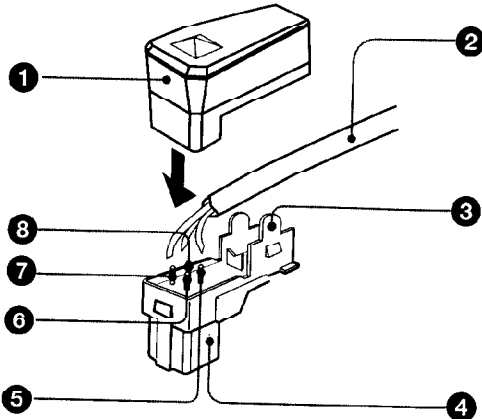

E

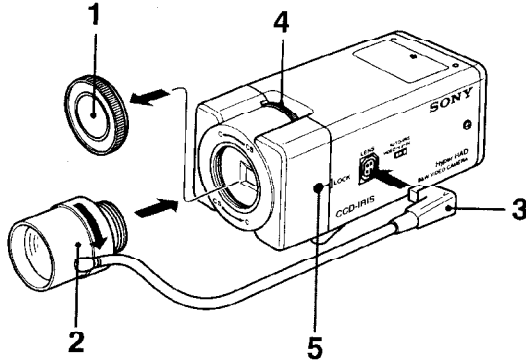

F

SPT-M124
SPT-M124CE

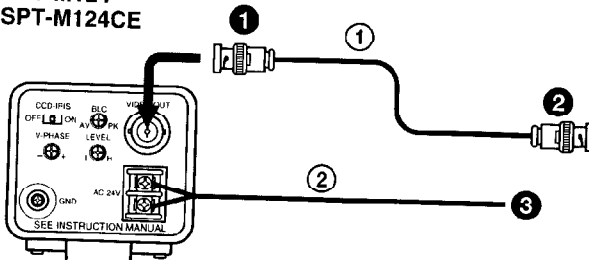

SPT-M128CE

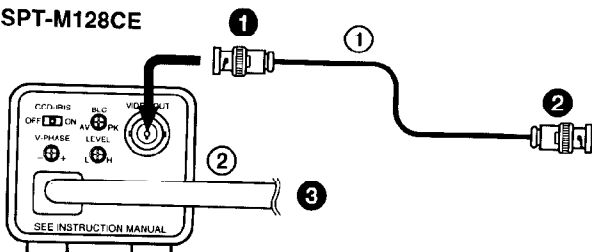

The lens must be either a C- or a CS-mount type of less than 1 kg. If protrusion behind the mounting surface must be within the limits as shown in illustration **C**.

Changing the plug on an auto iris lens cable **D**

The camera is supplied with a LENS connector for inserting the power control cable of an auto iris lens. Before connecting an auto iris lens, however, you first have to replace the lens cable plug with the one supplied with this camera. Replace as follows:

- 1 Detach the old plug from the lens cable.
- 2 Solder the wires to the pins of the new plug. (For cable pin assignment, refer to the instruction manual for the lens.)

1	Cover		
2	Lens cable (not supplied)		
3	Rib (if the cable is thick, cut this off.)		
4	Plug (unit accessory)		
5	Pin 4	Video signal control DC control	Ground DRV -
	Pin 2	Video signal control DC control	Not used CONT +
7	Pin 1	Video signal control DC control	Power supply (DC 9 V/Max. 50 mA) CONT -
	Pin 3	Video signal control DC control	Video signal (0.7 Vp-p) DRV +

Fitting the lens **E**

- 1 Unscrew the lens mount cap.
- 2 Screw in the lens, and turn it until it is secured.
- 3 Insert the lens plug in the LENS connector.
When fitting a manual-iris lens, omit step 3.
- 4 According to the type of lens, adjust the focal length by turning the focal length adjustment ring.
- 5 Tighten the locking screw.

Caution

Keep the lens mount cap on the camera when not attaching a lens.

Installing the camera

When attaching the camera to a ceiling bracket or tripod, attach the supplied tripod adapter. The adapter may be attached to either the top or bottom of the camera. Use the supplied 1/4" UNC-20 screw to attach the camera to the tripod or ceiling bracket.

Cautions

- Use tripod screws and securely tighten them with a driver.
- Install the tripod adapter on a flat surface.

Connections **F**

- 1 Connect with VIDEO OUT connector.
 - 2 Connect with VIDEO IN connector on a video monitor, etc.
 - 3 SPT-M124: to AC 24 V, 60 Hz
SPT-M124CE: to AC 24 V, 50 Hz
SPT-M128CE: to AC 220 - 240 V, 50 Hz
SPT-M122CE: to DC 12 V
- ① 75-ohm coaxial cable
② Power cable

Phase Adjustment **G**

When using more than one camera, connect to a camera switcher and set the vertical phase range as follows:

- 1 Camera switcher
- 2 Monitor
- 3 Vertical phase
- 4 Adjustable range

Vertical phase **H**

The picture may roll vertically if the vertical phase is not set. To adjust the vertical phase, turn the V-PHASE adjustment screw at the back of

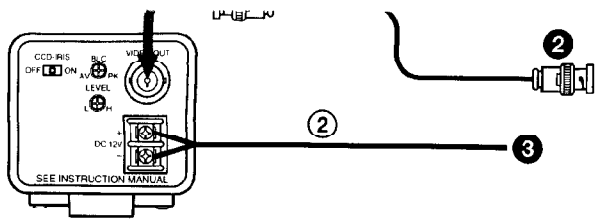

Once the incident light level has been preset at the factory, usually no further adjustment is required.

If the picture is too dark, however, or if the picture's highlights are extremely overexposed, adjust the LEVEL adjustment screw with a screwdriver. This adjustment can only be used for manual iris lens (when CCD IRIS ON/OFF switch is set to "ON") or DC controlled auto iris lens.

- 1 Turn toward L (low) to make the picture darker.
- 2 Turn toward H (high) to make the picture brighter.

Adjusting the Back Light Control

You can compensate for backlight conditions by turning the BLC (Back Light Control) adjustment screw. When using this unit under backlight conditions, turn the BLC adjustment screw towards AV. This adjustment can only be used for manual iris lens (when CCD-IRIS ON/OFF switch is set to "ON") or DC controlled auto iris lens.

CCD Characteristics

The following conditions may be observed when using a CCD camera are not due to any fault within the camera.

Vertical smear

This phenomenon occurs when viewing a very bright object.

Patterned noise

This is a fixed pattern which may appear over the entire monitor screen when the camera is operated at a high temperature.

Jagged picture

When viewing stripes, straight lines, or similar patterns, the image on the screen may appear jagged.

G

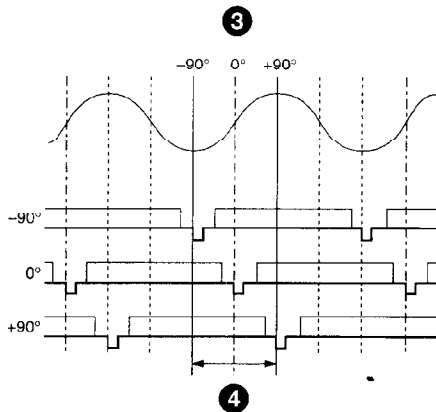
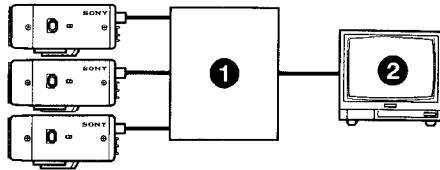

H



I

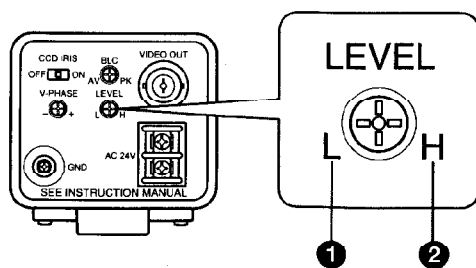

Specifications

Image device	1/3" interline transfer type CCD
Picture elements	SPT-124 : 510 (horizontal) × 492 (vertical) SPT-M122CE/M124CE/M128CE : 500 (horizontal) × 582 (vertical)
Signal system	SPT-M124 : EIA standards SPT-M122CE/M124CE/M128CE : CCIR standards
Sync system	SPT-M124/M124CE/M128CE : AC line lock SPT-M122CE : internal
Horizontal resolution	380 lines
Minimum illumination	0.1 lux (F1.2)
S/N	45 dB (AGC off)
Video output	1 Vp-p, 75 ohm, negative sync
CCD iris	SPT-M124 : 1/60 to 1/100000 sec SPT-M122CE/M124CE/M128CE : 1/50 to 1/100000 sec
Automatic Gain Control	Always ON
Power requirements	SPT-M124 : AC 24 V, 60 Hz SPT-M124CE : AC 24 V, 50 Hz SPT-M128CE : AC 220-240 V, 50 Hz SPT-M122CE : DC 12 V
Power consumption	SPT-M124/M124CE : 2.5 W SPT-M128CE : 3.5 W SPT-M122CE : 0.2 A (DC 12 V)
Operating temperature	-10°C to +50°C (14°F to 122°F)
Operating humidity	20 to 80%
Storage temperature	-40°C to +60°C (-40°F to 140°F)
Storage humidity	20 to 80%
Shock resistance	70G
Mass	SPT-M124/M122CE/M124CE : 320 g (11 oz) SPT-M128CE : 750 g (1 lb 10 oz) SPT-M124/M122CE/M124CE : 57 × 50 × 115 mm (2 1/4 × 2 × 4 5/8 inches) SPT-M128CE : 57 × 50 × 165 mm (2 1/4 × 2 × 6 1/2 inches)
Dimensions (w/h/d)	
Supplied accessories	Lens mount cap (1) Lens connector (1) Operating instructions (1)

Design and specifications are subject to change without notice.

SONY

Important Safeguards

For your protection, please read these safety instructions completely before operating the appliance, and keep this manual for future reference.

Carefully observe all warnings, precautions and instructions on the appliance, or the one described in the operating instructions and adhere to them.

Sony Corporation Printed in Japan © 1988

3-795-581-25 (1)

Use



Power Sources — This set should be operated only from the type of power source indicated on the marking label. If you are not sure of the type of electrical power supplied to your home, consult your dealer or local power company. For those sets designed to operate from battery power, or other sources, refer to the operating instructions.

Grounding or Polarization — This set is equipped with a polarized ac power cord plug (a plug having one blade wider than the other), or with a three-wire grounding type plug (a plug having a third pin for grounding). Follow the instructions below:

-For the set with a polarized ac power cord plug:

This plug will fit into the power outlet only one way. This is a safety feature. If you are unable to insert the plug fully into the outlet, try reversing the plug. If the plug should still fail to fit, contact your electrician to have a suitable outlet installed. Do not defeat the safety purpose of the polarized plug by forcing it in.



-For the set with a three-wire grounding type ac plug:

This plug will only fit into a grounding-type power outlet. This is a safety feature. If you are unable to insert the plug into the outlet, contact your electrician to have a suitable outlet installed. Do not defeat the safety purpose of the grounding plug.

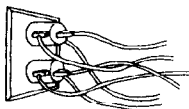
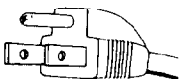

Overloading — Do not overload wall outlets, extension cords or convenience receptacles beyond their capacity, since this can result in fire or electric shock.

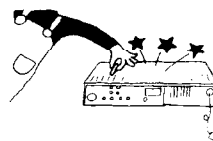

Object and Liquid Entry — Never push objects of any kind into the set through openings as they may touch dangerous voltage points or short out parts that could result in a fire or electric shock. Never spill liquid of any kind on the set.

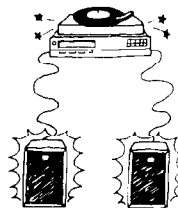

Attachments — Do not use attachments not recommended by the manufacturer, as they may cause hazards.

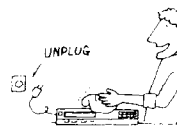

Cleaning — Unplug the set from the wall outlet before cleaning or polishing. Do not use liquid cleaners or aerosol cleaners. Use a cloth lightly dampened with water for cleaning the exterior of the set.



Power Sources — This set must only be connected to the type of power source indicated on the marking label. If you are not sure of the type of electrical power supplied to your home, consult your dealer or local power company. For those sets designed to operate from battery power, or other sources, refer to the operating instructions.

Grounding or Polarization — This set is equipped with a polarized ac power cord plug (a plug having one blade wider than the other) or with a three-wire grounding type plug (a plug having a third pin for grounding). Follow the instructions below:

-For the set with a polarized ac power cord plug:

This plug will fit into the power outlet only one way. This is a safety feature. If you are unable to insert the plug fully into the outlet, try reversing the plug. If the plug should still fail to fit, contact your electrician to have a suitable outlet installed. Do not defeat the safety purpose of the polarized plug by forcing it in.

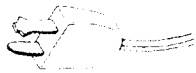

-For the set with a three-wire grounding type ac plug:

This plug will only fit into a grounding-type power outlet. This is a safety feature. If you are unable to insert the plug into the outlet, contact your electrician to have a suitable outlet installed. Do not defeat the safety purpose of the grounding plug.



Overloading — Do not overload wall outlets, extension cords or convenience receptacles beyond their capacity, since this can result in fire or electric shock.

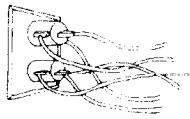

Installation

Water and Moisture — Do not use power-line operated sets near water — for example, near a bathtub, washbowl, kitchen sink, or laundry tub, in a wet basement, or near a swimming pool, etc.

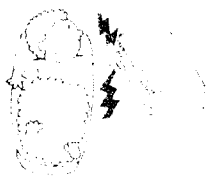

Power-Cord Protection — Route the power cord so that it is not likely to be walked on or pinched by items placed upon or against them, paying particular attention to the plugs, receptacles, and the point where the cord exits from the appliance.



Object and Liquid Entry — Never push objects of any kind into the set through openings as they may touch dangerous voltage points or short out parts that could result in a fire or electric shock. Never spill liquid of any kind on the set.

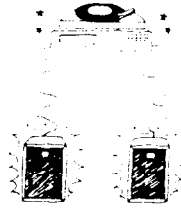

Attachments — Do not use attachments not recommended by the manufacturer as they may cause hazards.



Cleaning — Unplug the set from the wall outlet before cleaning or polishing it. Do not use liquid cleaners or aerosol cleaners. Use a cloth lightly dampened with water for cleaning the exterior of the set.

Accessories — Do not place the set on an unstable cart, stand, tripod, bracket, or table. The set may fall, causing serious injury to a child or an adult, and serious damage to the set. Use only a cart stand or table that is specifically recommended by the manufacturer.



An appliance and cart combination should be moved with care. Quick stops, excessive force, and uneven surfaces may cause the appliance and cart combination to overturn.

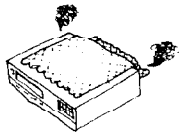

Ventilation — The slots and openings in the cabinet are provided for necessary ventilation. To ensure reliable operation of the set, and to protect it from overheating, these slots and openings must never be blocked or covered.
 -Never cover the slots and openings with a cloth or other materials.



-Never place the set in a confined space, such as a bookcase, or built-in cabinet, unless proper ventilation is provided.

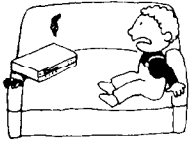

-Never block the slots and openings by placing the set on a bed, sofa, rug or other similar surface.

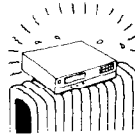

-Do not place the set near or over a radiator or heat register, or where it is exposed to direct sunlight.

Antennas

Outdoor Antenna Grounding — If an outdoor antenna or cable system is installed, follow the precautions below.

An outdoor antenna system should not be located in the vicinity of overhead power lines or other electric light or power circuits, or where it can come in contact with such power lines or circuits. **WHEN INSTALLING AN OUTDOOR ANTENNA SYSTEM, EXTREME CARE SHOULD BE TAKEN TO KEEP FROM CONTACTING SUCH POWER LINES OR CIRCUITS AS CONTACT WITH THEM IS ALMOST INVARIABLY FATAL.**

Be sure the antenna system is grounded so as to provide some protection against voltage surges and built-up static charges. Section 810 of the National Electrical Code provides information with respect to proper grounding of the mast and supporting structure, grounding of the lead-in wire to an antenna discharge unit, size of grounding conductors, location of antenna-discharge unit, connection to grounding electrodes, and requirements for the grounding electrode.

Antenna Grounding According to the National Electrical Code

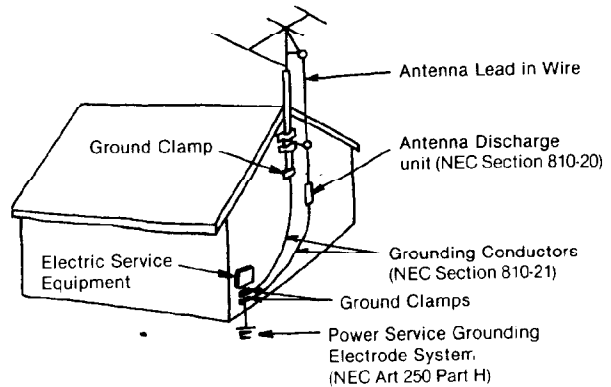

NEC-NATIONAL ELECTRICAL CODE

Lightning — For added protection for this set during a lightning storm, or when it is left unattended and unused for long periods of time, unplug it from the wall outlet and disconnect the antenna or cable system. This will prevent damage to the set due to lightning and power-line surges.

Service

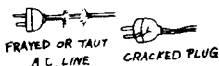

Damage Requiring Service — Unplug the set from the wall outlet and refer servicing to qualified service personnel under the following conditions:
 -When the power cord or plug is damaged or frayed.

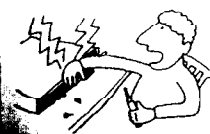

Servicing — Do not attempt to service the set yourself as opening or removing covers may expose you to dangerous voltage or other hazards. Refer all servicing to qualified service personnel.



-If liquid has been spilled or has fallen into the set.

Replacement parts — When replacement parts are required, be sure the service technician has used replacement parts specified by the manufacturer that have the same characteristics as the original parts. Unauthorized substitutions may result in fire, electric shock, or other hazards.

... TO KEEP FROM CONTACTING SUCH POWER LINES OR CIRCUITS AS CONTACT WITH THEM IS ALMOST INVARIABLY FATAL.

Be sure the antenna system is grounded so as to provide some protection against voltage surges and built-up static charges. Section 810 of the National Electrical Code provides information with respect to proper grounding of the mast and supporting structure, grounding of the lead-in wire to an antenna discharge unit, size of grounding conductors, location of antenna-discharge unit, connection to grounding electrodes, and requirements for the grounding electrode.

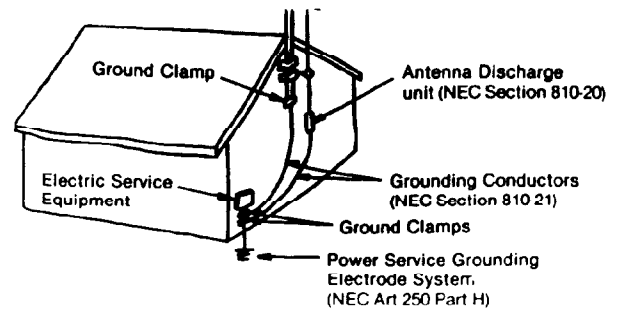

NEC-NATIONAL ELECTRICAL CODE

Lightning — For added protection for this set during a lightning storm, or when it is left unattended and unused for long periods of time, unplug it from the wall outlet and disconnect the antenna or cable system. This will prevent damage to the set due to lightning and power-line surges.

Service



Damage Requiring Service — Unplug the set from the wall outlet and refer servicing to qualified service personnel under the following conditions:

-When the power cord or plug is damaged or frayed.

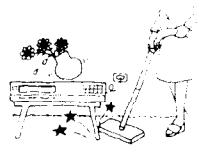

-If liquid has been spilled or objects have fallen into the set.



-If the set has been exposed to rain or water.

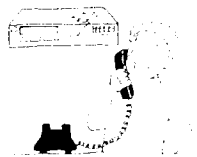

-If the set has been subject to excessive shock by being dropped, or the cabinet has been damaged.



-If the set does not operate normally when following the operating instructions. Adjust only those controls that are specified in the operating instructions. Improper adjustment of other controls may result in damage and will often require extensive work by a qualified technician to restore the set to normal operation.

-When the set exhibits a distinct change in performance — this indicates a need for service.



Servicing — Do not attempt to service the set yourself as opening or removing covers may expose you to dangerous voltage or other hazards.

Refer all servicing to qualified service personnel.

Replacement parts — When replacement parts are required, be sure the service technician has used replacement parts specified by the manufacturer that have the same characteristics as the original parts.

Unauthorized substitutions may result in fire, electric shock, or other hazards.

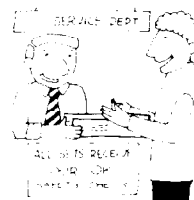

Safety Check — Upon completion of any service or repairs to the set, as the service technician to perform routine safety checks (as specified by the manufacturer) to determine that the set is in safe operating condition.