

SONY

3-858-410-12 (1)

Digital Still Camera

Operating Instructions

Before operating the unit, please read this manual thoroughly, and retain it for future reference.

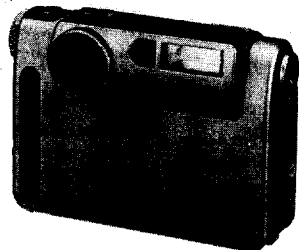

DSC-F1

©1996 by Sony Corporation

WARNING

To prevent fire or shock hazard, do not expose the unit to rain or moisture.

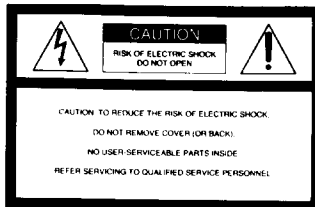

This symbol is intended to alert the user to the presence of uninsulated "dangerous voltage" within the product's enclosure that may be of sufficient magnitude to constitute a risk of electric shock to persons.



This symbol is intended to alert the user to the presence of important operating and maintenance (servicing) instructions in the literature accompanying the appliance.

Owner's Record

The model and serial numbers are located on the bottom. Record the serial number in the space provided below. Refer to these numbers whenever you call upon your Sony dealer regarding this product.

Model No. DSC-F1

Serial No. _____

For the Customers in the U.S.A. WARNING

This equipment has been tested and found to comply with the limits for a Class B digital device, pursuant to Part 15 of the FCC Rules. These limits are designed to provide reasonable protection against harmful interference in a residential installation. This equipment generates, uses, and can radiate radio frequency energy and, if not installed and used in accordance with the instructions, may cause harmful interference to radio communications. However, there is no guarantee that interference will not occur in a particular installation. If this equipment does cause harmful interference to radio or television reception, which can be determined by turning the equipment off and on, the user is encouraged to try to correct the interference by one or more of the following measures:

- Reorient or relocate the receiving antenna.
- Increase the separation between the equipment and receiver.
- Connect the equipment into an outlet on a circuit different from that to which the receiver is connected.
- Consult the dealer or an experienced radio/TV technician for help.

This device complies with Part 15 of the FCC Rules. Operation is subject to the following two conditions: (1) This device may not cause harmful interference, and (2) this device must accept any interference received, including interference that may cause undesired operation.

CAUTION

You are cautioned that any changes or modifications not expressly approved in this manual could void your authority to operate this equipment.

**For the customers
in the United States
and Canada**

**DISPOSAL OF LITHIUM ION
BATTERY AND VANADIUM-
LITHIUM BATTERY.**

**LITHIUM ION BATTERY AND
VANADIUM-LITHIUM BATTERY.
DISPOSE OF PROPERLY.**

You can return your unwanted lithium ion batteries and vanadium-lithium batteries to your nearest Sony Service Center or Factory Service Center.

Note: In some areas the disposal of lithium ion batteries and vanadium-lithium batteries in household or business trash may be prohibited.

For the Sony Service Center nearest you call 1-800-222-SONY (United States only).

For the SONY Factory Service Center nearest you call

416-499-SONY (Canada only).

Caution: Do not handle damaged or leaking lithium ion batteries and vanadium-lithium batteries.

**For the Customers in CANADA
CAUTION**

TO PREVENT ELECTRIC SHOCK, DO NOT USE THIS POLARIZED AC PLUG WITH AN EXTENSION CORD, RECEPTACLE OR OTHER OUTLET UNLESS THE BLADES CAN BE FULLY INSERTED TO PREVENT BLADE EXPOSURE.

**Be sure to read the
following before using
your camera.**

Trial recording

Before you record one-time events, you may want to make a trial recording to make sure that the camera is working correctly.

**No compensation for
contents of the recording**

Contents of the recording cannot be compensated for if recording or playback is not made due to a malfunction of the camera, video tape, etc.

Precaution on copyright

Television programs, films, video tapes, and other materials may be copyrighted. Unauthorized recording of such materials may be contrary to the provision of the copyright laws.

- IBM PC/AT is a registered trademark of International Business Machines Corporation of the U.S.A.
- MS-DOS and Windows are registered trademarks licensed to Microsoft Corporation, registered in the U.S.A. and other countries.
- Macintosh is a trademark licensed to Apple Computer, Inc., registered in the U.S.A. and other countries.
- All other product names mentioned herein may be the trademarks or registered trademarks of their respective companies.

Furthermore, "TM" and "@" are not mentioned in each case in this manual.

Table of contents

Basic Operations

Recording and playing back images	6
1 Install a battery.	6
2 Record images.	9
3 Play back images.	13
Printing the recorded images.....	16
Using personal computers.....	20

Selecting menus

22	22
How to select menus	22
Menu chart	24

Various ways of recording

26	26
Recording images continuously (CONTINUOUS)	26
Recording images prior to and after pressing the shutter button (TIME MACHINE)	27
Recording 9 images on a single page (MULTI SCREEN)	28
Selecting image quality (IMAGE QUALITY)	29
Adjusting exposure (EXPOSURE)	30
Selecting shutter speed (SHUTTER SPEED)	31
Adjusting brightness of the flash (FLASH ADJ)	32
Setting the date and time (DATE)	33

Various ways of playback

35	35
Playing back multiple images at a time (SEARCH)	35
Enlarging a part of the image (ZOOM)	36
Playing back images in a continuous loop (SLIDE SHOW)	37

Protecting images 39

Preventing accidental erasure (PROTECT)	39
Deleting images (DELETE)	40

Using image data with other equipment 42

Equipment you can connect to your camera	42
Watching images on a TV screen	43
Printing the recorded images	43
Using image data on a personal computer (SERIAL)	44
Using image data on the equipment compatible with infrared data communication system (TRANSFER)	46

Power sources 48

Power sources for this camera	48
Tips for using the rechargeable lithium ion battery	48

Additional information 50

Precautions	50
Troubleshooting	51
Warning and notice messages	53
Specifications	55
Parts identification	57
Glossary	59
Index	Back cover

 As you read through this manual, buttons and settings on the camera are shown in capital letters.
e.g., Press the MENU/EXECUTE jog dial.

The indicators during playback

Every time you press DISPLAY while playing back an image, the indications on the LCD screen change as follows: "Simplified indications" → "Detailed indications" → "No indication."

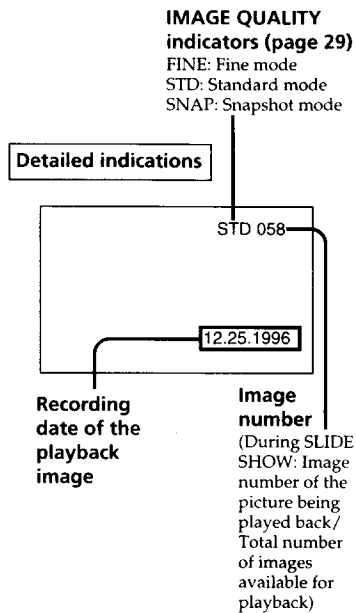
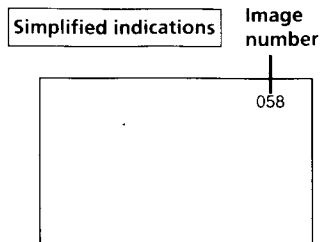

Adjusting the brightness of the LCD screen

Use the BRIGHT +/- dial on the bottom of the camera.

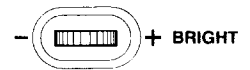

Deleting the recorded images

Select "DELETE" in the PLAY MENU. For details, see page 40.

Protecting images

To prevent accidental erasure, you can protect specific images. Select "PROTECT" in the PLAY MENU. For details, see page 39.

Note

If no image is recorded in memory, "NO IMAGE" appears on the LCD screen.

Rotating the screen

Each time you press ROTATE, you can rotate the image by 90°. This function enables you to change the direction of the image during playback.

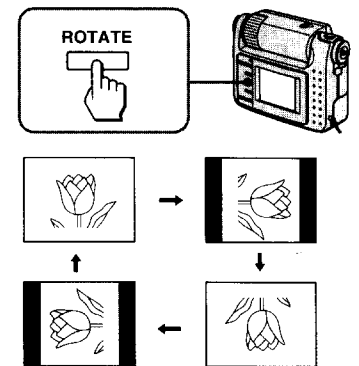

4 Start charging.

Set the POWER/Function dial on the camera to "CAMERA [A]" (automatic recording), then set it to "OFF." (While keeping the center button pressed, turn the POWER/Function dial.) By switching the setting of the POWER/Function dial from "CAMERA [A]" to "OFF," you can start charging.

It takes about 8 hours to fully charge the battery when the battery is empty. You can start using the camera when you charge the battery for 2 hours.

The CHARGE lamp, however, may not go off when the charge is completed due to operations during charging. If the CHARGE lamp does not go off after about 8 hours of charging, set the POWER/function dial to "CAMERA [A]" and check the remaining battery indicator. If you see the  mark on the LCD screen, this means the battery is fully charged. See page 10 to check the LCD indications.

Using AC power adapter

For long recording and playback indoors, use the camera on house current, using the AC power adapter.

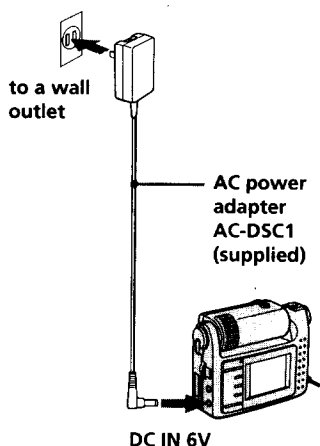

Auto power-off function

If you leave the camera in standby mode for about 2 minutes (during recording) or about 4 minutes (during playback) while the power is on, the camera turns off automatically. To resume power, set the POWER /Function dial to "OFF," and then set it to "CAMERA" or "PLAY," or press the shutter button gently. Auto power-off does not function when you use the AC power adapter.

To use the rechargeable battery prior to full charge

When you want to use the camera with the rechargeable lithium ion battery, you can use the battery before it is fully charged, disconnecting the AC power adapter from the DC IN 6V jack of the camera. Battery life, however, is shorter depending on charging time.

Battery life (approx. minutes)

Battery	Recording ^{a)}	Playback ^{b)}
Rechargeable lithium ion battery (LIP-10)	20	35

a) Battery life when continuing typical recording under the temperature of 77°F (25°C). If you repeat entering standby mode, turning power on and off, etc., the actual battery life may be shorter.

b) Battery life when playing back images on the LCD screen of the camera.

When to charge rechargeable battery

When you press DISPLAY during recording, the remaining battery indicator appears on the LCD screen.

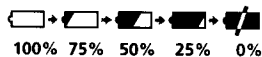

Continue to the next page → 7

■ Note on the remaining battery indicator

To check the remaining battery, turn on the power first and wait for about 20 seconds or more. Then press DISPLAY. If you press DISPLAY soon after the power-on, the battery condition is still unstable, and more than the actual remaining is displayed.

■ Notes

- When you use the camera on the rechargeable lithium ion battery, make sure to use the fully charged one, which prevents you from missing to record one-time events due to battery shortage.
- The charging time and battery life vary depending on temperature and circumstances of use.
- If you set the POWER/Function dial to "CAMERA" or "PLAY," charging is suspended. To resume charging, set the dial to "CAMERA [A]," then set it to "OFF."
- If you use the camera with the AC power adapter and the rechargeable lithium ion battery is already installed into the camera, the power is turned off when you disconnect the plug from the DC IN jack of the camera. To resume power, set the POWER /Function dial to "OFF," and then set it to "CAMERA" or "PLAY," or press the shutter button gently.
- If you remove the rechargeable lithium ion battery or disconnect the AC power adapter during recording or playback, image data may get damaged. Make sure to set the POWER/Function dial to "OFF" first, then remove the rechargeable lithium ion battery or disconnect the AC power adapter.

■ If "CHARGE BATTERY" is displayed

If "CHARGE BATTERY" is displayed while using the camera, and the power is turned off automatically, stop using the rechargeable battery in the camera. Use the AC power adapter instead or replace the battery with the fully charged one. You can turn on the power again with the discharged battery, but the battery soon becomes dead and the power is turned off abruptly before the camera shuts off normally. This may cause the data damage. Make sure to use the AC power adapter or replace the battery with the charged one.

■ Note on replacing the battery pack

When you replace the rechargeable lithium ion battery LIP-10 with a new one, do not press the shutter button, or turn on or off the power by changing the settings of the POWER/Function dial until the replacement is completed. Memory data for date & time settings may be erased.

If the settings are erased, ①replace the rechargeable lithium ion battery with a new one, ②charge the battery, then ③set the clock again. (page 33)

2 Record images.

The automatic adjustment function enables you to shoot images easily.

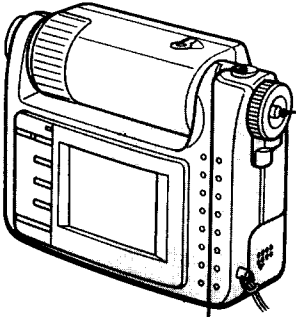

- ① While keeping the center button pressed, turn and set the POWER/Function dial to "CAMERA [A]" (automatic recording).

The image captured by the lens appears on the LCD screen.

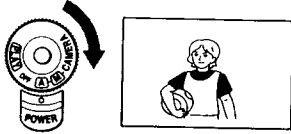

- ② Press the shutter button halfway down.

Continuous automatic adjustments of exposure are frozen and the AE (auto exposure) lock indicator (●) appears on the LCD screen.



- ③ Press the shutter button fully down.

The image displayed on the LCD is recorded and stored in memory.*

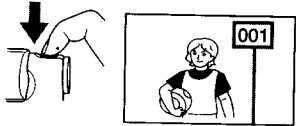

*After about 2 seconds, the still image changes to a new image captured by the lens. Then you can record another image.

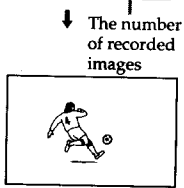

*Image quality is set to "STANDARD" and you can store up to 58 pictures.

The indicators during recording

Every time you press DISPLAY during recording, the indications on the LCD screen change as follows: "Simplified indications" → "Detailed indications" → "No indication." The indicators on the screen are not recorded.

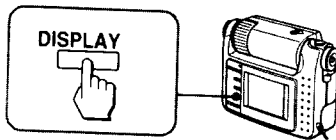

Simplified indications

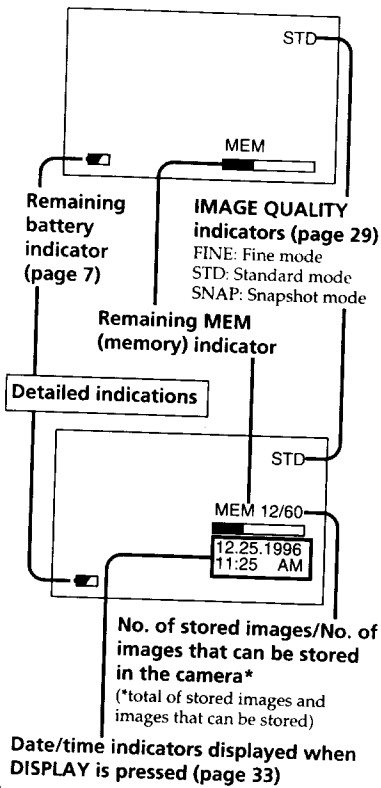

Automatic recording and manual recording

Recording mode is different depending on the setting of the function dial.

- ▣ "CAMERA [A]" (Automatic recording)
 The AE (Auto Exposure) function and AWB (Automatic White Balance) function adjust exposure, shutter speed, brightness of the flash, etc. automatically. Image quality is set to "STANDARD."
- ▣ "CAMERA [M]" (Manual recording)
 You can select exposure, shutter speed, recording mode, image quality, etc., manually in the CAMERA MENU.

Using the flash

Press FLASH. The CHARGE lamp flashes and the image disappears from the LCD screen. After about 12 seconds, the image appears again and the flash indicator (⚡) is displayed. Then you can shoot images using the flash.

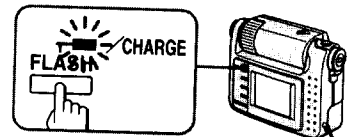

If you press FLASH while the flash indicator is displayed, flash mode is released, and the flash indicator disappears. If you do not press the shutter button within about 3 minutes after the flash indicator appears on the LCD screen, flash mode is also released.

If the exposure warning indicator (⊛) appears on the LCD screen, we recommend you to use the flash.

Recording images in macro

Turn the MACRO lever in the direction of the arrow. The macro indicator (M) appears on the LCD screen. You can shoot a subject that is about 3 inches (8 cm) to 9 inches (25 cm) away from the lens surface in macro mode. If you turn the MACRO lever in the opposite direction of the arrow until it clicks, macro mode is released and you can record images in normal mode.

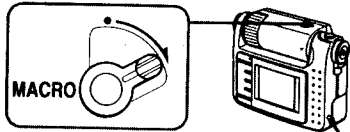

Adjust the focus on the LCD screen using the MACRO lever.

To adjust the focus precisely

Connect the VIDEO OUT jack of the camera to the video-in jack of the TV, and then check if the subject is in focus on the TV screen. (page 43)

Using the self-timer

With the self-timer about 10 seconds after you press the shutter button, the subject is recorded.

- 1 Press SELF TIMER.
The self-timer indicator (S) is displayed on the LCD screen.

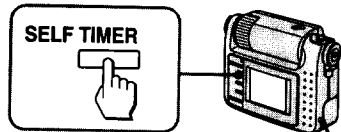

- 2 Press the shutter button halfway down.
The AE lock indicator (A) appears on the LCD screen.

- 3 Press the shutter button fully.
The shutter is released in about 10 seconds and the image is recorded.

During the 10-second countdown, the indicator disappears from the screen one by one.

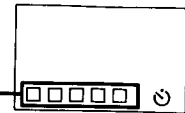

Changing the lens orientation — Face to face shooting

You can shoot yourself by placing yourself and the LCD screen face to face. Turn the LOCK lever in the direction of the arrow until the marks (•) are aligned so that you can release the lever, and rotate the lens at about 180°. You can lock the lens angle by turning the LOCK lever in the opposite direction of the arrow.

The images displayed on the LCD screen are mirror images. But they are stored in memory in the same way as you see through the lens.

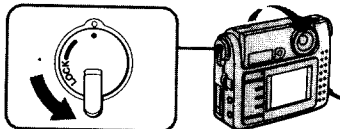

Recording the current image while displaying the image already recorded at a time (Review)

You can record an image captured by the lens while displaying the image already stored in memory. Press **I** (◀/■) while the image captured by the lens is displayed on the LCD screen.

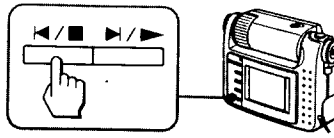

The image captured by the lens

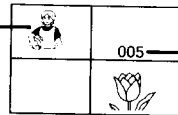
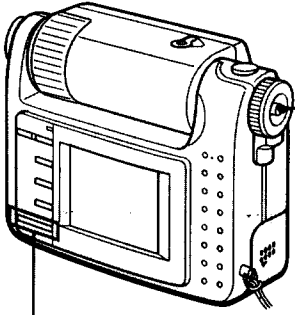

Image number

Press **I** (◀/■, ▶/▷) to change the image.

When you press EXIT, the LCD screen returns to the normal display, i.e., the image captured by the lens. If you do not press any button for 10 seconds or more, the screen also returns to the normal display.

3 Play back images.



① While keeping the center button pressed, turn and set the POWER/Function dial to "PLAY."
The last recorded image appears on the LCD screen.

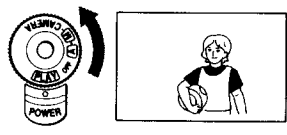

② Scroll the images, using the ◀/■, ▶/▷.

Each time you press ◀/■, the previously recorded image is displayed on the LCD screen.
Each time you press ▶/▷, the next image is displayed.

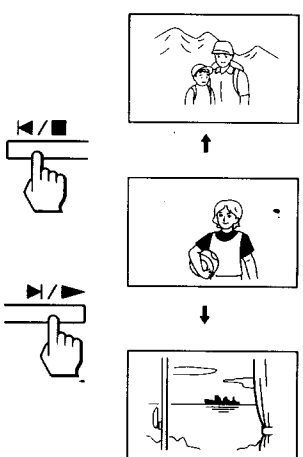

Continue to the next page →

The indicators during playback

Every time you press DISPLAY while playing back an image, the indications on the LCD screen change as follows: "Simplified indications" → "Detailed indications" → "No indication."

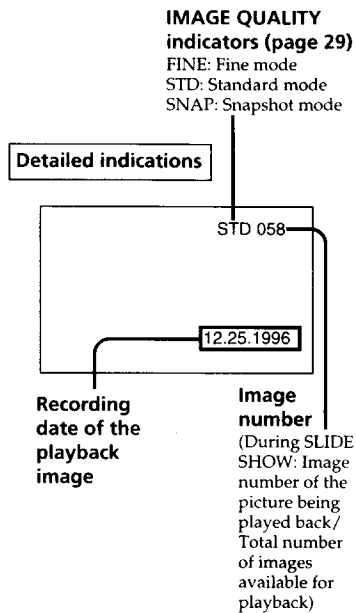
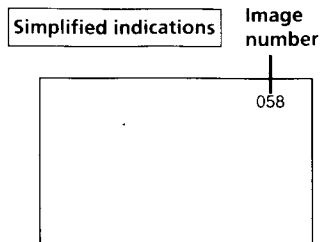

Adjusting the brightness of the LCD screen

Use the BRIGHT +/- dial on the bottom of the camera.

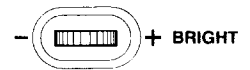

Deleting the recorded images

Select "DELETE" in the PLAY MENU. For details, see page 40.

Protecting images

To prevent accidental erasure, you can protect specific images. Select "PROTECT" in the PLAY MENU. For details, see page 39.

Note

If no image is recorded in memory, "NO IMAGE" appears on the LCD screen.

Rotating the screen

Each time you press ROTATE, you can rotate the image by 90°. This function enables you to change the direction of the image during playback.

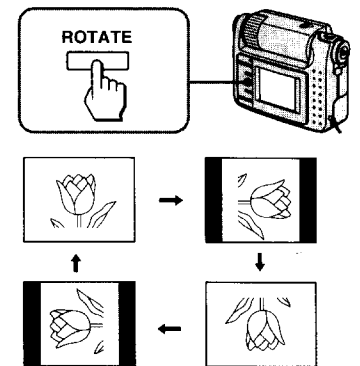

Hints for better shooting

For hand-held shots, do not move the camera. Stand steady on your feet.

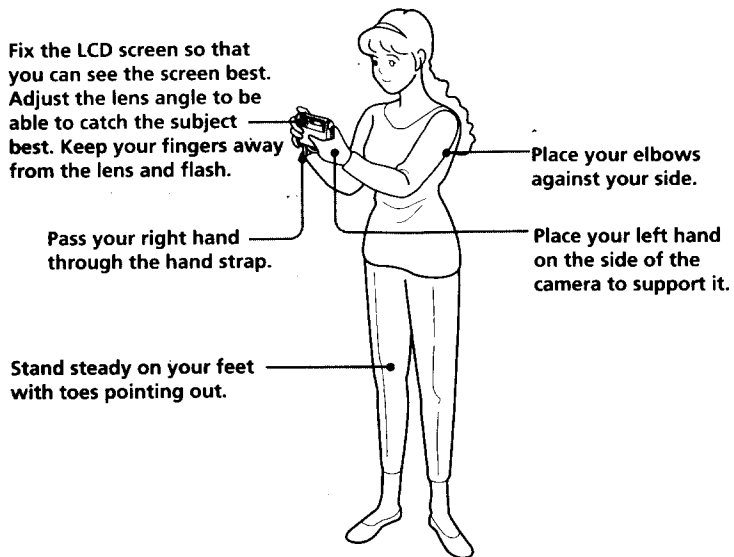

Recording in a low position

Adjust the lens angle upward.



Adjusting the lens angle

Turn the LOCK lever until the marks (•) are aligned so that you can release the lever, and adjust the lens angle. You can lock the lens angle at any position you want by turning the LOCK lever in the direction of the arrow.

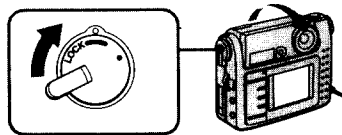

Printing the recorded images

You can print the images recorded by the camera using the Digital Color Printer DPP-M55 (not supplied). Use the PLAY MENU of the camera to operate the printer. For details, see the instruction manual of the printer.

- 1 Turn on the power of the printer. Place them so that the infrared port of each equipment faces the other.

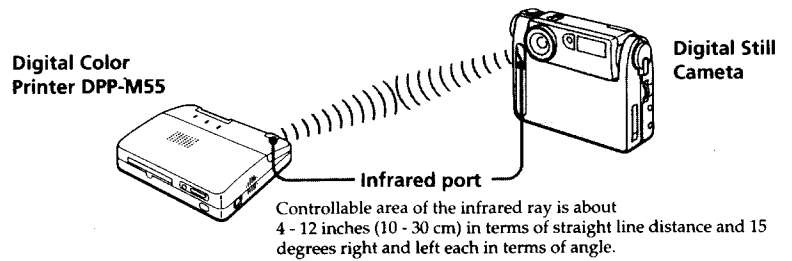

- 2 While keeping the center button pressed, turn and set the function dial to "PLAY."

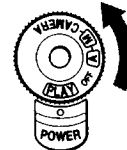

- 3 Press the MENU/EXECUTE jog dial.

The PLAY MENU appears on the LCD screen.

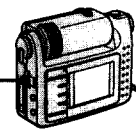
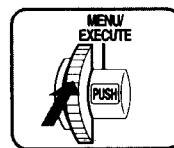

PLAY MENU
SEARCH
ZOOM
SLIDE SHOW
PROTECT
DELETE
↓TRANSFER

The selected item is highlighted (cursor).

- 4 Turn the MENU/EXECUTE jog dial to select "PRINT."

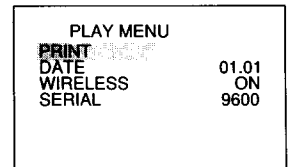
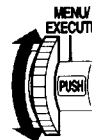

PLAY MENU
PRINT
DATE 01.01
WIRELESS ON
SERIAL 9600

5 Press the MENU/EXECUTE jog dial again.

The PRINT menu appears on the LCD screen.

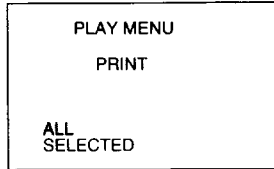

6 Select the images you want to print.

Printing all the images

Turn the MENU/EXECUTE jog dial to select "ALL" and press the MENU/EXECUTE jog dial.

Printing the selected images

- ① Turn the MENU/EXECUTE jog dial to select "SELECTED" and press the MENU/EXECUTE jog dial.
- ② Select the image, and specify it as the image to print.
Turn the MENU/EXECUTE jog dial to select the image you want to print, and press the MENU/EXECUTE jog dial to specify the image as the one to print. The image number of the specified image appears highlighted. (If you press the MENU/EXECUTE jog dial again, the image is no longer the image to print.)
- ③ Press EXIT.
The PRINT EXECUTE screen appears on the LCD screen.

Screen for selecting an image

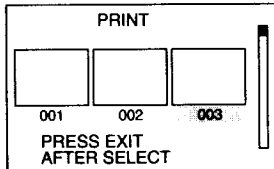

Screen for starting printing (PRINT EXECUTE screen)

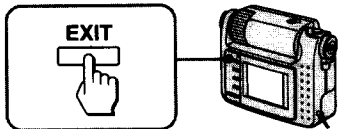
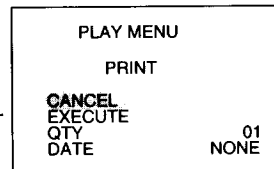

Continue to the next page →

7 Set the number of print copies, and select printing with your choice of date and time.

- ① To set the number of print copies, select "QTY" in the PRINT menu, and turn the jog dial to set the number. Press the MENU/EXECUTE jog dial. To select printing with date or with date & time, select "DATE" or "DATE & TIME" and press the MENU/EXECUTE jog dial.
- ② Turn the jog dial to set the number of print.

Turn the jog dial	No. of print copies	Date and time
Upward	Increases (up to 25 copies)	Settings scroll in the order of "NONE" → "DATE" → "DATE & TIME."
Downward	Decreases (minimum 1 copy)	Settings scroll in the order of "DATE & TIME" → "DATE" → "NONE."

- ③ When you have finished the settings, press the MENU/EXECUTE jog dial.

8 Select "EXECUTE" in the PRINT menu and press the MENU/EXECUTE jog dial.

9 Insert print paper into the paper outlet of the printer sheet by sheet.

Printing starts.
When printing is completed, the LCD screen returns to the PLAY MENU.

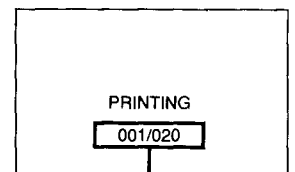

The current print number/
Total print number

To suspend printing

Press EXIT.

To stop operation during the above procedures, also press EXIT.



💡 To print a number of printouts at a time

When you want to print a number of printouts, we recommend you to use an automatic feeder specially designed for the printer. If you attach an automatic feeder to the printer, the print paper is loaded automatically, which saves you from inserting the paper sheet by sheet.

If the printer suspends printing, the print paper in the automatic feeder may have run short. For details, refer to the instruction manual of the printer and automatic feeder.

■ Notes

- Controllable area of the infrared ray is about 4 - 12 inches (10 - 30 cm) in terms of straight line distance and 15 degrees right and left each in terms of angle. Do not place the printer and camera outside the area or place them too close, which may interrupt transferring or results in noises.
- Do not cover the infrared port with your hand or any other objects.
- Infrared rays cannot pass through a wall, opaque glass, etc. If they pass through glass, etc., the controllable distance becomes short.

Using personal computers

To design, edit, and manipulate images from the camera using a personal computer, use the personal computer connecting kit DSKIT-PC1W (for Windows) or DSKIT-PC1M (for Macintosh) that is supplied with the camera. A personal computer connecting kit includes a connecting cable and application software that enables you to utilize image data transmitted from the camera. For details on configuration, refer to the instruction manual of the personal computer connecting kit that is also supplied with the camera.

- 1 If you have a personal computer compatible with an infrared data communication system (IBM PC/AT compatible PC)**

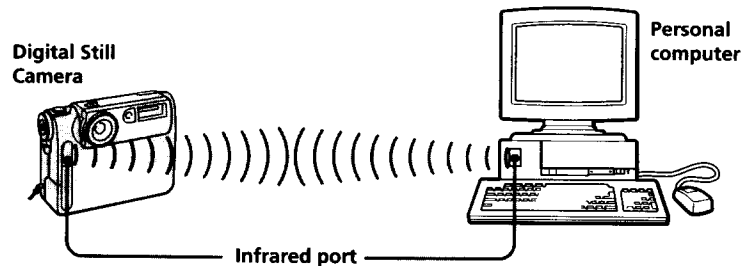

Place the infrared port located on the front panel of the digital still camera and that of the personal computer face to face so that you can transmit image data from the camera to the computer or vice versa.

- 2 If you have a personal computer that has a serial port (an RS-232C port for IBM PC/AT compatible PC or a modem/printer port for Macintosh)**

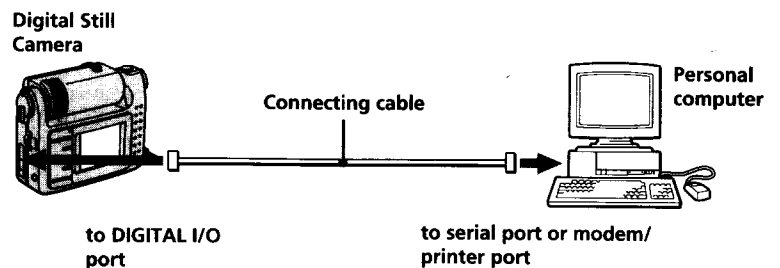

Connect your personal computer to the DIGITAL I/O port of the camera, using the connecting cable supplied with the personal computer connecting kit. For details, see "Using image data on a personal computer" (page 44).

Using personal computers

►Selecting menus

How to select menus

Most operations are made using the menu screens. Once you've learned how to use the menus, you can do most operations of the camera.

- 1 While keeping the center button of the function dial pressed, set the dial to "CAMERA **M**" or "PLAY."

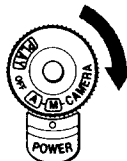

Position of the function dial	Menu
CAMERA M	CAMERA MENU
PLAY	PLAY MENU

- 2 Press the MENU/EXECUTE jog dial. The menu appears on the LCD screen.

Selected item is highlighted (cursor)

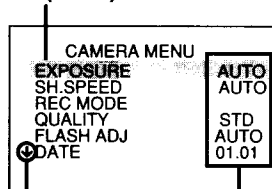

To the next page Current settings (mode)

- 3 Turn the MENU/EXECUTE jog dial so that the cursor moves to the item you want to select.

- 4 Press the MENU/EXECUTE jog dial. The item you want is selected, and the menu of that item appears on the LCD screen.

Function of the MENU/EXECUTE jog dial

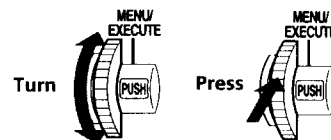

To select an item in the menu

Turn upward	To move the cursor upward
Turn downward	To move the cursor downward

To move on the LCD screen

Turn upward	To move left
Turn downward	To move right

To select an image

Turn upward	An image with the lower number appears
Turn downward	An image with the higher number appears

To input the number

Turn upward	To increase number
Turn downward	To decrease number

To enter selection

Press the MENU/EXECUTE jog dial. If you press the jog dial again after you select an item, selection is canceled.

To cancel menu operations

Press EXIT. The LCD screen shows the previous settings. If the CAMERA MENU or the PLAY MENU is displayed when you press EXIT, an image captured by the lens or the playback image appears on the screen.

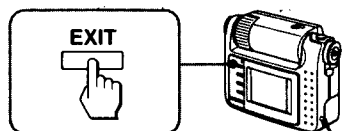

Menu chart

The Digital Still Camera has two menus: CAMERA MENU and PLAY MENU. These menus are displayed on the LCD screen. Refer to the pages indicated in () for details.

CAMERA MENU

This menu is used to set the shooting conditions and various recording modes. Set the function dial to "CAMERA **M**."

CAMERA MENU	
EXPOSURE	AUTO
SH. SPEED	AUTO
REC. MODE	
QUALITY	STD
FLASH ADJ	AUTO
DATE	01.01

↑ Turn the MENU/
EXECUTE jog dial to
turn the pages over.
↓

CAMERA MENU	
↑ WIRELESS	OFF
SERIAL	9600

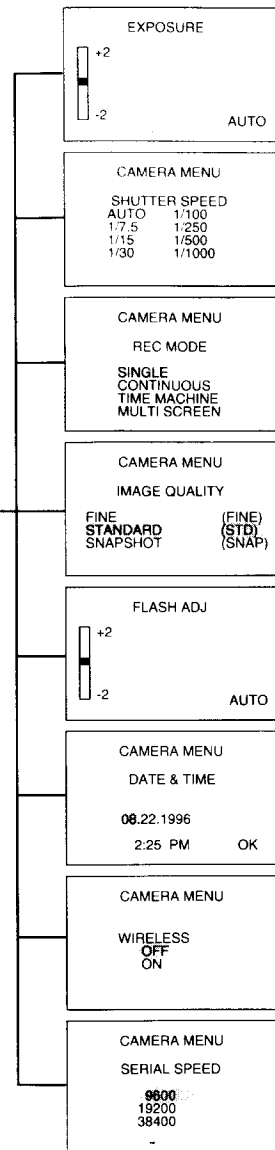

EXPOSURE menu
To adjust exposure when you shoot a subject with the light source behind. (30)

SHUTTER SPEED menu
To select the shutter speed. (31)

REC (recording) MODE menu
To select the mode to record images prior to and after pressing the shutter button, etc. (26)

IMAGE QUALITY menu
To change the picture quality at the time of recording. (29)

FLASH ADJ (adjustment) menu
To adjust brightness of the flash. (32)

DATE & TIME menu
To adjust date and time recorded with an image. (33)

WIRELESS menu
To enable or disable infrared data communication (44)

SERIAL SPEED menu
To set the communication speed through the RS-232C port. (45)

PLAY MENU

This menu is used to set various ways of playback, those in processing the recorded images and enabling/disabling infrared data communication. Set the function dial to "PLAY."

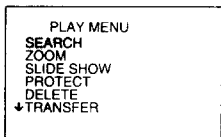

↑ Turn the MENU/ EXECUTE jog dial to turn the pages over.
↓

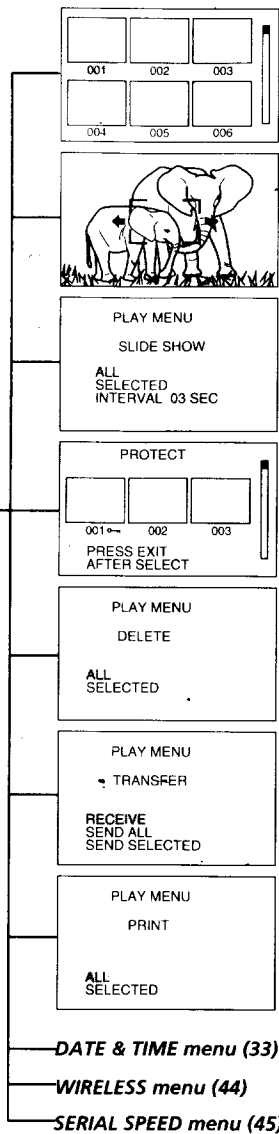
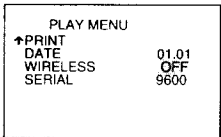

SEARCH menu

To display 6 recorded images on the LCD screen for image searching. (35)

ZOOM menu

To enlarge a part of the recorded image. (36)

SLIDE SHOW menu

To display all or selected images in order automatically. (37)

PROTECT menu

To protect specific images from accidental erasure. (39)

DELETE menu

To delete all or selected images. (40)

TRANSFER menu

To send and receive data to and from the other equipment that has an infrared data communication system compatible with that of this camera. (46)

PRINT menu

To print images on a digital color printer that has an infrared data communication system compatible with that of this camera. (43)

► Various ways of recording

Recording images continuously (CONTINUOUS)

When you press the shutter button, you can continuously record 4 images in STANDARD mode or 6 images in SNAPSHOT mode.

When to use? To capture high-speed action in sports.

Press the shutter button. ↓
Recording continuously at about 0.2 second intervals.

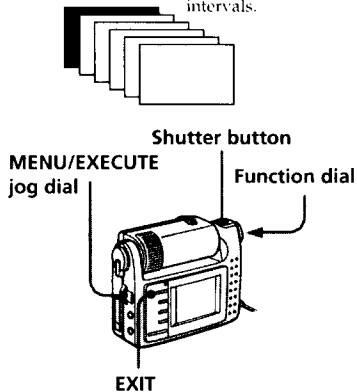

1 Set the function dial to "CAMERA [M]" and press the MENU/EXECUTE jog dial. The CAMERA MENU appears on the LCD screen.

CAMERA MENU	
EXPOSURE	AUTO
SH.SPEED	AUTO
REC MODE	
QUALITY	STD
FLASH ADJ	AUTO
↓DATE	01.01

2 Select "REC MODE" and press the MENU/EXECUTE jog dial. The REC MODE menu appears on the LCD screen.

CAMERA MENU	
REC MODE	
SINGLE	
CONTINUOUS	
TIME MACHINE	
MULTI SCREEN	

- ▣ SINGLE: When pressing the shutter button once, you can record a single image.
- ▣ CONTINUOUS ([]): When pressing the shutter button once, you can record 4 images (when image quality is set to "STN" (standard)) or 6 images ("SNAP" (snapshot)) continuously at about 0.25 second intervals.
- ▣ TIME MACHINE ([]): When pressing the shutter button once, you can record some of the previous and the next images continuously at about 0.5 second intervals.
- ▣ MULTI SCREEN ([]): When pressing the shutter button once, you can record 9 images continuously on a single page.

3 Select "CONTINUOUS" and press the MENU/EXECUTE jog dial. The screen returns to the CAMERA MENU.

CAMERA MENU	
EXPOSURE	AUTO
SH.SPEED	AUTO
REC MODE	[]
QUALITY	STD
FLASH ADJ	AUTO
↓DATE	01.01

REC MODE icon

4 Press EXIT.
The CAMERA MENU disappears from the LCD screen.

5 Press the shutter button.
As soon as you press the shutter button, you can record 4 images (in "STANDARD" mode) or 6 images (in "SNAPSHOT" mode) continuously at about 0.2 second intervals.

Image quality (STANDARD, SNAPSHOT, and FINE)

This camera has 3 image quality modes. For details, see "Selecting image quality" on page 29.

To cancel CONTINUOUS mode

Select "SINGLE" on the REC MODE menu. When you cancel TIME MACHINE mode and MULTI SCREEN mode, select "SINGLE."

Notes

- During CONTINUOUS recording, you cannot do the following operations:
 - Flash recording
 - Selecting "FINE" mode on the IMAGE QUALITY menu
 - Setting exposure automatically by pressing the shutter button halfway down
- If you try to select CONTINUOUS recording mode when there are not enough memory pages remaining, "NOT ENOUGH MEMORY" appears on the LCD screen and you cannot select this mode.

Recording images prior to and after pressing the shutter button (TIME MACHINE)

You can record images prior to and after pressing the shutter button by storing images continuously in a buffer memory.

When to use?

To select the best shot among several images.

Press the shutter button.



Recording the previous and following images at about 0.5 second intervals.

Various ways of recording

1 Select "TIME MACHINE" on the REC MODE menu.

2 Press the shutter button halfway down.

Images are stored in memory at 0.5 second intervals. The images on the LCD screen also changes at 0.5 second intervals (when you release the shutter button, storing of images stops.)

3 Press the shutter button fully down.

You can record images (4 images in total in STANDARD mode and 6 images in total in SNAPSHOT mode) prior to and after pressing the shutter button at 0.5 second intervals.

Continue to the next page →

Image quality	Previous	Next
SNAP (SNAPSHOT)	3 images	3 images
STD (STANDARD)	2 images	2 image

Notes

- During TIME MACHINE recording, you cannot do the following operations:
 - Flash recording
 - Self-timer recording
 - Selecting "FINE" mode on the IMAGE QUALITY menu
 - Fixing exposure automatically by pressing the shutter button halfway down
- If you try to select TIME MACHINE recording mode when there are not enough memory pages remaining, "NOT ENOUGH MEMORY" appears on the LCD screen and you cannot select this mode.

Recording 9 images on a single page (MULTI SCREEN)

As soon as you press the shutter button, you can record 9 images in succession on a single page.

When to use?

Want to see high-speed action on a single page

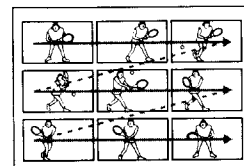

- 1 Select "MULTI SCREEN" on the REC MODE menu.
- 2 Press the shutter button halfway down, and then press it down fully.
As soon as you press the shutter button, you can record 9 images continuously (as in the flow shown in the above illustration) on a single page at 1/15 second intervals.

Note

During MULTI SCREEN recording, you cannot do the following operations:

- Flash recording
- Fixing the exposure automatically by pressing the shutter button halfway down

Selecting image quality (IMAGE QUALITY)

You can select one of three available image quality modes. The number of images you can record is different depending on which image quality mode you select.

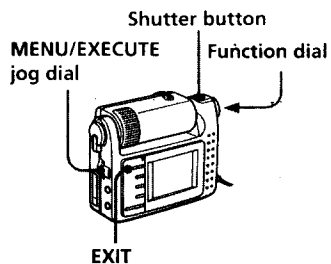

- 1 Set the function dial to "CAMERA [M]" and press the MENU/EXECUTE jog dial. The CAMERA MENU appears on the LCD screen.

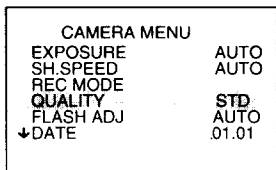

- 2 Select "QUALITY" and press MENU/EXECUTE jog dial. The IMAGE QUALITY menu appears on the LCD screen.

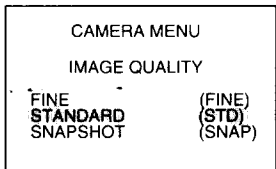

- FINE (FINE): Use this mode when giving priority to image quality. (30 images can be stored at maximum.)

- ▣ STANDARD (STD): Use this mode as a standard image quality. When "CAMERA [A]" (automatic recording) is selected, the image quality mode is set to "STD." (58 images can be recorded at maximum.)

- ▣ SNAPSHOT (SNAP): Use when giving priority to the number of shots to be recorded. (108 images can be stored at maximum.)
- 3 Select the image quality and press the MENU/EXECUTE jog dial. The screen returns to the CAMERA MENU.

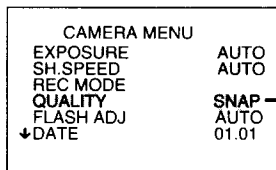

Selected mode

- 4 Press EXIT. The CAMERA MENU disappears from the screen.

Note
When you select CONTINUOUS or TIME MACHINE mode, you cannot select "FINE."

What is the difference in the image quality mode?

An image is compressed in the JPEG format before recording. The memory capacity allocated to each image is different depending on the image quality as follows (the number of pixels is 640 × 480 regardless of image quality mode and data volume before compression is about 450 kB):

FINE mode	120 kB
STANDARD mode	64 kB
SNAPSHOT mode	32 kB

Selecting shutter speed (SHUTTER SPEED)

The shutter speed is automatically adjusted during automatic recording. You can also manually fix the shutter speed.

When to use?

To compensate for a background light, a light source such as a fluorescent light, and action speed of the subject.

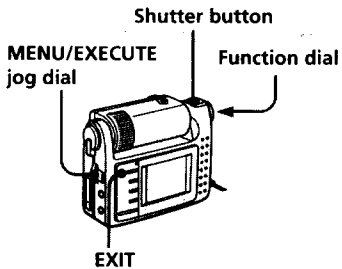

- 1 Set the function dial to "CAMERA M" and press the MENU/EXECUTE jog dial. The CAMERA MENU appears on the LCD screen.

CAMERA MENU	
EXPOSURE	AUTO
SH.SPEED	AUTO
REC MODE	
QUALITY	STD
FLASH ADJ	AUTO
↓DATE	01.01

- 2 Select "SH. SPEED" and press the MENU/EXECUTE jog dial. The SHUTTER SPEED menu appears on the LCD screen.

CAMERA MENU	
SHUTTER SPEED	
AUTO	1/100
1/7.5	1/250
1/15	1/500
1/30	1/1000

Auto	The best shutter speed is selected automatically according to the brightness of the subject
1/7.5 1/15	Shooting with a dark background such as twilight or night scenery
1/30	Shooting indoors
1/100	Shooting with flickering light such as a fluorescent light
1/250 1/500 1/1000	Shooting a subject with high-speed action

Various ways of recording

- 3 Select a shutter speed and press the MENU/EXECUTE jog dial. The screen returns to the CAMERA MENU.

CAMERA MENU	
EXPOSURE	AUTO
SH.SPEED	1/15
REC MODE	
QUALITY	STD
FLASH ADJ	AUTO
↓DATE	01.01

Shutter speed newly set

- 4 Press EXIT. The CAMERA MENU disappears from the screen.

Continue to the next page →

Notes

- When you fix the shutter speed, the image quality of certain subjects whose brightness does not meet that shutter speed may deteriorate.
- When you shoot a very bright subject at high speed, streaks may appear on the upper and lower sides of the LCD screen. This does not indicate a malfunction.
- When you set the shutter speed to 1/7.5 or 1/15, you cannot use a flash. To record a subject with a flash, you must select a shutter speed other than 1/7.5 and 1/15.

Adjusting brightness of the flash (FLASH ADJ)

You can adjust brightness of the flash.

When to use?

The brightness you want is not gained with a standard flash adjustment because of positioning of the subjects.

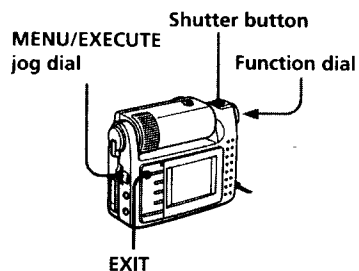

- 1 Set the function dial to "CAMERA **M**" and press the MENU/EXECUTE jog dial. The CAMERA MENU appears on the screen.

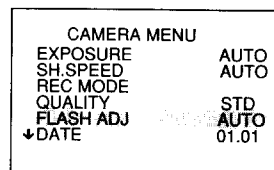

- 2 Select "FLASH ADJ" and press the MENU/EXECUTE jog dial. The FLASH ADJ menu appears on the LCD screen.

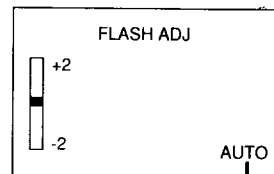

Current flash adjustment value

- 3** Turn the MENU/EXECUTE jog dial to adjust the brightness of flash, using the cursor pointer on the screen.

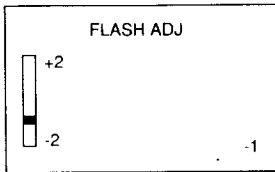

- 4** Press the MENU/EXECUTE jog dial. The screen returns to the CAMERA MENU.

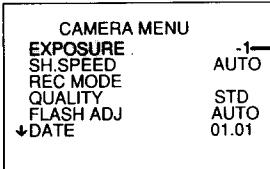

Newly selected value

- 5** Press EXIT. The CAMERA MENU disappears from the LCD screen.

Hints for setting the flash adjustment

When the subject or background is dark, the flash adjustment may become too high. In this case, adjust the flash level downwards. On the other hand, when the subject or background is bright, the flash adjustment may become too low. In this case, adjust the flash adjustment upwards. To set the flash adjustment properly, we recommend you to do a trial recording.

Note

When you set the shutter speed to 1/7.5 or 1/15, you cannot use a flash. To record a subject with a flash, you must select a shutter speed other than 1/7.5 and 1/15.

Setting the date and time (DATE)

Set the date and time before recording. You can record the date and time that can be displayed on the LCD screen with the image. At the time of printing, you can choose to print them with the image on the PRINT menu. Set the date and time according to the following procedure.

Various ways of recording

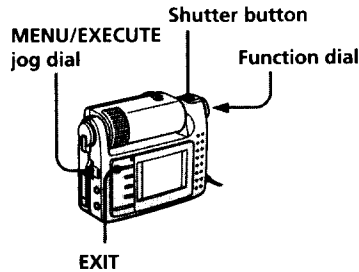

- 1** Set the function dial to "CAMERA " or "PLAY" and press the MENU/EXECUTE jog dial. The CAMERA MENU or PLAY MENU appears on the LCD screen.

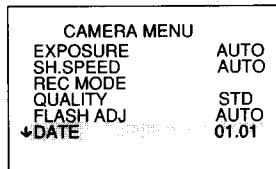

- 2** Select "DATE" and press the MENU/EXECUTE jog dial. The DATE & TIME menu appears on the LCD screen. "MONTH" is highlighted.

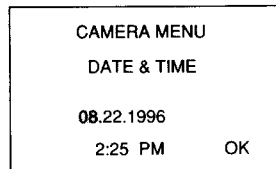

Continue to the next page → **33**

- 3** Set the "MONTH."
- ① Press the MENU/EXECUTE jog dial.
The color of the cursor on the month changes, which shows you can change the month.
 - ② Set the month, turning the MENU/EXECUTE jog dial.
 - ③ Press the MENU/EXECUTE jog dial.
The color of the cursor on the month returns to the initial one.

To set another item

Turn the MENU/EXECUTE jog dial to select another item.

- 4** Set the "DAY," "YEAR," "HOUR" and "MINUTE" in the same way as the month.

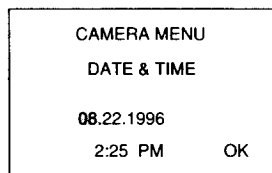

- 5** Select "OK" and press the MENU/EXECUTE jog dial at the announcement of the time on the radio, etc.

The screen returns to the CAMERA MENU or PLAY MENU and the clock starts.

- 6** Press EXIT.
The CAMERA MENU or PLAY MENU disappears from the LCD screen.

Memory back-up of the clock data

The camera uses the rechargeable lithium ion battery LIP-10 for storing clock data in memory. The clock in the camera works correctly for about 7 months with fully charged LIP-10. Though the clock continues to work for about 2 months even after the battery is used up, it is recommended that you always use the camera with the fully charged battery. When changing rechargeable lithium ion batteries, replace them within 10 minutes. The clock works correctly without the battery for 10 minutes. If the clock data is lost, set the date and time again after charging the battery.

► Various ways of playback

Playing back multiple images at a time (SEARCH)

You can play back 6 recorded images at a time. You can also select a specific image from the 6 images and enlarge it to full-size.

When to use?

To search for an image you want from all the recorded images.

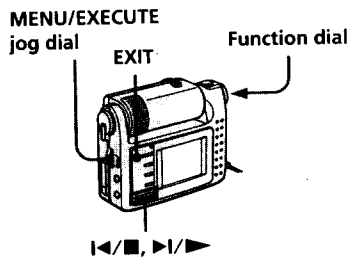

- 1 Set the function dial to "PLAY" and press the MENU/EXECUTE jog dial. The PLAY MENU appears on the LCD screen.

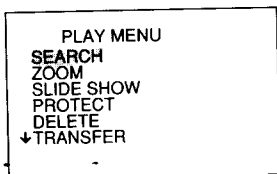

- 2 Select "SEARCH" and press the MENU/EXECUTE jog dial. 6 images are displayed at a time (SEARCH screen).

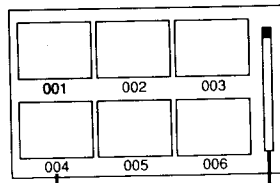

Image number Showing the position of an image whose number is highlighted

Enlarging a specific image you want to full size

- 1 Select an image by turning the MENU/EXECUTE jog dial.
- 2 Press the MENU/EXECUTE jog dial. Selected image is enlarged to full size.

Displaying the other images

Scroll the recorded images, using the **◀/■**, **▶/▶** buttons.

◀/■ Displaying images that have lower image numbers*

▶/▶ Displaying images that have higher image numbers*

* Scrolling images in the unit of 6 images on the SEARCH screen.

Returning to the SEARCH screen

Press EXIT.

Returning to the normal playback screen

Press EXIT twice. The PLAY MENU disappears from the LCD screen and the screen returns to the normal playback.

Enlarging a part of the image (ZOOM)

You can double the size of a part of the playback picture.

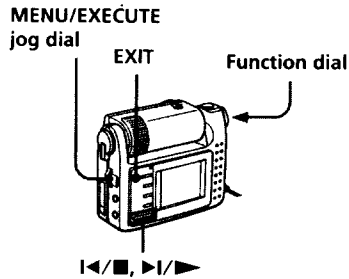
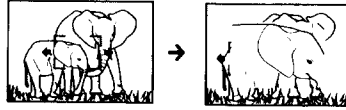

- 1 Set the function dial to "PLAY" and press the MENU/EXECUTE jog dial. The PLAY MENU appears on the LCD screen.

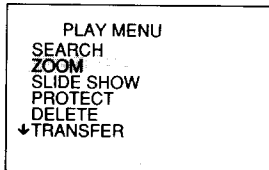

- 2 Select "ZOOM" and press the MENU/EXECUTE jog dial. A frame appears in the center of the screen. (A zooming frame screen)

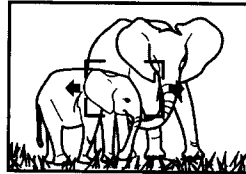

36

- 3 Move the frame to the position you want by turning the MENU/EXECUTE jog dial. You can move the frame right and left.

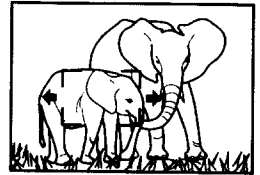

Moving the frame up and down

Press ROTATE and change the direction of the arrow to up and down. Then turn the MENU/EXECUTE jog dial. If you press ROTATE again, you can return the direction of the arrow to right and left.

- 4 Press the MENU/EXECUTE jog dial. The part you mark is doubled. The part to enlarge can be moved in the same way as explained in step 3.

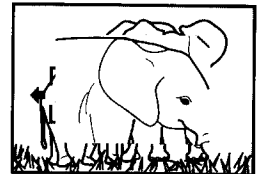

Enlarging a part of another image

Select another image, using **◀/■** or **▶/▷**. The center part of another image is enlarged.

◀/■ Displaying images that have lower image numbers

▶/▷ Displaying images that have higher image numbers

Canceling the ZOOM screen

Press EXIT.

Returning to the normal playback screen from a ZOOM screen

Press EXIT twice. The PLAY MENU disappears from the LCD screen and the screen returns to the normal playback.

Playing back images in a continuous loop (SLIDE SHOW)

Playing back all or selected images recorded in succession automatically.

When to use? For a presentation, etc.

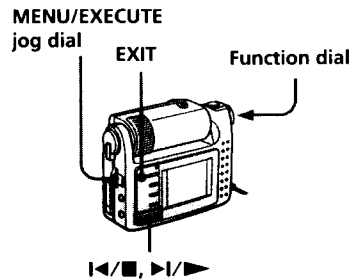

- 1 Set the function dial to "PLAY" and press the MENU/EXECUTE jog dial. The PLAY MENU appears on the LCD screen.
- 2 Select "SLIDE SHOW" and press the MENU/EXECUTE jog dial. The SLIDE SHOW menu appears on the LCD screen.

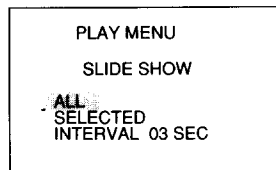

- ALL: Playing back all the images automatically
- SELECTED: Playing back programmed images automatically
- INTERVAL: Setting the interval of changing images between 1 to 20 seconds.

Continue to next page →

Various ways of playback

- 3** Set the intervals.
- ① Select "INTERVAL" and press the MENU/EXECUTE jog dial.
 - ② Set the intervals by turning the MENU/EXECUTE jog dial.
 - ③ Press MENU/EXECUTE jog dial.

- 4** Select the images to play back.

Playing back all the images

Select "ALL" and press the MENU/EXECUTE jog dial.

Playing back selected images

- ① Select "SELECTED" and press the MENU/EXECUTE jog dial.
- ② Select the image you want by turning the MENU/EXECUTE jog dial and enter the selection by pressing the jog dial. (If you press the jog dial again, entering is canceled.)

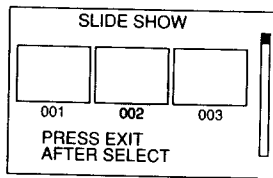

Repeat step ② to program the images.

- ③ Press EXIT.

- 5** Press ▶/▶ to start automatic playback.

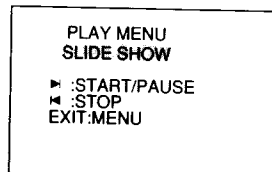

Playback starts automatically in numerical order from the image with the lower number. When the screen displays the last image, playback of the first image starts again and playback is continued until you stop it.

Pausing automatic playback

Press ◀/■. When you press ▶/▶ again, automatic playback starts again. When you press ◀/■, the screen returns to the one which was displayed before automatic playback starts.

Returning to the normal playback screen from a SLIDE SHOW menu

Press EXIT.

►Protecting images

Preventing accidental erasure (PROTECT)

To prevent accidental erasure, you can protect all or selected images.

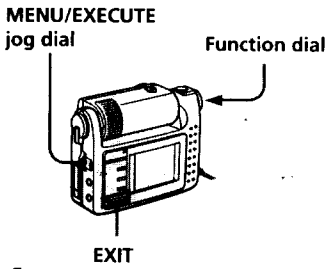

- 1 Set the function dial to "PLAY" and press the MENU/EXECUTE jog dial. The PLAY MENU appears on the LCD screen.

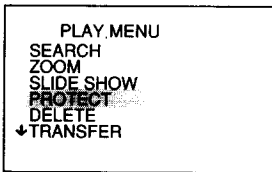

- 2 Select "PROTECT" and press the MENU/EXECUTE jog dial. The PROTECT menu appears on the LCD SCREEN.

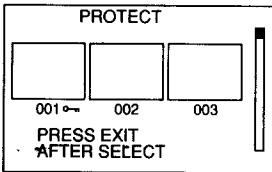

- 3 Select the images you want to protect. Select the image you want to protect by turning the MENU/EXECUTE jog dial and enter the selection by pressing the jog dial. The protect mark (◀) appears on the LCD screen. (If you press the jog dial again, entering is canceled.) If you want to protect more images, repeat this step.

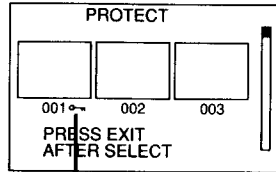

Protect mark

- 4 Press EXIT. The screen returns to the PLAY MENU.

Various ways of playback
Protecting images

Deleting images (DELETE)

You can delete all or selected images you do not want to keep any longer.

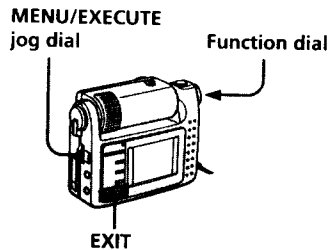

- 1 Set the function dial to "PLAY" and press the MENU/EXECUTE jog dial. The PLAY MENU appears on the LCD screen.

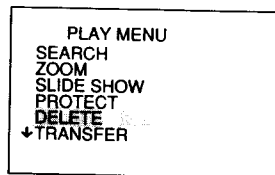

- 2 Select "DELETE" and press the MENU/EXECUTE jog dial. The DELETE menu appears on the LCD screen.

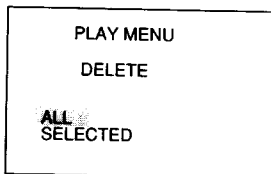

- ALL: To delete all the images.
- SELECTED: To delete selected images only.

- 3 Select the images you want to delete.

Deleting all the images
Select "ALL" and press the MENU/EXECUTE jog dial. The DELETE EXECUTE screen appears on the LCD screen.

Deleting selected images

- ① Select "SELECTED" and press the MENU/EXECUTE jog dial.
- ② Select the image you want to delete by turning the MENU/EXECUTE jog dial and enter it into memory by pressing the jog dial. The number of the selected image turns negative. If you press the jog dial again, entering is canceled. If you want to delete more images, repeat step ②.

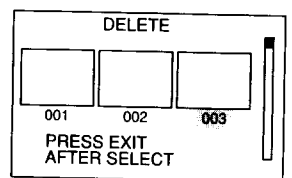

- ③ Press EXIT. The DELETE EXECUTE screen appears on the LCD screen.

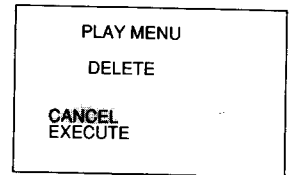

- 4 Select "EXECUTE" and press the MENU/EXECUTE jog dial. The selected images are deleted.

Notes

- When you select "SELECTED," you cannot select a protected image for deleting. When you select "ALL" and a protected image is included in the images you want to delete, "PROTECTED IMAGES REMAIN" appears on the LCD screen and you cannot delete it. In order to delete protected images, cancel their protection first.
- Once you delete an image, you cannot restore it. Check the images to delete carefully before deleting them.

Protecting images

►Using image data with other equipment

Equipment you can connect to your camera

You can send or receive image data to or from other equipment, using the VIDEO OUT jack, infrared port and DIGITAL I/O port on the camera.

Using infrared data communication (equipment in the  area of the chart)

Digital still camera
You can copy the recorded images. (46)



Other infrared data communication equipment
You can process the image data, etc. (46)



Connecting to the DIGITAL I/O port

Personal computer
You can design, edit, and manipulate images. (44)



Connecting to the VIDEO OUTPUT jack

TV
Use to monitor the recorded images and "SLIDE SHOW." (37)



Color video printer
You can print the recorded images. (43)



Digital color printer
You can print the recorded images. (16)



■Notes

- Before making connections, turn off each equipment. After connections are completed, turn on each equipment.
- When you use the camera for a long time, connecting to other equipment, use the AC power adapter.

Refer to the pages in () for details.

Watching images on a TV screen

Connect the camera to the TV that has a video jack. You can enjoy a "SLIDE SHOW" on the TV screen. When shooting an image in macro, you can adjust the focus more easily on the TV screen.

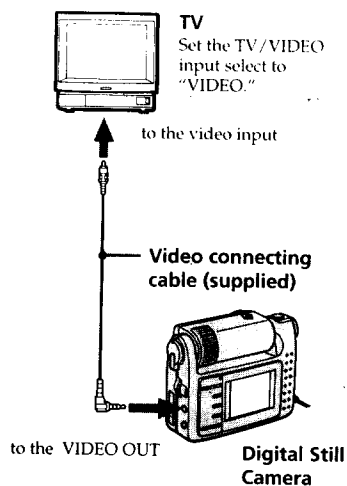

- 1** Connect the VIDEO OUT jack of the camera to the video input jack of the TV.
- 2** Set the TV/VIDEO input select on the TV to "VIDEO."
- 3** Start playback on the camera. Playback picture appears on the TV screen.

Notes

- You cannot use a TV that has an antenna (aerial) connector only.
- When the function dial is set to "CAMERA" and the lens is rotated to the same side as the LCD screen (face to face shooting), the image appears upside-down on the TV screen.

Printing the recorded images

You can transmit image data from this camera to a printer compatible with an infrared data communication system or through a video input jack. The printer prints image data.

The followings are the procedures to print the recorded images, using a color video printer. The procedures to print them on a printer compatible with the infrared data communication system are shown in "Printing the recorded images" on page 16.

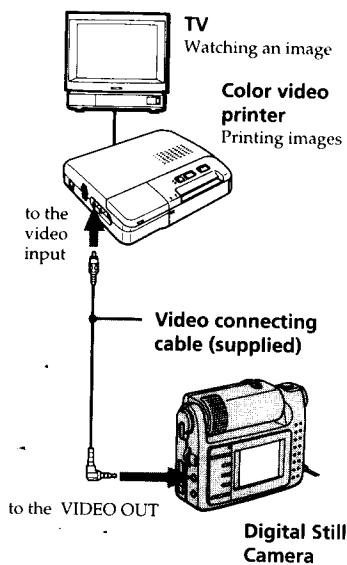

- 1** Connect the VIDEO OUT jack of the camera to the video input jack of the printer.
- 2** Start playback on the camera. Playback picture appears on the TV screen.

Using image data with other equipment

Continue to the next page →

- 3** The printer receives image data from the camera and starts printing.

For the detailed procedures, refer to the instruction manual of the printer.

Using image data on a personal computer (SERIAL)

You can send image data from the camera to a personal computer that has a serial port of IBM PC / AT compatible PC or a modem or printer port of Macintosh, using the supplied personal computer connecting kit.

For the detailed procedures to use image data on a personal computer that is compatible with infrared data communication system, refer to the instruction manual of the personal computer connecting kit.

Personal computer connecting kit

The following are supplied with the kit:

- a connecting cable that is for exclusive use for connecting a personal computer to the camera, and,
- application software to receive image data from the camera to a personal computer and utilize them on a personal computer.

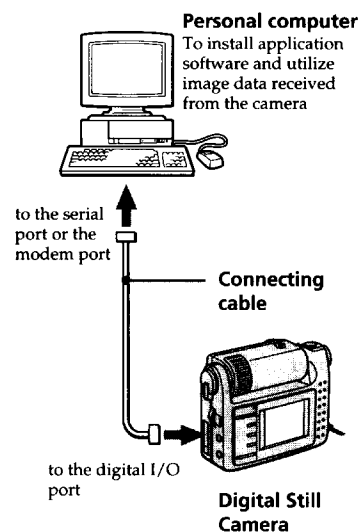

1 Connect the DIGITAL I/O port of the camera to the serial port of IBM PC/AT compatible PC or to the modem or printer port of Macintosh, using the supplied connecting cable.

2 Install the supplied application software into the personal computer.

3 Change menu settings to enable the camera to transmit or receive signals through the DIGITAL I/O port.

① Set the function dial to "CAMERA [M]" or "PLAY" and press the MENU/EXECUTE jog dial.

The first page of the CAMERA MENU or PLAY MENU appears on the LCD screen.

② Turn the MENU/EXECUTE jog dial to make the second page of the CAMERA MENU or PLAY MENU appear on the LCD screen.

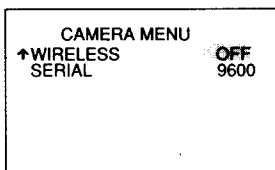

③ Select "WIRELESS ON" and press the MENU/EXECUTE jog dial. The WIRELESS menu appears on the LCD screen.

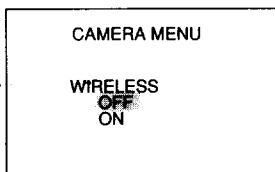

- OFF: To select the communications through the DIGITAL I/O port.
- ON: To select the communications using the infrared port.

④ Select "OFF" and press the MENU/EXECUTE jog dial. The screen returns to the second page of the CAMERA MENU or PLAY MENU.

4 Select the communication speed through the serial port or modem or printer port.

① Select "SERIAL SPEED" and press the MENU/EXECUTE jog dial. The SERIAL SPEED menu appears on the LCD screen.

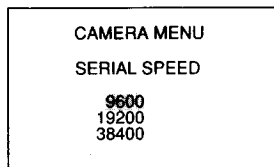

② Select the communication speed (bps) to match the personal computer and press the MENU/EXECUTE jog dial. The screen returns to the CAMERA MENU or the PLAY MENU.

5 Operate the personal computer to receive image data from the camera and utilize them.

For operation of the personal computer, refer to the instruction manual of the personal computer connecting kit.

Note

While you are operating the personal computer, you cannot operate the camera.

Using image data on the equipment compatible with infrared data communication system (TRANSFER)

You can transmit image data to or receive from another digital still camera, using infrared data communication system.

Equipment compatible with infrared data communication system such as another digital still camera

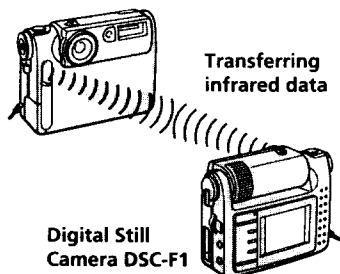

- Place the infrared port of this camera and that of the other equipment to be used for transferring face to face. (Controllable area is about 4 - 12 inches (10 - 30 cm) in terms of straight line distance and 15 degrees right and left each in terms of angle.)

Notes

- Place the infrared ports within the controllable area. Do not place them outside the area nor place them too close, which may interrupt transferring or cause noises.
- Do not cover the infrared port with your hand or any other objects.
- Infrared rays cannot pass through a wall, opaque glass, etc. If they pass through glass, etc., the controllable distance becomes short.

- Select "TRANSFER" and press the MENU/EXECUTE jog dial. The TRANSFER menu appears on the LCD screen.

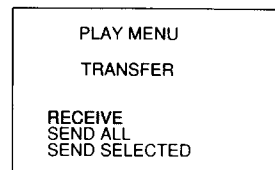

- RECEIVE: To receive image data from the other equipment.
- SEND ALL: To send all the image data to the other equipment.
- SEND SELECTED: To send selected image data only to the other equipment.

- Select the images to send.

To receive

Select "RECEIVE" and press the MENU/EXECUTE jog dial.

To send all the image data

Select "SEND ALL" and press the MENU/EXECUTE jog dial.

To send selected image data only

- Select "SEND SELECTED" and press the MENU/EXECUTE jog dial.
- Select the image data to send by turning the MENU/EXECUTE jog dial and enter them into memory by pressing the jog dial. (If you press the jog dial again, entering is canceled.)

If you want to select more images, repeat step ②.

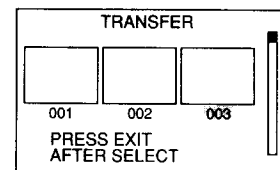

- ③ Press EXIT.
The TRANSFER EXECUTE menu appears on the LCD screen.

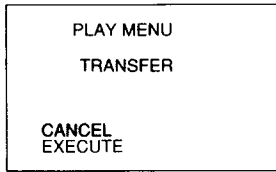

- 4 Prepare the equipment to receive or to transmit image data.

To receive data on your camera

Set the camera into data receiving standby mode, then start transmitting from the other equipment.

To transmit data from your camera

Set the other equipment into data receiving standby mode, then start transmitting from the camera.

- 5 Select "EXECUTE" and press the MENU/EXECUTE jog dial.
Data transfer starts.

"RCV" or "SEND" appears.

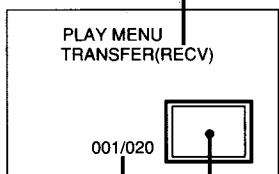

The number of images transferred/The total number of images to transfer

Image data being transferred

► Power sources

Power sources for this camera

You can operate the camera on the following two power sources:

- ❑ Rechargeable lithium ion battery LIP-10 (page 6)
- ❑ House current, using the AC power adapter AC-DSC1 (page 7)

■ On the AC power adapter

Use only the supplied adapter AC-DSC1. Do not use any other AC power adapter.

Polarity of the plug



■ Note

Do not pull on the cord of the AC power adapter. If you pull it forcibly, the plug may disconnect from the wall outlet. If you extend the cord fully to reach a wall outlet, the plug may easily become disconnected.

Tips for using the rechargeable lithium ion battery

On charging

Recharge the battery whenever you like

You do not have to discharge it before recharging.

Recharge the battery before use.

The battery is always discharging even when it is not in use after charging. Therefore, you should charge the battery right before using the camera.

On recording with batteries

Have sufficient battery power to do 2 to 3 times as much recording as you have planned.

On battery life

Battery life is shorter in a cold environment

Battery efficiency is decreased, and the battery is used up more quickly, if you are recording in a cold environment (lower than 50° F (10° C)). To make the battery life longer, it is recommended to try the following:

- Keep the battery warm in a pocket, etc., and install it right before using the camera. When using a body warmer, be careful the warmer does not touch the battery.
- Charge the battery as follows: Install the battery into the camera and connect the AC power adapter to the camera and a wall outlet. You should charge the battery at temperatures from 50 °F to 86°F (from 10 °C to 30° C). Lower temperatures require a longer charging time.

If the battery is new or has not been used for a long time, it may not be charged completely until you charge and discharge it several time.

Battery care

Keep the battery in a cool place.

Remove the battery from the camera if you do not use the camera for a long time, and keep it in a cool place.

On the terminals

Always keep the terminals clean.

If any solid objects or liquid fall onto the terminals, remove or wipe it completely with a cotton swab, etc. Then repeatedly install and remove the battery a few times. This improves the contact condition.

When to dispose of the battery pack?

You can discharge and charge the battery about 300 times repeatedly at normal temperatures. If the battery life is reduced by about half, replace it with a new battery pack.

► **Additional information**

Precautions

On moisture condensation

If the camera is brought directly from a cold to a warm location, or is placed in a very damp room, moisture may condense inside or outside the camera. Should this occur, the camera will not operate properly. In this case, remove the rechargeable lithium ion battery and open the lid of the battery compartment and wait about an hour for the moisture to evaporate.

How to prevent moisture condensation

When bringing the camera from a cold place to a warm place, put the camera in a plastic bag and allow it to adapt to room conditions over a period of time.

- ① Be sure to tightly seal the plastic bag containing the camera.
- ② Remove the bag when the air temperature inside it has reached the temperature surrounding it (about 1 hour).

On cleaning

Cleaning the LCD screen

Wipe the screen surface with the cleaning cloth (supplied) or a LCD cleaning kit (not supplied) to remove fingerprints, dust, etc.

Cleaning the camera surface

Clean the camera surface with a soft cloth slightly moistened with water. Do not use any type of solvent such as alcohol or benzene as it may mar the finish of the casing.

If you have any questions or problems concerning your camera, please consult your nearest Sony dealer.

Using your camera abroad

Power sources

You can use your camera in any country with the supplied AC power adapter within 100 V to 240 V AC, 50/60 Hz. If the plug of the AC power adapter does not match the wall outlet, use an AC plug adapter.

Watching the playback picture on TV

If you want to view the playback picture on a TV, you need a TV having a video input jack and a video connecting cable.

The color system of the TV must be the same as that of your digital still camera. TV color systems differ from country to country. Check the following list:

NTSC system countries

Bahama Islands, Bolivia, Canada, Central America, Chile, Colombia, Ecuador, Jamaica, Japan, Korea, Mexico, Peru, Surinam, Taiwan, the Philippines, the U.S.A., Venezuela, etc.

PAL system countries

Australia, Austria, Belgium, China, Denmark, Finland, Germany, Great Britain, Holland, Hong Kong, Italy, Kuwait, Malaysia, New Zealand, Norway, Portugal, Singapore, Spain, Sweden, Switzerland, Thailand, etc.

PAL-M system country

Brazil

PAL-N system countries



Argentina, Paraguay, Uruguay

SECAM system countries

Bulgaria, Czech Republic, France, Guiana, Hungary, Iran, Iraq, Monaco, Poland, Russia, Slovak Republic, Ukraine, etc.

Troubleshooting

Should any problem persist after you have made these checks, consult your nearest Sony dealer. If warning and notice messages appear on the LCD screen, see page 53.

Symptom	Cause/Solution
The camera does not work.	<ul style="list-style-type: none">• The rechargeable battery is dead (the  indicator appears on the LCD screen).<ul style="list-style-type: none">➔ Charge the rechargeable lithium ion battery.• The AC power adapter is not connected securely.<ul style="list-style-type: none">➔ Connect it to the DC IN 6V jack of the camera and a wall outlet firmly. (page 6)• The built-in micro computer does not work properly.<ul style="list-style-type: none">➔ Disconnect any power sources and reconnect it after one minute. Then turn the power on by setting the POWER/Function dial to "CAMERA" or "PLAY." If the camera still does not function properly, press RESET at the bottom, using a sharp-pointed object. (If you press RESET, all the settings in memory return to the default.)
You cannot record images.	<ul style="list-style-type: none">• The POWER/Function dial is not set to "CAMERA."<ul style="list-style-type: none">➔ Set the function dial to "CAMERA [A]" or "CAMERA [M]."• Memories are full.<ul style="list-style-type: none">➔ Delete certain images you do not want to keep, and then start recording. (page 40)• The rechargeable battery is dead (the  indicator appears on the LCD screen).<ul style="list-style-type: none">➔ Charge the rechargeable lithium ion battery.
The picture is out of focus.	<ul style="list-style-type: none">• The MACRO lever is set to the macro recording position.<ul style="list-style-type: none">➔ Turn the lever to the normal recording position. (page 11)
The picture is noisy.	<ul style="list-style-type: none">• The camera is placed near a TV or other equipment that uses strong magnets.<ul style="list-style-type: none">➔ Place the camera away from the TV, etc.
The picture is too dark.	<ul style="list-style-type: none">• You are shooting a subject with the light source behind the subject or light is insufficient.<ul style="list-style-type: none">➔ Adjust exposure. (page 30)➔ Adjust brightness of the LCD screen. (page 14)

Continue to the next page →

Symptom	Cause/Solution
The date is not recorded or printed.	<ul style="list-style-type: none"> • The rechargeable lithium ion battery is fully discharged. <ul style="list-style-type: none"> ➔ Charge the rechargeable battery and set the date and time again. (page 6, 33) • "NO DATE" is set on the PRINT menu. <ul style="list-style-type: none"> ➔ Change the setting on the PRINT menu to "DATE" or "DATE & TIME." (page 18)
Vertical streaks appear when shooting a very bright subject.	<ul style="list-style-type: none"> • The smear phenomenon. <ul style="list-style-type: none"> ➔ The camera is not malfunctioning.
The battery life deteriorates too fast.	<ul style="list-style-type: none"> • Charging of the rechargeable battery is not enough. <ul style="list-style-type: none"> ➔ Charge the battery fully. (page 6) • The rechargeable battery has served its time. <ul style="list-style-type: none"> ➔ Replace the battery with a new one. (page 6)
You cannot play back the images.	<ul style="list-style-type: none"> • The function dial is not set to "PLAY." <ul style="list-style-type: none"> ➔ Set the function dial to "PLAY." • The rechargeable battery is dead. <ul style="list-style-type: none"> ➔ Charge the rechargeable battery. (page 6)
When you set the POWER/Function dial to "CAMERA" or "PLAY," the camera does not turn on or work correctly.	<ul style="list-style-type: none"> • Malfunction occurred since you switched the POWER/Function dial repeatedly. <ul style="list-style-type: none"> ➔ Set the POWER/Function dial to "OFF," and then set it to "CAMERA" or "PLAY," or press the shutter button gently.
You cannot delete an image.	<ul style="list-style-type: none"> • The image is protected. <ul style="list-style-type: none"> ➔ Cancel the protection of the image on the PROTECT menu. (page 39)
You cannot send or receive the image data using infrared data communication system.	<ul style="list-style-type: none"> • The infrared ports of the equipment are not placed face to face. <ul style="list-style-type: none"> ➔ Place them face to face. (page 16, 46) • The equipment to receive the data is placed out of the remote controllable area or there is an obstacle between the infrared ports of the equipment and the camera. <ul style="list-style-type: none"> ➔ Place the equipment within 4 - 12 inches (10 - 30 cm) from the camera and remove an obstacle. (page 16, 46)

Warning and notice messages

Various messages appear on the LCD screen. Check them with the following list.

Message	Meaning/Remedy
CHARGE BATTERY (The  indicator appears.)	<ul style="list-style-type: none"> No power remaining in the rechargeable lithium ion battery. <ul style="list-style-type: none"> ➔ Charge the rechargeable lithium ion battery. (page 6) <p>Note If "CHARGE BATTERY" is displayed while using the camera, and the power is turned off automatically, stop using the rechargeable battery. Use the AC power adapter instead or replace the battery with the fully charged one.</p>
SAVING	<ul style="list-style-type: none"> While the camera is storing an image into memory, you cannot press the shutter button to record another image. <ul style="list-style-type: none"> ➔ Wait until the message goes out and press the shutter again. (page 9)
N/A IN CONTINUOUS REC MODE	<ul style="list-style-type: none"> When IMAGE QUALITY mode is set to "FINE," you cannot set CONTINUOUS mode. <ul style="list-style-type: none"> ➔ Change IMAGE QUALITY mode to "STANDARD" or "SNAPSHOT." (page 29)
N/A IN FINE IMAGE QUALITY	<ul style="list-style-type: none"> When REC MODE is set to "CONTINUOUS," you cannot set IMAGE QUALITY mode to "FINE." <ul style="list-style-type: none"> ➔ Change CONTINUOUS mode to "SINGLE," or change IMAGE QUALITY mode to "STANDARD" or "SNAPSHOT." (pages 26, 29)
NOT ENOUGH MEMORY	<ul style="list-style-type: none"> You have already used all the memories for recording. <ul style="list-style-type: none"> ➔ Delete pictures you do not want to keep, and then start recording. (page 40)
PROTECTED	<ul style="list-style-type: none"> The picture is protected. <ul style="list-style-type: none"> ➔ Cancel the protection on the PROTECT menu and then delete the picture. (page 39)
PROTECTED IMAGES REMAIN	<ul style="list-style-type: none"> Even if you select "ALL" on the DELETE menu, you cannot delete the protected image. <ul style="list-style-type: none"> ➔ Cancel the protection on the PROTECT menu and then delete the picture. (page 39)

Continue to the next page →

Message	Meaning/Remedy
⊖	<ul style="list-style-type: none"> Failed in playing back images. ➔ Set the POWER/Function dial to "OFF" and then to "PLAY" again, and play back the images again.
PRINT ERROR	<ul style="list-style-type: none"> There may be some troubles in the printing operation. ➔ Check the printer. Also check if the equipment is placed within the controllable area of the infrared ray. Then start printing again.
TRANSFER (RECV) ERROR TRANSFER (SEND) ERROR	<ul style="list-style-type: none"> Failed in infrared transfer of image data, or the equipment is out of the controllable area of the infrared ray, or no capacity remains in the built-in memory. ➔ Check the remaining memory in the receiver. Also check if the equipment is placed within the controllable area of the infrared ray. Then start transferring again.
ERROR IN IMAGE FILE	<ul style="list-style-type: none"> Image data are defective. ➔ 1 Delete the image with ⊖ mark, using the DELETE menu. (page 40) 2 If the message still appears on the screen, initialize the stored images as below. <p>Note If you initialize the stored images, all the images stored in memory are lost. Before initialization, make sure to copy the images you want to store on your computer, etc.</p>

How to initialize the stored images (INITIALIZE)

- ① Set the function dial to "CAMERA" or "PLAY."
- ② While keeping the MENU/EXECUTE jog dial pressed, press RESET at the bottom of the camera.
The INITIALIZE (image initialization) screen appears.
- ③ Select "EXECUTE" and press the MENU/EXECUTE jog dial.
"INITIALIZING" appears on the screen.
When initialization is completed, the screen returns to the CAMERA MENU or the PLAY MENU.

Specifications

System

Recording format

Digital (JPEG based)/Field recording

Video signal

NTSC color, EIA standards

Image device

1/3-inch CCD (total number of square pixels: 640 × 480), square grid, primary color filter, all the picture elements reading format

Lens

f = 4.8 mm (35 mm, when converted into a 35 mm still camera)

Panning focus (0.7 m - ∞)

Macro (0.08 m - 0.25 m)

F = 2.0

Photometric system

TTL system

Exposure control

Automatic exposure

White balance

Automatic

Data compression system • Maximum number of pictures stored

JPEG

FINE mode (120 kB) Max. 30 pictures

STANDARD (64 kB) Max. 58 pictures

SNAPSHOT (32 kB) Max. 108 pictures

Data format

Picture MD based

Full-size screen: 640 × 480 (VGA)

Screen: 80 × 60

Memory

Built-in 4MB flash memory

Flash

Controlable distance: 1.0 m - 3.0 m, automatic flash control system

Shutter speed

CAMERA **A** mode: automatic

(1/30 - 1/500)

CAMERA **M** mode: selectable (1/7.5 - 1/1000 seconds)

LCD screen

Screen size

1.8 inch (279 trio wide × 220 line long)

LCD panel

TFT

Total dot number

61,380 dots

Input and output connectors

Video output

Minijack, 1Vp-p, 75Ω unbalanced

Digital I/O port

9-pin proprietary connector

RS232C based, 9.6 Kbps - 38.4 Kbps

Infrared port

IrDA 1.1 based, 9.6 Kbps - 1.152 Mbps

General

Power requirements

External power input jack: DC 6V

AC power adapter AC-DSC1

(supplied)

Power requirements

100 to 240 V AC, 50/60 Hz

Rated input capacity

14 - 19 VA

Output voltage

DC 6V, 1.0 A

Dimensions

Approx. 1¹⁵/₁₆ × 10¹/₄ × 27⁵/₈ in.

(48 × 26 × 70 mm) (w/h/d)

Mass

Approx. 3.6 oz. (100 g)

Rechargeable lithium ion battery LIP-10 (supplied)

Maximum voltage 4.2 V DC

Nominal voltage 3.6 V DC

Capacity 750 mAh

Dimensions

Approx. 1¹/₁₆ × 26¹/₂ × 1¹/₁₆ in.

(17.0 × 67.0 × 17.2 mm) (w/h/d)

Mass 1.2 oz (35 g)

Battery life

See "Battery life" (page 7)

Power consumption

During shooting: 4.1 W

During playback: 2.8 W

Operation temperature

32°F to +104°F (0°C to +40°C)

Storage temperature

-4°F to 140°F (-20°C to 60°C)

Continue to the next page →

Dimensions

Approx. $4\frac{1}{8} \times 3\frac{1}{8} \times 1\frac{5}{8}$ in.
($102 \times 77.8 \times 40.8$ mm) (w/h/d)

Mass

Approx. 9.9 oz. (280 g) (excluding
batteries)

Supplied accessories

Video connecting cable (1)
Rechargeable lithium ion battery LIP-10
(1)
AC power adapter AC-DSC1 (1)
Carrying case (1)
Hand strap (1)
Cleaning cloth (1)
Personal computer connecting
kit (1)
 DSKIT-PC1W (for Windows)
 DSKIT-PC1M (for Macintosh)

Optional accessories

Digital color printer DPP-M55

Your dealer may not handle some of the
above listed accessories. Please ask the
dealer for detailed information about the
accessories in your country.

Design and specifications are subject to
change without notice.

Parts identification

See pages in () for more details.

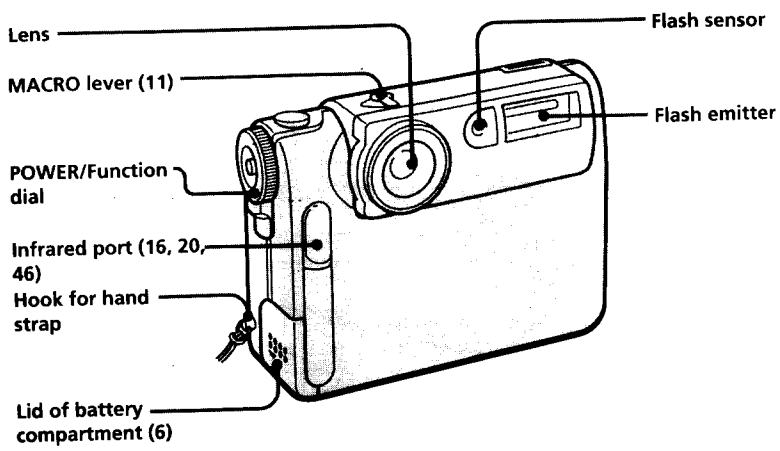

Additional information

Attaching the hand strap (supplied)

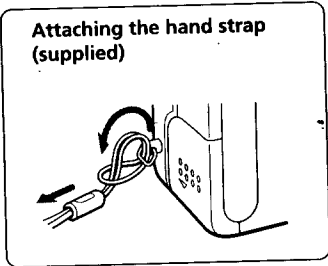

Using a tripod

Make sure that the length of the tripod screw is less than 2.2 inches (5.5 mm).

Continue to the next page →

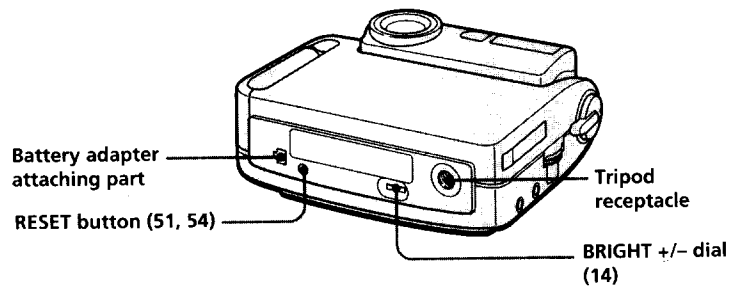
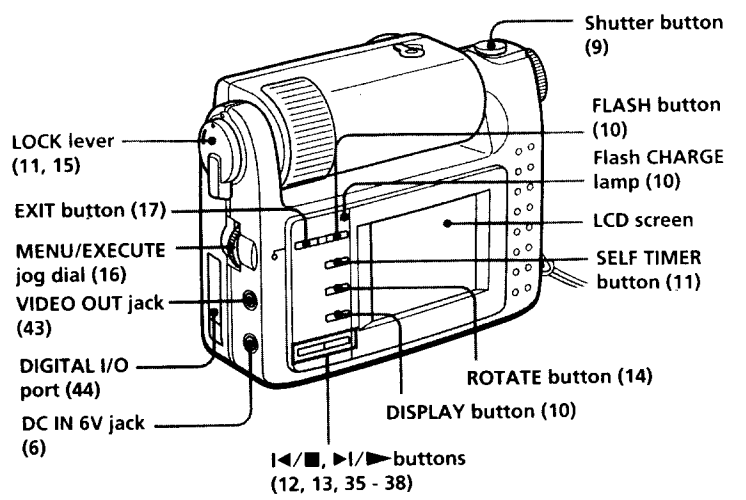

Glossary

See pages in () for more details.

AE (Automatic Exposure) (9)

The AE function enables you to shoot a subject clearly, adjusting shutter speed, iris, etc., automatically, regardless of shooting conditions.

Automatic recording (9)

Recording, using the AE (Automatic Exposure) and AWB (Automatic White Balance) function. You cannot adjust shutter speed or select CONTINUOUS recording mode, etc.

AWB (Automatic White Balance) (10)

The AWB function enables you to shoot a subject in its best tone, to meet light source or shooting conditions.

Backlighting (30, 32)

A subject to record is too dark because a strong light source such as the sun exists behind the subject. Adjust brightness of the object on the EXPOSURE and FLASH ADJ menu.

CONTINUOUS recording mode (26)

As soon as you press the shutter button, you can record multiple images continuously. Besides CONTINUOUS recording mode, there are TIME MACHINE mode and MULTI SCREEN mode in REC MODE.

Infrared data communication system (46)

The system to send/receive image data, etc., at high speed using infrared rays. Besides this camera, certain personal computers and digital printer are compatible with this system.

JPEG (29)

An image data compression system adopted by this digital still camera. JPEG is an abbreviation of Joint Photographic Experts Group who standardized a compression system for still images produced from natural pictures.

Manual recording (10)

You can adjust the shutter speed, exposure, etc., on the CAMERA MENU.

MULTI SCREEN mode (28)

As soon as you press the shutter button, you can record 9 images in succession on a single page. Useful to check high-speed action on a single page.

NTSC system (50)

Color TV system adopted by Japan, the U.S.A., etc. The pictures recorded on the NTSC system can be played back on NTSC system-based TV only.

PAL system (50)

Color TV system adopted by European countries, etc. The pictures recorded on the PAL system can be played back on PAL system-based TV only.

SEARCH screen (35)

The screen to display 6 images at a time. Useful for searching for the image you want.

SECAM system (50)

Color TV system adopted by Russia and East European countries, etc. The pictures recorded on the SECAM system can be played back on SECAM system-based TV only.

SLIDE SHOW (37)

Playing back the images in numerical order in succession automatically.

TIME MACHINE mode (27)

The mode to record some previous and next images together with the present one. Use to record the best shot among some pieces of images.

Index

- A**
AC power adapter 6, 7, 48
Adjusting brightness
 LCD screen 14
 flash 32
AE (Automatic Exposure) 9
Auto power-off function 7
Automatic recording 9
AWB (Automatic White Balance) 10
- B**
Battery life 7
- C**
Camera menu 24
Charging 6, 7
Cleaning 50
Connecting
 TV 43
 personal computer 44
 printer 43
- D**
Deleting 40
- E**
Exposure 30
- F**
Face to face shooting 11
Flash adjustment 32
- H**
Hand strap 57
- I**
Image quality 29
Indicators on the LCD screen 10
Infrared data communication 20, 46
- M**
Manual recording 10
Menu 22, 24, 25
Messages 53
Moisture condensation 50
Multi screen 28
- N**
Notice messages 53
NTSC system 50
- P**
PAL system 50
Personal computer 20, 44
Play menu 25
Playing back 13
Power sources
 house current 7
 rechargeable lithium ion battery 6
Printing 16
Printing the date and time 18
Protect 39
- R**
Rechargeable lithium ion battery 6
Recording 9
Recording mode 26
Recording in macro 11
Review 12
Remaining battery indicator 7
Rotating an image 14
- S**
Search 35
SECAM system 50
Self timer 11
Serial speed 45
Setting the date and time 33
Shutter speed 31
Slide show 37
- T**
Time machine 27
Tripod 57
Transfer 46
Troubleshooting 51
TV color system 50
- U**
Using abroad 50
- W**
Warning messages 53
- Z**
Zoom 36