

Network Media Player

The software of this player may be updated in the future. To find out details on any available updates, please visit: <http://esupport.sony.com/>



<http://www.sony.net/>

Printed on 70% or more recycled paper using VOC (Volatile Organic Compound)-free vegetable oil based ink.

4-192-726-12(1)



* 1 - 4 1 9 2 7 2 6 1 2 2 *

Printed in Malaysia

Operating Instructions
SMP-N100

© 2010 Sony Corporation

WARNING

To reduce the risk of fire or electric shock, do not expose this apparatus to rain or moisture.

To avoid electrical shock, do not open the cabinet. Refer servicing to qualified personnel only.

Batteries or batteries installed apparatus shall not be exposed to excessive heat such as sunshine, fire or the like.

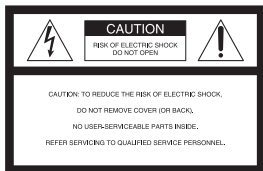

This symbol is intended to alert the user to the presence of uninsulated “dangerous voltage” within the product’s enclosure that may be of sufficient magnitude to constitute a risk of electric shock to persons.



This symbol is intended to alert the user to the presence of important operating and maintenance (servicing) instructions in the literature accompanying the appliance.

This graphical symbol is located on the AC adapter.

Precautions

- The nameplate is located on the bottom of the unit.
- To prevent fire or shock hazard, do not place objects filled with liquids, such as vases, on the apparatus.
- Install this unit so that the AC power cord can be unplugged from the wall socket immediately in the event of trouble.

Operation is subject to the following two conditions;
(1) this device may not cause interference, and
(2) this device must accept any interference received, including interference that may cause undesired operation of the device.

FCC WARNING

You are cautioned that any changes or modifications not expressly approved in this manual could void your authority to operate this equipment.

This transmitter must not be co-located or operating in conjunction with any other antenna or transmitter.

The shielded Interface cable (LAN cable) must be used with the equipment in order to comply with the limits for a digital device pursuant to Subpart B of Part 15 of FCC Rules.



This equipment has been tested and found to comply with the limits for a Class B digital device, pursuant to Part 15 of the FCC Rules. These limits are designed to provide reasonable protection against harmful interference in a residential installation. This equipment generates, uses, and can radiate radio frequency energy and, if not installed and used in accordance with the instructions, may cause harmful interference to radio communications. However, there is no guarantee that interference will not occur in a particular installation. If this equipment does cause harmful interference to radio or television reception, which can be determined by turning the equipment off and on, the user is encouraged to try to correct the interference by one or more of the following measures:

- Reorient or relocate the receiving antenna.
- Increase the separation between the equipment and receiver.
- Connect the equipment into an outlet on a circuit different from that to which the receiver is connected.
- Consult the dealer or an experienced radio/TV technician for help.

FCC Radiation Exposure

Statement:

This equipment complies with FCC radiation exposure limits set forth for uncontrolled equipment and meets the FCC radio frequency (RF) Exposure Guidelines in Supplement C to OET65. This equipment should be installed and operated with at least 20 cm and more between the radiator and person's body (excluding extremities: hands, wrists, feet and ankles).

Contains FCC ID :
AK8DWMW038

Owner's Record

The model and serial numbers are located on the bottom of the unit. Record the serial number in the space provided below. Refer to them whenever you call upon your Sony dealer regarding this product.

Model No. _____
Serial No. _____

If this product is not working properly, please call 1-866-909-7669.

Precautions

On placement

- Place the player in a location with adequate ventilation to prevent heat build-up in the player.
- Do not place any objects on the player, or do not place the player on a soft surface, such as a rug, as it may block the ventilation holes.
- Do not install this player in a confined space, such as a bookshelf or similar unit.
- Do not place the player in a location near heat sources, or in a place subject to direct sunlight, excessive dust, or mechanical shock.
- Do not place the player outdoors, in vehicles, on ships, or on other vessels.
- Do not install the player in an inclined position. It is designed to be operated in a horizontal position only.
- Do not place metal objects in front of the front panel. It may limit reception of radio waves.
- Do not place the player in a place where medical equipment is in use. It may cause a malfunction of medical instruments.
- If you use a pacemaker or other medical device, consult your physician or the manufacturer of your medical device before using the wireless LAN function.
- Do not place heavy or unstable objects on the player.
- Disconnect the AC power cord and all other cables from the player when you move the player.

On power sources

- The player is not disconnected from the AC power source as long as it is connected to the wall outlet, even if the player itself has been turned off.
- Disconnect the player from the wall outlet if you are not going to use the player for a long time. To disconnect the AC power cord, grasp the plug itself; never pull the cord.
- Observe following points to prevent the AC power cord being damaged. Do not use the AC power cord if it is damaged, as doing so may result in an electric shock or fire.
 - Do not pinch the AC power cord between the player and wall, shelf, etc.
 - Do not put anything heavy on the AC power cord or pull on the AC power cord itself.

On AC adapter

- Use the supplied AC adapter (AC-NX1W) for this player, as other adapters may cause a malfunction.
- Do not disassemble or reverse-engineer.
- Do not confine the AC adapter in a closed place such as a bookshelf or an AV cabinet.
- Do not connect the AC adapter to a traveler's electric transformer, which may generate heat and cause a malfunction.
- Do not drop or apply shock.

On adjusting volume

Do not turn up the volume while listening to a section with very low level inputs or no audio signals. If you do, your ears and the speakers may be damaged when a peak level section is played.

On cleaning

Clean the cabinet, panel, and controls with a soft cloth. Do not use any type of abrasive pad, scouring powder or solvent such as alcohol or benzene.

On replacement of parts

In the events that this player is repaired, repaired parts may be collected for reuse or recycling purposes.

On connecting to the HDMI OUT jack

Observe the following as improper handling may damage the HDMI OUT jack and the connector.

- Carefully align the HDMI OUT jack on the rear of the player and the HDMI connector by checking their shapes. Make sure the connector is not upside down or tilted.

HDMI OUT

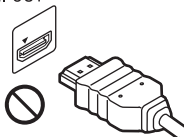

HDMI OUT

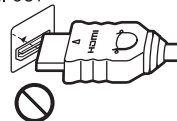

- Be sure to disconnect the HDMI cable when moving the player.



- Hold the HDMI connector straight when connecting or disconnecting the HDMI cable. Do not twist or force the HDMI connector into the HDMI OUT jack.

IMPORTANT NOTICE

Caution: This player is capable of holding a still video image or on-screen display image on your television screen indefinitely. If you leave the still video image or on-screen display image displayed on your TV for an extended period of time you risk permanent damage to your television screen. Plasma display panel televisions and projection televisions are susceptible to this.

If you have any questions or problems concerning your player, please consult your nearest Sony dealer.

Important Safety Instructions

- 1) Read these instructions.
- 2) Keep these instructions.
- 3) Heed all warnings.
- 4) Follow all instructions.
- 5) Do not use this apparatus near water.
- 6) Clean only with dry cloth.
- 7) Do not block any ventilation openings. Install in accordance with the manufacturer's instructions.
- 8) Do not install near any heat sources such as radiators, heat registers, stoves, or other apparatus (including amplifiers) that produce heat.
- 9) Do not defeat the safety purpose of the polarized or grounding-type plug. A polarized plug has two blades with one wider than the other. A grounding type plug has two blades and a third grounding prong. The wide blade or the third prong are provided for your safety. If the provided plug does not fit into your outlet, consult an electrician for replacement of the obsolete outlet.
- 10) Protect the power cord from being walked on or pinched particularly at plugs, convenience receptacles, and the point where they exit from the apparatus.

- 11) Only use attachments/accessories specified by the manufacturer.
- 12) Use only with the cart, stand, tripod, bracket, or table specified by the manufacturer, or sold with the apparatus. When a cart is used, use caution when moving the cart/apparatus combination to avoid injury from tip-over.



- 13) Unplug this apparatus during lightning storms or when unused for long periods of time.
- 14) Refer all servicing to qualified service personnel. Servicing is required when the apparatus has been damaged in any way, such as power-supply cord or plug is damaged, liquid has been spilled or objects have fallen into the apparatus, the apparatus has been exposed to rain or moisture, does not operate normally, or has been dropped.

Table of Contents

WARNING	2
Precautions	3
Guide to Parts and Controls	6

Hookups and Settings

Step 1: Preparing the Player	9
Step 2: Connecting the Player	10
Step 3: Easy Setup	12
Connecting to the Network	13

Playback

Playing via a Network	14
Playing from a USB Device	15
Available Options	16

Settings and Adjustments

Using the Settings Displays	17
Network Update	18
Screen Settings	18
Audio Settings	19
Parental Control Settings	20
System Settings	21
Network Settings	21
Easy Setup	22
Resetting	22

Additional Information

Troubleshooting	23
Specifications	26
Index	30

Guide to Parts and Controls

Front panel

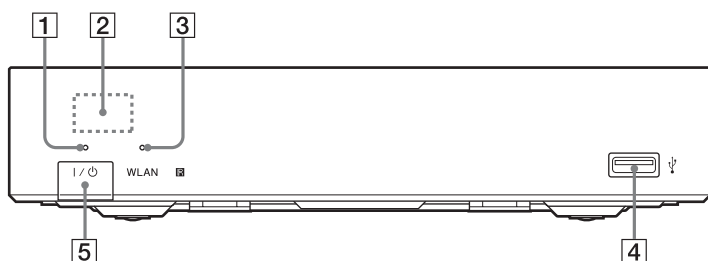

1 Power indicator

Lights up when the player is turned on.

2 Remote sensor

3 WLAN indicator

Lights up when using a wireless LAN.

4 USB (USB) jack

Connect a USB device to this jack.

5 I/O (on/standby)

Turns on the player, or sets to standby mode.

Rear panel

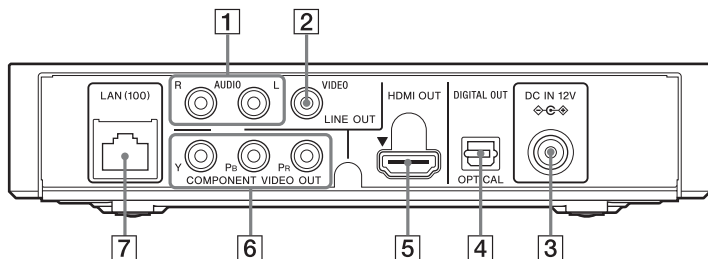

1 LINE OUT (R-AUDIO-L) jacks

2 LINE OUT (VIDEO) jack

3 DC IN 12V (AC adapter input) jack

4 DIGITAL OUT (OPTICAL) jack

5 HDMI OUT jack

6 COMPONENT VIDEO OUT (Y, P_B, P_R) jacks

7 LAN (100) terminal

Remote

The available functions of the remote differ depending on the file or the situation.

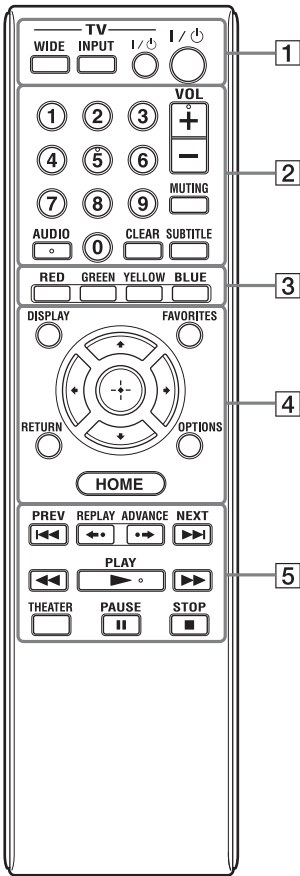

Number 5, AUDIO, VOL +/–, and ► PLAY buttons have a tactile dot. Use the tactile dot as a reference when operating the player.

The player automatically returns to standby mode

If any button on the remote is not pressed for more than 30 minutes, the player automatically returns to standby mode.

1 -TV- WIDE

Changes the screen format.

-TV- INPUT

Switches between TV and other input sources.

-TV- I/⏻ (on/standby)

Turns on the TV, or sets to standby mode.

I/⏻ (on/standby)

Turns on the player, or sets to standby mode.

2 Number buttons (0 - 9)

Enters the title/chapter numbers, etc.

VOL +/-

Adjusts the TV volume.

MUTING

Mutes the sound.

AUDIO

Selects the language track when multi-lingual tracks are recorded.

CLEAR

Erases input characters. Each time you press the button, one character is erased.

SUBTITLE

Selects the subtitle language when multi-lingual subtitles are recorded.

3 Color buttons (RED/GREEN/YELLOW/BLUE)

Short cut keys for interactive functions.

4 DISPLAY (page 14)

Displays the playback information on the screen.

FAVORITES (page 16)

Displays the Internet content added to the Favorites List. You can save up to 18 of your favorite Internet content programs.

OPTIONS (page 16)

The options menu that can be selected appears on the screen.

HOME

Enters the player's home menu.

Displays the wall paper when pressed on the category icon of the home menu.

RETURN

Returns to the previous display.



Moves the highlight to select a displayed item.

Center button (ENTER)

Enters the selected item.

5 ◀◀ PREV/NEXT ▶▶

Skips to the previous/next chapter, track, or file.



Depending on the contents, these buttons may not function.

◀◀/▶▶ (fast reverse/fast forward)

- Fast reverses/fast forwards when pressed during playback. Each time you press the button during playback of videos, the search speed changes.
- Plays in slow motion, when pressed for more than one second in pause mode.
- Plays one frame at a time, when pressed briefly in pause mode.

▶▶ PLAY

Starts or re-starts playback.

THEATER (page 27)

Switches to the optimum video mode for watching movies automatically.

The THEATER button functions only when connected to a Sony Theater Mode-compatible AV amplifier (receiver) or Sony Theater Mode-compatible TV.

|| PAUSE

Pauses or re-starts playback.

■ STOP

Stops playback and remembers the stop point (resume point).

The resume point for a title/track is the last point you played or the last photo for a photo folder.

Home menu display

The home menu appears when you press HOME. Select a category using ◀/▶. Select an item using ↑/↓, and press ENTER.

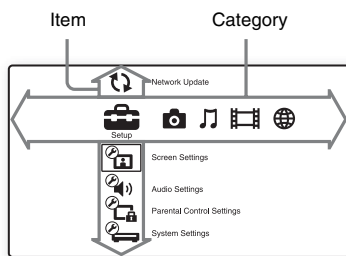

- (Setup): Adjusts the player settings.
- (Photo): Displays photos.
- (Music): Plays music.
- (Video): Plays videos.
- (Network): Displays network items.

Step 1: Preparing the Player

Checking the supplied accessories

Check that you have the following items:

- Audio/video cable (phono plug x3) (1)
- AC power cord (1)
- AC adapter (1)
- Remote control (remote) (1)
- Size AA (R6) batteries (2)

Preparing the remote

Insert two Size AA (R6) batteries by matching the ⊕ and ⊖ ends on the batteries to the markings inside the battery compartment.

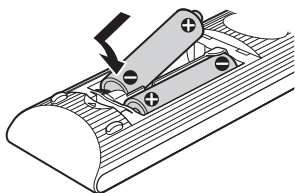

Step 2: Connecting the Player

Do not connect the AC power cord until you have made all the connections.

Connecting to your TV

Select one of the following connection methods according to the input jacks on your TV. Match the color of the plug to that of the jack when connecting.

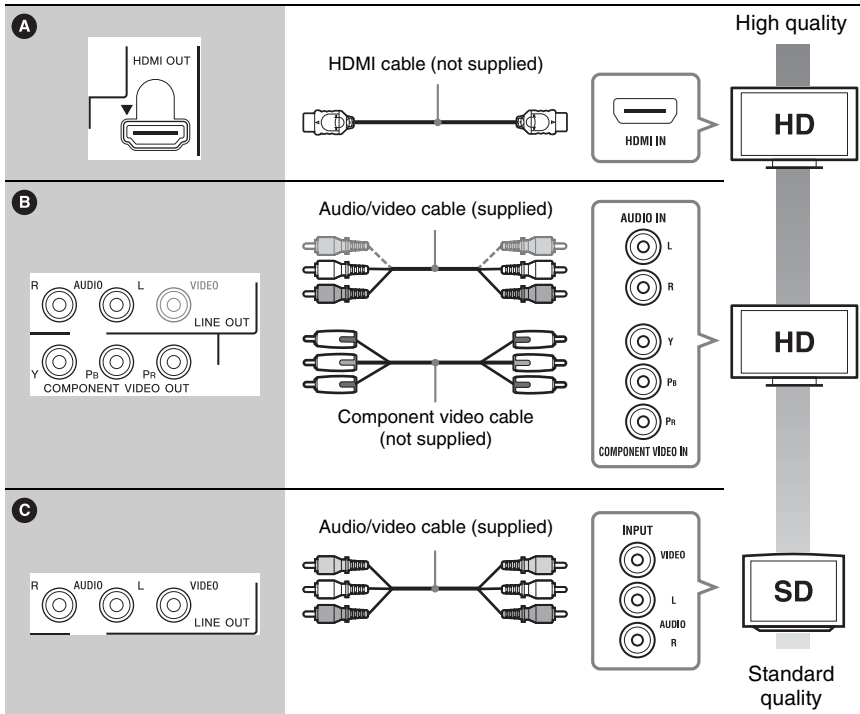
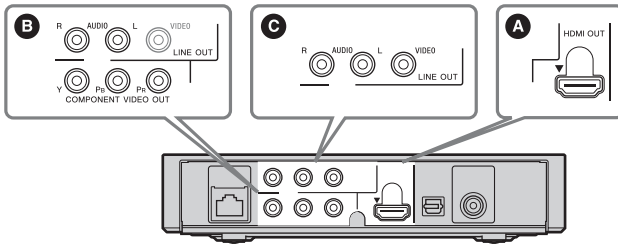

⚡ Do not connect the player through a VCR. Video signals fed through VCRs may be affected by copyright protection systems and the picture will be distorted on the television.

Connecting to your AV amplifier (receiver)

Select one of the following connection methods according to the input jacks on your AV amplifier (receiver). When you select **B**, make the appropriate settings in the “Audio Settings” setup (page 19).

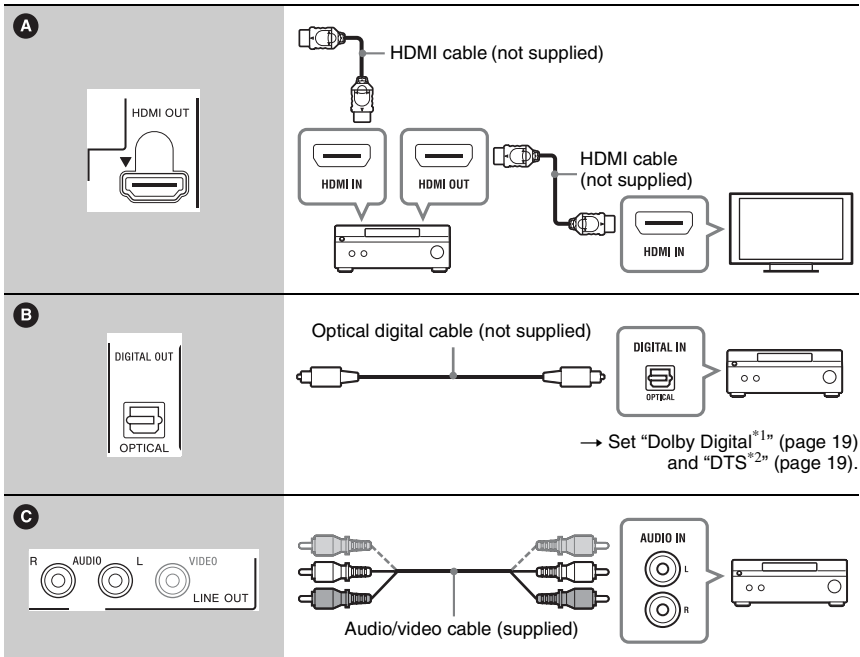
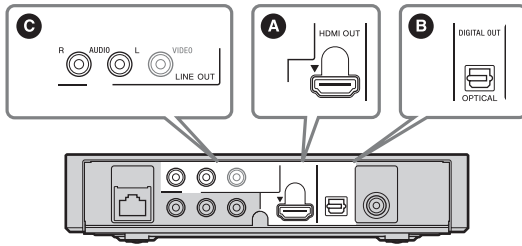

^{*1} Manufactured under license from Dolby Laboratories. Dolby, Pro Logic, and the double-D symbol are trademarks of Dolby Laboratories.

^{*2} Manufactured under license under U.S. Patent #'s: 5,451,942; 5,956,674; 5,974,380; 5,978,762; 6,487,535 & other U.S. and worldwide patents issued & pending. DTS and the Symbol are registered trademarks, & DTS 2.0+ Digital Out and the DTS logos are trademarks of DTS, Inc. Product includes software. © DTS, Inc. All Rights Reserved.

Step 3: Easy Setup

When turned on for the first time

Wait for a short while before the player turns on and starts “Easy Setup.”

1 Connect the supplied AC adapter and AC power cord in the numeric order shown below.

When removing them, do so in reverse order.

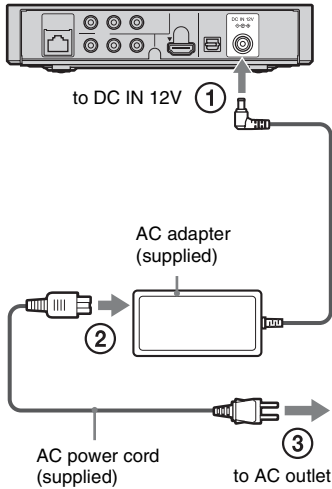

After connecting, wait for about 30 seconds until the player enters standby.

2 Press I/⏻ to turn on the player.

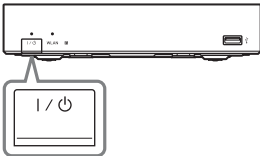

3 Turn on the TV, then switch the input selector on your TV so that the signal from the player appears on your TV screen.

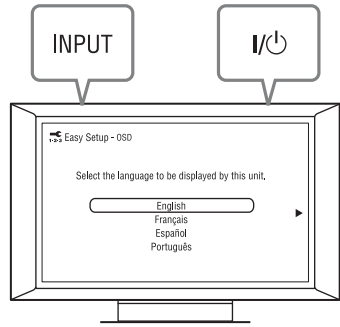

4 Perform “Easy Setup.”

Follow the on-screen instructions to make the basic settings using ←/↑/↓/→ and ENTER on the remote.

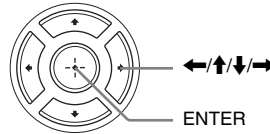

Connecting to the Network

Wired Setup

Use a LAN cable to connect to the LAN (100) terminal on the player.

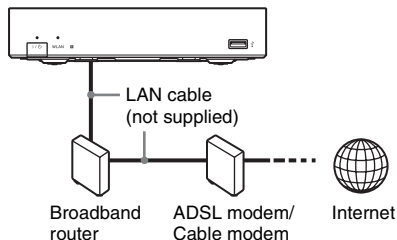

To set the network settings

Select “Network Settings,” “Internet Settings,” then “Wired Setup” (page 21), and follow the on-screen instructions to complete the setup.

Wireless Setup

Use a wireless LAN that is built into the player.

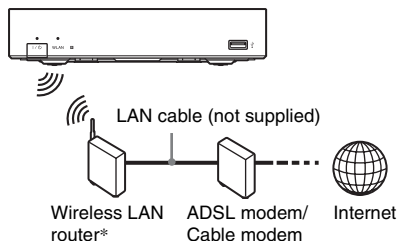

* Use a wireless LAN router supporting 802.11b/g or 802.11b/g/n.

To set the network settings

Select “Network Settings,” “Internet Settings,” then “Wireless Setup” (page 21), and follow the on-screen instructions to complete the setup.

Playback

Playing via a Network

Streaming BRAVIA Internet Video

BRAVIA Internet Video serves as a gateway delivering the selected Internet content and a variety of on-demand entertainment straight to your player.

1 Prepare for BRAVIA Internet Video.

Connect the player to a network (page 13).

2 Select (Video), (Music), or (Photo) on the home menu using /.

3 Select an Internet content program icon using /, and press ENTER.





When an Internet content list has not been acquired, an unacquired icon or a new icon is displayed.

To use the control panel

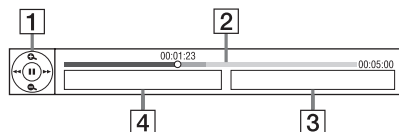
The control panel appears when the video file starts playing. The displayed items may differ depending on Internet content programs.

To display again, press DISPLAY.



- 1** Control display
Press /// or ENTER for playback operations.
- 2** Playing status bar
Status bar, Cursor indicating the current position, Playing time, Duration of the video file
- 3** The next video file name
- 4** The currently selected video file name

Playing files on a DLNA server

You can play video/music/photo files on your home server, such as a DLNA certified PC by connecting the player to the home network. For playable files on a DLNA server, see “Playable types of files” (page 26).

1 Prepare for playing files on a DLNA server.

- Connect the player to a network (page 13).
- Set “Connection Server Settings” (page 21).

2 Select (Video), (Music), or (Photo) on the home menu using .

3 Select a DLNA server using , and press ENTER.

The file list or folder list appears.

Playing from a USB Device

You can play video/music/photo files on the connected USB device.

For playable USB devices, see “Playable types of files” (page 26).

1 Connect the USB device to the USB jack on the player.

Refer to the instruction manual supplied with the USB device before connecting.

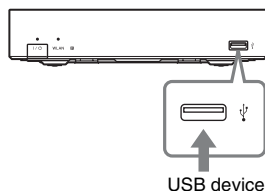

2 Select (Video), (Music), or (Photo) on the home menu using .

3 Select (USB device) using , and press ENTER.

Available Options

Various settings and playback operations are available by pressing **OPTIONS**. The available items differ depending on the situation.

Common options

Items	Details
Repeat Setting	Sets the repeat mode.
Favorites List	Displays the Favorites List.
Play/Stop	Starts or stops the playback.
Play from beginning	Plays the item from the beginning.
Add to Favorites	Adds Internet content to the Favorites List.
Remove from Favorites	Removes Internet content from the Favorites List.

⏏ (Video) only

Items	Details
AV SYNC	Adjusts the gap between picture and sound, by delaying the sound output in relation to the picture output (0 to 120 milliseconds).
Video Settings	<ul style="list-style-type: none"> • Picture Quality Mode: Selects the picture settings for different lighting environments. • FNR: Reduces the random noise appearing in the picture. • BNR: Reduces the mosaic-like block noise in the picture. • MNR: Reduces minor noise around the picture outlines (mosquito noise).
Pause	Pauses the playback.
Chapter Search	Searches for a chapter and starts playback from the beginning.
IP Content Noise Reduction	Adjusts the picture quality of Internet content.

🎵 (Music) only

Items	Details
Add Slideshow BGM	Registers music files in the USB memory as slideshow background music (BGM).





📷 (Photo) only









Items	Details
Slideshow Speed	Changes the slideshow speed.
Slideshow Effect	Sets the effect for slideshows.
Slideshow BGM	<ul style="list-style-type: none"> • Off: Turns off the function. • My Music from USB: Sets the music files registered in "Add Slideshow BGM." If no music file is registered, "(Not registered)" is displayed.
Slideshow	Plays a slideshow.
Rotate Left	Rotates the photo counterclockwise by 90 degrees.
Rotate Right	Rotates the photo clockwise by 90 degrees.

Settings and Adjustments

Using the Settings Displays

Select  (Setup) on the home menu when you need to change the settings of the player. The default settings are underlined.

- 1 Select  (Setup) on the home menu using / .
- 2 Select the setup category icon using / , and press ENTER.

Icon	Explanation
	Network Update (page 18) Updates the software of the player.
	Screen Settings (page 18) Makes the video settings according to the type of connecting jacks.
	Audio Settings (page 19) Makes the audio settings according to the type of connecting jacks.
	Parental Control Settings (page 20) Makes detailed settings for the Parental Control function.
	System Settings (page 21) Makes the player-related settings.
	Network Settings (page 21) Makes detailed settings for the Internet and network.
 1·2·3	Easy Setup (page 22) Re-runs the Easy Setup to make the basic settings.
	Resetting (page 22) Resets the player to the factory settings.

Network Update

Select “OK” to update the player’s software via the network.



- We recommend the network update every 2 months or so.
- For information about update functions, visit the following website:
<http://esupport.sony.com/>

Screen Settings

TV Type

<u>16:9</u>	Select this when connecting to a wide-screen TV or a TV with a wide mode function.
4:3	Select this when connecting to a 4:3 screen TV without a wide mode function.

Screen Format

<u>Original</u>	Select this when connecting to a TV with a wide mode function. Displays a 4:3 screen picture in 16:9 aspect ratio even on a wide-screen TV.
Fixed Aspect Ratio	Changes the picture size to fit the screen size with the original picture aspect ratio.

Cinema Conversion Mode

<u>Auto</u>	Normally select this. The player automatically detects whether the material is video-based or film-based, and switches to the appropriate conversion method.
Video	The conversion method suited for video-based material will always be selected regardless of the material.

Output Video Format

<u>HDMI</u>	Normally select “Auto.”
Component Video	Select the resolution that suits your TV.
Video	Automatically sets the lowest resolution.



- When connecting the HDMI OUT jack and other video output jacks at the same time, select “Component Video.”
- If no picture appears when setting “HDMI” or “Component Video” resolution, try another resolution setting.

YCbCr/RGB (HDMI)

<u>Auto</u>	Automatically detects the connected TV type, and switches to the matching color setting.
YCbCr (4:2:2)	Outputs YCbCr 4:2:2 video signals.
YCbCr (4:4:4)	Outputs YCbCr 4:4:4 video signals.
RGB	Outputs RGB video signals.

HDMI Deep Color Output

<u>Auto</u>	Normally select this.
12bit	Outputs 12bit/10bit video signals when the connected TV is compatible with Deep Color.
10bit	
Off	Select this when the picture is unstable or colors appear unnatural.

Pause Mode

<u>Auto</u>	Normally select this. Dynamic moving pictures appear without blurring.
Frame	Displays static pictures at high resolution.



Audio Settings

Audio (HDMI)

<u>Auto</u>	Normally select this. Outputs audio signals according to the status of the connected HDMI device.
PCM	Outputs PCM signals from the HDMI OUT jack.

Dolby Digital

Downmix PCM	Converts to output Linear PCM signals. Select this when connecting an audio device without a built-in Dolby Digital decoder.
<u>Dolby Digital</u>	Select this when connecting an audio device with a built-in Dolby Digital decoder.

DTS

Downmix PCM	Converts to output Linear PCM signals. Select this when connecting to an audio device without a built-in DTS decoder.
<u>DTS</u>	Select this when connecting to an audio device with a built-in DTS decoder.

Audio DRC

<u>Auto</u>	Performs playback at the dynamic range specified by the current file.
Standard	Performs playback at a standard compression level.
Wide Range	No compression works. A more dynamic sound is produced.

Downmix

<u>Surround</u>	Outputs audio signals with surround effects. Select this when connecting an audio device that supports Dolby Surround (Pro Logic) or DTS Neo:6.
Stereo	Outputs audio signals without surround effects. Select this when connecting an audio device that does not support Dolby Surround (Pro Logic) or DTS Neo:6.

Parental Control Settings

Password

Sets or changes the password for the Parental Control function. A password allows you to set a restriction on Internet video playback.

Parental Control Area Code

Playback of some Internet videos can be limited according to the geographic area. Scenes may be blocked or replaced with different scenes. Follow the on-screen instructions and enter your four-digit password.

Internet Video Parental Control

Playback of some Internet videos can be limited according to the age of the users. Scenes may be blocked or replaced with different scenes. Follow the on-screen instructions and enter your four-digit password.

Internet Video Unrated

<u>Allow</u>	Allows the playback of unrated Internet videos.
Block	Blocks the playback of unrated Internet videos.

System Settings

OSD

Selects your language for the player on-screen displays.

Control for HDMI

<u>On</u>	Allows you to use the “Control for HDMI” function (page 27).
Off	Turns off the function.

Auto Display

<u>On</u>	Automatically displays information on the screen when changing the viewing titles, picture modes, audio signals, etc.
Off	Displays information only when you press DISPLAY.

Screen Saver

<u>On</u>	Turns on the screen saver function. The screen saver image appears when you do not use the player for more than 10 minutes while an on-screen display is displayed.
Off	Turns off the function.

Software Update Notification

<u>On</u>	Sets the player to inform you of newer software version information (page 18).
Off	Turns off the function.

DivX(R) VOD

For details, visit the following website:
vod.divx.com

System Information

Displays the player’s software version information and the MAC address.

Network Settings

Internet Settings

Connect the player to the network beforehand. For details, see “Connecting to the Network” (page 13).

<u>View Network Status</u>	Displays the current network status.
<u>Wired Setup</u>	Select this when you connect to a broadband router directly.
<u>Wireless Setup</u>	Select this when you use a wireless LAN router. For further details, visit the following website and check the FAQ contents: http://esupport.sony.com/

Network Connection Diagnostics

You can run the network diagnostic to check if the network connection has been made properly.

Connection Server Settings

Sets whether or not to display the connected server.

BD Remote Device Registration

Registers your “BD Remote” device. Some mobile devices can install the “BD Remote” application. For the latest compatible devices, visit the following website:
<http://esupport.sony.com/>

Registered BD Remote Devices

Displays a list of your registered “BD Remote” devices.



1·2·3 Easy Setup

Re-runs the “Easy Setup” to make the basic settings. Follow the on-screen instructions.



Resetting

Reset to Factory Default Settings

You can reset the player settings to the factory default by selecting the group of settings. All the settings within the group will be reset.

Initialize Personal Information

You can erase your personal information stored in the player.

Additional Information

Troubleshooting

If you experience any of the following difficulties while using the player, use this troubleshooting guide to help remedy the problem before requesting repairs. Should any problem persist, consult your nearest Sony dealer.

Power

The power does not turn on.

- ➔ Check that the AC adapter and AC power cord are connected securely.

Picture

There is no picture or the picture is not output correctly.

- ➔ Check that all the connecting cables are securely connected (page 10).
- ➔ Switch the input selector on your TV to display the signal from the player.
- ➔ Connect the player to your TV using the LINE OUT (VIDEO) jack, and check the “Output Video Format” settings in the “Screen Settings” setup (page 18).
- ➔ For HDMI connections, try the following:
 - ① Turn the player off and on again.
 - ② Turn the connected equipment off and on again.
 - ③ Disconnect and then reconnect the HDMI cable.
- ➔ The HDMI OUT jack is connected to a DVI device that does not support copyright protection technology.
- ➔ For HDMI connections, check the “Output Video Format” settings in the “Screen Settings” setup (page 18).

The display language on the screen switches automatically when connected to the HDMI OUT jack.

- ➔ When “Control for HDMI” is set to “On” (page 21), the display language on the screen automatically switches according to the language setting of the connected TV (if you change the setting on your TV, etc.).

Sound

There is no sound or the sound is not output correctly.

- ➔ Check that all the connecting cables are securely connected (page 10).
- ➔ Switch the input selector on your AV amplifier (receiver) so that the audio signals of the player are output from your AV amplifier (receiver).
- ➔ If the audio signal does not come through the DIGITAL OUT (OPTICAL)/HDMI OUT jack, check the audio settings (page 19).
- ➔ For HDMI connections, try the following:
 - ① Turn the player off and on again.
 - ② Turn the connected equipment off and on again.
 - ③ Disconnect and then reconnect the HDMI cable.
- ➔ For HDMI connections, if the player is connected to a TV through an AV amplifier (receiver), try connecting the HDMI cable directly to the TV. Refer also to the instruction manual supplied with the AV amplifier (receiver).
- ➔ The HDMI OUT jack is connected to a DVI device (DVI jacks do not accept audio signals).
- ➔ The device connected to the HDMI OUT jack does not support the audio format of the player. Check the audio settings (page 19).

USB device

The player does not detect a USB device connected to the player.

- ➔ Make sure that the USB device is securely connected to the USB jack.
- ➔ Check if the USB device or a cable is damaged.
- ➔ Check if the USB device is on.
- ➔ If the USB device is connected via a USB hub, connect the USB device directly to the player.

BRAVIA Internet Video

The picture/sound is poor/certain programs display a loss of detail, especially during fast-motion or dark scenes.

- ➔ Picture/sound quality may be poor depending on Internet content programs.
- ➔ Picture/sound quality may be improved by changing the connection speed. We recommend the connection speed of at least 2.5 Mbps for standard definition video (10 Mbps for high definition video).
- ➔ Not all videos will contain sound.

The picture is small.

- ➔ Press **↑** to zoom in.

Network connection

The player cannot connect to the network.

- ➔ Check the network connection (page 13) and the network settings (page 21).

You cannot connect your PC to the Internet after “Wi-Fi Protected Setup (WPS)” is performed.

- ➔ The wireless settings of the router may change automatically if you use the Wi-Fi Protected Setup function before adjusting the settings of the router. In this case, change the wireless settings of your PC accordingly.

You cannot connect the player to the wireless LAN router.

- ➔ Check if the wireless LAN router is on.
- ➔ Depending on the surrounding environment, such as the wall material, radio wave receiving condition, or obstacles between the player and the wireless LAN router, the communication distance may be shortened. Move the player and the wireless LAN router closer to each other.
- ➔ Devices that use a 2.4 GHz frequency band, such as a microwave, Bluetooth, or digital cordless device, may interrupt the communication. Move the player away from such devices, or turn off such devices.

The desired wireless router is not detected even if “Scan” is performed.

- ➔ Press RETURN to return to the previous screen, and try “Scan” again. If the desired wireless router is still not detected, press RETURN to select “Manual registration.”

The message “A new software version has been found on the network. Perform update under “Network Update.”” appears on the screen when turning the player on.

- ➔ See “Network Update” (page 18) to update the player to a newer software version.

BRAVIA Sync (“Control for HDMI”)

The “Control for HDMI” function does not work (BRAVIA Sync).

- ➔ Check that “Control for HDMI” is set to “On” (page 21).
- ➔ If you change the HDMI connection, turn the player off and on again.
- ➔ If power failure occurs, set “Control for HDMI” to “Off,” then set “Control for HDMI” to “On” (page 21).
- ➔ Check the following and refer to the instruction manual supplied with the component.
 - the connected component is compatible with the “Control for HDMI” function.
 - the connected component’s setting for the “Control for HDMI” function is correct.
- ➔ When you connect the player to a TV through an AV amplifier (receiver),
 - if the AV amplifier (receiver) is not compatible with the “Control for HDMI” function, you may be unable to control the TV from the player.
 - if you change the HDMI connection, disconnect and reconnect the AC power cord, or a power failure occurs, try the following: ①Switch the input selector of the AV amplifier (receiver) so that the picture from the player appears on the TV screen. ②Set “Control for HDMI” to “Off,” then set “Control for HDMI” to “On” (page 21). Refer to the instruction manual supplied with the AV amplifier (receiver).

Others

Playback does not start from the beginning of content.

- ➔ Press OPTIONS, and select “Play from beginning.”

Playback does not start from the resume point where you last stopped playing.

- ➔ The resume point may be cleared from memory when
 - you disconnect the USB device.
 - you play other content.
 - you turn off the player.

The player does not respond to any button.

- ➔ Hold down I/⏻ on the player for more than 10 seconds until the indicators on the front panel turn off.
If the player still does not respond to any button, disconnect then reconnect the AC power cord.

Specifications

Inputs and outputs

(Jack name:

Jack type/Output level/Load impedance)

LINE OUT R-AUDIO-L:

Phono jack/2 V_{rms}/10 kilohms

DIGITAL OUT (OPTICAL):

Optical output jack/−18 dBm
(wave length 660 nm)

HDMI OUT:

HDMI 19-pin standard connector

COMPONENT VIDEO OUT

(Y, P_B, P_R):

Phono jack/Y: 1.0 V_{p-p}/
P_B, P_R: 0.7 V_{p-p}/75 ohms

LINE OUT VIDEO:

Phono jack/1.0 V_{p-p}/75 ohms

LAN (100):

100BASE-TX Terminal

USB:

USB jack Type A (For connecting a USB memory, hard disk drive, memory card reader, digital still camera, and digital video camera)

DC IN:

12 V DC

Wireless

Wireless LAN standard:

IEEE802.11b/g/n

Frequency range:

2.4 GHz band: Channels 1-11

Modulation:

DS-SS Modem and OFDM Modem

General

Power requirements:

AC adapter: 110 – 240 V AC, 50/60 Hz

Power consumption (approx.):

14 W

Dimensions (approx.):

185 mm × 193 mm × 40 mm
(17 ³/₈ in. × 7 ⁵/₈ in. × 1 ⁵/₈ in.)
(width/depth/height) incl. projecting parts

Mass (approx.):

680 g (1 lb 8 oz)

Operating temperature:

5 °C to 35 °C (41 °F to 95 °F)

Operating humidity:

25 % to 80 %

Supplied accessories

See page 9.

Specifications and design are subject to change without notice.

Playable types of files

Video

File format	Extensions
MPEG-1 Video/ PS ^{*1*5}	“.mpg,” “.mpeg,” “.m2ts,” “.mts”
MPEG-2 Video/PS, TS ^{*1*6}	
DivX ^{*2}	“.avi,” “.divx”
MPEG-4 AVC ^{*1*5}	“.mkv,” “.mp4,” “.m4v,” “.m2ts,” “.mts”
WMV9 ^{*1*5}	“.wmv,” “.asf”
AVCHD ^{*5}	*3

Music

File format	Extensions
MP3 (MPEG-1 Audio Layer III)	“.mp3”
AAC ^{*1*4*5}	“.m4a”
WMA9 Standard ^{*1*4*5}	“.wma”
LPCM	“.wav”

Photo

File format	Extensions
JPEG	“.jpg,” “.jpeg”

^{*1} The player does not play coded files such as DRM.

^{*2} ABOUT DIVX VIDEO: DivX[®] is a digital video format created by DivX, Inc. This is an official DivX Certified device that plays DivX video. Visit www.divx.com for more information and software tools to convert your files into DivX video.

ABOUT DIVX VIDEO-ON-DEMAND: This DivX Certified[®] device must be registered in order to play DivX Video-on-Demand (VOD) content. To generate the registration code, locate the DivX VOD section in the device setup menu. Go to vod.divx.com with this code to complete the registration process and learn more about DivX VOD.

- *3 The player plays AVCHD format files that are recorded on a digital video camera, etc.
- *4 The player does not play coded files such as Lossless.
- *5 The player does not play this file format on a DLNA server.
- *6 The player can only play standard definition video on a DLNA server.



- Some files may not play depending on the file format, file encoding, recording condition, or DLNA server condition.
- Some files edited on a PC may not play.
- The player can recognize the following files or folders in USB devices:
 - up to folders in the 5th tree
 - up to 500 files in a single tree
- The player can recognize the following files or folders stored in the DLNA server:
 - up to folders in the 20th tree
 - up to 999 files in a single tree
- Some USB devices may not work with this player.
- The player can recognize Mass Storage Class (MSC) devices (such as flash memory or an HDD), Still Image Capture Device (SICD) class devices and 101 keyboard (USB jack only).
- To avoid data corruption or damage to the USB memory or devices, turn the player off when connecting or removing the USB memory or devices.

About the BRAVIA Sync features (for HDMI connections only)

By connecting Sony components that are compatible with the “Control for HDMI” function with an HDMI cable (not supplied), operation is simplified as below:

- One-Touch Play
With one touch of the following buttons, the connected TV turns on and the input selector on the TV is switched to the player automatically.
 - HOME: The home menu appears automatically (page 7, 14, 17).
 - PLAY: Playback starts automatically.
- System Power-Off
When you turn off the TV using -TV- or the power button on the TV’s remote, the player and HDMI-compatible components turn off automatically.

- Theater
When you press THEATER, the player automatically switches to the optimum video mode for watching movies. When connected with a Sony AV amplifier (receiver) using the HDMI cable, the speaker output also switches automatically. When connected with a Theater Mode-compatible TV using the HDMI cable, the TV’s video mode switches to Theater Mode. Press the button again to return to the original setting.
- Language Follow
When you change the language for the on-screen display on your TV, the player’s language for the on-screen display is also changed after turning the player off and on.

To prepare for the BRAVIA Sync features

Set “Control for HDMI” to “On” in the “System Settings” setup (page 21). For details on settings of your TV or other connected components, refer to the instruction manual supplied with the TV or components.



- When connecting the Sony TV that is compatible with the “Control for HDMI” Easy Setting function using the HDMI cable, the “Control for HDMI” setting of the player automatically switches to “On” if the “Control for HDMI” setting on the connected TV is set to “On.” Refer to the instruction manual supplied with the TV.
- When connecting the Sony TV that is compatible with the BRAVIA Sync features using the HDMI cable, you can control the basic functions of the player with the TV’s remote if the “Control for HDMI” setting on the connected TV is set to “On.” Refer to the instruction manual supplied with the TV.



Depending on the connected component, the “Control for HDMI” function may not work. Refer to the instruction manual supplied with the component.

About wireless LAN security

Since communication via the wireless LAN function is established by radio waves, the wireless signal may be susceptible to interception. To protect wireless communication, this player supports various security functions. Be sure to correctly configure the security settings in accordance with your network environment.

◆ No Security

Although you can easily make settings, anyone can intercept wireless communication or intrude into your wireless network, even without any sophisticated tools. Keep in mind that there is a risk of unauthorized access or interception of data.

◆ WEP

WEP applies security to communications to prevent outsiders from intercepting communications or intruding into your wireless network. WEP is a legacy security technology that enables older devices, which do not support TKIP/AES, to be connected.

◆ WPA-PSK (TKIP), WPA2-PSK (TKIP)

TKIP is a security technology developed to correct for the deficiencies of WEP. TKIP assures a higher security level than WEP.

◆ WPA-PSK (AES), WPA2-PSK (AES)

AES is a security technology that uses an advanced security method that is distinct from WEP and TKIP.

AES assures a higher security level than WEP or TKIP.

Copyrights and Trademarks

- “AVCHD” and the “AVCHD” logo are trademarks of Panasonic Corporation and Sony Corporation.
- “XMB,” “XMB,” and “cross media bar” are trademarks of Sony Corporation and Sony Computer Entertainment Inc.
- This product incorporates High-Definition Multimedia Interface (HDMI™) technology. HDMI, the HDMI logo and High-Definition Multimedia Interface are trademarks or registered trademarks of HDMI Licensing LLC.
- “x.v.Color” and “x.v.Color” logo are trademarks of Sony Corporation.
- “BRAVIA” is a trademark of Sony Corporation.
- “PhotoTV HD” and the “PhotoTV HD” logo are trademarks of Sony Corporation.
- MPEG Layer-3 audio coding technology and patents licensed from Fraunhofer IIS and Thomson.
- DivX®, DivX Certified® and associated logos are registered trademarks of DivX, Inc. and are used under license.
- Windows Media is either a registered trademark or trademark of Microsoft Corporation in the United States and/or other countries. This product is protected by certain intellectual property rights of Microsoft Corporation. Use or distribution of such technology outside of this product is prohibited without a license from Microsoft or an authorized Microsoft subsidiary.
- The Wi-Fi CERTIFIED™ Logo is a certification mark of the Wi-Fi Alliance.
- The Wi-Fi Protected Setup™ Mark is a mark of the Wi-Fi Alliance.
- “Wi-Fi CERTIFIED™” and “Wi-Fi Protected Setup™” are trademarks of the Wi-Fi Alliance.
- DLNA®, the DLNA Logo and DLNA CERTIFIED® are trademarks, service marks, or certification marks of the Digital Living Network Alliance.
- Other system and product names are generally trademarks or registered trademarks of the manufacturers. ™ and ® marks are not indicated in this document.

Code numbers of controllable TVs

While holding down -TV- **I**/**⏻**, enter the TV's manufacturer code using the number buttons.

Manufacturer	Code number
Sony	01 (default)
Hitachi	02
LG/Goldstar	04
Loewe	45
Mitsubishi/MGA	13
Panasonic	19
Philips	21
Pioneer	16
RCA	10
Samsung	20
Sharp	18
Toshiba	07

Parental control/area code

For details, see "Parental Control Area Code" (page 20).

Number, Area (Code)

2044, Argentina (ar)
2047, Australia (au)
2046, Austria (at)
2057, Belgium (be)
2070, Brazil (br)
2090, Chile (cl)
2092, China (cn)
2093, Colombia (co)
2115, Denmark (dk)
2165, Finland (fi)
2174, France (fr)
2109, Germany (de)
2200, Greece (gr)
2219, Hong Kong (hk)
2248, India (in)
2238, Indonesia (id)
2239, Ireland (ie)
2254, Italy (it)
2276, Japan (jp)
2304, Korea (kr)
2333, Luxembourg (lu)
2363, Malaysia (my)
2362, Mexico (mx)
2376, Netherlands (nl)
2390, New Zealand (nz)
2379, Norway (no)
2427, Pakistan (pk)
2424, Philippines (ph)
2428, Poland (pl)
2436, Portugal (pt)
2489, Russia (ru)
2501, Singapore (sg)
2149, Spain (es)
2499, Sweden (se)
2086, Switzerland (ch)
2543, Taiwan (tw)
2528, Thailand (th)
2184, United Kingdom (gb)

Index

Words in quotations appear in the on-screen displays.

A

AC adapter 12
AUDIO 7
“Audio Settings” 19

B

Batteries 9
BRAVIA Internet Video 14
BRAVIA Sync 25, 27

C

CLEAR 7
Color buttons 7
Connecting
 AV amplifier
 (Receiver) 11
 Network 13
 TV 10
“Control for HDMI” 21, 25, 27

D

Deep Color 19
DISPLAY 7
DLNA 15
Dolby Digital 19
DTS 19

E

“Easy Setup” 12, 22

F

FAVORITES 7

H

HDMI 18, 19
HOME 7, 17
Home menu 17

I

Internet content 7, 14
“IP Content Noise Reduction” 16

L

Language Follow 27

M

MAC address 21
MUTING 7

N

“Network Settings” 21
“Network Update” 18

O

One-Touch Play 27
OPTIONS 7
“OSD” 21

P

Parental Control 20
“Parental Control Settings” 20
Playable files 26

R

Remote 7, 9
“Resetting” 22
Resetting the player 22
Resume 8, 25

S

“Screen Settings” 18
“Setup” 17
Software update 18, 21
SUBTITLE 7
System Power-Off 27
“System Settings” 21

T

THEATER 8, 27
Troubleshooting 23
“TV Type” 18

U

Update 18
USB 15

W

WEP 28
WIDE 7
WPA2-PSK (AES) 28
WPA2-PSK (TKIP) 28
WPA-PSK (AES) 28
WPA-PSK (TKIP) 28

