

SONY®

3-214-661-12(1)

Digital HD Video Camera Recorder

HANDYCAM®

Operating Guide

HDR-CX6EK/CX7E/CX7EK

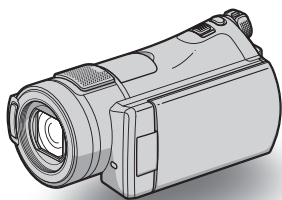

AVCHD



HDMI

For details on the advanced operations, please refer to
“Handycam Handbook” (PDF).



Read this first

Before operating the unit, please read this manual thoroughly, and retain it for future reference.

WARNING



To reduce fire or shock hazard, do not expose the unit to rain or moisture.

CAUTION

Replace the battery with the specified type only. Otherwise, fire or injury may result.

Notice for customers in the United Kingdom

A moulded plug complying with BS 1363 is fitted to this equipment for your safety and convenience.

Should the fuse in the plug supplied need to be replaced, a fuse of the same rating as the supplied one and approved by ASTA or BSI to BS 1362 (i.e., marked with an  or  mark) must be used.

If the plug supplied with this equipment has a detachable fuse cover, be sure to attach the fuse cover after you change the fuse. Never use the plug without the fuse cover. If you should lose the fuse cover, please contact your nearest Sony service station.

FOR CUSTOMERS IN EUROPE

ATTENTION

The electromagnetic fields at the specific frequencies may influence the picture and sound of this unit.

This product has been tested and found compliant with the limits set out in the EMC Directive for using connection cables shorter than 3 meters (9.8 feet).

Notice

If static electricity or electromagnetism causes data transfer to discontinue midway (fail), restart the application or disconnect and connect the communication cable (USB, etc.) again.



Disposal of Old Electrical & Electronic Equipment (Applicable in the European Union and other European countries with separate collection systems)

This symbol on the product or on its packaging indicates that this product shall not be treated as household waste. Instead it shall be handed over to the applicable collection point for the recycling of electrical and electronic equipment.

By ensuring this product is disposed of correctly, you will help prevent potential negative consequences for the environment and human health, which could otherwise be caused by inappropriate waste handling of this product. The recycling of materials will help to conserve natural resources. For more detailed information about recycling of this product, please contact your local Civic Office, your household waste disposal service or the shop where you purchased the product.

Applicable Accessory: Remote Commander

HDR-CX6EK/CX7EK: "Memory Stick PRO Duo"

"Memory Stick"



Notes on use

Types of "Memory Stick" you can use with your camcorder

- For recording movies, it is recommended that you use a “Memory Stick PRO Duo” of 512 MB or larger marked with:
 - **MEMORY STICK PRO DUO** (“Memory Stick PRO Duo”)
 - **MEMORY STICK PRO-HG DUO** (“Memory Stick PRO-HG Duo”)
- A “Memory Stick PRO Duo” of up to 8 GB has been confirmed to operate correctly with this camcorder.
- See page 12 for the recordable time of a “Memory Stick PRO Duo.”
- “Memory Stick PRO Duo” and “Memory Stick PRO-HG Duo” are both called as “Memory Stick PRO Duo” in this manual.

Using the camcorder

- The camcorder is not dustproofed, dripproofed or waterproofed. See “Precautions” (p. 32).
- To prevent the “Memory Stick PRO Duo” from being broken or recorded images from being lost, do not do the following when either of the respective lamps of the POWER switch (p. 9) or the access lamp (p. 10) is on:
 - to remove the battery pack or AC Adaptor from the camcorder.
 - to apply mechanical shock or vibration to the camcorder.
- When inserting or ejecting the “Memory Stick PRO Duo,” be careful so that the “Memory Stick PRO Duo” does not pop out and drop (p. 10).
- When connecting your camcorder to another device with a cable, be sure to insert the connector plug in the correct way. Pushing the plug forcibly into the terminal will damage the terminal and may result in a malfunction of your camcorder.

On recording

- Before starting to record, test the recording function to make sure the image and sound are recorded without any problems.
- Compensation for the contents of recordings cannot be provided, even if recording or playback is not possible due to a malfunction of the camcorder, recording media, etc.
- TV color systems differ depending on the country/region. To view your recordings on a TV, you need a PAL system-based TV.

- Television programs, films, video tapes, and other materials may be copyrighted. Unauthorized recording of such materials may be contrary to the copyright laws.

On playing back recorded images on other devices

- To view the HD (high definition) images recorded on the “Memory Stick PRO Duo” on other devices, the device must comply with the AVCHD format. Otherwise, you cannot view the images.

Save all your recorded image data

- To prevent your image data from being lost, save all your recorded images on other media. It is recommended that you save the image data on a disc such as DVD-R using your computer. Also, you can save your image data using a VCR, or a DVD/HDD recorder (p. 23).
- It is recommended that you save your image data periodically, after recording.

When the camcorder is connected to a computer

- Do not try to format the “Memory Stick PRO Duo” in the camcorder using a computer. If you do so, your camcorder may not operate correctly.

About language setting

- The on-screen displays in each local language are used for illustrating the operating procedures. Change the screen language before using your camcorder if necessary (p. 9).

About this manual

- The images of the LCD screen used in this manual for illustration purposes are captured using a digital still camera, and therefore may appear different from the actual images of the LCD screen.
- Design and specifications of recording media and other accessories are subject to change without notice.
- The screenshots are from Windows XP. The scenes may vary depending on the operating system of the computer.

Table of Contents

Read this first	2
Notes on use	2

Getting Started

Step 1: Checking supplied items	5
Step 2: Charging the battery pack	6
Step 3: Turning the power on, and setting the date and time	9
Changing the language setting	9
Step 4: Inserting a "Memory Stick PRO Duo"	10

Recording/Playback

Recording	11
Playback	13
Playing the image on a TV	14
Names and functions of parts and controls	15
Indicators displayed during recording/playback	18
Performing various functions - "HOME" and "OPTION"	20
Saving images	23
Deleting images	23

Enjoying with a computer

Viewing "Handycam Handbook" (PDF)	24
What you can do with a Windows computer	25

Troubleshooting

Troubleshooting	29
-----------------------	----

Additional Information

Precautions	32
Specifications	34

Step 1: Checking supplied items

Make sure that you have the following items supplied with your camcorder. The number in the parentheses indicates the number of that item supplied.

AC Adaptor (1) (p. 6)

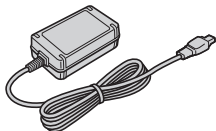

Mains lead (1) (p. 6)



Handycam Station (1) (p. 6)

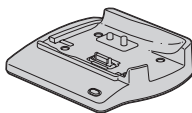

Component video cable (1) (p. 14)

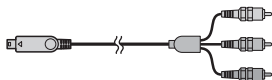

A/V connecting cable (1) (p. 14)



USB cable (1) (p. 26)

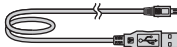

Wireless Remote Commander (1)



A button-type lithium battery is already installed.

Remove the insulation sheet before using the Remote Commander.

Insulation sheet

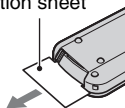

Rechargeable battery pack (1) (p. 6)
NP-FH60

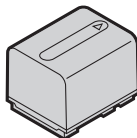

21-pin adaptor (1)

For the models with the  mark printed on their bottom surfaces only.

CD-ROM "Handycam Application Software" (1) (p. 24)

- Picture Motion Browser (Software)
- Picture Motion Browser Guide
- Handycam Handbook (PDF)

"Operating Guide" (This manual) (1)

HDR-CX6EK/CX7EK

"Memory Stick PRO Duo" 4 GB (1) (p. 10)

Step 2: Charging the battery pack

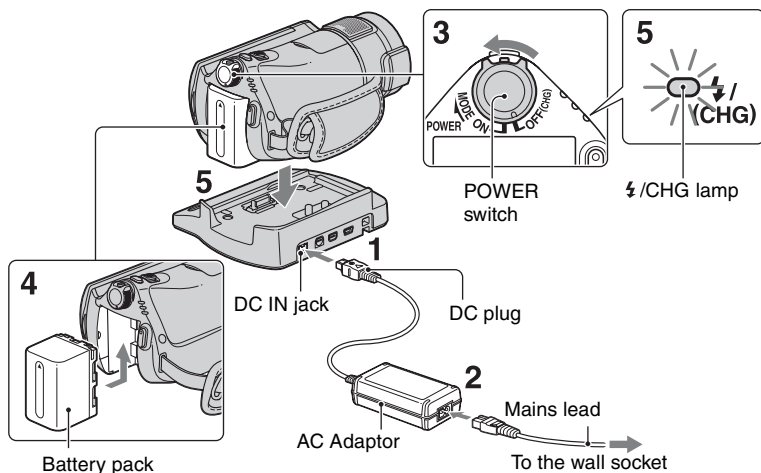

You can charge the “InfoLITHIUM” battery pack (H series) after attaching it to your camcorder.

⚡ Notes

- Your camcorder operates only with an “InfoLITHIUM” battery pack (H series).

1 Connect the AC Adaptor to the DC IN jack on the Handycam Station.

Be sure that the ▲ mark on the DC plug is facing up.

2 Connect the mains lead to the AC Adaptor and the wall socket.

3 Slide the POWER switch in the direction of the arrow to OFF (CHG) (the default setting).

4 Attach the battery pack by sliding it in the direction of the arrow until it clicks.

5 Place the camcorder on the Handycam Station as shown above, and insert it into the Handycam Station securely, all the way to the bottom.

The ⚡/CHG (charge) lamp lights up and charging starts. The ⚡/CHG (charge) lamp turns off when the battery pack is fully charged. Remove the camcorder from the Handycam Station.



To remove the battery pack

Slide the POWER switch to OFF (CHG). Slide the BATT (battery release) lever and remove the battery pack.

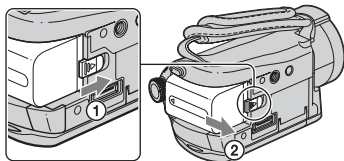
BATT (battery release) lever



Notes

- When you remove the battery pack or the AC Adaptor, make sure that the  (Movie) lamp/  (Still) lamp (p. 9) is turned off.

To charge the battery pack using only the AC Adaptor

Slide the POWER switch to OFF (CHG), then connect the AC Adaptor directly to the DC IN jack on the camcorder.

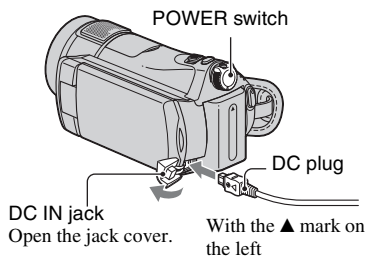

Available running time for the supplied battery pack

Charging time:

Approximate time (min.) required when you fully charge a completely exhausted battery pack.

Recording/Playback time:

Approximate time (min.) available when you use a fully charged battery pack.

“HD” stands for high definition image quality, and “SD” stands for standard image quality.

	(Unit:min.)	
	HD	SD
Charging time	135	
Recording time*1		
Continuous recording time	95	110
Typical recording time*2	45	55
Playback time*3	160	190



*1 All times are measured under following conditions.

- Recording mode: SP
- [ INDEX]: [OFF]
- LCD backlight: [ON] (top), [OFF] (bottom)

*2 Typical recording time shows the time when you repeat recording start/stop, turning the power on/off and zooming.

*3 When the LCD backlight is on.

On the battery pack

- Before changing the battery pack, slide the POWER switch to OFF (CHG) and turn off the  (Movie) lamp/  (Still) lamp (p. 9).
- The power will not be supplied from the battery as long as the AC Adaptor is connected to the DC IN jack of your camcorder or the Handycam Station, even when the mains lead is disconnected from the wall socket.

On the charging/recording/playback time

- Times measured when using the camcorder at 25°C (77°F) (10°C to 30°C (50°F to 86°F) is recommended).
- The available recording and playback time will be shorter when you use your camcorder in low temperatures.
- The available recording and playback time will be shorter depending on the conditions under which you use your camcorder.

On the AC Adaptor

- Use the nearby wall socket when using the AC Adaptor. Disconnect the AC Adaptor from the

wall socket immediately if any malfunction occurs while using your camcorder.

- Do not use the AC Adaptor placed in a narrow space, such as between a wall and furniture.
- Do not short-circuit the DC plug of the AC Adaptor or battery terminal with any metallic objects. This may cause a malfunction.
- Even if your camcorder is turned off, AC power (mains) is still supplied to it while connected to the wall socket via the AC Adaptor.

Step 3: Turning the power on, and setting the date and time

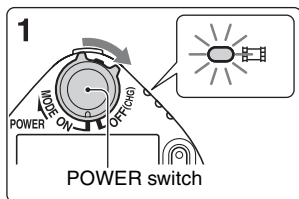

Touch the button on the LCD screen.

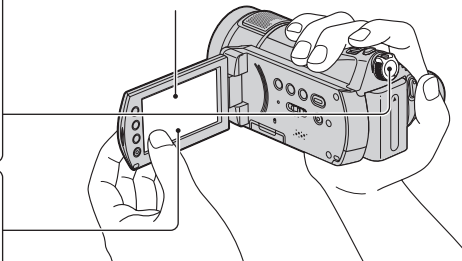

When using the camcorder for the first time, the [CLOCK SET] screen appears on the LCD screen.



- 1 While pressing the green button, slide the **POWER** switch repeatedly in the direction of the arrow until the respective lamp lights up.

(Movie): To record movies

(Still): To record still images

- When you turn on (Still) lamp, the screen aspect ratio is changed to 4:3 automatically.

- 2 Select the desired geographical area with **▲/▼**, then touch **[NEXT]**.

- 3 Set **[SUMMERTIME]**, **[Y]** (year), **[M]** (month), **[D]** (day), hour and minute.



The clock starts.

Tips

- The date and time do not appear during recording, but they are automatically recorded on the “Memory Stick PRO Duo,” and can be displayed during playback.
- You can turn off the operation beeps by touching (HOME) → (SETTINGS) → [SOUND/DISP SET] → [BEEP] → [OFF].

To reset the date and time

Touch (HOME) → (SETTINGS) → [CLOCK/] LANG] → [CLOCK SET], and set the date and time.

Changing the language setting

You can change the on-screen displays to show messages in a specified language. Touch (HOME) → (SETTINGS) → [CLOCK/] LANG] → [] LANGUAGE SET], then select the desired language.

Step 4: Inserting a “Memory Stick PRO Duo”

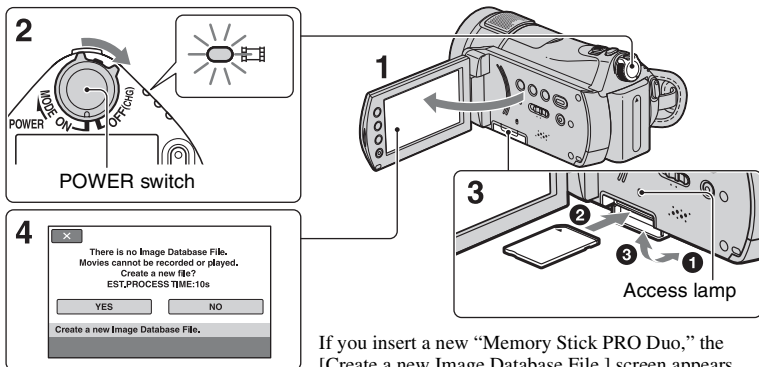

See page 2 on the “Memory Stick” you can use with your camcorder.

1 Open the LCD panel.

2 Slide the POWER switch repeatedly until the (Movie) lamp lights up.

3 Insert the “Memory Stick PRO Duo.”

- 1 Open the Memory Stick Duo cover in the direction of the arrow.
- 2 Insert the “Memory Stick PRO Duo” into the Memory Stick Duo slot in the right direction until it clicks.
- 3 Close the Memory Stick Duo cover.

4 On the [Create a new Image Database File.] screen, touch [YES].

To eject a “Memory Stick PRO Duo”

Open the LCD panel and Memory Stick Duo cover, lightly push the “Memory Stick PRO Duo” in once.

Notes

- When the access lamp is lit or flashing, your camcorder is reading/writing data. To prevent image data from being damaged, do not:
 - eject the “Memory Stick PRO Duo”
 - remove the battery pack or AC Adaptor
 - shake or knock your camcorder
- Do not open the Memory Stick Duo cover during recording.
- If you force the “Memory Stick PRO Duo” into the slot in the wrong direction, the “Memory Stick PRO Duo,” the Memory Stick Duo slot, or image data may be damaged.
- If [Failed to create a new Image Database File. It may be possible that there is not enough free space.] is displayed on step 4, format the “Memory Stick PRO Duo” (p. 23). Note that formatting will delete all data recorded on the “Memory Stick PRO Duo.”

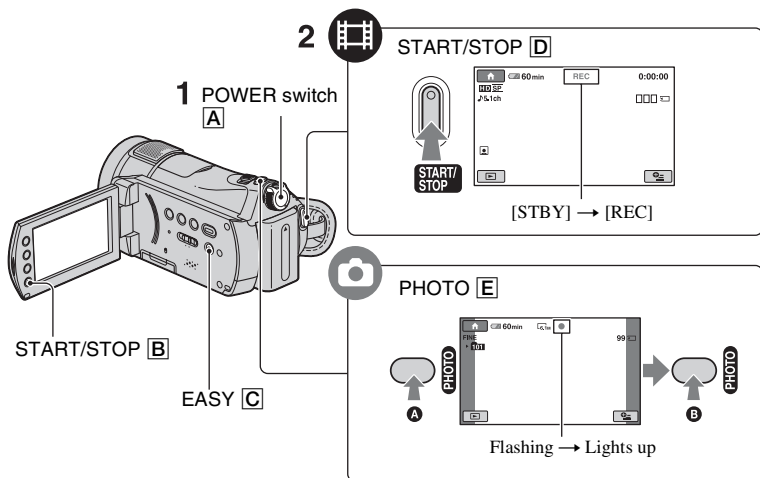

1 Slide the POWER switch **A** until the respective lamp lights up.

Press the green button only when the POWER switch is in the OFF (CHG) position.

- (Movie): To record movies
- (Still): To record still images

2 Start recording.

Movies

Press **START/STOP** **D** (or **B**).

To stop recording, press **START/STOP** again.

- See “Handycam Handbook” (PDF) to display the image of SD (standard definition) image quality.

Still Images

Press **PHOTO** **E** lightly to adjust the focus **A** (a beep sounds), then press it fully **B** (a shutter click sounds).

appears beside . When disappears, the image has been recorded.

💡 Tips

- You can check the free “Memory Stick PRO Duo” space by touching **HOME** → **MANAGE MEMORY STICK** → [INFO].
- You can capture up to 3 still images by pressing **PHOTO** during movie recording.
- The maximum recordable time of Sony “Memory Stick PRO Duo” is as follows with recording mode [HD SP] (the default setting);
512 MB: approx. 8 minutes
1 GB: approx. 15 minutes
2 GB: approx. 35 minutes
4 GB: approx. 65 minutes
8 GB: approx. 140 minutes
- When measuring “Memory Stick PRO Duo” capacity, 1 GB equals 1 billion bytes, a portion of which is used for data management.
- See “Handycam Handbook” (PDF) for the number of recordable still images.
- You can copy scenes of recorded movies as still images on the hard disk of a computer, using the supplied “Picture Motion Browser.” For details, see “Picture Motion Browser Guide” on the supplied CD-ROM.

To record/play back easily

By pressing **EASY**, nearly all settings on the camcorder will be set to automatic adjustment so that you can perform recording or playback operation without detailed settings. During Easy Handycam operation, **EASY** appears on the LCD screen. To cancel Easy Handycam operation, press **EASY** again.

🔊 Notes

- You cannot use some buttons/functions during Easy Handycam operation.

Adjusting the LCD panel

Open the LCD panel 90 degrees to the camcorder (①), then rotate it to the best angle to record or play (②).

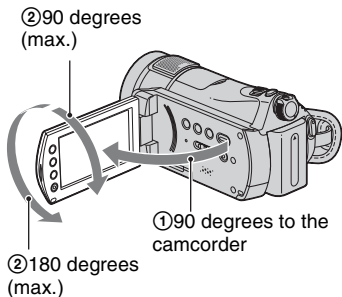

Fastening the grip belt

Fasten the grip belt and hold your camcorder correctly.

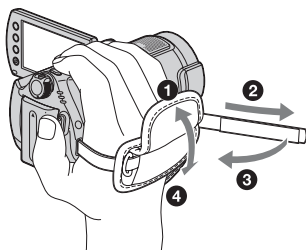

Playback

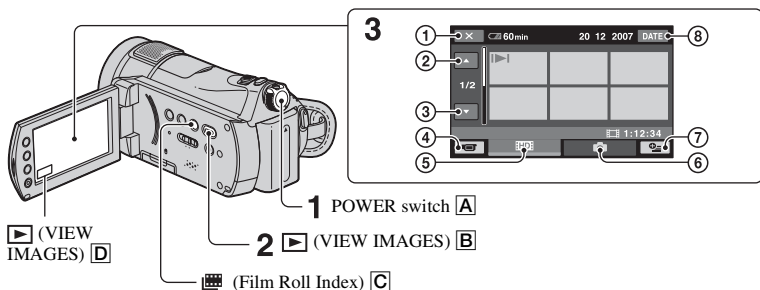

① Returns to the recording screen

② Previous 6 images

③ Next 6 images

④ Returns to the recording screen

⑤ HD (high definition) image quality movie tab*

⑥ Still image tab

⑦ $\left[\begin{array}{c} \oplus \\ \ominus \end{array} \right]$ (OPTION)

⑧ Searches for images by date

* $\left[\begin{array}{c} \text{HSD} \\ \text{SD} \end{array} \right]$ appears for movies with SD (standard definition) image quality.

1 Slide the POWER switch $\left[\begin{array}{c} \text{A} \end{array} \right]$ to turn on your camcorder.

2 Press the $\left[\begin{array}{c} \text{VIEW IMAGES} \\ \text{B} \end{array} \right]$ (or $\left[\begin{array}{c} \text{VIEW IMAGES} \\ \text{D} \end{array} \right]$) button.

The VISUAL INDEX screen appears on the LCD screen (It may take some time to display the thumbnails).

- Press the $\left[\begin{array}{c} \text{INDEX} \\ \text{C} \end{array} \right]$ (Film Roll Index) button $\left[\begin{array}{c} \text{INDEX} \\ \text{C} \end{array} \right]$ to play back images from $\left[\begin{array}{c} \text{INDEX} \\ \text{C} \end{array} \right]$ INDEX. See “Handycam Handbook” (PDF) for details.

3 Start playback.

Movies



Touch the $\left[\begin{array}{c} \text{HSD} \\ \text{SD} \end{array} \right]$ or $\left[\begin{array}{c} \text{HSD} \\ \text{SD} \end{array} \right]$ tab, and the movie to be played back.

Beginning of the scene/previous scene

Toggles Play or Pause as you touch

Next scene

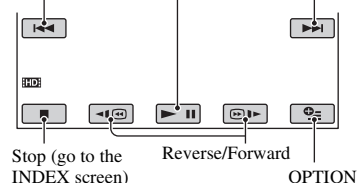





Still Images

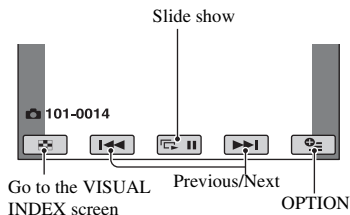



Touch the $\left[\begin{array}{c} \text{Still Image} \end{array} \right]$ tab, and the still image to be played back.



To adjust the sound volume of movies

When playing back a movie, touch  (OPTION) →  tab → [VOLUME], then adjust the volume with  / .

Tips

- When playback from the selected movie reaches the last movie, the screen returns to the INDEX screen.
-  appears with the image on the tab that was most recently played back/recorded ( for the still image). When you touch a movie marked with , you can play it back from the point it was previously stopped.

Playing the image on a TV

Connection methods and quality of the image viewed on the TV screen differ depending on what type of TV is connected, and the connectors used.

Notes



- When recording, set [X.V.COLOR] to [ON] to play back on an x.v.Color-compliant TV. Some settings may need to be adjusted on the TV when playing back. Refer to the instruction manual of your TV for details.
- Use the supplied AC Adaptor as the power source (p. 6). Refer also to the instruction manuals supplied with the device to be connected.

Operation flow

Switch the input on the TV to the connected jack.

Refer to the instruction manuals of the TV.

↓
Connect your camcorder and TV referring to [TV CONNECT Guide].

Touch  (HOME) →  (OTHERS) → [TV CONNECT Guide].

↓
Make the required output settings on your camcorder.

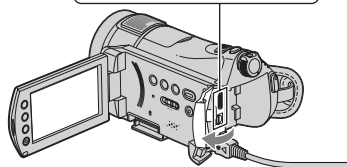
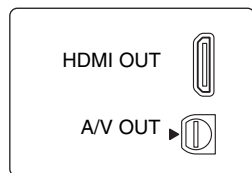

Open the jack cover.

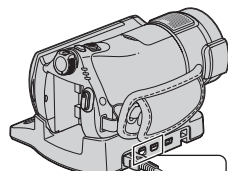

Handycam Station

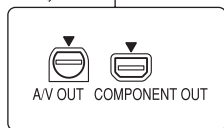

Notes

- Only the Handycam Station is equipped with the COMPONENT OUT jack.
- When the A/V connecting cable is used to output images, images are output with SD (standard definition) image quality.
- The Handycam Station and your camcorder are both equipped with A/V OUT jacks. Connect the A/V connecting cable either to the Handycam Station or to your camcorder, depending on your setup. Do not connect A/V connecting cables to both the Handycam Station and your camcorder at the same time, as image disturbance may occur.
- For details on connecting and dubbing recorded images to VCR or DVD/HDD recorders, see “Handycam Handbook” (PDF).

Names and functions of parts and controls

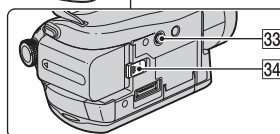
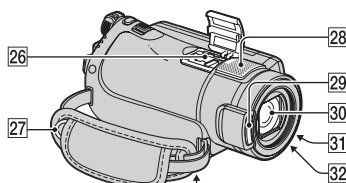
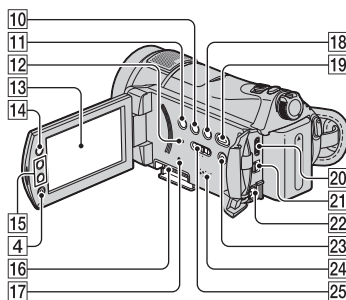
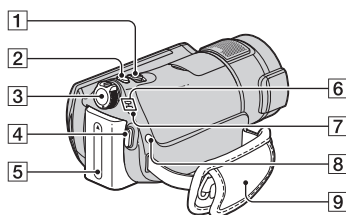

Handycam Station

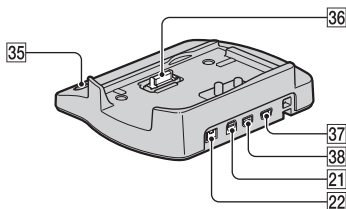

1 Power zoom lever

To use the zoom, move the power zoom lever. Move the power zoom lever slightly for a slower zoom. Move it further for a faster zoom.

During playback, you can magnify still images from about 1.1 to 5 times the original size (Playback zoom).

- When you touch the screen during playback zoom, the point you touched will be displayed in the center of the displayed frame.

2 PHOTO button (p. 11)

3 POWER switch (p. 9, 11)

4 START/STOP button (p. 11)

5 Battery pack (p. 6)

6 (Movie)/ (Still) mode lamps (p. 11)

7 ζ /CHG (charge) lamp

Lights up while charging your camcorder, or flickers while charging the flash, and remains lit when the flash charging is complete.

8 ζ (flash) button

You can select the settings for the flash.

9 Grip belt (p. 12)

10 DISP/BATT INFO button

You can switch the screen display when you press while the power is set to on. When you press while the power is set to OFF (CHG), you can check the remaining battery.

11 BACK LIGHT button

To adjust the exposure for backlit subjects, press BACK LIGHT to display \square . To cancel the backlight function, press BACK LIGHT again.

12 RESET button

To initialize the settings (Reset), press RESET to initialize all the settings, including settings for date and time.

13 LCD screen/touch panel

To record in mirror mode, open the LCD screen 90 degrees to the camcorder (①), then rotate it 180 degrees to the lens side (②).

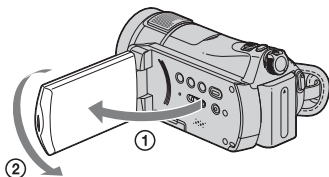

14 (HOME) button (p. 20)

15 Zoom buttons

Press for zooming in/out.

During playback, you can magnify still images from about 1.1 to 5 times the original size (Playback zoom).

- When you touch the screen during playback zoom, the point you touched will be displayed in the center of the displayed frame.

16 Memory Stick Duo slot (p. 10)

17 Access lamp

When the access lamp is lit or flashing, your camcorder is writing or reading data on the “Memory Stick PRO Duo.”

18 (Film Roll Index) button (p. 13)

19 (VIEW IMAGES) button (p. 13)

23 EASY button (p. 12)

24 Speaker

Sound comes out from the speaker while playing back.

25 NIGHTSHOT switch

To record in dark places, set the NIGHTSHOT switch to ON ( appears).

27 Hook for a shoulder belt

Attach the shoulder belt (optional).

28 Internal microphone

Records sound on movies.

Sound picked up by the internal microphone is converted to 5.1ch surround sound and recorded.

29 Flash

Flashes when using the flash.

30 Lens (Carl Zeiss Lens)

31 Camera recording lamp

Lights up in red during recording. Flashes when remaining “Memory Stick PRO Duo” space or battery power is low.

32 Remote sensor/Infrared port

Receive the signal from the Remote Commander.

33 Tripod receptacle (Bottom surface)

Attach the tripod (optional: the length of the screw must be less than 5.5 mm (7/32 in.)) to the tripod receptacle using a tripod screw.

34 BATT (battery release) lever (p. 7)

Connecting to other devices

20 HDMI OUT (mini) jack

Connect an HDMI cable (optional).

21 A/V OUT jack

Connect the A/V connecting cable.

22 DC IN jack

26 Active Interface Shoe Active Interface Shoe

The Active Interface Shoe supplies power to optional accessories such as a video light, a flash, or a microphone. The accessory can be turned on or off as you operate the POWER switch on your camcorder.

35 DISC BURN button

Create a disc by connecting the camcorder to a computer. For details, see “Picture Motion Browser Guide.”

36 Interface connector

37 (USB) jack

Connect the USB cable.

38 COMPONENT OUT jack

Connect the component video cable.

Indicators displayed during recording/playback

Recording movies

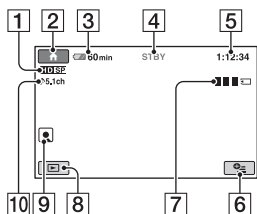

Recording still images

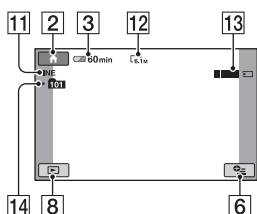

Viewing movies

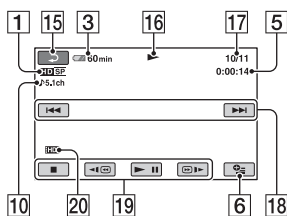

Viewing still images

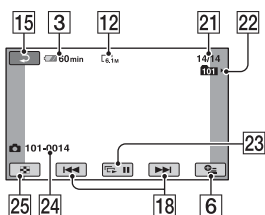

- 1 Recording quality (HD/SD) and Recording mode (XP/HQ/SP/LP)
- 2 HOME button
- 3 Remaining battery (approx.)
- 4 Recording status ([STBY] (standby) or [REC] (recording))
- 5 Counter (hour/minute/second)
- 6 OPTION button
- 7 Dual Rec
- 8 VIEW IMAGES button
- 9 Face Index Set
- 10 5.1ch surround recording
- 11 Quality ([FINE]/[STD])
- 12 Image size
- 13 This appears while a still image is being saved.
- 14 Recording folder
- 15 Return button
- 16 Playback mode
- 17 Currently playing movie number/ Number of total recorded movies
- 18 Previous/Next button
- 19 Video operation buttons
- 20 Playing back image quality
- 21 Current still image number/Number of total recorded still images
- 22 Playback folder
- 23 Slide show button
- 24 Data file name
- 25 VISUAL INDEX button

💡 Tips

- As the number of still images recorded on a "Memory Stick PRO Duo" increases, new folders are automatically created to store still images.

Indicators on the LCD screens

Following indicators appear during recording/playback to indicate the settings of your camcorder.

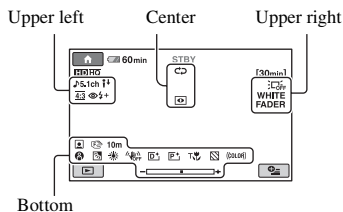

Upper left

Indicator	Meaning
	5.1ch surround recording/playback
	Self-timer recording
	Flash, REDEYE REDUC
	MICREF LEVEL low
	WIDE SELECT

Center

Indicator	Meaning
	Continuous slide show
	NightShot
	Super NightShot
	Color Slow Shutter
	PictBridge connecting
	Warning

Upper right

Indicator	Meaning
	FADER
	LCD backlight off

Bottom

Indicator	Meaning
	Picture effect
	Digital effect
	Manual focus
	SCENE SELECTION
	Backlight
	White balance
	SteadyShot off
	EXPOSURE/ SPOT METER
	TELE MACRO
	ZEBRA
	X.V.COLOR
	Face Index set

Notes

- The recording date and time are recorded automatically on the "Memory Stick PRO Duo." They are not displayed while recording. However, you can check them as [DATA CODE] during playback.

Performing various functions - “ HOME” and “ OPTION”

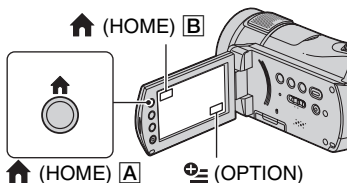

Using the HOME MENU

You can change the recording functions and the operating settings for your convenience. For details, see “Handycam Handbook” (PDF).

- 1 Turn on your camcorder, then press  (HOME) **A** (or **B**).





Category

- 2 Touch the desired category.

- 3 Touch the desired setup item.



- 4 Follow the guide on the screen for further operation.

Tips

- If the item is not on the screen, touch / to change the page.
- To hide the HOME MENU screen, touch .

- You cannot simultaneously select or activate the grayed items in the current recording/playback situation.

To see the explanation of the function of each item on the HOME MENU (HELP)

- ① Press  (HOME) **A** (or **B**).
- ② Touch  (HELP).

The bottom of the  (HELP) turns orange.



- ③ Touch the item you want to learn about. When you touch an item, its explanation appears on the screen. To apply the option, touch [YES].

Using the OPTION MENU

The  OPTION MENU appears just like the pop-up window that appears when you right-click the mouse on a computer. Various functions are displayed in the context of the operation. For details, see “Handycam Handbook” (PDF).

- 1 While using your camcorder, touch  (OPTION) on the screen.

- 2 Touch the desired item.

- 3 Change the setting, then touch .

Notes

- When the item you want is not on the screen, touch another tab.
- The tabs and items that appear on the screen depend on the recording/playback status of your camcorder at the time.
- Some items appear without a tab.
- The  OPTION MENU cannot be used during Easy Handycam operation (p. 12).

Items of the HOME MENU









(CAMERA) category

MOVIE*¹
PHOTO*¹
SMTH SLW REC











(VIEW IMAGES) category

VISUAL INDEX*¹
 INDEX*¹
 INDEX*¹
PLAYLIST

(OTHERS) category

DELETE*¹
[]DELETE], []DELETE],
[]DELETE], []DELETE ALL],
[]DELETE ALL], []DELETE
ALL], []DELETE by date],
[]DELETE by date]

EDIT
[DELETE], [DIVIDE]

PLAYLIST EDIT
[]ADD], []ADD], []
ADD by date], []ADD by date],
[]ERASE], []ERASE], []
ERASE ALL], []ERASE ALL],
[]MOVE], []MOVE]



PRINT

COMPUTER

[] COMPUTER], [DISC BURN]

TV CONNECT Guide*¹

(MANAGE MEMORY STICK) category

 FORMAT*¹
 INFO
REPAIR IMG.DB F.

(SETTINGS) category

MOVIE SETTINGS









[]/[] REC SET]*¹, [] REC
MODE], [] REC MODE],
[NIGHTSHOT LIGHT], [WIDE
SELECT], [DIGITAL ZOOM],
[STEADYSHOT], [AUTO SLW
SHUTTR], [X.V.COLOR],
[GUIDEFAME], [ZEBRA], []
REMAINING], [FLASH LEVEL],
[REDEYE REDUC], [] INDEX
SET]*¹

PHOTO SETTINGS

[] IMAGE SIZE]*¹, []
QUALITY], [FILE NO.],
[NIGHTSHOT LIGHT],
[STEADYSHOT], [GUIDEFAME],
[ZEBRA], [FLASH LEVEL],
[REDEYE REDUC]

VIEW IMAGES SET

[]/[] INDEX SET]*¹, [DATA
CODE], [] DISPLAY], []
INTERVAL SET]*¹

SOUND/DISP SET*²

[VOLUME]*¹, [BEEP]*¹, [LCD
BRIGHT], [LCD BL LEVEL], [LCD
COLOR]

OUTPUT SETTINGS

[TV TYPE], [DISP OUTPUT],
[COMPONENT]

CLOCK/ LANG

[CLOCK SET]*¹, [AREA SET],
[SUMMERTIME], []
LANGUAGE SET]*¹

GENERAL SET

[DEMO MODE], [REC LAMP],
[CALIBRATION], [A.SHUT OFF],
[REMOTE CTRL]

*¹ You can set these items also during Easy Handycam operation (p. 12).

*² The menu name is changed to [SOUND SETTINGS] during Easy Handycam operation (p. 12).

Items of the OPTION MENU

Items you can set only on the OPTION MENU will be described below.

tab

[FOCUS], [SPOT FOCUS], [TELE MACRO], [EXPOSURE], [SPOT METER], [SCENE SELECTION], [WHITE BAL.], [COLOR SLOW SHTR], [SUPER NIGHTSHOT]

tab

[FADER], [D.EFFECT], [PICT.EFFECT]

tab

[MICREF LEVEL], [SELF-TIMER], [TIMING], [RECORD SOUND]

– (The tab depends on the situation/No tab)

[SLIDE SHOW], [SLIDE SHOW SET], [COPIES], [DATE/TIME], [SIZE]

Saving images

Due to the limited capacity of the “Memory Stick PRO Duo,” make sure that you save the image data to some type of media such as a DVD-R or the hard disk of a computer. You can save the images recorded on the camcorder as described below.

Saving images using a computer

By using the “Picture Motion Browser” on the supplied CD-ROM, you can save images on a disc or the hard disk of a computer. For details, see “Picture Motion Browser Guide.”

Creating a disc with One Touch (One Touch Disc Burn)

You can save images recorded on the camcorder directly to a disc with ease.

Saving images on a computer (Easy PC Back-up)

You can save images recorded on the camcorder on the hard disk of a computer.



Creating a disc with selected images



You can save images imported to your computer on a disc. You can also edit those images.

Saving images by connecting your camcorder to other devices

You can dub images to VCR or DVD/HDD devices. For details, see “Handycam Handbook” (PDF).

Deleting images

1 On the  (HOME MENU), touch  (OTHERS) → [DELETE].

2 Touch [ DELETE] or [ DELETE] (movies), or [ DELETE] (still images), according to the type of image you want to delete.

3 Touch the image to be deleted.



The selected image is marked with .

4 Touch [OK] → [YES] → [OK].

To delete all movies or still images at one time

In step **2**, touch [ DELETE ALL]/[ DELETE ALL]/[ DELETE ALL] → [YES] → [YES] → [OK].

To delete all images (Format)

Touch  (HOME) →  (MANAGE MEMORY STICK) → [ FORMAT] → [YES] → [YES] → [OK].

Notes

- Note that formatting will delete all data recorded on the “Memory Stick PRO Duo.”

Viewing “Handycam Handbook” (PDF)

For advanced use of your camcorder, see “Handycam Handbook” (PDF). To view “Handycam Handbook” (PDF), you need to install Adobe Reader on your computer.

For Windows users

1 Turn on the computer.

2 Place the CD-ROM (supplied) in the disc drive of your computer.

The select screen for installation appears.



3 Click [Handycam Handbook].

The installation screen for “Handycam Handbook” (PDF) appears.

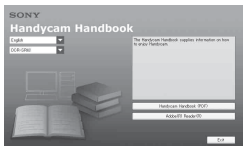

4 Select the desired language and the model name of your Handycam, then click [Handycam Handbook (PDF)].

Installation starts. When the installation is completed, the short-cut icon of “Handycam Handbook” appears on the desktop of your computer.

- The model name of your Handycam is printed on its bottom surface.

5 Click [Exit] → [Exit], then remove the CD-ROM from the disc drive of your computer.

For Macintosh users

1 Turn on the computer.

2 Place the CD-ROM (supplied) in the disc drive of your computer.

3 Open the [Handbook] folder in the CD-ROM, double-click the [GB] folder and then drag-and-drop the “Handbook.pdf” on the computer.

Double-click “Handbook.pdf” to view the handbook.

What you can do with a Windows computer

When you install the “Picture Motion Browser” on a Windows computer from the supplied CD-ROM, you can enjoy the following operations.

■ Creating a disc with images taken with your camcorder by one simple operation

By pressing DISC BURN (p. 17) on the Handycam Station, you can save images recorded on your camcorder to a disc on your computer.

■ Importing images taken with your camcorder to a computer

■ Viewing imported images on a computer

■ Creating a disc with edited images

For details on the functions of “Picture Motion Browser,” see “Picture Motion Browser Guide” (p. 27).

🔍 Notes

- This camcorder captures high definition footage in the AVCHD format. Using the enclosed PC software, high definition footage can be copied onto DVD media. However, DVD media containing AVCHD footage should not be used with DVD based players or recorders, as the DVD player/recorder may fail to eject the media and may erase its contents without warning. DVD media containing AVCHD footage may be played on a compatible Blu-ray Disc™ player/recorder or other compatible device.

■ Using a Macintosh computer

The supplied software “Picture Motion Browser” does not support a Macintosh computer.

On the advanced use of images on your camcorder connected to your computer, see the following URL;
<http://guide.d-imaging.sony.co.jp/mac/ms/us/>

Installing the software

■ Environment for using “Picture Motion Browser”

OS: Microsoft Windows 2000 Professional SP4/Windows XP SP2*/Windows Vista*

* 64-bit editions and Starter (Edition) are not supported.

- Standard installation is required.
- Operation is not assured if the above OS has been upgraded or in a multi-boot environment.

CPU: Intel Pentium 4 2.8 GHz or faster (Intel Pentium 4 3.6 GHz or faster, Intel Pentium D 2.8 GHz or faster, Intel Core Duo 1.66 GHz or faster, Intel Core 2 Duo 1.66 GHz or faster is recommended.)

- The following operations are possible with Intel Pentium III 1 GHz or faster.
 - Importing the contents to the computer
 - One Touch Disc Burn
 - Creating an AVCHD format disc/DVD video
 - Copying a disc
 - Processing only the contents in SD (standard definition) image quality

Memory:

Windows 2000, Windows XP: 512 MB or more (1 GB or more is recommended.)

For processing SD (standard definition) image quality content only, 256 MB of memory or more is necessary.

Windows Vista: 1 GB or more

Hard disk: Disk volume required for installation: Approximately 800 MB (10 GB or more may be necessary when creating AVCHD format discs.)

Display: DirectX 7 or later-compatible video card, Minimum 1,024 × 768 dots, High Color (16 bit color)

Others: ♪ USB port (this must be provided as standard), Hi-Speed USB (USB 2.0 compatible) is recommended), DVD burner (CD-ROM drive is necessary for installation)

🔊 Notes

- The above operating environment is for playing movies with [HD SP] image quality (7 Mbps) on a computer.
- Even in a computer environment where the operations are guaranteed, frames may be dropped from movies with HD (high definition) image quality, resulting in uneven playback. However, imported images and images on discs created subsequently will not be affected.
- Operations are not guaranteed, even on computers fulfilling the above system requirements. For example, other open or background applications currently running may limit product performance.
- “Picture Motion Browser” does not support 5.1ch surround sound reproduction. The sound is reproduced in 2ch sound.
- If you use a Notebook PC, connect it to the AC Adaptor as the power source when you view or edit movies recorded in HD (high definition) format. Otherwise, the software will not work properly due to the power saving function of the PC.
- When you perform the One Touch Disc Burn operation, a long scene may be separated into plural discs or scenes, depending on the scene length.
- You can read images recorded on a “Memory Stick PRO Duo” in a Memory Stick slot of a computer. However, in the following cases, do not use the Memory Stick slot of the computer, but connect your camcorder to the computer with the USB cable:
 - The computer is not compatible with a “Memory Stick PRO Duo.”
 - A Memory Stick Duo adaptor is required.
 - A “Memory Stick PRO Duo” cannot be read in the Memory Stick slot.
 - Reading data from the Memory Stick slot is slow.

■ Installation procedure

You need to install the software to your Windows computer **before connecting your camcorder to the computer**. The installation is required only for the first time.

Contents to be installed and procedures may differ depending on your OS.

- ① Confirm that your camcorder is not connected to the computer.

- ② Turn on the computer.

🔊 Notes

- Log on as an Administrator for installation.
 - Close all applications running on the computer before installing the software.
- ③ Place the supplied CD-ROM in the disc drive of your computer.
The installation screen appears.



If the screen does not appear

- ① Click [Start], then click [My Computer]. (For Windows 2000, double-click [My Computer].)
- ② Double-click [SONYPICUTIL (E:)] (CD-ROM) (disc drive).
 - * Drive names (such as (E:)) may vary depending on the computer.
- ④ Click [Install].
- ⑤ Select the language for the application to be installed, then click [Next].
- ⑥ Check your area and country/region, then click [Next].
- ⑦ Read [License Agreement], select [I accept the terms of the license agreement] if you agree, then click [Next].
- ⑧ Connect your camcorder to the computer following the steps below.
 - ① Connect the AC Adaptor to the Handycam Station and a wall socket.
 - ② Set the camcorder onto the Handycam Station, then slide the POWER switch to turn on.
 - ③ Connect the Ψ (USB) jack (p. 17) of the Handycam Station to the computer using the supplied USB cable.
- ⑨ When [Connecting...] appears on the screen of the camcorder, click [Next] on the connection confirmation screen of the computer.

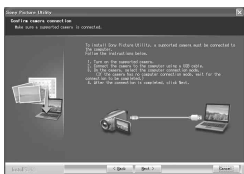

Notes

- Even if a screen prompting you to restart your computer appears, you do not need to restart it at this time. Restart your computer after completing the installation.
 - It may take some time for the authentication.
- ⑩ Follow the on-screen instructions to install the software.
- One of the following installation screens appears, depending on the computer environment. Check the screen and follow the instructions displayed to install the required software.

- Sonic UDF Reader*
Software required to recognize an AVCHD format disc
 - Windows Media Format 9 Series Runtime (Windows 2000 only)
Software required to create a DVD
 - Microsoft .NET Framework 1.1*
Software required to create an AVCHD format disc
 - Microsoft DirectX 9.0c*
Software required to handle movies
- * Windows 2000, Windows XP only

- ⑪ Restart the computer if required to complete the installation.



- ⑫ Remove the CD-ROM from the disc drive of your computer.

Operating the Picture Motion Browser

After you install the software, shortcut icons for “Picture Motion Browser” and “Picture Motion Browser Guide” are created on the desktop.

For the basic operation of “Picture Motion Browser,” see “Picture Motion Browser Guide.”



Double-click to start “Picture Motion Browser.”



Double-click to start “Picture Motion Browser Guide.”

Connecting your camcorder to a computer

To connect your camcorder to a computer, follow the steps below.

- ① Connect the AC Adaptor to the Handycam Station and a wall socket.
 - ② Set the camcorder onto the Handycam Station, then slide the POWER switch to turn on your camcorder.
 - ③ Connect the USB jack (p. 17) of the Handycam Station to a computer using the supplied USB cable.
- The [USB SELECT] screen appears on your camcorder. Touch the item you want to operate on the screen.

Tips

- If the [USB SELECT] screen does not appear, touch (HOME) → (OTHERS) → [COMPUTER].

Recommended USB cable connection

To assure the proper functioning of your camcorder, connect your camcorder to a computer as below.

- Connect the USB ports of the Handycam Station and a computer using the USB cable. Do not connect anything to other USB ports of a computer.

- When connecting to a computer with a USB keyboard and USB mouse connected as standard equipment, connect the Handycam Station to another USB port using the USB cable.

🔊 Notes

- Operations are not guaranteed when multiple USB devices are connected to a computer.
- Be sure to connect the USB cable to a USB port. If the USB cable is connected to a computer via a USB keyboard or USB hub, operations are not guaranteed.

To disconnect the USB cable

- ① Click the [Unplug or eject hardware] icon on the task tray on the bottom right of the desk top.



- ② Click [Safely remove USB Mass Storage Device].

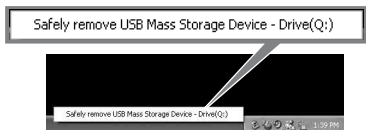

- ③ Click [OK] (Windows 2000 only).
- ④ Touch [END] on the screen of your camcorder.
- ⑤ Touch [YES] on the screen of your camcorder.
- ⑥ Disconnect the USB cable from the Handycam Station and the computer.

🔊 Notes

- Do not disconnect the USB cable while the access lamp is lit.
- Before turning off your camcorder, disconnect the USB cable following the proper procedures described above.
- Disconnect the USB cable using the proper procedures described above. Otherwise, files

stored on the "Memory Stick PRO Duo" may not be updated correctly. Also, disconnecting the USB cable improperly may cause a malfunction of the "Memory Stick PRO Duo."

Troubleshooting

If you run into any problems using your camcorder, use the following table to troubleshoot the problem. If the problem persists, disconnect the power source and contact your Sony dealer.

Menu items are grayed out.

- There are some functions you cannot activate simultaneously. For details, see “Handycam Handbook” (PDF).

The power does not turn on.

- Attach a charged battery pack to the camcorder (p. 6).
- Connect the plug of the AC Adaptor to the wall socket (p. 6).
- Set the camcorder onto the Handycam Station securely (p. 6).

The camcorder does not operate even when the power is set to on.

- It takes a few seconds for your camcorder to be ready to shoot after the power is turned on. This is not a malfunction.
- Disconnect the AC Adaptor from the wall socket or remove the battery pack, then reconnect it after about 1 minute. If the functions still do not work, press the RESET button (p. 16) using a pointed object. (If you press the RESET button, all settings, including the clock setting, are reset.)

Buttons do not work.

- During Easy Handycam operation, available buttons/functions are limited. Cancel Easy Handycam operation. For details on Easy Handycam operation, refer to “Handycam Handbook” (PDF).

Your camcorder gets warm.

- This is because the power has been turned on for a long time. This is not a malfunction.



The power abruptly turns off.

- When approximately 5 minutes have elapsed while you do not operate your camcorder, the camcorder is

automatically turned off (A.SHUT OFF). Change the setting of [A.SHUT OFF], or turn on the power again, or use the AC Adaptor.

- Charge the battery pack (p. 6).

Pressing START/STOP or PHOTO does not record images.

- The playback screen is displayed. Set the POWER switch to  (Movie) or  (Still) (p. 11).
- Your camcorder is recording the image you have just shot on the “Memory Stick PRO Duo.” You cannot make new recording during this period.
- The “Memory Stick PRO Duo” is full. Use a new “Memory Stick PRO Duo” or format the “Memory Stick PRO Duo.” Or delete the unnecessary images (p. 23).
- Total number of movie scenes or still images exceeds the recordable capacity of your camcorder. Delete the unnecessary images (p. 23).

You cannot install “Picture Motion Browser.”

- Check the computer environment required to install “Picture Motion Browser.”
- Install “Picture Motion Browser” in an orderly manner (p. 26).

“Picture Motion Browser” does not work correctly.

- Finish “Picture Motion Browser” and restart your computer.

Your camcorder is not recognized by the computer.

- Install “Picture Motion Browser” (p. 26).
- Disconnect devices from the USB jack of the computer other than the keyboard, mouse, and your camcorder.
- Disconnect the USB cable from the computer and the Handycam Station, and restart the computer, then connect the computer and your camcorder again in an orderly manner (p. 27).

- Make sure the media check tool of the computer activates. For details on the media check tool, see “Picture Motion Browser Guide.”

Self-diagnosis display/Warning indicators

If indicators appear on the LCD screen, check the following. You can fix some symptoms by yourself. If the problem persists even after you have tried a couple of times, contact your Sony dealer or local authorized Sony service facility.

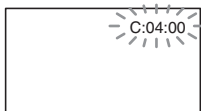

C:(or E): □□:□□ (Self-diagnosis display)

C:04:□□

- The battery pack is not an “InfoLITHIUM” battery pack (H series). Use an “InfoLITHIUM” battery pack (H series) (p. 6).
- Connect the DC plug of the AC Adaptor to the DC IN jack of the Handycam Station or your camcorder securely (p. 6).

C:13:□□ / C:32:□□

- Remove the power source. Reconnect it and operate your camcorder again.

E:20:□□ / E:31:□□ / E:61:□□ / E:62:□□ / E:91:□□ / E:94:□□

- A malfunction that you cannot service has occurred. Contact your Sony dealer or local authorized Sony service facility. Inform them of the 5-digit code, which starts from “E.”

101-0001 (Warning indicator pertaining to files)

- The file is damaged.*1
- The file is unreadable.*1

⚠ (Battery level warning)

- The battery pack is nearly used up.*1
- Depending on the operating environment or battery conditions, ⚠ may flash, even if there are approximately 20 minutes remaining.*1

⚠ (Warning indicator pertaining to “Memory Stick PRO Duo”)

- Free space for recording images are running out.
- There are not enough free spaces for recording images. Insert a new “Memory Stick PRO Duo,” delete unnecessary images, or format the “Memory Stick PRO Duo” (p. 23).*2
- No “Memory Stick PRO Duo” is inserted (p. 10).*1

⚠ (Warning indicators pertaining to “Memory Stick PRO Duo” formatting)*3

- The “Memory Stick PRO Duo” is damaged.
- The “Memory Stick PRO Duo” is not formatted correctly.

⚠ (Warning indicator pertaining to incompatible “Memory Stick PRO Duo”)*3

- An incompatible “Memory Stick PRO Duo” is inserted.

⚠ (Warning indicator pertaining to the write-protect of the “Memory Stick PRO Duo”)*3

- Access to the “Memory Stick PRO Duo” was restricted on another device.

⚠ (Warning indicator pertaining to the Memory Stick Duo cover)

- The Memory Stick Duo cover is open (p. 10).*1

⚠ (Warning indicator pertaining to the flash)

- There is something wrong with the flash.*2*3

(Warning indicator pertaining to camera-shake warning)

- The amount of light is not sufficient, so camera-shake easily occurs. Use the flash.
- The camcorder is unsteady, so camera-shake easily occurs. Hold the camcorder steady with both hands and record the image. However, note that the camera-shake warning indicator does not disappear.

*1 Slow flashing

*2 Fast flashing

*3 You hear a melody when the warning indicators appear on the screen.

Precautions

On use and care

- Do not use or store the camcorder and accessories in the following locations:
 - Anywhere extremely hot, cold or humid. Never leave them exposed to temperatures above 60°C (140°F), such as under direct sunlight, near heaters or in a car parked in the sun. They may malfunction or become deformed.
 - Near strong magnetic fields or mechanical vibration. The camcorder may malfunction.
 - Near strong radio waves or radiation. The camcorder may not be able to record properly.
 - Near AM receivers and video equipment. Noise may occur.
 - On a sandy beach or anywhere dusty. If sand or dust gets in your camcorder, it may malfunction. Sometimes this malfunction cannot be repaired.
 - Near windows or outdoors, where the LCD screen, or the lens may be exposed to direct sunlight. This damages the LCD screen.
- Operate your camcorder on DC 6.8 V/7.2 V (battery pack) or DC 8.4 V (AC Adaptor).
- For DC or AC operation, use the accessories recommended in these operating instructions.
- Do not let your camcorder get wet, for example, from rain or sea water. If your camcorder gets wet, it may malfunction. Sometimes this malfunction cannot be repaired.
- If any solid object or liquid gets inside the casing, unplug your camcorder and have it checked by a Sony dealer before operating it any further.
- Avoid rough handling, disassembling, modifying, physical shock, or impact such as hammering, dropping or stepping on the product. Be particularly careful of the lens.
- Keep the POWER switch setting to OFF (CHG) when you are not using your camcorder.
- Do not wrap your camcorder with a towel, for example, and operate it. Doing so might cause heat to build up inside.
- When disconnecting the mains lead, pull it by the plug and not the cord.
- Do not damage the mains lead such as by placing anything heavy on it.
- Keep metal contacts clean.
- Keep the Remote Commander and button-type battery out of children's reach. If the battery is

accidentally swallowed, consult a doctor immediately.

- If the battery electrolytic liquid has leaked:
 - consult your local authorized Sony service facility.
 - wash off any liquid that may have contacted your skin.
 - if any liquid gets in your eyes, wash with plenty of water and consult a doctor.

■ When not using your camcorder for a long time

- Periodically turn on your camcorder and let it run such as by playing back or recording images for about 3 minutes.
- Use up the battery pack completely before storing it.

LCD screen

- Do not exert excessive pressure on the LCD screen, as it may cause damage.
- If your camcorder is used in a cold place, a residual image may appear on the LCD screen. This is not a malfunction.
- While using your camcorder, the back of the LCD screen may heat up. This is not a malfunction.

■ To clean the LCD screen

If fingerprints or dust make the LCD screen dirty, it is recommended you use a soft cloth to clean it. When you use the LCD Cleaning Kit (optional), do not apply the cleaning liquid directly to the LCD screen. Use cleaning paper moistened with the liquid.

On handling the casing

- If the casing is soiled, clean the camcorder body with a soft cloth lightly moistened with water, and then wipe the casing with a dry soft cloth.
- Avoid the following to avoid damage to the finish:
 - Using chemicals such as thinner, benzene, alcohol, chemical cloths, repellent, insecticide and sunscreen.
 - Handling the camcorder with above substances on your hands.
 - Leaving the casing in contact with rubber or vinyl objects for a long period of time.

About care and storage of the lens

- Wipe the surface of the lens clean with a soft cloth in the following instances:
 - When there are fingerprints on the lens surface.
 - In hot or humid locations
 - When the lens is exposed to salty air such as at the seaside.
- Store in a well-ventilated location subject to little dirt or dust.
- To prevent mold, periodically clean the lens as described above. It is recommended that you operate your camcorder about once a month to keep it in optimum state for a long time.

On charging the pre-installed rechargeable battery

Your camcorder has a pre-installed rechargeable battery to retain the date, time, and other settings even when the POWER switch is set to OFF (CHG). The pre-installed rechargeable battery is always charged while your camcorder is connected to the wall socket via the AC Adaptor or while the battery pack is attached. The rechargeable battery will be fully discharged in **about 3 months** if you do not use your camcorder at all. Use your camcorder after charging the pre-installed rechargeable battery. However, even if the pre-installed rechargeable battery is not charged, the camcorder operation will not be affected as long as you are not recording the date.

■ Procedures

Connect your camcorder to a wall socket using the supplied AC Adaptor, and leave it with the POWER switch set to OFF (CHG) for more than 24 hours.

To change the battery of the Remote Commander

- ① While pressing on the tab, inset your fingernail into the slit to pull out the battery case.
- ② Place a new battery with the + side facing up.
- ③ Insert the battery case back into the Remote Commander until it clicks.

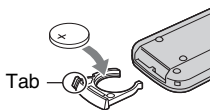

WARNING

Battery may explode if mistreated. Do not recharge, disassemble or dispose of in fire.

- When the lithium battery becomes weak, the operating distance of the Remote Commander may shorten, or the Remote Commander may not function properly. In this case, replace the battery with a Sony CR2025 lithium battery. Use of another battery may present a risk of fire or explosion.

Specifications

System

Video compression format

AVCHD (HD)/MPEG2 (SD)/JPEG (Still images)

Audio compression format

Dolby Digital 2/5.1ch
Dolby Digital 5.1 Creator

Video signal

PAL color, CCIR standards
1080/50i specification

Recording format

Movie (HD): AVCHD 1080/50i
Movie (SD): MPEG2-PS
Still image: Exif Ver.2.2^{*1}

Image device

6.3 mm (1/2.9 type) CMOS sensor
Recording pixels (still image, 4:3):
Max. 6.1 mega (2 848 × 2 136) pixels*²
Gross: Approx. 3 200 000 pixels
Effective (movie, 16:9):
2 280 000 pixels
Effective (movie, 4:3):
1 710 000 pixels
Effective (still image, 16:9):
2 280 000 pixels
Effective (still image, 4:3):
3 040 000 pixels

Lens

Carl Zeiss Vario-Sonnar T*
10 × (Optical), 20 × (Digital)

Focal length

F1.8 ~ 2.9
Filter diameter: 37 mm (1 1/2 in.)
f=5.4 ~ 54 mm (7/32 ~ 2 1/4 in.) When converted to a 35 mm still camera
For movies: 40 ~ 400 mm (1 5/8 ~ 15 3/4 in.) (16:9), 49 ~ 490 mm (1 15/16 ~ 19 3/8 in.) (4:3)
For still images: 40 ~ 400 mm (1 5/8 ~ 15 3/4 in.) (16:9), 37 ~ 370 mm (1 1/2 ~ 14 5/8 in.) (4:3)

Color temperature

[AUTO], [ONE PUSH],
[INDOOR] (3 200 K),
[OUTDOOR] (5 800 K)

Minimum illumination

2 lx (lux) ([AUTO SLW SHUTTR] [ON],
Shutter speed 1/25 sec)
0 lx (lux) (during NightShot function)

*1 "Exif" is a file format for still images, established by the JEITA (Japan Electronics and Information Technology Industries Association). Files in this format can have additional information such as your camcorder's setting information at the time of recording.

*2 The unique pixel array of Sony's ClearVid CMOS sensor and image processing system (new Enhanced Imaging Processor) allows still image resolution equivalent to the sizes described.

Input/Output connectors

Audio/Video output

10-pin connector
Video signal: 1 Vp-p, 75 Ω (ohms)
Luminance signal: 1 Vp-p, 75 Ω (ohms)
Chrominance signal: 0.3 Vp-p, 75 Ω (ohms)
Audio signal: 327 mV (at load impedance 47 kΩ (kilohms)), Output impedance with less than 2.2 kΩ (kilohms)

HDMI OUT jack

HDMI Type C mini connector

LCD screen

Image

6.7 cm (2.7 type, aspect ratio 16:9)

Total dot number

211 200 (960 × 220)

General

Power requirements

DC 6.8 V/7.2 V (battery pack)
DC 8.4 V (AC Adaptor)

Average power consumption

During camera recording using the LCD with normal brightness:

HD: 4.3 W
SD: 3.8 W

Operating temperature

0 °C to +40 °C (32 °F to 104 °F)

Storage temperature

-20 °C to +60 °C (-4 °F to +140 °F)

Dimensions (approx.)

69 × 67 × 129 mm
(2 3/4 × 2 3/4 × 5 1/8 in.) (w/h/d)
including the projecting parts
69 × 67 × 131 mm
(2 3/4 × 2 3/4 × 5 1/4 in.) (w/h/d)

including the projecting parts, and the NP-FH60 rechargeable battery pack attached

Mass (approx.)

370 g (13 oz) main unit only
450 g (15 oz) including the NP-FH60 rechargeable battery pack, and a "Memory Stick PRO Duo"

Handycam Station DCRA-C191

Input/Output connectors

Audio/Video output

10 pin connector
Video signal: 1 Vp-p, 75 Ω (ohms)
Luminance signal: 1 Vp-p, 75 Ω (ohms)
Chrominance signal: 0.3 Vp-p, 75 Ω (ohms)
Audio signal: 327 mV (at load impedance 47 kΩ (kilohms)), Output impedance with less than 2.2 kΩ (kilohms)

COMPONENT OUT jack

Y: 1 Vp-p, 75 Ω (ohms)
PB/PR, CB/CR: +/- 350 mV, 75 Ω (ohms)

USB jack

mini-B
HDR-CX6EK: You cannot input signals to your camcorder through this jack.

AC Adaptor AC-L200/L200B

Power requirements

AC 100 V - 240 V, 50/60 Hz

Current consumption

0.35 - 0.18 A

Power consumption

18 W

Output voltage

DC 8.4 V*

Operating temperature

0 °C to +40 °C (32 °F to 104 °F)

Storage temperature

-20 °C to +60 °C (-4 °F to +140 °F)

Dimensions (approx.)

48 × 29 × 81 mm
(1 15/16 × 1 3/16 × 3 1/4 in.) (w/h/d)
excluding the projecting parts

Mass (approx.)

170 g (6.0 oz) excluding the mains lead

* See the label on the AC Adaptor for other specifications.

Rechargeable battery pack NP-FH60

Maximum output voltage

DC 8.4 V

Output voltage

DC 7.2 V

Capacity

7.2 Wh (1 000 mAh)

Dimensions (approx.)

31.8 × 33.3 × 45.0 mm
(1 5/16 × 1 5/16 × 1 13/16 in.) (w/h/d)

Mass (approx.)

80 g (2.9 oz)

Operating temperature

0 °C to +40 °C (32 °F to 104 °F)

Type

Lithium ion

Design and specifications are subject to change without notice.

- Your camcorder is produced under the license of Dolby Laboratories.

Notice for the customers in the countries applying EU Directives

The manufacturer of this product is Sony Corporation, 1-7-1 Konan Minato-ku Tokyo, 108-0075 Japan. The Authorized Representative for EMC and product safety is Sony Deutschland GmbH, Hedelfinger Strasse 61, 70327 Stuttgart, Germany. For any service or guarantee matters please refer to the addresses given in separate service or guarantee documents.

On trademarks

- “Handycam” and **HANDYCAM** are registered trademarks of Sony Corporation.
- “AVCHD” and “AVCHD” logotype are trademarks of Matsushita Electric Industrial Co., Ltd. and Sony Corporation.
- “Memory Stick,” “,” “Memory Stick Duo,” “**MEMORY STICK DUO**,” “Memory Stick PRO Duo,” “**MEMORY STICK PRO DUO**,” “Memory Stick PRO-HG Duo,” “**MEMORY STICK PRO-HG DUO**,” “Memory Stick Micro,” “MagicGate,” “**MAGIC GATE**,” “MagicGate Memory Stick” and “MagicGate Memory Stick Duo” are trademarks or registered trademarks of Sony Corporation.
- “x.v.Colour” is a trademark of Sony Corporation.
- “InfoLITHIUM” is a trademark of Sony Corporation.
- Dolby and the double-D symbol are trademarks of Dolby Laboratories.
- Dolby Digital 5.1 Creator is a trademark of Dolby Laboratories.
- HDMI, the HDMI logo and High-Definition Multimedia Interface are trademarks or registered trademarks of HDMI Licensing LLC.
- Microsoft, Windows, Windows Media, Windows Vista, and DirectX are either registered trademarks or trademarks of Microsoft Corporation in the United States and/or other countries.
- Macintosh and Mac OS are registered trademarks of Apple Inc. in the U.S. and other countries.
- Intel, Intel Core, and Pentium are trademarks or registered trademarks of Intel Corporation or its

subsidiaries in the United States and other countries.

- Adobe, the Adobe logo, and Adobe Acrobat are either registered trademarks or trademarks of Adobe Systems Incorporated in the United States and/or other countries.

All other product names mentioned herein may be the trademarks or registered trademarks of their respective companies. Furthermore, TM and [®] are not mentioned in each case in this manual.

Additional information on this product and answers to frequently asked questions can be found at our Customer Support Website.

<http://www.sony.net/>



Printed on 70% or more recycled paper
using VOC (Volatile Organic Compound)-
free vegetable oil based ink.

Printed in Japan



3214661120