

Cautions

Listening Precautions

- Do not play your headphones at a high volume. Hearing experts advise against continuous extended play.
- If you experience a ringing in your ears, reduce volume or discontinue use.
- Do not use while operating a motorized vehicle. It may create a traffic hazard and is illegal in many areas.
- You should use extreme caution or temporarily discontinue use in potentially hazardous situations.
- Even if your headphones is an open-air type designed to let you hear outside sounds, don't turn up the volume so high that you can't hear what's around you.

Rechargeable batteries

- Rechargeable batteries (not supplied) can be used.
- To use the rechargeable batteries, follow the instruction manual attached to the rechargeable batteries and charger (not supplied).

Dry cell batteries

- To prevent damage to the batteries and electrolyte leakage, heed the following points.
- Bathrooms and other moisture-prone places.
 - Warehouses and other dusty places
 - Very hot places near heating appliances, etc.
- Align the ⊕ and ⊖ polarities properly when inserting the batteries.
 - Do not mix different types or makers of batteries or old and new batteries.
 - Remove the batteries if you do not plan to use the unit for a long period of time.
 - Do not throw batteries into a fire, and do not short-circuit, disassemble or subject them to excessive heat.
 - Do not attempt to recharge dry cell batteries.

Carrying dry cell batteries around

When putting dry cell batteries in a pocket or bag, ensure that no other metal objects such as a necklace are placed together with them. Contact with metal may cause short-circuiting which, in turn, may cause a fire.

AC adaptor

- Handle the AC adaptor carefully. Improper handling is dangerous.
 - Do not touch it with wet hands.
 - Do not place heavy objects on top of it.
 - Do not forcibly bend it.
- Be sure to connect only the specified AC adaptor with the unit.
- Disconnect the AC adaptor from the power outlet if the unit is not going to be used for a long time.

Unit

No altering or remodeling

This can cause malfunctioning.

No dropping or strong impacts

This may damage the unit.

Locations to be avoided

Avoid using the unit in the following locations since they can cause malfunctioning.

- Bathrooms and other moisture-prone places.
- Warehouses and other dusty places
- Very hot places near heating appliances, etc.

Do not leave the unit exposed to direct sunlight for long periods of time

This may deform or discolor the cabinet and may also cause malfunctioning.

When purchasing AC adaptor

Be absolutely sure to purchase the AC adaptor designed especially for this unit.

AC adaptor: AA-R4515

For details, check with your dealer.

Precautions

Safety

- Care of AC adaptor** - The cord of the AC adaptor should be routed so that they are not likely to be walked on or pinched by items placed upon or against them. Never take hold of the AC adaptor if your hand is wet, and always grasp the plug when connecting or disconnecting it.
- Disconnect when not in use** - When not in use, be sure to disconnect the AC adaptor from the AC power outlet.
- Batteries** - If the unit is not used for a long period of time or is used only from an AC power source, remove all the batteries to prevent potential damage due to battery leakage. Do not mix (old and new) batteries or different types of batteries.

Installation

■ Environment

- Condensation** - Moisture may form on the lens in the following conditions...
 - immediately after a heater has been turned on.
 - in a steamy or very humid room.
 - when the unit is suddenly moved from a cold environment to a warm one. If moisture forms inside this unit, it may not operate properly. To correct this problem wait about one hour for the moisture to evaporate.

■ Placement

- Foreign Material** - Care should be taken so that objects do not fall into and liquids are not spilled into the unit. Do not subject this unit to excessive smoke, dust, mechanical vibration, or shock.
- Magnetism** - The unit should be situated away from equipment or devices that generate strong magnetic fields.
- Stacking** - Do not place any objects on top of the unit.

Maintenance

(See page 5 for details.)

Clean the cabinet, panel and controls with a soft cloth lightly moistened with mild detergent solution. Do not use any type of abrasive pad, scouring powder or solvent such as alcohol or benzene.

Service

- Damage Requiring Service** - The unit should be serviced by qualified service personnel when:
 - The AC adaptor is damaged; or
 - Objects have fallen or liquid has been spilled into the unit; or
 - The unit has been exposed to rain; or
 - The unit does not appear to operate normally or exhibits a marked change in performance; or
 - The unit has been dropped, or the enclosure damaged.

WARNING:

TO REDUCE THE RISK OF FIRE OR ELECTRIC SHOCK, DO NOT EXPOSE THIS APPLIANCE TO RAIN OR MOISTURE.

CAUTION!

THIS PRODUCT UTILIZES A LASER. USE OF CONTROLS OR ADJUSTMENTS OR PERFORMANCE OF PROCEDURES OTHER THAN THOSE SPECIFIED HEREIN MAY RESULT IN HAZARDOUS RADIATION EXPOSURE. DO NOT OPEN COVERS AND DO NOT REPAIR YOURSELF. REFER SERVICING TO QUALIFIED PERSONNEL.

CAUTION:

- Do not block the ventilation opening or holes. (If the ventilation openings of holes are blocked by a newspaper or cloth, etc., the heat may not be able to get out.)
- Do not place any naked flame sources, such as lighted candles, on the apparatus.
- When discarding batteries, environmental problems must be considered and local rules or laws governing the disposal of these batteries must be followed strictly.
- Do not expose this apparatus to rain, moisture, dripping or splashing and that no objects filled with liquids, such as vases, shall be placed on the apparatus.

IMPORTANT FOR LASER PRODUCTS

- CLASS 1 LASER PRODUCT
- CAUTION:** Do not open the top cover. There are no user serviceable parts inside the unit; leave all servicing to qualified service personnel.
- CAUTION:** Visible and invisible laser radiation when open and interlock failed or defeated. Avoid direct exposure to beam.
- REPRODUCTION OF LABEL: CAUTION LABEL, PLACED OUTSIDE THE UNIT.

CAUTION: Visible and invisible laser radiation when open and interlock failed or defeated. AVOID DIRECT EXPOSURE TO BEAM. (e)	WARNING: Synlig Och osynlig laserstrålning när den öppnas och spärren är urkopplad. Betrakta ej strålen. (s)
--	---

ADVASEL: Synlig og usynlig laserstrålning når maskinen er åben eller interlocken fejle. Undgå direkte eksponering tti stråling. (d)	VARO: Avattaessa ja Suojalukitus ohitettunatai viallisena olet alttiina näkyvälle ja näkymättömälle lasersäteilylle. Vältä säteen kohdistumista suoraan itseesi. (f)
--	---

Concerning Compact Discs

Only compact discs bearing this mark can be used with this unit.



However, continued use of irregular shape CDs (heart-shape, octagonal, etc.) can damage the unit.

CD-R and CD-RW discs recorded with the audio CD format can be played back, though some may not be played back because of the disc characteristics or recording condition.

How to remove a disc from its case



How to store the disc in its case



How to hold a disc

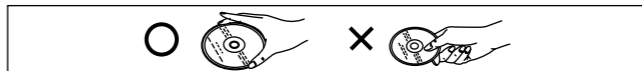

If the disk surface is dirty

Wipe it with a damp cloth and then wipe dry. Wipe from the center toward the outer edge.

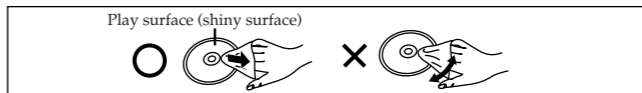

If moisture has formed on a disc

When moisture has formed because the disc was brought suddenly into a warm room from a cold environment, wipe off the moisture using a soft dry cloth.

When storing discs

- Avoid locations which are
- Exposed to direct sunlight.
 - Susceptible to high levels of humidity or dust.
 - Directly exposed to heat from a heating appliance.
 - On top of a car dashboard or near the rear window.

Handling precautions

- On the label side (the side with writing) Do not write anything using a pencil, ball-point pen, etc. Do not use adhesive paper or labels.
- On the disc (shiny) side Handle this side carefully to keep it free from fingerprints or scratches. Do not use record cleaners, solvents, etc.
- Do not attach labels or stickers to CDs. Do not use CDs with exposed adhesive from tape or left over peeled off stickers.
- Do not use scratch-proof protectors or covers other than those specified for use with this unit.

Specifications

Portable CD player

Type	: Compact disc player
Signal detection system	: Non-contact optical pickup (semiconductor laser)
Pickup system	: 3 beam laser
Number of channels:	: 2 channels (stereo)
Frequency response	: 20 Hz to 20 kHz
Wow & flutter	: Unmeasurable
Output	: Headphones (3.5 mm dia. stereo × 1) 9 mW/ch at 10 % THD/16 Ω matching impedance (16 Ω to 1 kΩ) 87.5 MHz - 108.0 MHz
FM tuning range	: 87.5 MHz - 108.0 MHz
Duration of battery (with Anti-Shock Protection EX OFF)	: Approx. 20 hours when using two alkaline batteries (LR6)
Power requirements	: DC 3 V ("R6" size battery × 2) DC 2.4V (rechargeable battery × 2) DC IN 4.5 V
Dimensions (W×H×D)	: 145.5 mm ×32.1 mm ×145.5 mm (Excluding buttons and controls)
Mass	: 300 g (with grip band, without batteries)

AC adaptor (not supplied)

Input power source : AC 230 V, 50 Hz
Output voltage : DC 4.5 V, 600 mA

* Design and specifications are subject to change without notice.

JVC

PORTABLE CD PLAYER XL-PR2B

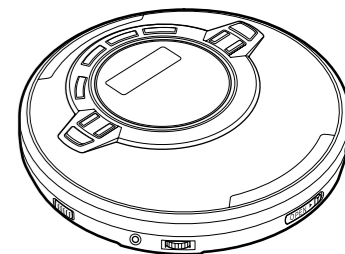

INSTRUCTIONS



Supplied Accessories

Stereo headphones 1 pc.

Thank you for purchasing this JVC product. Please read these instructions carefully before starting operation to be sure to obtain optimum performance and a longer service life from the unit.

LVT1180-004B [B]

0404SKMCREORI
EN ©2004 VICTOR COMPANY OF JAPAN, LIMITED

Put the grip band on your hand

Adjust the grip band to your hand size.

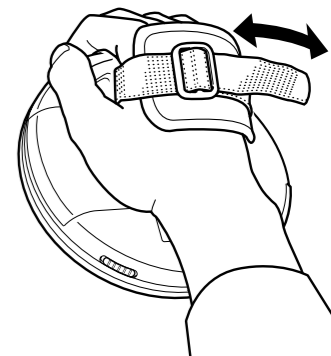

Troubleshooting

Problem	Check this
Poor tuner reception	<ul style="list-style-type: none">Extend the headphone cord (antenna) to improve reception.
Does not turn on.	<ul style="list-style-type: none">Is the AC adaptor securely connected?Is the HOLD switch set to OFF position?
Cannot close the lid.	Is the disc properly secured in place?
Cannot play discs.	<ul style="list-style-type: none">Is the disc properly secured in place?Is there moisture condensation on the lens? (Wait for about an hour and then try again.)
Cannot hear music—too noisy.	<ul style="list-style-type: none">Is the headphone plug inserted all the way?Is the plug dirty? (Wipe away dirt on the plug.)
TV picture is distorted. Other radio reception is noisy.	Are you using the unit too near a TV or tuner? (If the TV or tuner is connected to a simple indoor antenna, connect it to an outdoor antenna.)
"dISC" or "Er" is displayed when a disc is in the player.	<ul style="list-style-type: none">Is the disc damaged?Is the disc playable on this player?Has the disc been inserted upside down?

If the remedies indicated in the chart do not solve the problem, refer to the directory of Authorized Service Centers (enclosed with this unit) to locate a convenient service center, or consult your dealer for instructions.

Maintenance

Unit

Wipe the unit with a soft cloth. Remove stubborn dirt using a cloth which has been dipped in water or soapy water and wrung out, and then wipe dry.

- If you intend to use a chemically treated cleaning cloth, read its directions first.
- Do not use alcohol or paint thinners.

Lens

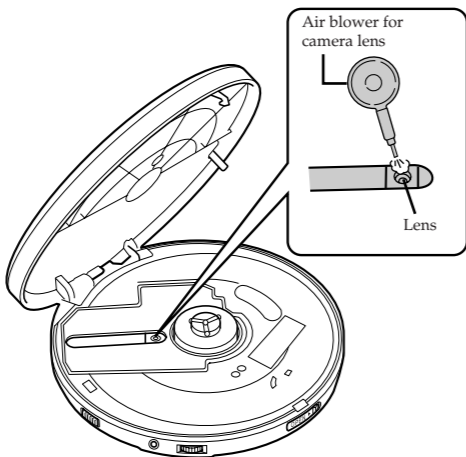

Power Supply Preparations

The illustration of the grip band is omitted.

Using dry-cell batteries (not supplied)

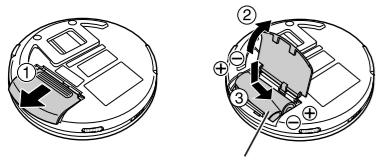

Two "R6" (LR6) alkaline batteries.

Caution:

Do not forcibly open the battery lid too wide.

Battery indicator

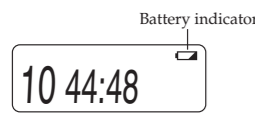

This indicator appears when the batteries are almost out of power. Power will be cut off a short while later.

Note:

Turning off the Anti-Shock Protection EX will save the battery power more or less. For details, see "Anti-shock Protection EX" on page 4.

Using the AC adaptor (not supplied)

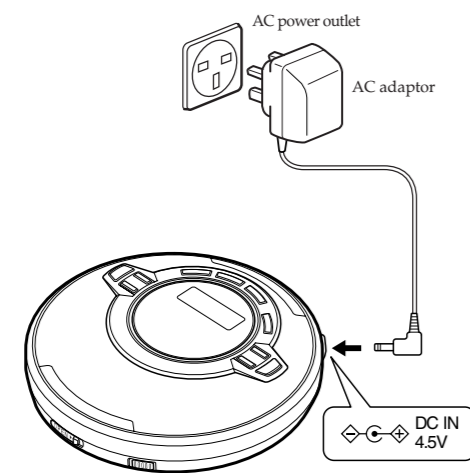

Notes:

- Even if the unit is turned off, small power is consumed as long as the AC adaptor is connected to the AC power outlet.
- When you want to purchase the AC adaptor, see page 5.

Tuner Operation

You can listen to FM stations by tuning in manually, automatically, or using preset memory. For best reception, extend the headphone cord (antenna).

Manual/Auto tuning

1



2 Select a station.

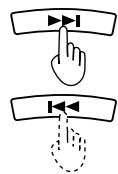

Manual tuning

Press ►| or |◄ repeatedly to select a station you want.

Auto tuning

Hold down ►| or |◄ for a while and then release it. The frequency automatically changes up or down to find the next station.

Presetting stations

You can preset up to 20 stations (frequencies).

1 Select the station you want to preset. Use Manual or Auto tuning mentioned earlier.

2



3 Select the preset number (01-20) you want.

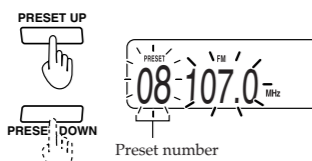

4 Press PROGRAM.

Preset tuning

1



2 Select the preset number you want.

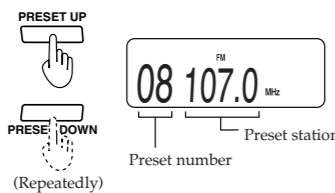

Changing the FM reception mode

When a broadcast is in stereo, "ST." lights up and you can hear stereo effects. However, if an FM stereo broadcast is hard to receive or noisy, you can select monaural (MONO) mode. Reception improves, but you lose the stereo effect.

To select the monaural mode

"MONO" appears.



To cancel the monaural mode

Press MODE once again. "MONO" will go out. The monaural mode is cancelled also by changing the frequency.

Turning off the unit



- When the unit malfunctions or freezes during use, disconnect the power source (the AC adaptor and batteries) once. Then, re-connect the power source and continue operation.
- If tuner operation is abnormal, press the RESET switch to reset the unit.

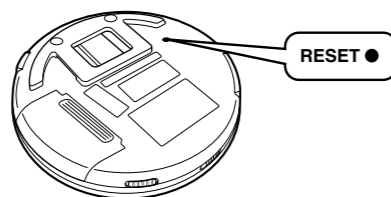

Note:

The preset broadcast stations you have made will be cleared by the reset operation.

Basic Play

The illustration of the grip band is omitted.

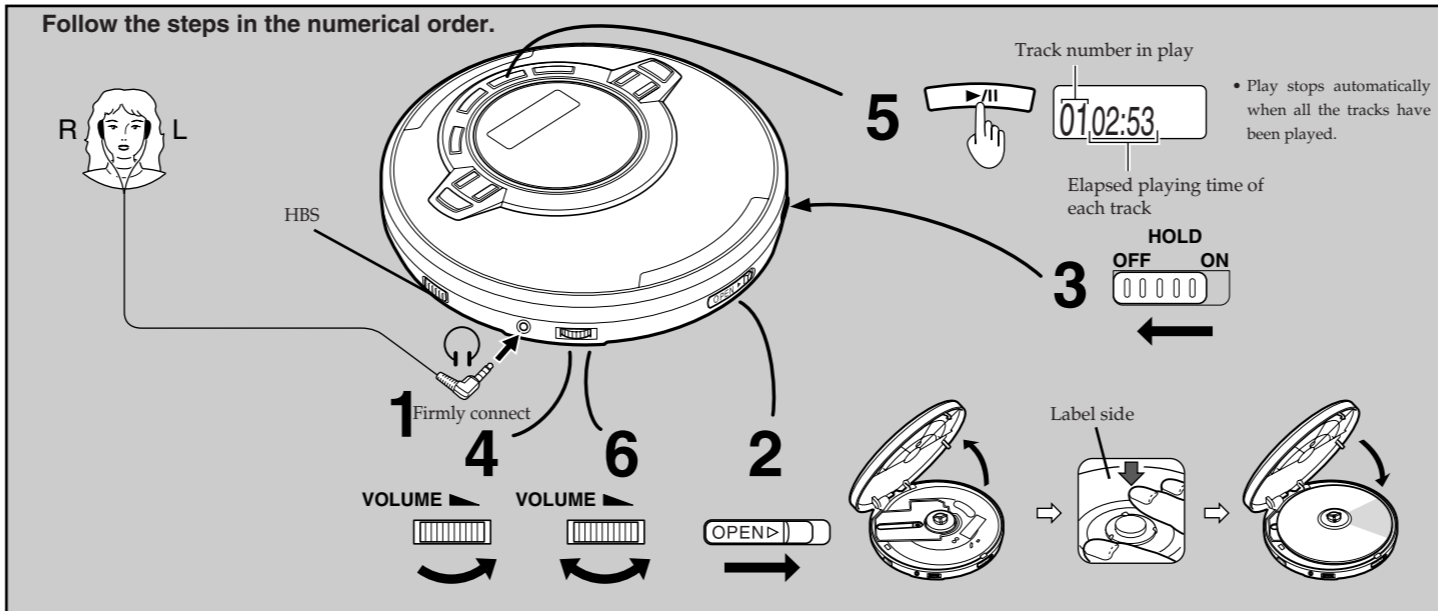

Operation	Button	Display/reference
To pause	During play, Press again to restart play.	
To stop	During play,	Total number of tracks Total playing time
To turn off the unit	While stopped,	No indication
Fast forward/reverse	During play, Forward Reverse Search function Keep depressed during play.	<ul style="list-style-type: none"> • To skip back to the previous track, quickly press twice. • During Program play, the button is used to fast forward or back through the programmed sequence of tracks. • During Random play, the skip button cannot be used to skip back to tracks that were played previously in the random sequence.

For your reference:

"disc"

This indication appears if ►| is pressed when no disc is loaded or if the disc is not properly seated.

"_ _"

Preparation period before playing the track
Flashes for several seconds after pressing ►| to play.

"OPEN"

This indication appears when the lid is open.

Removing discs

Turn off the unit and, after the disc has stopped rotating, remove the disc as shown below:

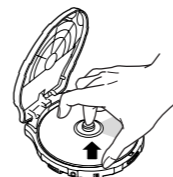

Auto power off

If the unit is left in stop mode for 30 seconds, the unit turns itself off automatically to prevent the batteries from running down.

Disc rotation noise

The portable CD player uses a power-saving operation method so that disc rotation noise will intermittently be emitted. But, it is not a failure.

Other Play Methods

Intro play

You can successively play the first 10 seconds of every track.

1 While stopped,



(Repeatedly)

2

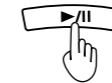

To cancel

Press MODE repeatedly until "INTRO" goes out.

Notes:

- You can also select Intro play during playback. In this case, Intro play will start from the next track after the current track has finished.
- You can also select Intro play during Program play mode.

Random play

During playback,

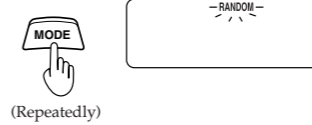

(Repeatedly)

After playing all tracks, the unit stops.

To cancel

Press MODE until "RANDOM" goes out, or press to stop the disc.

Notes:

- You can also select Random play in stop mode.
- During Program play, you can not select Random play.

Repeat play

You can repeat one track or all tracks.

During playback,

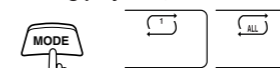

To cancel

Press MODE repeatedly until the repeat indicator goes out.

Notes:

- You can also select Repeat play during Program play.
- You can also select Repeat play while stopped.

Program play

You can program up to 24 tracks in any desired order including the same tracks.

1 While stopped,

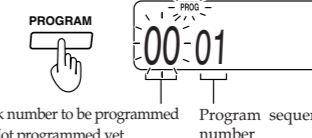

Track number to be programmed
00: Not programmed yet.

Program sequence number

2 Select the desired track.

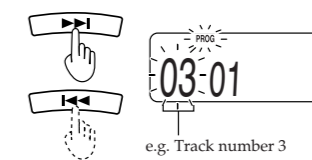

e.g. Track number 3

3



Next program sequence number

The track is registered.

4 Repeat steps 2 and 3.

When you program exceeding 24 tracks, the program sequence number returns to "01" and will overwrite the previous setting.

5

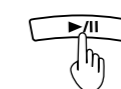

To confirm the program

While stopped, press PROGRAM repeatedly. At this time, you can add and change the program, if required.

To delete the entire program

Turn off the unit.

Hyper-Bass Sound effect

You can enjoy powerful bass sound.



Anti-Shock Protection EX

This function achieves excellent performance against sound interruption caused by vibrations. You will be able to enjoy listening to music during (not vigorous) jogging. By utilizing the high-performance servo circuit, audio data will be stored in the memory ahead of time (up to 45 seconds worth). Normally, this function is in effect.



As the audio data is gradually stored, the indicator changes as follows:

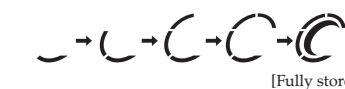

[Fully stored]

To cancel



The "ANTI SHOCK" indicator goes out.

To activate again

Press the ASP button.

Notes:

- During this operation, the disc rotates at a higher rate than usual in order to collect extra audio data. This may cause the batteries to run out faster and could result in a slight increase in disc rotation noise.
- This function can be switched ON and OFF during playback. However, this may cause a slight interruption in the sound because the disc's rotational speed changes.

Preventing Accidental Operation (Hold mode)

This function causes the unit to ignore, accidental button presses.

Hold mode prevents the following:

- Powering on the unit accidentally (which can cause the batteries to go dead).
- Play being cut off unexpectedly.

To use the Hold mode

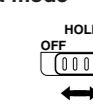

To confirm the program

While stopped, press PROGRAM repeatedly. At this time, you can add and change the program, if required.

To delete the entire program

Turn off the unit.

Hyper-Bass Sound effect

You can enjoy powerful bass sound.



Notes:

- Before turning on the unit, be sure that HOLD is OFF. Otherwise, you cannot turn on the unit.