



PERSONAL COMPACT DISC PLAYER
with 45 SECOND ANTI-SKIP MEMORY

OWNER'S MANUAL

HD2850

Visit our web site at www.emersonradio.com



Thank you.....

For purchasing this Emerson Personal CD Player. It has a 24 track programmable memory so you can listen to the songs on your favorite CD's in any order you choose. Or you can use the Random playback feature and let the player select the playback order for you. Use the 3-way Repeat feature to repeat a single track, the entire disc, or a programmed sequence of tracks, indefinitely. We've also included a 45 Second Electronic Anti-Skip Memory which makes this player virtually skip-free under normal circumstances.

There's a Dynamic Bass Boost Control that increases and enhances the bass response, and a set of stereo headphones with their own volume control. The headphones also fold to a compact size for easy carrying when not in use.

Please read this instruction manual completely and carefully to make sure you understand the proper operation of this product, and get the maximum enjoyment out of all the features of this state-of-the-art CD player.

Once again, thanks for purchasing this Emerson product.

The serial number of your CD player can be found on the bottom cabinet. We suggest that you record the serial number of your unit in the space below for future reference.

Model Number: **HD2850**

Serial Number: _____

IMPORTANT NOTES

**WARNING: TO PREVENT FIRE OR SHOCK HAZARD,
DO NOT EXPOSE THIS UNIT TO RAIN OR MOISTURE.**

Avoid installing the unit in locations described below:

- Places exposed to direct sunlight or lose to heat radiating appliances such as electric heaters.
- Dusty places.
- Places subject to constant vibration.
- Humid or moist places.

CLASS 1 LASER PRODUCT

CLASS 1 LASER PRODUCT
APPAREIL À LASER DE CLASSE 1
PRODUCTO LASER DE CLASE 1

CAUTION
INVISIBLE LASER RADIATION
WHEN OPEN AND INTERLOCKS
DEFEATED.
AVOID EXPOSURE TO BEAM



This product contains a low power Laser Device.

CAUTION

THIS LASER COMPACT DISC PLAYER FUNCTIONS BY HELP OF INVISIBLE LASER LIGHT AND IS EQUIPPED WITH SAFETY SWITCHES TO AVOID EXPOSURE WHEN DOOR IS OPEN AND SAFETY INTERLOCKS ARE DEFEATED. IT IS DANGEROUS TO DEFEAT OR BYPASS SAFETY SWITCHES.



DANGEROUS VOLTAGE

Uninsulated Dangerous Voltage, that may be of sufficient magnitude to constitute a risk of electric shock to persons is present within this product's enclosure.



ATTENTION

The Owner's Manual contains important operating and maintenance instructions.
For your safety, it is necessary to refer to the manual.

This device complies with part 15 of the FCC rules. Operation is subject to the condition that this device does not cause harmful interference.

LOCATION OF CONTROLS

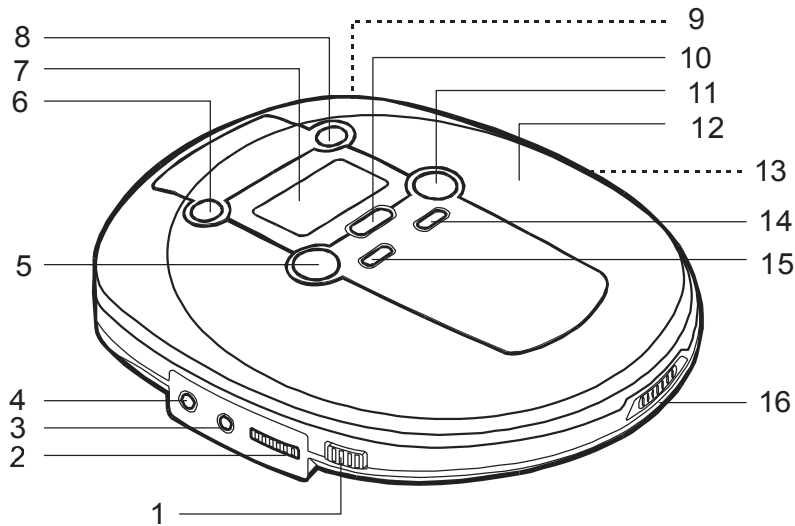

1. DBBS (Bass Boost) ON/OFF Switch - Switch On to increase bass response.
2. VOLUME Control – Raises or lowers the volume.
3. PHONES (Headphone) Jack – Connect stereo headphones, included, to this jack.
4. LINE OUT Jack – To connect this CD player to an external amplifier or recording device. Connection cable not included.
5. STOP ■ Button – To stop playback, and to turn the power ‘Off’.
6. PROG (Program) Button – To program tracks in the CD memory.
7. LCD Display – Shows track number, playing time, Anti-Skip memory status, Program, Repeat, Random, and Intro modes.
8. MODE Button – Selects the playback mode: Repeat 1/All, Random, or Intro.
9. DC Input Jack – Connect an AC adapter (not included) to this jack to use 120V 60 Hz house current.
10. ASP (Anti-Skip Protection) Button.
11. PLAY/PAUSE ►► Button – To begin playback, and to pause during playback.
12. CD Door.
13. Battery Compartment (on bottom cabinet).
14. SKIP FWD. ►►► Button – To skip tracks or search forward.
15. SKIP REV. ◄◄◄ Button – To skip tracks or search backward.
16. OPEN Switch – Slide to the right to unlock and open the CD door.

LCD DISPLAY INDICATORS

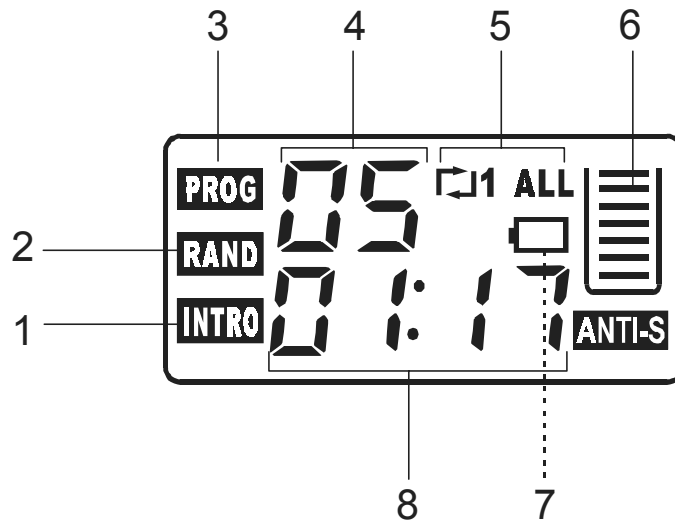

1. INTRO Indicator – Appears when Intro playback mode is selected.
2. RAND (Random) Indicator – Appears when Random playback mode is selected.
3. PROG (Program) Indicator – Appears when programming tracks or playing programmed tracks.
4. Track Number Display – Shows the track which is being played, and the total tracks on the disc.
5. Repeat 1/ALL Indicators – Appears when the Repeat playback mode is selected.
6. ANTI-S (Anti-Skip) Memory Indicator – Bar display indicates the remaining Anti-Skip memory capacity.
7. Battery Level Indicator – Blinks when batteries need to be replaced.
8. Time Display – Shows elapsed time of the track being played and total playing time of the disc.

POWER SOURCE

This CD player can be operated on either 120V 60Hz AC house current with an optional AC adapter (not included) or on 3V DC (2 "AA" batteries, not included).

BATTERY OPERATION

1. Open the battery compartment door on the bottom cabinet by sliding it in the direction of the arrow and then lifting it open. To prevent loss, the door cannot be removed from the unit.
2. Insert 2 "AA" batteries (not included) into the compartment. Use alkaline batteries for longest life. Follow the polarity markings inside the compartment. If the batteries are inserted incorrectly the unit will not work.

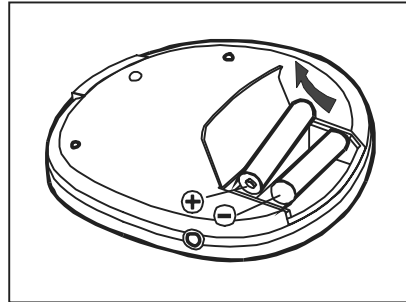

NOTE:

In order to operate the player on batteries the AC adapter must be disconnected from the DC IN jack.

BATTERY REPLACEMENT

When the batteries become too weak the battery level indicator begins to flash and operation may become erratic. When this occurs replace the batteries immediately.

BATTERY PRECAUTIONS

Follow these precautions when using batteries in this device:

1. Use only the size and type of batteries specified.
2. Be sure to follow the correct polarity when installing the batteries as indicated in the battery compartment. Reversed batteries may cause damage to the device.
3. Do not mix different types of batteries together (e.g. Alkaline and Carbon-Zinc) or old batteries with fresh ones.
4. If the device is not to be used for a long period of time, remove the batteries to prevent damage or injury from possible battery leakage.
5. Do not try to recharge batteries not intended to be recharged; they can overheat and rupture (Follow battery manufacturer's directions.)

AC OPERATION (Adapter not included)

Connect the AC adapter to your 120V AC outlet. Then connect the small plug to the "DC IN 4.5V" jack on the back of the player as shown in the following illustration.

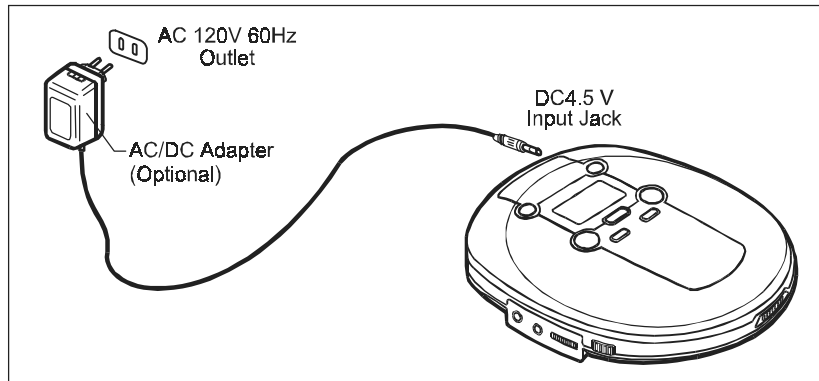

NOTE:

This optional AC adapter, should be rated as follows:

Input: 120V/ 60Hz AC

Output: 4.5V DC

The adapter must have a female-type plug with a positive center:



- Be sure the adapter is UL listed. If you use a "Universal"-type adapter, be sure to set the output selector to "DC 4.5V".
- If the AC adapter will not be used for an extended period of time, remove it from the wall outlet by pulling on the adapter housing. Do not remove the adapter by pulling on the cord. Do not touch the AC adapter with wet hands.

OPERATING INSTRUCTIONS

NORMAL PLAYBACK

1. Connect the headphones to the PHONES jack.
Set the VOLUME control to a low level before you begin playback and then adjust the volume to a comfortable level after playback begins.
2. Slide the CD Door OPEN switch to the right to release the lock and open the CD Door.
3. Place your disc on the center spindle with the printed label side facing up. Press down gently near the center hole to make sure the disc is properly seated on the spindle.
4. Close the door completely until it locks shut.
5. Press the PLAY/PAUSE ►|| button. "45 sec" followed by "00" appear in the display as the player reads the disc, then playback begins on Track 1. The Anti-Skip indicator comes on and the playing time shows in the display.
6. Adjust the VOLUME and DBBS (Bass Boost) controls as desired.
NOTE: We have included a second volume control on the headphone cable. This allows you to easily adjust the volume if you are carrying the main unit in a pocket, handbag, backpack etc.
7. When all tracks have been played the player stops and the display shows the total tracks and playing time on the disc. After approximately 1 minute the power shuts off and the display goes blank.
To stop playback before the disc ends press the STOP ■ button at any time. Press the STOP ■ button again to shut the power off immediately.
8. Slide the CD Door OPEN switch to the right to open the door and remove your disc. Close the CD Door and return your disc to its protective storage case.

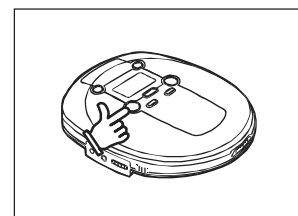
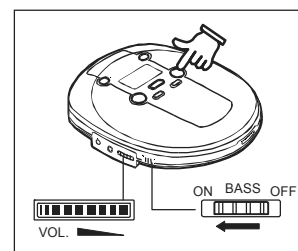
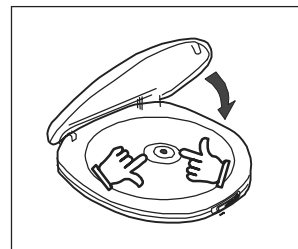
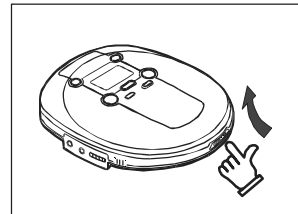
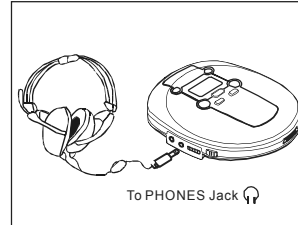

PAUSE CONTROL

Press the PLAY/PAUSE ►|| button during playback to pause momentarily. The sound stops, the track and the time display flashes but the disc continues to spin. Press the PLAY/PAUSE ►|| button again to cancel pause and resume playback. The sound returns and the display stops flashing.

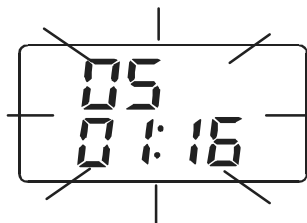

SKIP/SEARCH CONTROLS

To skip forward or backward to another track during playback press the SKIP FWD ►► or SKIP REV ◄◄ buttons repeatedly until the desired track number appears in the display. Playback will begin on the desired track.

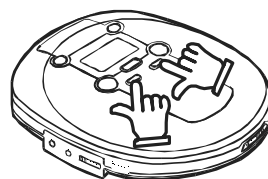

To search forward or backward within a track to locate a specific musical passage press and hold either the SKIP FWD ►► or SKIP REV ◄◄ buttons. The player moves forward or backward at high speed. When you reach the desired point in the track, release the buttons and normal playback resumes.

REPEAT PLAYBACK

To repeat a single track:

1. Press PLAY/PAUSE ►|| button to begin playback.
2. When playback begins press SKIP FWD ►► or SKIP REV ◄◄ button to select the desired track.
3. Press the MODE button once until the Repeat 1 “◀▶ 1” indicator appears in the display. The selected track will be repeated indefinitely.

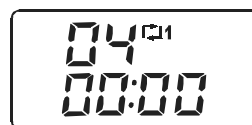
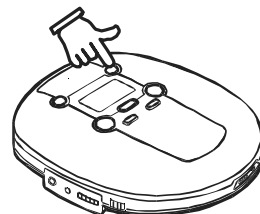

To repeat the entire disc:

1. Press PLAY/PAUSE ►|| button to begin playback.
2. When playback begins press the MODE button twice until the Repeat All “◀▶ ALL” indicator appears in the display. The entire disc will be repeated indefinitely.



To cancel repeat playback:

1. Press the STOP ■ button, or;
2. Press the MODE button until no special mode indicators appear in the display.



INTRO SCAN

This feature plays only the first 10 seconds of each track on the disc.

1. Press PLAY/PAUSE  button to begin playback.

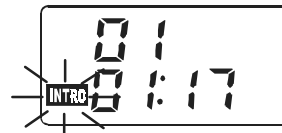
2. When playback begins press the MODE button 3 times. The "INTRO" indicator flashes in the display.



3. Press the STOP  button to stop the disc and then press the PLAY/PAUSE  button again. The "INTRO" indicator stops flashing and remains 'On'. The player returns to the beginning of track 1 and plays just the first 10 seconds of each track on the disc. When the first 10 seconds of each track has been played, the player stops.



To cancel Intro Scan press the STOP  button or press the MODE button until none of the special playback mode indicators appear in the display.



RANDOM PLAYBACK

Use Random playback to play all the tracks on a disc in a random order selected by the CD player.

1. Press PLAY/PAUSE  button to begin playback.

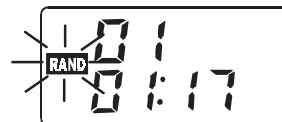
2. When playback begins press the MODE button 4 times until the "RAND" indicator flashes in the display.



3. Press the STOP  button to stop the disc and then press the PLAY/PAUSE  button again. The "RAND" indicator stop flashing and remains on. The player randomly selects the first track for playback and continues randomly selecting tracks until every track on the disc has been played once. After all tracks have been played the player stops.

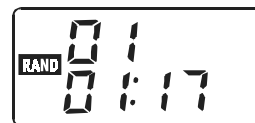

To cancel Random playback, press the STOP  button, or press the MODE button until no special mode indicators remain in the display.



PROGRAMMED PLAYBACK

You can program the player to play only the tracks that you want to hear, in the specific order that you want to hear them. Up to a total of 24 tracks can be programmed. You may program certain tracks to play more than once if desired.

IMPORTANT: The player can only be programmed when it is in the Stop mode and the total number of tracks and playing time appear on the display. If the display is blank press the PLAY/PAUSE ►► button to start the disc. When playback begins press the STOP ■ button. If the disc was playing, press the STOP ■ button so that the total tracks and playing time appear on the display.

1. While the total tracks and playing time appear on the display press the PROG (Program) button. "PROG" indicator flashes and Program No. "P - 01" appears.



2. Press SKIP FWD ►► or SKIP REV ◀◀ button until the first track to be programmed appears in the display. Example: Track # 7.

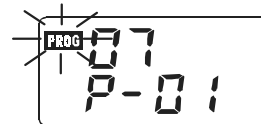

3. Press the PROG (Program) button again to enter the selected track in the memory. The track indicator returns to a "00" and the Program No. advances to "P - 02".

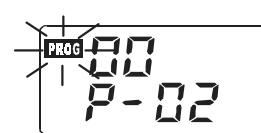

4. Repeat Steps 2 and 3 until you have entered up to a total of 24 tracks in the memory.

5. Press the PLAY/PAUSE ►► button to begin programmed playback. The "PROG" indicator stops flashing and remains in the display. The player will play the tracks you selected in the programmed order. When the last track has played the player stops and the total tracks and playing time appear.

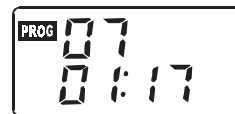







6. To cancel programmed playback press the STOP ■ button twice. The program will also be canceled if the CD Door is opened or if the power is interrupted.



ELECTRONIC ANTI-SKIP PROTECTION

This CD player is equipped with an automatic 45 second Electronic Anti-Skip Memory and an Anti-Rolling Mechanism that will eliminate virtually all skipping under normal conditions. When you press the PLAY/PAUSE **▶||** button to begin playback the player immediately begins to store 45 seconds of music in a solid state memory that is impervious to shock. The player is always reading the disc 45 seconds ahead of the music you are hearing and storing that information in the memory. If the player is subjected to shock or bumps of less than 45 seconds duration you will not notice them at all. If the bumps last longer than 45 seconds the anti-skip memory may be depleted and the player may skip or stop.

When playback begins the Anti-Skip indicator  comes on and a series of "bars"  appear in the display. When all 5 "bars"  appear the Anti-Skip memory contains 45 seconds of music and is "full". If the player is bumped or shaken the "bars" may start to disappear  as the memory is depleted. If all 5 "bars" disappear  the memory is empty and the player may skip if the bumps continue.

When the bumps stop the memory starts to fill up again and all 5 "bars"  will reappear.

CONNECTION TO AN EXTERNAL AUDIO SYSTEM

You can connect this CD player to a home stereo system, receiver, amplifier, or recorder if desired. Connect the LINE OUT jack of this CD player to the Left/Right Auxiliary Inputs, Line Inputs, or Record Inputs of the external device. The connection cable is NOT included. Set the DBBS(Bass Boost) switch of this CD player to the 'OFF' position. Be sure to follow the external source connection instructions for the other equipment as well.

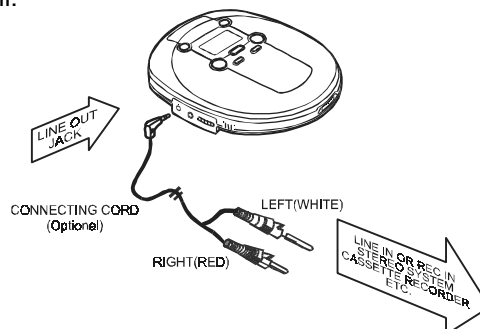

CARE AND MAINTENANCE

CLEANING THE CABINET

Wipe with a soft cloth. If the cabinet is very dirty, dampen the cloth with a weak solution of neutral detergent and water, and then wipe clean.

CLEANING THE LENS

A dirty lens will cause sound skipping and, if the lens is very dirty, the CD may not work. Open the disc cover and clean the lens as follows:

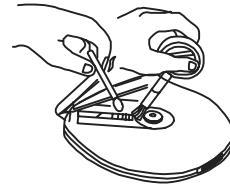

DUST OR DRY PARTICLES

Using a camera lens brush/blower, blow on the lens several times, then wipe it lightly with the brush to remove dust. Then, blow on the lens once more.

FINGERPRINTS

To remove fingerprints from the lens, use a cotton swab starting in the middle and working to the outside edge. Use only very light pressure on the lens to avoid forcing it out of alignment.

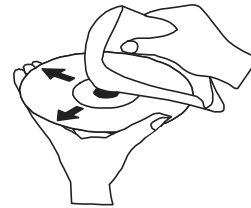

CLEANING THE DISC

When a disc becomes dirty, clean it with a cleaning cloth. Wipe the disc from the center out.

NOTE:

Do not use solvents such as benzene, thinner; commercially available cleaners or anti-static spray intended for analog discs.

TROUBLESHOOTING GUIDE

If you experience a problem with this unit, check the chart below before calling for service.

SYMPTOM	CAUSE	SOLUTION
Unit will not turn on.	Weak or dead batteries.	Replace batteries.
	CD compartment not closed.	Close CD compartment.
Disc will not play.	Disc inserted incorrectly.	Reinsert disc correctly.
	Dirty or defective disc.	Try another disc.
	Moisture or condensation on disc or lens.	Disc: wipe with soft cloth. Lens: see page 12 'Care and Maintenance'
No sound from headphones.	Headphone plug not inserted correctly.	Reinsert headphone plug correctly.
	VOLUME controls set to minimum.	Raise volume controls on main unit and/or headphone cable.
	Weak batteries.	Replace batteries.
	Defective disc.	Try another disc.
Erratic playback.	Dirty or defective disc.	Clean or replace disc.



Emerson®

SERVICE

FOR ADDITIONAL SET-UP OR OPERATING ASSISTANCE
PLEASE CALL:
1-800-898-9020

FOR CUSTOMER SERVICE, PLEASE WRITE TO:
Emerson Radio Corp.
Consumer Affairs Dept.
1901 Diplomat Drive,
Farmers Branch, TX 75234.



**EMERSON RADIO CORP.
LIMITED WARRANTY**

What does this warranty cover ? Any manufacturing defects in original material, including original parts and workmanship, under normal use and conditions.

For how long? For a period of ninety (90) days from the date of original purchase in the U.S.

What will we do ? If you need service under this Warranty, and you provide us with the dated proof of purchase, we will provide repair service at no charge for labor and parts at an authorized Depot Repair Facility, or replace the product in our discretion.

How do you make your warranty claim ? If it becomes necessary to repair your unit, you can obtain the name and mailing location of a Depot Repair Facility by dialing **1-800-695-0098**. You should pack your unit in a well-padded heavy corrugated box, enclose your check or money order payable to the Depot Repair Facility in the amount of **\$9.00** to cover the return shipping and handling costs, and enclose a copy of your proof of purchase (warranty service will not be provided without a dated proof of purchase). Finally, you should ship the unit prepaid via UPS or parcel post (insured).

What does your warranty not cover ? Your warranty does not cover the following :

- Damage from negligence, misuse, abuse, accident, or failure to follow operating instructions.
- Use of product in a commercial application or rentals.
- Changes or repairs by anyone other than an authorized Depot Repair Facility.
- Damage because your unit is improperly connected to the equipment of other manufacturers.
- Unit on which the serial number has been defaced, modified or removed.
- Damage to equipment not properly connected to the product.
- Cost incurred in shipping your unit to and from an authorized Depot Repair Facility.
- Ordinary adjustments which you can perform as outlined in the owner's manual.
- Signal reception problems caused by external antenna or cable systems.
- Products purchased, used, serviced, or damaged outside of the United States.
- Damage to compact discs or cassettes.

What other limitations apply to your warranty ?

THIS WARRANTY IS NON-TRANSFERABLE AND APPLIES ONLY TO THE ORIGINAL PURCHASER AND DOES NOT EXTEND TO SUBSEQUENT OWNERS OF THE PRODUCT. THIS WARRANTY IS VALID ONLY IN THE UNITED STATES OF AMERICA. ANY APPLICABLE IMPLIED WARRANTIES, INCLUDING THE WARRANTY OF MERCHANTABILITY, ARE LIMITED IN DURATION TO A PERIOD OF THE EXPRESSED WARRANTY AS PROVIDED ABOVE BEGINNING WITH THE DATE OF ORIGINAL PURCHASE AT RETAIL AND NO WARRANTIES, WHETHER EXPRESSED OR IMPLIED, SHALL APPLY TO THE PRODUCT THEREAFTER. WE MAKE NO WARRANTY AS TO THE FITNESS OF THE PRODUCT FOR ANY PARTICULAR PURPOSE OR USE.

THE EXTENT OF OUR LIABILITY UNDER THIS LIMITED WARRANTY IS THE REPAIR OR REPLACEMENT PROVIDED ABOVE AND IN NO EVENT WILL OUR LIABILITY EXCEED THE PURCHASE PRICE PAID BY THE PURCHASER OF THE PRODUCT. UNDER NO CIRCUMSTANCES WILL WE BE LIABLE FOR ANY LOSS, DIRECT, INDIRECT, INCIDENTAL, SPECIAL, OR CONSEQUENTIAL DAMAGE ARISING OUT OF OR IN CONNECTION WITH THE USE OF THIS PRODUCT.

How does state law apply to your warranty ?

THIS WARRANTY GIVES YOU SPECIFIC LEGAL RIGHTS, BUT YOU MAY ALSO HAVE OTHER RIGHTS WHICH VARY FROM STATE TO STATE. SOME STATES DO NOT ALLOW LIMITATIONS ON IMPLIED WARRANTIES OR EXCLUSION OR LIMITATION OF INCIDENTAL OR CONSEQUENTIAL DAMAGE, SO THESE RESTRICTIONS MAY NOT APPLY TO YOU.

AU898F



EMERSON RADIO CORP.



EMERSON
PART NO. : 16-2832
108-01
800.898.9020

PRINTED IN CHINA

