

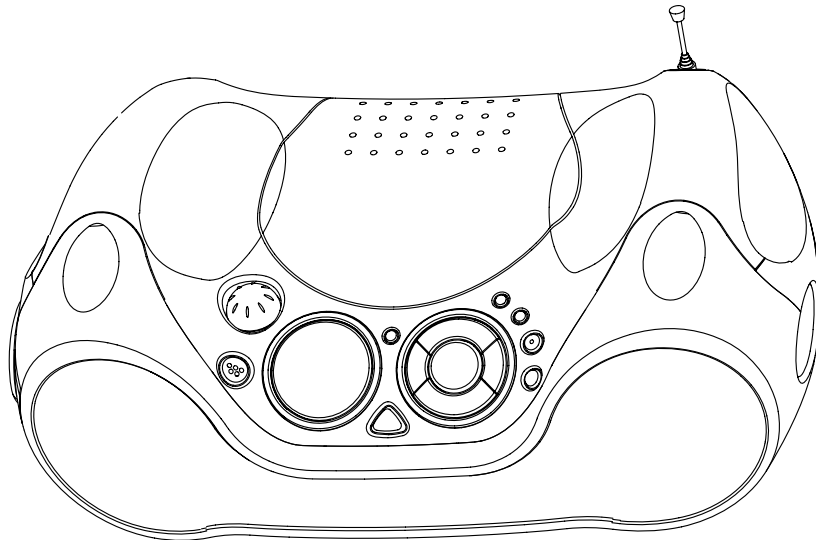

MODEL NO. RCD672

PORTABLE CD PLAYER WITH RADIO

OWNER'S MANUAL



PLEASE READ BEFORE OPERATING THIS EQUIPEMNT

	CAUTION RISK OF ELECTRIC SHOCK DO NOT OPEN	
CAUTION: TO REDUCE THE RISK OF ELECTRIC SHOCK, DO NOT REMOVE COVER (OR BACK). NO USER-SERVICEABLE PARTS INSIDE. REFER SERVICING TO QUALIFIED SERVICE PERSONNEL.		



DANGEROUS VOLTAGE

The lightning flash with arrowhead symbol, within an equilateral triangle is intended to alert the user to the presence of uninsulated dangerous voltage within the product's enclosure that may be of sufficient magnitude to constitute a risk of electric shock to persons.



ATTENTION

The exclamation point within an equilateral triangle is intended to alert the user to the presence of important operating and maintenance (servicing) instructions in the literature accompanying the appliance.



DANGER:

Invisible and hazardous laser radiation when open and interlock failed or defeated. Avoid direct exposure to beam.

LASER SAFETY: This unit employs a laser. Only qualified service personnel should attempt to service this device due to possible injury.
CAUTION: USE OF CONTROLS, ADJUSTMENTS OR PERFORMANCE HEREIN MAY RESULT IN HAZARDOUS RADIATION EXPOSURE.

PREPARATION FOR USE

Unpacking and Setup

- Carefully remove the unit from the display carton and remove all packing material from the unit itself.
- The detachable AC power cord is packed in the carton separately from the unit. Make sure the AC power cord is not accidentally discarded with the carton or packing material.
- Press the CD Door OPEN/CLOSE area to open the CD compartment door. There is a white card in the CD compartment which intended to prevent the CD pickup from moving during shipment of the product. Remove this card from the CD compartment before use.

Power Sources

This portable audio system is designed to operate on AC 120V~60Hz or by using eight (8) "C" batteries, (batteries not included). Attempting to operate this unit from any other power source may cause damage to the unit, which is not covered by your warranty.

AC Operation

Unwind the AC cord and extend it to its full length. Insert the small end of the AC cord into the AC power socket on the rear of the unit. Insert the other end of the AC cord into any convenient AC 120V~60Hz household outlet.

Battery Installation

To use this unit with battery power, remove the battery compartment on the bottom of the unit by sliding it towards the rear of the unit and lifting the battery door off. Insert eight (8) "C" size batteries (batteries not included) following the diagram in the compartment.

NOTE: The power cord must be disconnected from the AC power socket on the rear of the unit in order for the unit to operate on battery power.

LOCATION OF CONTROLS

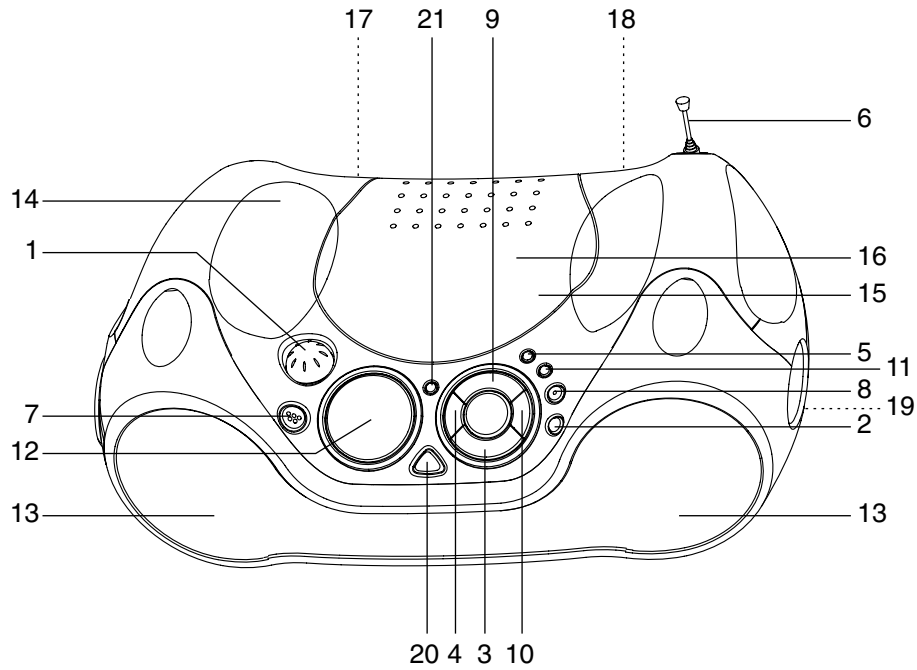

- | | |
|---------------------------------------|---|
| 1. VOLUME CONTROL | 12. DISPLAY WITH BACK LIGHT |
| 2. ALBUM BUTTON | 13. SPEAKER |
| 3. STOP BUTTON | 14. CARRYING HANDLE |
| 4. SKIP / TUNER DOWN BUTTON | 15. CD DOOR OPEN / CLOSE |
| 5. MEMORY / CLOCK SET BUTTON | 16. CD COMPARTMENT |
| 6. FM ROD ANTENNA | 17. BATTERY COMPARTMENT
(BOTTOM OF UNIT) |
| 7. POWER BUTTON | 18. AC POWER SOCKET
(REAR OF UNIT) |
| 8. FUNCTION BUTTON | 19. PHONE JACK (SIDE OF UNIT) |
| 9. PLAY / PAUSE / MEMORY UP
BUTTON | 20. BASS BOOST BUTTON |
| 10. SKIP / TUNER UP BUTTON | 21. BAND BUTTON |
| 11. P-MODE / MEMORY DOWN BUTTON | |

OPERATING INSTRUCTIONS

SETTING THE CLOCK

1. With the power off, press and hold the MEMORY/CLOCK button; "12H" will blink.
2. Press the REW SKIP TUNER-DN or FEW. SKIP/TUNER-UP button to set the unit to the 24 hour (24H) mode (also known as military time), or 12 hour (12H) mode.
3. Press the MEMORY/CLOCK SET button and the hours will blink.
4. Press the REW SKIP TUNER-DN or FEW. SKIP/TUNER-UP button to set the current hour, then press the MEMORY/CLOCK SET button again; the minute digits will blink.
5. Press the REW SKIP TUNER-DN or FEW. SKIP/TUNER-UP button to set the current minute, then press the MEMORY/CLOCK SET.

LINE IN Jack (FRONT OF UNIT)

By using a home audio connection cable (not included), you can listen to an external audio unit through this unit's speakers. Before making any connections, turn off the power to all equipment.

Plug a connection cable (not included) between the LINE OUT jack on the external audio unit and this unit's LINE IN jack. (Do not connect it to this unit's PHONES jack.)

OPERATING INSTRUCTIONS

PLAYING COMPACT DISCS

1. Press the POWER button to turn the unit on.
2. Open the CD compartment lid by pressing the CD Door OPEN/CLOSE area.
3. Insert a disc, label side up, into the compartment. Press the CD Door OPEN/CLOSE area to close the CD compartment lid; the total tracks will appear in the display.
4. Press the PLAY/PAUSE button to begin playback; the current track will appear in the display.
5. When the disc is through playing, it will stop. Press the STOP button to stop the disc before it is finished.
6. Press the POWER button to turn the CD off.

NOTES:



- If a disc is inserted incorrectly, dirty, damaged or not present at all, "no" will appear in the display.
- As each track is playback, the track number is shown in the display
- To prevent damage to the disc, never open the CD door while the disc is rotating. Wait for the disc to stop before opening the CD door. Never touch the lens when the CD compartment door is open.
- DO NOT use the carrying handle when playing a CD. The CD should only be used on a steady surface.
- This unit will play 3" CD singles, no adapter is needed.
- The maximum playing time is 74 minutes.

CD PAUSE CONTROL

1. During CD playback, if you wish to pause the disc momentarily, press the PLAY/PAUSE button. Playback stops but the disc continues to spin and the playback symbol blinks in the display.
2. Press the PLAY/PAUSE button again to release pause and resume normal CD playback.

OPERATING INSTRUCTIONS

TO REPEATEDLY PLAY BACK ONE TRACK/ALL TRACKS

1. To repeat a single track, press the P-MODE/M-DN button once while in the Stop mode;  will show in the display. Press the REW SKIP TUNER-DN or FEW. SKIP/TUNER-UP button to select the specific track that you wish to repeat. When the desired track number appears in the display, press the PLAY/PAUSE button to begin playback. The specific track you selected will be repeated continuously.
2. To repeat all of the tracks on a disc continuously, press the P-MODE/M-DN button twice while in the Stop mode; ALL  will show in the display. Press the PLAY/PAUSE button to begin playback; all the tracks on the CD will repeat continuously.
3. To cancel Repeat Playback, press the P-MODE/M-DN button until the Repeat indicator disappears from the display or press the STOP button.

RANDOM PLAY BACK CD

1. Press P-MODE/M-DN button three times while in STOP MODE; "RAND" will show in the display. Press PLAY/PAUSE button to begin RANDOM play.
2. To cancel RANDOM play, press the P-MODE/M-DN button until RANDOM indicator disappears from the display.

PROGRAMMED PLAYBACK

The CD player in this unit has a 20 track programmable memory that allows you to program up to 20 tracks on any disc for playback in any desired order. You may program 20 different tracks or you may also program certain tracks to play more than once.

To perform programmed playback, proceed as follows:

1. Press the POWER button to turn the unit on.
2. Open the CD compartment lid by pressing the CD Door OPEN/CLOSE area and insert your disc in the CD player with label side up. Close the CD compartment door.
3. At STOP MODE, press the MEM/PROG CLK SET button; "P-01" (Program Number) will show in the display and flash.

OPERATING INSTRUCTIONS

4. Press the REW SKIP TUNER-DN or FEW. SKIP/TUNER-UP button to select the track number (Example: Track 5) appears in the display, press the MEMORY/CLOCK SET button. "P-02" indicating program 2 is ready to be set. Then press the REW SKIP TUNER-DN or FEW. SKIP/TUNER-UP button repeatedly to select a second track, press the MEMORY/CLOCK SET button again.
5. After programming up to 20 tracks in the CD program Memory, press the PLAY/PAUSE button to begin programmed playback; "PROG" will appear in the display and playback will begin on the first track that you programmed. The player will continue to play all of the tracks that you programmed in the order in which you programmed them.

When the last programmed track has been played, the player will stop. To begin the programmed playback again, press the PLAY/PAUSE button to begin programmed playback again. To cancel the Programmed Playback mode, press the POWER button or OPEN the CD door.

NOTES ON PROGRAMMED PLAYBACK:

- Press the STOP/BAND button to stop the program before it is finished.
- You can skip through the program while it is playing using the REW SKIP TUNER-DN or FEW. SKIP/TUNER-UP button.

LISTENING TO THE RADIO

1. Press the POWER button to turn the unit on.
2. Press the Function button to select the Tuner mode. Press the STOP/BAND button to select AM or FM.
3. Use the REW SKIP TUNER-DN or FEW. SKIP/TUNER-UP button to select the desired AM or FM station. When a strong FM Stereo signal is received, the (ST) symbol will show in the display.
4. If you press and hold the REW SKIP/TUNER-DN or TUNER-UP button for one second, then release, the unit will automatically scan to the next broadcasting station.
5. Press the POWER button to turn the radio off.

OPERATING INSTRUCTIONS

HINTS FOR BETTER RECEPTION

FM - Make sure that the telescopic FM Rod Antenna is raised and extended to its full length. You may have to vary the direction of the antenna to find the strongest signal for each FM station.

AM - The AM ferrite bar antenna is located inside the cabinet. It may be necessary to turn the unit slightly so that the internal antenna is pointing in the direction of the AM transmitter. You may have to experiment to find the position that provides the strongest reception for each your favorite AM section.

TO SET/RECALL THE RADIO PRESETS (20 FM/AM)

1. Press the POWER button to turn the unit on. Press the Function button to select the Tuner mode.
2. Press the STOP/BAND button to select AM or FM. Use the REW SKIP TUNER DN or TUNER UP button to select the desired AM or FM station.
3. Press the MEMORY/CLOCK SET button; "P-01" will blink in the display.
4. Press the MEMORY/CLOCK SET button again to set the preset. Repeat steps 2 through 4 to set more presets.
5. The unit can preset 20 station totally for AM and FM.
6. When "P01-P20" is blinking, press REW SKIP TUNER-DN or FEW. SKIP/TUNER-UP button to select the Preset number.
7. Press M-UP or M-DN to select your preset station.

OPERATING INSTRUCTIONS

PROGRAMMED REPEAT

1. It is also possible to use the Program and Repeat functions together to repeat a specific program indefinitely. First, program the tracks you wish to hear in the order you wish to hear them, as described on the previous page. Then, press the PLAY/PAUSE button to begin program playback.
2. Press the P-MODE/M-DN button twice; both indicators  ALL will appear in the display. The player will play the tracks you selected in the order in which you programmed them. When the last track in the program has been played, the entire program will begin again.
3. Programmed Repeat operation will continue indefinitely until you press the STOP button, or turn the unit off.

PLAYING MP3 DISCS

1. Press the POWER button to turn the unit on and press the function button to CD mode.
2. Open the door. Insert an MP3-encoded CD label side up. Close the CD door.
3. Press the PLAY/PAUSE Button. All the of the tracks will be played once.

MP3 SKIP/SEARCH

- Press the REW SKIP TUNER-DN or FEW.SKIP/TUNER-UP button to select a particular track.
- Press and hold REW SKIP TUNER-DN or FEW.SKIP/TUNER-UP button to quickly advance through music.
- Press ALBUM button once to select the current folder. Press ALBUM button twice to select folder. When playing MP3 disc, press REW SKIP TUNER-DN or FEW.SKIP/TUNER-UP button to select another track. Press ALBUM button to indicate the current folder and press again to select the other folder.

OPERATING INSTRUCTIONS

MP3 REPEAT ONE PLAY

To repeat a single track, press the P-MODE/M-DN button while the track you want to repeat is playing. The repeat indicator "↺↻" will appear in the LCD.

To repeat another track, press REW SKIP or FWD SKIP button.

- To cancel Repeat Single Track, press the P-MODE/M-DN button five times.

MP3 REPEAT ALL PLAY

To repeat all tracks, press the P-MODE/M-DN button three times during play. The "↺↻ ALL" indicator will appear in the LCD.

- All tracks will be repeated continuously.
- To cancel Repeat All Tracks, press the P-MODE/M-DN button twice.

MP3 REPEAT ALBUM PLAY

If you have placed your MP3s into a folder structure before recording an MP3-encoded CD, you can repeat a directory (ALBUM)

1. To repeat an entire directory (album), press the P-MODE/M-DN button twice times. The "REPEAT" album indicator will appear in the LCD.
2. Press the ALBUM button repeatedly to select the desired album.
3. Press Play button to Play the select album.
4. To cancel repeat album press the P-MODE/M-DN button three times.

OPERATING INSTRUCTIONS

MP3 PROGRAM PLAY

You can program up to 10 tracks to play in any order you choose.

1. During the Stop mode, press the MEM/CLK SET button to enter the Program mode. The "PROG" indicator and memory location (P-01, P-02....P-10) will appear in the LCD display and the directory will flash.
 2. Press the ALBUM button continue to select ALBUM.
 3. Press the SKIP UP or DOWN button to choose track.
 4. Press the MEMORY Button to set the program indicator will flash.
 5. Repeat Steps 2-4 to program additional tracks up to total 10 tracks.
 6. Press the PLAY/PAUSE Button to play the programmed tracks.
- Press the STOP Button to stop Program Play.

CARE AND MAINTENANCE

Caring for Compact Discs

- Treat the compact disc carefully. Handle the compact disc only by its edges. Never allow your fingers to come in contact with the shiny, unprinted side of the compact disc.
- Do not attach adhesive tape, stickers, etc. to the compact disc label.
- Clean the compact disc periodically with a soft, lint-free, dry cloth. Never use detergents or abrasive cleaners to clean the compact disc. If necessary, use a CD cleaning kit.
- If a compact disc skips or gets stuck on a section of the compact disc, it is probably dirty or damaged (scratched).
- When cleaning the compact disc, wipe in straight lines from the center of the compact disc to the outer edge of the compact disc. Never wipe in circular motions.

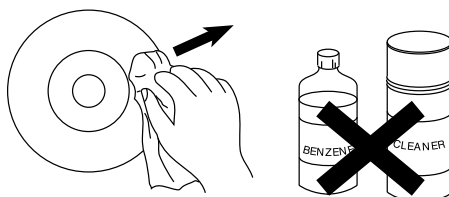
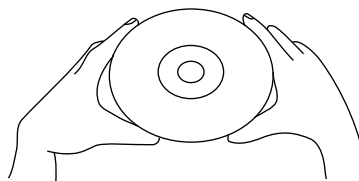

- This unit is designed to play only compact discs bearing the identification logo as shown here. Other discs may not conform to the CD standard and may not play properly.
- Compact Discs should be stored in their cases after each use to avoid damage.
- Do not expose compact discs to direct sunlight, high humidity, high temperatures or dust, etc. Prolonged exposure or extreme temperatures can warp the compact disc.
- Do not stick or write anything on either side of the compact disc. Sharp writing instruments, or the ink, may damage the surface.



Cleaning the Unit

- To prevent fire or shock hazard, disconnect your unit from the AC power source when cleaning.
- The finish on your unit may be cleaned with a dust cloth and cared for as other furniture. Use caution when cleaning and wiping the plastic parts.
- Mild soap and a damp cloth may be used on the front panel.

TROUBLESHOOTING GUIDE

Should this unit exhibit a problem, check the following before seeking service:

Symptom	Possible Cause	Solution
Radio		
Noise or sound distorted on radio broadcasts.	Station not tuned properly for AM or FM.	Retune the AM or FM broadcast station.
	FM: Antenna Wire is not extended.	Extend FM Antenna Wire.
	AM: Unit is not positioned correctly.	Rotate unit until best reception is obtained.
AM or FM, no sound.	Volume at minimum.	Increase volume.
Compact Disc Player		
CD Player will not play.	CD is not installed or installed incorrectly.	Insert CD with label facing up.
CD skips while playing.	Disc is dirty or scratched.	Wipe disc with cloth or use another disc.
General		
No sound.	Power cord disconnected.	Connect power cord.
	No batteries, dead batteries or batteries not installed properly	Insert fresh batteries properly.
	Power is off.	Press the POWER button to the in position to turn the unit on.