



Model CD-102

Portable CD Player



User Manual



Thank you for purchasing the Califone® Model CD-102 Portable CD Player.

We encourage you to visit our website www.califone.com to register your product for its warranty coverage, to sign up to receive our newsletter, download our catalog, and learn more about the complete line of Califone audio visual products, including portable and installed wireless PA systems, multimedia players and recorders, headphones and headsets, computer peripheral equipment, visual presentation products and language learning materials.

IMPORTANT SAFETY INSTRUCTIONS

Before using this product, read the instruction manual for important safety information. Please retain this manual for future reference and warranty information.

Troubleshooting & Servicing

Do not attempt to service or repair the device yourself. Refer all servicing to qualified service personnel. Do not attempt to modify the device in any way. Doing so could invalidate your warranty.

Moisture and heat sources

Do not use this apparatus near water (for example, sinks, baths, pools) or expose it to rain, moisture, dripping or splashing liquids. Do not expose the unit to high temperatures, high humidity or direct sunlight.

Cleaning

When cleaning the device, please use a soft, dry cloth. Never use benzene, paint-thinner, or other chemicals on the device.

Location

Place the device in stable location, so it will not fall causing damage to the device or bodily harm.

Intended use

The product may only be used with the original parts intended for it. The product may only be used in closed and dry rooms. The intended use includes adherence to the specified installation instructions. The manufacturer accepts no liability for damage arising due to improper use.

IMPORTANT

This device complies with Part 15 of the FCC Rules. Operation is subject to the following two conditions:

(1) This device may not cause harmful interference, and (2) this device must accept any interference received, including interference that may cause undesired operation.

The CD circuitry may cause interference to nearby radios. To prevent interference, either switch the CD player off or move away from the affected radio.

NOTE: This equipment has been tested and found to comply within the limits for a class B digital device, pursuant to Part 15 of the FCC Rules.

These limits are designed to provide reasonable protection against harmful interference in a residential installation. This equipment generates, uses and can radiate radio frequency energy and, if not installed and used in accordance with the instructions, may cause harmful interference to radio communications. However, there is no guarantee that interference will not occur in a particular installation. If this equipment does cause harmful interference to radio or television reception, which can be determined by turning the equipment off and on, the user is encouraged to try to correct the interference by one or more of the following measures:

- Reorient or relocate the receiving antenna.
- Increase the separation between the equipment and receiver.
- Connect the equipment into an outlet on a circuit different from that to which the receiver is connected.
- Consult the dealer or an experienced radio / TV technician for help.

SAFETY CERTIFICATION

This Compact Disc Player is made and tested to meet safety standards of the FCC, requirements and compliance with safety performance of the U.S. Department of Health and Human Services, and also with FDA Radiation Performance Standards 21 CFR Subchapter J.



INVISIBLE LASER RADIATION WHEN OPEN AND INTERLOCK FAILED OR DEFECTED. AVOID DIRECT EXPOSURE TO LASER BEAM.

LASER SAFETY

This unit employs an optical laser beam system in the CD mechanism designed with built-in safeguards. Do not attempt to disassemble; refer to qualified service personnel. Exposure to this invisible laser light beam may be harmful to the human eye.

THIS IS A CLASS-1 LASER PRODUCT. USE OF CONTROLS, OR ADJUSTMENTS OR PROCEDURES OTHER THAN THOSE SPECIFIED HEREIN, MAY RESULT IN HAZARDOUS LASER LIGHT BEAM EXPOSURE.

PACKAGE CONTENTS

The following materials are included.

- CD-102 Portable CD Player
- Power Adapter
- 2 Alkaline AA batteries
- 3060AV Headphone
- User Manual

Unpacking the Unit

Inspect the unit once the packaging has been opened for any damage occurred during shipping & contact us immediately. Please keep the packing material for further use.

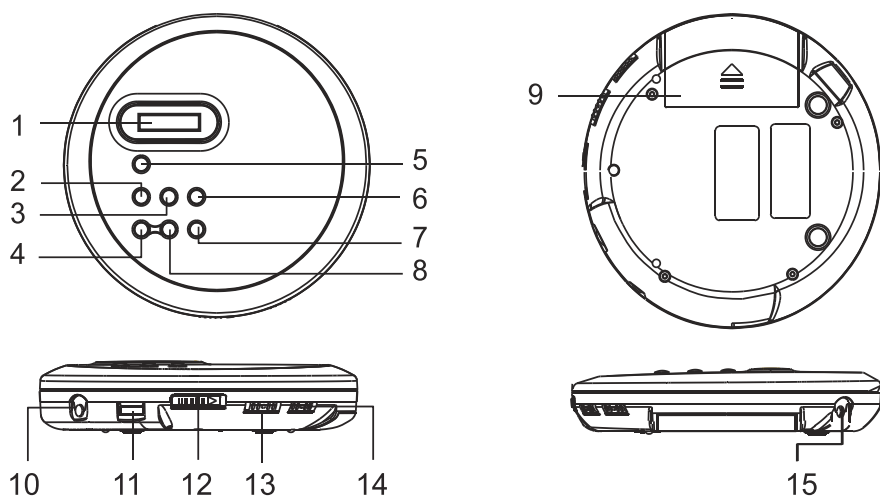

1. LCD Display
2. Program Button
3. Mode Button
4. CD Skip Backward Button
5. ANTI-SHOCK Button
6. CD Stop Button (Power Off)
7. CD Play/Pause Button (Power On)
8. CD Skip Forward Button

9. Battery Door
10. Earphone Jack
11. Volume Control
12. CD Door Open Switch
13. Bass Boost Switch
14. Hold Switch
15. DC Input Jack

SETUP AND INSTALLATION

BATTERY OPERATION

1. Open the battery compartment cover and insert two “AA” alkaline batteries inside the battery compartment. Follow the polarity as indicated in the battery compartment.
2. Close the battery compartment cover.

Caution:

- Do not attempt to recharge, short-circuit, disassemble, heat or throw the batteries into a fire.
- During store when batteries will not be used for an extended period of time. Be sure to remove them to avoid possible damage caused by battery leakage and corrosion.
- Do not mix alkaline, standard (carbon-zinc), or rechargeable batteries.
- Do not try to recharge batteries not intended to be recharged; they can overheat and rupture. (Follow the battery manufacturer's directions).
- Dispose of old batteries properly in accordance with local laws.

Low Battery

When the battery indicator appears in the LCD panel, this means that the batteries are losing their charge. In this case the CD player will not function properly and the batteries must be replaced.

AC OPERATION

1. Insert the DC plug, at the end of the AC adapter cord into the DC input jack.
2. Plug the AC adapter into AC power outlet socket. Use only with the 6V AC adapter and make sure the local voltage corresponds on the adapter's required AC input voltage.

Note: If the AC plug of this unit does not fit in your AC outlet, a plug adapter (not supplied) should be used. Consult your local dealer on the type of plug adapter required.

CONNECTING HEADPHONES

1. Decrease the volume to minimum.
2. Connect the earphones to the PHONES (GREEN) jack.
3. Increase the volume to the desired listening level.

Caution: Avoid excessive volume for long periods of time as this can result in hearing damage.

HANDLING COMPACT DISCS

This unit is designed to play only compact discs bearing the following identification logo.



Other discs may not conform to the CD standard and may not play properly.

- Dirty, scratched or warped discs may cause skipping or noise.
- Handle the disc only by the edges. To keep clean, do not touch its surface.
- Discs should be stored in their cases after use to avoid serious scratches.
- Do not expose disc to direct sunlight, high humidity, high temperature, dust, etc. Prolonged exposure to extreme temperatures can warp the disc.
- Do not stick or write anything on either side of disc. Sharp writing instruments or the inks used in some felttip pens may damage its surface

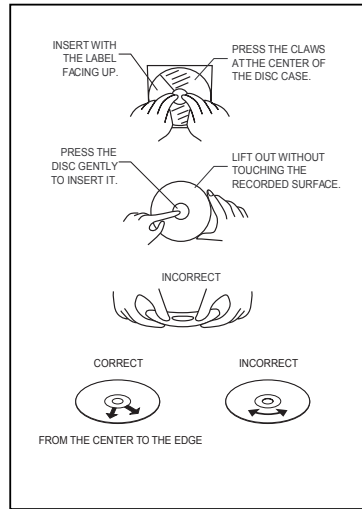

Remove the disc

- To pick up the disc, hold the edge and gently press the center pivot as illustrated.

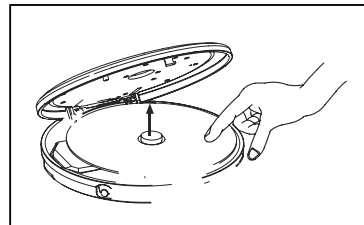

Caution:

Wait for the disc to stop rotating before pressing the OPEN button.

Note: This unit can play 3" (8cm) single CDs without an adapter. Do not use a CD single adapter for these discs.

CLEANING DISCS

Finger prints should be carefully wiped from the surface of disc with a soft cloth. Unlike conventional records, compact discs have no grooves to collect dust and microscopic debris, so gently wiping them with a soft cloth should remove most particles. Wipe in a straight motion from the center to the edge.

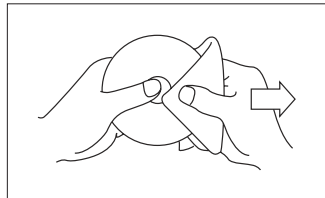

Never use thinner, benzene, record cleaner or anti-static spray on a compact disc. Such chemicals can damage its plastic surface.

MAINTENANCE

CLEANING THE CABINET

Wipe with a soft cloth. If the cabinet is very dirty, dampen the cloth with a weak solution of neutral detergent and water, and then wipe clean.

CLEANING THE LENS

A dirty lens will cause sound skipping and if the lens is very dirty, the CD may not work. Open the disc cover and clean the lens as below:

- *Dust or Dry Particles*
Using a camera lens brush/blower, blow on the lens several times and wipe it lightly with the brush to remove dust. Blow on the lens one more time.
- *Fingerprints*
If the lens cannot be cleaned by using a brush/blower, use a dry cotton swab starting from the middle and working to the outside edge.

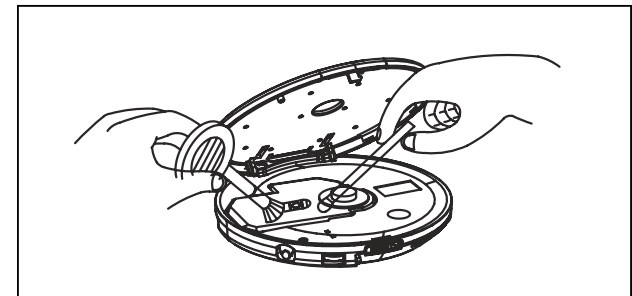

BASIC DISC PLAY

This CD-player can play Audio Discs such as CD-Recordables and CD-Rewritables.

DO not try to play a CD-ROM, CDi, VCD, DVD or computer CD.

1. Connect the earphones to the PHONES (GREEN) socket.
2. Press the OPEN button to open the CD compartment lid.
3. Adjust the VOLUME to minimum.
4. Insert the disc with the label side facing up.
5. Close the lid securely until a click is heard.
6. Press the PLAY button to start playing.

To Emphasize the bass sound

Set the BASS BOOST switch to the ON position.

Note: The bass boost performance will depend on the VOLUME control setting.



HOLD Switch

This switch prevents accidental selection of an unwanted function during Playback or Stop mode. In the HOLD "ON" position, no function button on the unit can be operated (except OPEN). Moving the switch to the "OFF" position will allow the unit to return to normal operation.

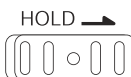

Turning Power on and off

This unit has no ON/OFF switch. To turn on and off, press the following buttons.

To turn on: Press >|| PLAY/PAUSE (playback starts).

To turn off: Press ■ STOP button once for standby mode.

Press ■ STOP button twice to turn off the power.

Auto power-off function

When the unit is stopped (standby mode) for approximately 30 seconds, the power will automatically turn off.

LCD DISPLAY INFORMATION

WHEN POWER IS ON

If a disc is in, auto adjustment starts. During adjustment, display shows - -.

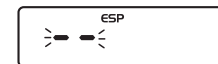

- If no disc is in, disc is displayed. Put the disc in and close the lid. Auto adjustment starts.



- If the lid is open, display shows OPEN. Closing the lid starts auto adjustment.



- If unable to read TOC then Er is displayed. Note: TOC means Table Of Contents.



- When TOC data has been read, display shows TOC for 1 second.



- To turn on anti-shock press ANTI-SHOCK key play, ANTI-SHOCK will start. To turn anti-shock off press ANTI-SHOCK key again, the will disappear on the display.



TO PLAY FROM STOP CONDITION

- Press the PLAY/PAUSE button. The display changes to 01 00:00 and starts play.



- When the memory is full, stops flashing.



TO STOP

Press the STOP button. This will stop play and the TOC will be displayed.



TO PAUSE

Press the PLAY/PAUSE button and the pause on/off button alternately. When the unit is paused, the time display will flash.



REPEAT/PLAY MODES

Every time the MODE button is pressed, the corresponding mode appears in the display window.

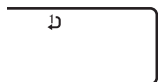
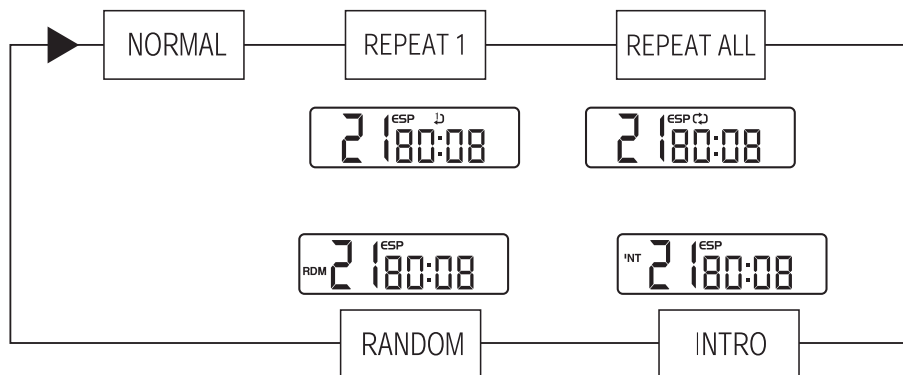

Shown on the LCD display. The current track on the disc will be repeated.

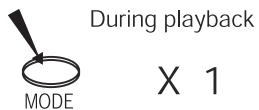

During playback

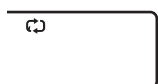

Shown on the LCD display. All tracks on the disc will be repeated.



During playback

NOTE: In normal mode, none of the above mode symbols will be shown in the display.

NORMAL PLAYBACK

During normal playback a  indicator appears on the display when the batteries need to be changed.



INTRO PLAY

1. Press the MODE button three times; **INTRO** will display.
2. Press the PLAY/PAUSE button, starts **INTRO** play from track no.01.
3. Select **INTRO** mode during play; **INTRO** starts flashing.
 - Press the PLAY/PAUSE button. Flashing will stop and **INTRO** play will start from track no. 01.
 - Press **>>I** to play the current track. Flashing will stop, and **INTRO** play will start from next track.
 - Press **I<<**. Flashing will stop and **INTRO** play will start from current track.



PROGRAM PLAY

This allows selected tracks on the disc to be played in any desired order.

To set the program play

- Programming can be set in the STOP mode or normal play mode.
1. Press the PROG button; PROGRAM will start flashing.
 2. Press **I<<** or **>>I** to select the desired track.
 3. When the desired track is displayed, press the PROG button to register. The track No. display changes to 00 again.
 4. Repeat steps 2 and 3 to program the order of more tracks. Up to 20 tracks can be programmed into memory.



To complete programming and start playback

Press the PLAY/PAUSE button. PROGRAM will stop flashing and playback will begin.



To clear programming

- Register 00 on the first program track.
- Open the door.
- Power Off

RANDOM PLAY

Enables all the tracks on a disc to be played in a Random(Shuffle) sequence.

1. Press the MODE button four times; RANDOM will display.
2. Press the PLAY/PAUSE button. The Track No. is selected at random and will begin to play.
3. To select RANDOM mode during play, RANDOM starts flashing.
 - Press the PLAY/PAUSE button **I<<** or **>>I**. Flashing will stop and RANDOM play will begin.



SEARCH FUNCTION

Locating a Particular track

To go back to the beginning of the current or a previous track	Press I<< lightly and repeatedly.
To go to beginning of the following track	Press >>I lightly and repeatedly.

Locating a Particular Point in a track

To search backward at high speed	Keep I<< depressed.
To search forward at high speed	Keep >>I depressed.

Low level audio will be heard during the search process to assist in locating the correct point in the track.

USING ANTI-SHOCK (ESP) PROTECTION FEATURE

When activated the Anti-Shock (ESP) system immediately begins to store a buffer of sound data in the memory. The ESP indicator flashes until the memory is full.

When the laser loses tracking due to mechanical shock, the CD reading will be interrupted, but the audio playback will remain steady due to the memory buffer.

CAUTION

If the unit is subject to excessive and continuous repeated shocks, it will cause the sound to skip.

NOTES

- When the “ANTI-SHOCK (ESP)” mode is operating, the battery consumption is higher because the disc rotates faster than normal and the memory circuit is activated.
- When the digital anti-shock function is switched “ON” or “OFF”, the sound will be interrupted. This is normal.
- Remember that conditions such as dirty, scratched or warped discs may cause skipping or noise, thereby affecting performance of the “ANTI-SHOCK (ESP)” system.
- Skip protection greatly reduces or eliminates skipping during activity such as walking/running/driving. During such use, it's best to hold the compact disc player with the OPEN switch facing upward.

SPECIFICATIONS

PICK UP

Laser diode Material:	GaAlAs
Properties Wavelength:	$\lambda=780\text{nm}$
Emission duration:	continuous
Laser output:	$<44.6 \mu\text{W}$
Error correction:	Cross-interleave Reed-solomon code

AUDIO

D/A conversion:	DAC with four times oversampling
Frequency response:	20-20,000Hz (+1/-3 dB)
Wow and flutter:	Below measurable limits
No. of Channels:	2 Channels (Stereo)
Output level Phones:	15mW (32 Ω)
Bass boost effect:	(100Hz) + 6 dB

GENERAL

Power requirements:	2 "AA" alkaline batteries OR 6VDC 300 mA power adapter
Power adapter plug type:	EIAJ, center hole ϕ 1.7mm, outside ϕ 4.0mm
Power consumption:	0.8W (DC 3V) under normal conditions
Dimension Approx.:	144 x 140 x 27 mm
Weight Approx.:	200g not including battery

WARRANTY

Califone warrants this product to be free from defective material and workmanship for one year from the purchase date. Our "Project Intercept" Customer Satisfaction program will replace defective parts and repair malfunctioning equipment under this warranty when the defect occurs under normal use.

All Damage Claims Must Be Made With the Freight Carrier

Notify the freight carrier immediately if you observe any damage to the shipping carton or product. Repack the unit in the carton and await inspection by the carrier's claim agent. Notify your dealer of the pending freight claim.

Returning Your Unit for Service or Repairs

Should your unit require service, contact our Customer Service Department online at califone.com/techsupport or via email warranty@califone.com or by phone at 800-722-0500 / 818-407-2400 to first obtain an RA (Return Authorization) number before returning it to Califone. The unit must be returned to our factory via prepaid transportation only after the factory issues an RA number, which must be clearly written on the outside of the box.

Califone® International, Inc.
1145 Arroyo Avenue, #A
San Fernando, CA 91340 USA
Toll Free 800.722.0500 | Toll Free Fax 877.402.2248
International Customers call 818.407.2400 or Fax 818.407.2405
califone.com