



3-253-769-11(1)

Portable CD Player

Operating Instructions
Mode d'emploi



XP-ZV77/ZV77C/ZV77D

© 2003 Sony Corporation

English

WARNING

To prevent fire or shock hazard, do not expose the unit to rain or moisture.

Do not install the appliance in a confined space, such as a bookcase or built-in cabinet.

To prevent fire, do not cover the ventilation of the apparatus with newspapers, tablecloths, curtains, etc. And don't place lighted candles on the apparatus.

To prevent fire or shock hazard, do not place objects filled with liquids, such as vases, on the apparatus.

CAUTION

The use of optical instruments with this product will increase eye hazard.

Certain countries may regulate disposal of the battery used to power this product. Please consult with your local authority.

CAUTION

- INVISIBLE LASER RADIATION WHEN OPEN
- DO NOT STARE INTO BEAM OR VIEW DIRECTLY WITH OPTICAL INSTRUMENT

The validity of the CE marking is restricted to only those countries where it is legally enforced, mainly in the countries EEA (European Economic Area).

For the customer in Canada

To prevent electric shock, match wide blade of plug to wide slot, fully insert.

Table of Contents

Precautions	3
Using on the Rechargeable Batteries	4
Using on the dry batteries	6
Using on the AC power adaptor	7
Preparations	8
Loading a disc	9
Playing a disc	10
Playback options	13
Notes on MP3 discs	20
Maintenance	22
Troubleshooting guide	23
Specifications	23
Supplied accessories	24
Locating the controls	25

The instructions in this manual are for XP-ZV77, XP-ZV77C, and XP-ZV77D. Before you start reading, check your model number. XP-ZV77D is the model used for illustration purposes.

Precautions

On safety

- Should any solid objects or liquid fall into the CD player, unplug it and have it checked by qualified personnel before operating it any further.
- Do not put any foreign objects in the DC IN 4.5V (external power input) jack.

On the CD player

- Keep the lens on the CD player clean and do not touch it. If you do so, the lens may be damaged and the CD player will not operate properly.
- Do not put any heavy object on top of the CD player. The CD player and the CD may be damaged.
- Do not leave the CD player in a location near heat sources, or in a place subject to direct sunlight, excessive dust or sand, moisture, rain, mechanical shock, unlevelled surface, or in a car with its windows closed.
- If the CD player causes interference to the radio or television reception, turn off the CD player or move it away from the radio or television.
- Discs with non-standard shapes (e.g., heart, square, star) cannot be played on this CD player. Attempting to do so may damage the CD player. Do not use such discs.

On handling CDs

- To keep the CD clean, handle it by its edge. Do not touch the surface.
- Do not stick paper or tape onto the CD.



Not these ways

- Do not expose the CD to direct sunlight or heat sources such as hot air ducts. Do not leave the CD in a car parked under direct sunlight.

On headphones/earphones

Road safety

Do not use headphones/earphones while driving, cycling, or operating any motorized vehicle. It may create a traffic hazard and is illegal in some area. It can also be potentially dangerous to play your headsets at high volume while walking, especially at pedestrian crossings. You should exercise extreme caution or discontinue use in potentially hazardous situations.

Preventing hearing damage

Avoid using headphones/earphones at high volume. Hearing experts advise against continuous, loud and extended play. If you experience a ringing in your ears, reduce volume or discontinue use.

Consideration for others

Keep the volume at a moderate level. This will allow you to hear outside sounds and to be considerate to the people around you.

Usable discs

This CD player can play CD-Rs/RWs recorded in the CD-DA format* and MP3** files recorded in the CD-ROM format, but playback capability may vary depending on the quality of the disc and the condition of the recording device. Discs recorded in the formats other than those mentioned above, for example in VCD or CD-I format, cannot be played. In this manual, CD, CD-R and CD-RW are referred as "discs."

* CD-DA is the abbreviation for Compact Disc Digital Audio. It is a recording standard used for the Audio CDs.

**MP3 (MPEG 1 Audio Layer-3) is a standard technology and format for compressing a sound sequence.

Using on the Rechargeable Batteries

When using on the rechargeable batteries for the first time, charge them until “CHARGE ON” goes out. You can use only the following rechargeable batteries for your CD player: Commercially-available size AA Ni-MH rechargeable batteries of 1.2 V DC, 700 mAh

- 1 Open the battery compartment lid inside your CD player.

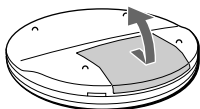

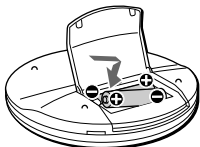

- 2 Insert two rechargeable batteries by matching the ⊕ to the diagram in the battery compartment and close the lid until it clicks into place.

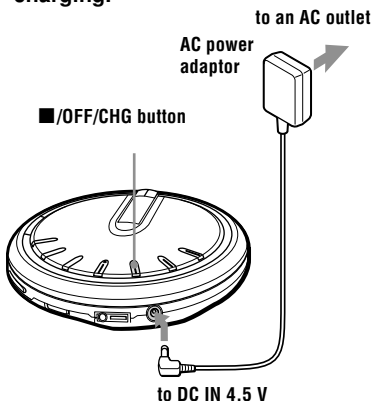

Insert the ⊖ end first (for both batteries).

- 3 Connect the AC power adaptor to the DC IN 4.5 V jack of your CD player and an AC outlet, and then press and hold ■/OFF/CHG for about 1 second while the CD player is turned off to start charging.



“CHARGE ON” appears in the display, and the indicator sections of  light up in succession. When the batteries are completely charged, all indications in the display disappear.

Notes

- During charging, the CD player and the rechargeable batteries become hot. This poses no danger.
- If you press ► ||/ENTER during charging, charging stops and playback of the CD starts.
- Use only the supplied AC power adaptor.

When to charge the rechargeable batteries

You can check the remaining power of the batteries in the display.



Battery power is full.



Battery power is getting low.



Battery power is low.



Low-BATT Batteries are depleted.

To keep the original battery capacity for a long time, charge the batteries only when they are completely depleted.

When to replace the rechargeable batteries

If the battery life becomes shorter by about half, replace the batteries with new rechargeable batteries.



Note on the rechargeable batteries

If the battery is new or has not been used for a long time, it may not be charged completely until you charge and discharge it several times.

Note on carrying the rechargeable batteries

If the rechargeable batteries and the metallic objects are contacted, heat or fire may occur due to a short circuit.

Notes

- The indicator sections of  roughly show the remaining battery power. One section does not always indicate one-fourth of the battery power.
- Depending on operating conditions, the indicator sections of  may increase or decrease.

Using on the dry batteries

Use only the following dry battery type for your CD player:
LR6 (size AA) alkaline batteries

- 1 **Open the battery compartment lid inside your CD player.**

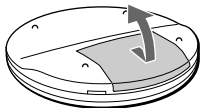

- 2 **Insert two dry batteries by matching the ⊕ to the diagram in the battery compartment and close the lid until it clicks into place.**

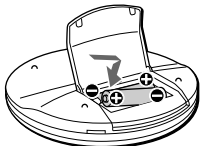

Insert the ⊖ end first (for both batteries).

When to replace the batteries

You can check the remaining power of the batteries in the display.



Battery power is full.



Battery power is getting low.



Battery power is low.



Low-BATT Batteries are depleted.

When the batteries are depleted, replace both batteries with new ones.

Note

Be sure to remove the AC power adaptor when using the dry batteries.

Using on the AC power adaptor

Connect the supplied AC power adaptor to the DC IN 4.5 V jack and an AC outlet.

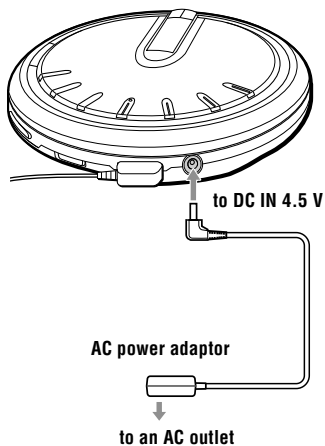

Notes

- Be sure to remove the rechargeable batteries when the CD player is used with the AC power adaptor for a long time to prevent the functional deterioration to the rechargeable batteries.
- Disconnect the AC power adaptor from the AC outlet after use.
- Turn off the power of the CD player before you connect and disconnect the AC power adaptor.

Notes on the power source

Disconnect all power sources when the CD player is not used for a long time.

On AC power adaptor

- Use only the supplied AC power adaptor. Do not use any other AC power adaptor. It may cause a malfunction.



Polarity of the plug

- Do not touch the AC power adaptor with the wet hands.
- Connect the AC power adaptor to an easily accessible AC outlet. Should you notice an abnormality in the AC power adaptor, disconnect it from the AC outlet immediately.
- Do not install the AC power adaptor in a confined space, such as a bookcase or built-in cabinet.
- To prevent fire or shock hazard, do not place objects filled with liquids, such as vases, on the AC power adaptor.

On rechargeable batteries and dry batteries

- Do not charge the dry batteries.
- Do not throw the batteries into fire.
- Do not carry the batteries with coins or other metallic objects. It can generate heat if the positive and negative terminals of the battery are accidentally contacted by a metallic object.
- Do not mix rechargeable batteries with dry batteries.
- Do not mix new batteries with old ones.
- Do not use different types of batteries together.
- When the batteries are not to be used for a long time, remove them.
- If battery leakage occurs, wipe off any deposit in the battery compartment, and install new batteries. In case the deposit adheres to you, wash it off thoroughly.

Preparations

HOLD switch

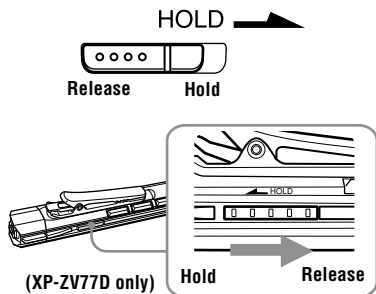

Release the HOLD switch before playback.
When not using the unit, set the HOLD switch to the HOLD position. Accidentally pressed button will not function.
If buttons on the CD player are pressed when the HOLD switch is set to the HOLD position, "HOLD" flashes in the display.

Turning on and off

Turning on the CD player

Press ►||/ENTER.
Power is turned on.

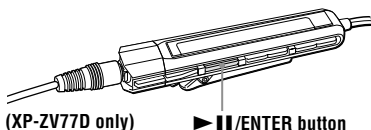
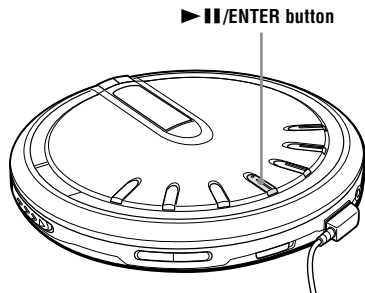

Turning off the CD player

During playback, press ■ to stop playback, and press it again. "POWER OFF" appears in the display on the remote control, and the power is turned off.
If no operation is done within 15 seconds after you stop playback, the power is automatically turned off.

Loading a disc

For XP-ZV77D, connect the supplied earphones with the remote control to the Ω jack of the CD player.

- 1 Slide OPEN to open the CD player lid.

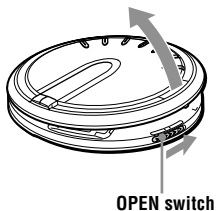

- 2 Place the disc on the tray.

Fit the disc to the pivot securely until it clicks, with the label side up.

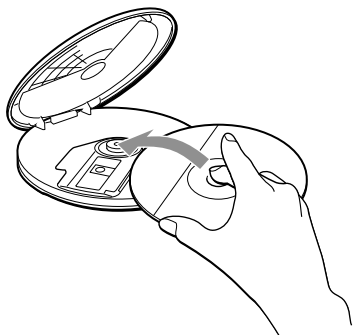

- 3 Close the CD player lid securely until it clicks.

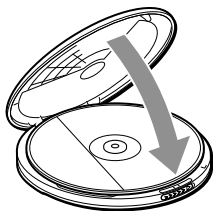

When the CD player lid is closed

The following display is shown on the display of the remote control.

Audio disc

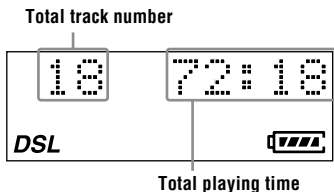

MP3 disc

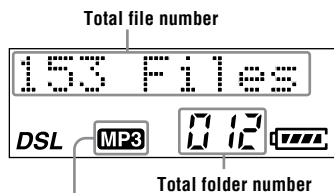

Appears when the MP3 disc is loaded

Removing the disc

Remove the disc while pressing the pivot in the center of the tray.

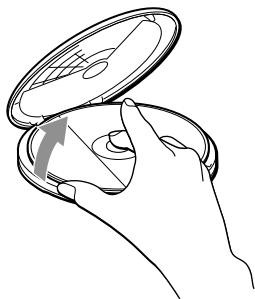

Playing a disc

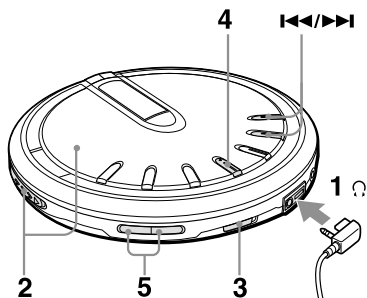

1 Connect the headphones/earphones firmly.

Connect the plug of the headphones/earphones firmly to the CD player. A loose connection may cause noise during playback.

2 Load a disc.

3 Release HOLD.

4 Press ►||/ENTER.

The power is turned on and “READING” flashes. Playback starts.

Audio disc

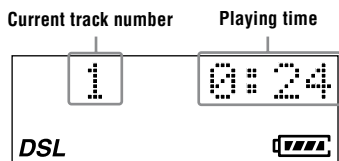

MP3 disc

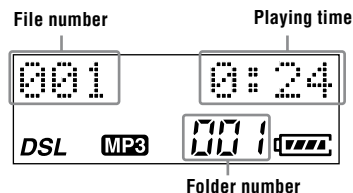

5 Adjust the volume.

Press VOL -/+ . To operate with the remote control supplied with XP-ZV77D, turn VOL +/-.

Basic operations

To	Do this
Pause/Resume play after pause	Press ► /ENTER.
Stop	Press ■/OFF/CHG. With the remote control of XP-ZV77D, press ■.
Find the beginning of the current track (file)	Press ◀◀ once. *
Find the beginning of the previous tracks (files)	Press ◀◀ repeatedly. *
Find the beginning of the next track (file)	Press ▶▶ once. *
Find the beginning of the succeeding tracks (files)	Press ▶▶ repeatedly. *
Go backwards quickly	Press and hold ◀◀. *
Go forward quickly	Press and hold ▶▶. *
Select a folder (on MP3 disc playback)	Press FOLDER SKIP -/+ . With the remote control of XP-ZV77D, press ◻ -/+ .

*These operations can be done during both play and pause.

Resume playback after you stopped playback

Press ►||/ENTER. Playback starts from the point you stopped.

To start playback from the beginning of the disc, press and hold ►||/ENTER until playback starts.

If “ERROR” is displayed

“ERROR” is displayed when the disc is loaded with the label side down, or the disc loaded is defective. Check the disc.

If “NO DISC” is displayed

“NO DISC” is displayed when no disc is loaded. Load a disc, and press ►||/ENTER again.

Music discs encoded with copyright protection technologies

This product is designed to play back discs that conform to the Compact Disc (CD) standard. Recently, various music discs encoded with copyright protection technologies are marketed by some record companies. Please be aware that among those discs, there are some that do not conform to the CD standard and may not be playable by this product.

Note on moisture condensation

If the CD player is suddenly moved from a cold place to a warm place, it may result in moisture condensation on the pickup lens and malfunction or playback difficulties. Should this occur, leave the CD player for a few hours, then try playback again.

About the display

Press DISPLAY during playback to display various information on the display.

Each time you press DISPLAY, the display changes as follows.

Remaining time of the current track
(during playback of discs without CD
TEXT information)

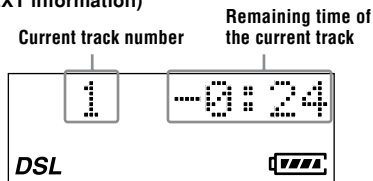

Remaining time of the disc*

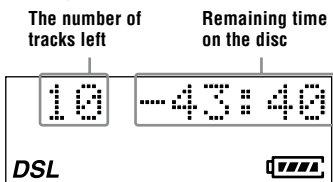

*Not displayed during Shuffle play.

Returns to the normal display

Audio disc

Normal display

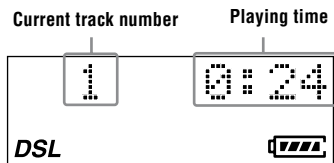

CD TEXT information (during playback of
discs with CD TEXT information)

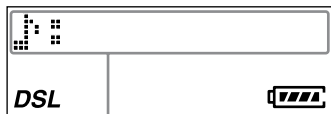

CD TEXT information

- ⋮ : Title
- ⋮ : Artist name
- ⋮ : Disc name

Playing a disc

About the CD TEXT information

- This CD player can display the CD TEXT information written in English only. Discs can contain information written in other languages than English, but they are shown as “NO TITLE” or not shown on the display.
- The following characters may not be displayed correctly:
[¥] { | } ~

MP3 disc

Normal display

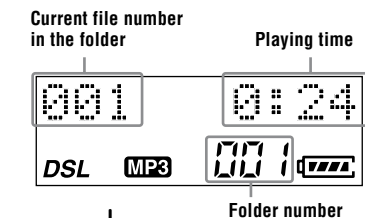

Folder name/file name

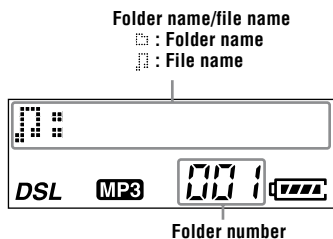

ID3 tag information*

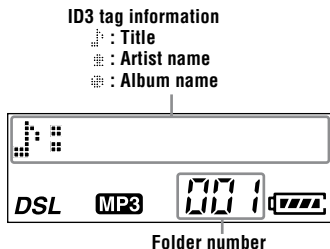

* When the file does not have ID3 tag information, “NO TITLE” appears in the display.

Total file number (except during Play list play)

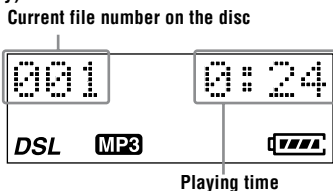

Play list name (during Play list play)



Returns to the normal display

Playback options

You can enjoy various playback options using the P-MODE/☞, FOLDER SKIP-/+ (☐-/+), ◀◀/▶▶, and ▶||/ENTER buttons.

Selecting the function you want to set

- 1 Press P-MODE/☞ during play or stop.
- 2 Press FOLDER SKIP-/+ (☐-/+) repeatedly until the desired function name appears in the display.
- 3 Press ◀◀/▶▶ to make the setting of the function.
- 4 Press ▶||/ENTER to decide the selected setting.
- 5 Wait for about 10 seconds or press P-MODE/☞ or ▶||/ENTER. Normal display comes back.

To set the other function

Repeat step 2 and 3 before step 5.

Each time you press FOLDER SKIP-/+ (☐-/+) in step 2, display changes as follows.

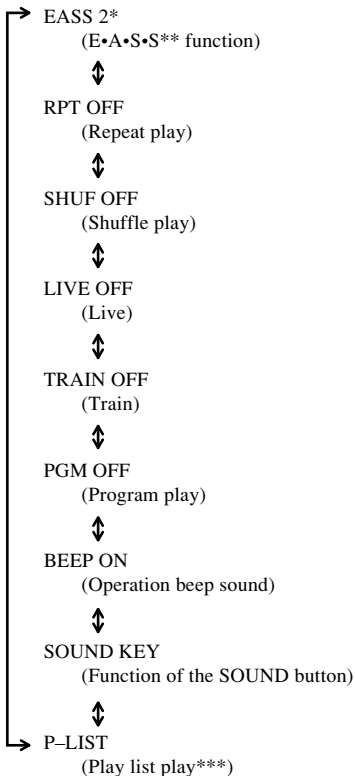

* Appears only when the audio disc is loaded. Set the function when the play is stopped or in pause.

**E•A•S•S = Electronic Anti-Shock System

***Appears only when the loaded MP3 disc has at least one play list file. Set the function when the play is stopped.

Playback options

E•A•S•S function

The E•A•S•S function reduces skipping or muting of the sound when the unit is subjected to shocks.

- 1 Press **P-MODE/↶** during play or stop.
- 2 Press **FOLDER SKIP -/+ (⏮-/+)** repeatedly until “EASS 2” appears in the display.
- 3 Press **◀/▶/▶▶** to select “EASS 1” or “EASS 2.”

When you select “EASS 2”, the E•A•S•S function will be enhanced compared to “EASS 1”. To walk with the CD player and enjoy high quality CD sound using the E•A•S•S function, select “EASS 1.” While taking harder exercise, it is recommended that you select “EASS 2.”

- 4 Press **▶||/ENTER**.

Notes

- Sound may skip:
 - if the CD player receives stronger continuous shock than expected.
 - if a dirty or scratched disc is played or
 - when using poor-quality CD-Rs/CD-RWs or if there is a problem with the original recording device or application software.
- Playback pauses for about 2 seconds when the E•A•S•S setting is changed during playback.
- The E•A•S•S setting does not appear when the MP3 disc is loaded.

Repeat play

You can play one track (file) or all tracks (files) repeatedly in normal, Shuffle, and Program modes.

- 1 Press **P-MODE/↶** during play or stop.
- 2 Press **FOLDER SKIP -/+ (⏮-/+)** repeatedly until “RPT OFF” appears in the display.

- 3 Press **◀/▶/▶▶** to select the way you repeat the tracks (files).

Audio disc

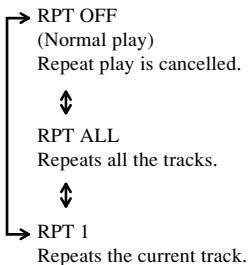

MP3 disc

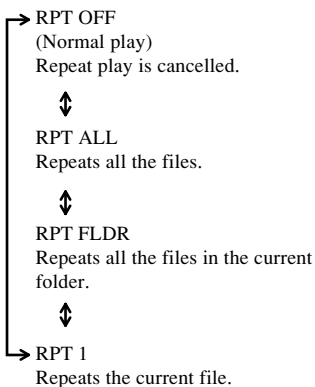

- 4 Press **▶||/ENTER**.



Repeat play indication

To start All Repeat play

Press and hold **P-MODE/↶** for about 2 seconds during normal play. All Repeat play starts.

To cancel Repeat play

Select "RPT OFF" in step 3. During Repeat play, you can cancel Repeat play by pressing and holding P-MODE/↵ for about 2 seconds during play or in pause.

Shuffle play

You can play tracks (files) in a random order.

- 1 Press P-MODE/↵ during play or stop.
- 2 Press FOLDER SKIP -/+ (□-/+) repeatedly until "SHUF OFF" appears in the display.
- 3 Press ◀▶/▶▶ to select "SHUF ON."
- 4 Press ▶||/ENTER.



Shuffle play indication

To cancel Shuffle play

Select "SHUF OFF" in step 3, and press ▶||/ENTER.

To repeat all the tracks (files) on the disc in Shuffle play

Press and hold P-MODE/↵ during Shuffle play.

Notes

- You cannot go back to the previous track (file) by pressing ◀◀ during Shuffle play.
- You cannot select "RPT 1" or "RPT FLDR" during Shuffle play.

Making the sound wider and deeper (LIVE)

You can listen to the track (file) in a wider and deeper sound as if you were in a concert hall.

- 1 Press P-MODE/↵ during play or stop.
- 2 Press FOLDER SKIP -/+ (□-/+) repeatedly until "LIVE OFF" appears in the display.
- 3 Press ◀◀/▶▶ to select "LIVE ON."
- 4 Press ▶||/ENTER.

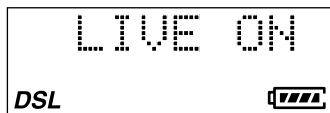

To listen to the normal sound

Select "LIVE OFF" in step 3, and press ▶||/ENTER.

Playback options

Making the sound soft to ears (TRAIN)

You can listen to the track (file) in a gentle sound so that you will not feel tired in listening. This also reduces sound leakage from the headphones to the people around you in a crowded place such as in a train.

- 1 Press **P-MODE/** during play or stop.
- 2 Press **FOLDER SKIP -/+ (-/+)** repeatedly until "TRAIN OFF" appears in the display.
- 3 Press **I◀/▶I** to select "TRAIN ON."
- 4 Press **▶II/ENTER**.



To listen to the normal sound

Select "TRAIN OFF" in step 3, and press **▶II/ENTER**.

Program play

You can program the CD player to play up to 24 tracks (files) in your favourite order.

- 1 Press **P-MODE/** during play or stop.
- 2 Press **FOLDER SKIP -/+ (-/+)** repeatedly until "PGM OFF" appears in the display.
- 3 Press **I◀/▶I** to select "PGM ON."
- 4 Press **▶II/ENTER**.

Audio disc

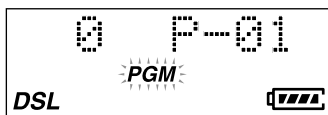

MP3 disc



- 5 Press **-/+** to select folder when playing an MP3 disc.

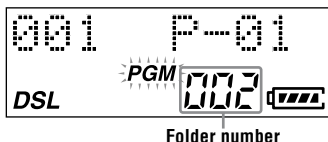

- 6 Press **I◀/▶I** to select the track (file).

Audio disc

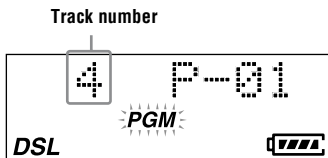

MP3 disc

File number

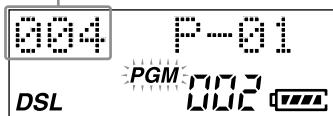

- 7 Press **▶||/ENTER** to enter the selected track (file).

The selected track (file) is stored in the program.

Repeat step 4 to 6 to select the tracks (files) in your favourite order.

- 8 Press and hold **▶||/ENTER** until Program play starts.

To check the program during Program play

Press **■/OFF/CHG (■)** to stop Program play, and press **◀◀/▶▶** repeatedly. Each time you press **◀◀/▶▶**, the track number appears.

When you press **▶||/ENTER** shortly, Program play resume from the beginning of the track (file) you select by **◀◀/▶▶**.

When you finish entering the 24th track (file)

“PGM-FULL” appears in the display to show that you cannot add any more track (file) to the program.

To cancel Program play

Select “PGM OFF” in step 2, and press **▶||/ENTER**.

Note

During Program play, you cannot add tracks (files) to the program.

Turning off the operation beep sound

You can turn off the beep sound that is heard from your headphones/earphones when you operate your CD player.

- 1 Press **P-MODE/↵** during play or stop.
- 2 Press **FOLDER SKIP -/+ (⏪-/+)** repeatedly until “BEEP ON” appears in the display.
- 3 Press **◀◀/▶▶** to select “BEEP OFF.”
- 4 Press **▶||/ENTER**.



To turn on the beep sound

Select “BEEP ON” in step 2, and press **▶||/ENTER**.

Playback options

Setting the function of the SOUND button

Select the function assigned to the SOUND button. The SOUND button can work as the DSL* button, the sentence repeat button, or the phrase repeat button.

*DSL = Dynamic Super Linear Bass

DSL function

You can emphasize the bass-boosted sound. Each time you press SOUND, the display changes as follows:

DSL OFF (cancel)
↓
DSL 1
↓
DSL 2
↓
DSL OFF

“DSL 2” enhances the bass sound more than “DSL 1.”
SOUND works as the DSL button as a default.

Sentence repeat function

The CD player returns to the latest no-sound portion, and starts playback from there.

Notes

- During playback of an MP3 disc, Sentence repeat function may not work properly.
- Sentence repeat function becomes effective when the no-sound portion is played at least once after you assign Sentence repeat function to the SOUND button.

Phrase repeat function

The CD player goes back by 5 seconds, and starts playback from there.

- 1 Press P-MODE/⏏ during play or stop.
- 2 Press FOLDER SKIP -/+ (⏏-/+)
repeatedly until “SOUND KEY”
appears in the display.
- 3 Press ◀▶ to select the
function you want to assign to the
SOUND button.

Each time you press ◀▶, the display
changes as follows:

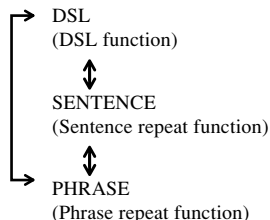

- 4 Press ▶||/ENTER.



Starting a Play list play (only for MP3 discs)

When you record MP3 files on the disc, you can record the play list files. The play list contains the order of the files on the disc, and you can play the disc according to the order specified in the play list file. Recording some play list files allows you to play the same disc in a different combination of the files in a different order.

The play list play cannot be done if an MP3 disc has no play list file in it, if the recorded play list file is named inappropriately, or if the information in the play list file is written inappropriately.

- 1 Press **P-MODE**/ \leftarrow in stop.
- 2 Press **FOLDER SKIP** $-/+$ (\square $-/+$) repeatedly until “**P-LIST --**” appears in the display.



- 3 Press \leftarrow/\rightarrow to select the play list file you want to use.
Play list file name



- 4 Press and hold \blacktriangleright \parallel / **ENTER** for about 2 seconds.

Play list play starts following the information in the selected play list file.



Number of the selected play list file

To cancel the Play list play and start normal play

Select “OFF” in step 3, and press and hold \blacktriangleright \parallel / **ENTER** for about 2 seconds. Normal playback starts.

To repeat the Play list play

During Play list play, select “RPT ALL”, or press and hold **P-MODE**/ \leftarrow for about 2 seconds. All the files in the play list file will be played repeatedly.

To play the files in the play list in a random order

During Play list play, select “SHUF ON.”

Notes

- The CD player recognizes the files with an extension “.m3u” as the play list files.
- The CD player recognizes up to 20 play list files.
- The MP3 files specified in the play list files are up to 500 files as a total of all the play list files recorded in an MP3 disc.
- During Play list play, you cannot select Program play. You cannot select a folder nor repeat all the files in a folder.

Note on the file name of the play list file

The name of the play list file should have 30 bytes or less including its extension “.m3u” (11 characters before the extension on the Joliet format disc, and 26 characters before the extension on other format disc).

The files with longer name cannot be used as the play list file on this CD player.

For XP-ZV77D only

“ \square ” appears in the display of the supplied remote control when you load an MP3 disc with the valid play list files recorded correctly.

Notes on MP3 discs

This CD player can play the discs with MP3 files recorded in CD-ROM format or on the CD-Rs/RWs as well.

Playable files

To enjoy the MP3 files on this CD player, the files must be recorded in the format compliant with the ISO9660 standard.

About MP3

- MP3 (MPEG 1 Audio Layer-3) is a standard technology and format for compressing a sound sequence.
- The files with “.mp3” as the extension can be regarded as MP3 files. The files with “.m3u” as the extension can be regarded as play list files.
- This CD player cannot recognize the files with the extension other than “.mp3” or “.m3u.”
- The files with the extension “.mp3” that are not recorded in the MP3 format cannot be played properly on this CD player.

Playable MP3 files on this player

You can only play MP3 files recorded by following requirements.

USABLE MEDIA

CD-Rs and CD-RWs

USABLE DISC FORMAT

You can use ISO 9660 Level 1/2 format, Joliet extension format, and Romeo format discs. This unit can display only 1-byte characters. (2-byte characters like those of Japanese are displayed as “*.”)

The major specification of the usable disc format is:

- Maximum directory steps: 8 (9 on the Joliet format discs)
- Maximum number of characters for a file name and a folder name:
 - 15 and a 3-character extension code on the Joliet format discs
 - 30 and a 3-character extension code on other than Joliet format discs

THE USABLE NUMBER OF FOLDERS/FILES

- Maximum number of folders: 255 (depending on the number of files)
- Maximum number of files: 999

This CD player can play back MP3 files of the following sampling frequencies:

MPEG 1: 32 kHz, 44.1 kHz, 48 kHz

MPEG 2: 16 kHz, 22.05 kHz, 24 kHz

MPEG 2.5: 8 kHz, 11.025 kHz, 12 kHz

Notes on playing MP3 files

- If a disc contains audio (CD-DA) tracks and MP3 files, this CD player plays only the audio tracks.
- This CD player may not play files in their order they were recorded.
- E•A•S•S memory duration is approximately 100 seconds at the longest with files of 128 kbps bit rate.
- This CD player can play back MP3 files of the following bit rates:
 - MPEG 1/Audio Layer 3: 32 kbps – 320 kbps
 - MPEG 2/Audio Layer 3: 8 kbps – 160 kbps
 - MPEG 2.5/Audio Layer 3: 8 kbps – 160 kbps

This CD player is best suited for playback of tracks with a bit rate of 128 kbps. The sound may be intermittent or distorted during playback of tracks encoded with a certain encoder or encoded with bit rate over 128 kbps.

- The playing time may not be displayed correctly when variable-bit-rate (VBR) files are played.
- Depending on the encoder to create MP3 files, noise may be heard or sound may be intermittent when MP3 files are played on this CD player.
- Sound is muted for a moment with the disc that contains no silent portion between songs (files) such as a disc with a recording of a live performance, etc.
- When files encoded in the MP3 Pro format are played back on this CD player, their sound quality may not be as high as they should be.

- When there are many folders or non-MP3 files on the disc, it may take a long time for play to begin or for the next MP3 file to start play. Do not save unnecessary folders or files other than MP3 ones in the disc to be used for MP3 listening.

On the method of storing files on discs

There are 3 utilities used to record data on a disc.

1 DAO (Disc At Once) utility

All data to be written must be prepared in advance and written onto a disc from the beginning to the end in one operation. No data can be added to a disc on which data were already written with DAO utility.

2 TAO (Track At Once) utility

Data are written onto a disc track by track. Data can be added to a disc on which data were written with TAO utility.

3 Packet writing utility

Tracks are divided into smaller pieces while being recorded, depending on the size of available spaces on the disc. Data can be added to a disc on which data were written with packet writing utility.

This CD player can play MP3 files recorded using DAO and TAO utilities. Files recorded by packet writing utility cannot be played.

Notes on display indications during play

- Up to 30 bytes (not including its file extension) are displayed for the file name and the folder name.
- The following characters may not be able to be displayed:
[¥] { | } ~
- Characters that cannot be displayed correctly will be shown as *.

To play tracks in the order they were recorded

- 1 Use a writing software capable of recording MP3 files in numerical and alphabetical order.
For details on using the software, refer to the operating instructions supplied with the software.
- 2 Use only one folder. Do not create a sub folder within a folder.
- 3 Include a two-digit or three-digit number at the beginning of each folder or file name so that the folders and files are played in order.

<example of recommended names>

```
01xxxxxx.mp3
02xxxxxx.mp3
03xxxxxx.mp3
04xxxxxx.mp3
05xxxxxx.mp3
```

<example of names not recommended>

```
1xxxxxxx.mp3
5xxxxxxx.mp3
10xxxxxx.mp3
15xxxxxx.mp3
20xxxxxx.mp3
```

In this case, the files are played in the order of “1”, “10”, “15”, “20”, and “5.”

Notes on MP3 discs

Example of folder structure and playing order

The playing order of folders and files is as follows:

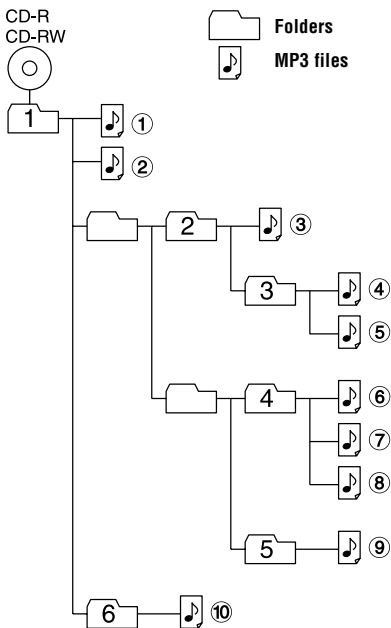

Maintenance

To clean the lens

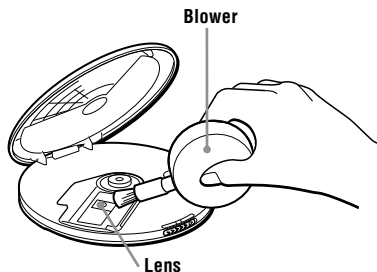

If the lens becomes dirty, the player will skip or not play. If this occurs, clean the lens in the following manner

To remove dust or dry particles, first use a camera lens blower/brush to blow a few times to loosen particles, then gently brush the lens clean. Finish by blowing the lens again

To remove fingerprints, use a cotton swab dipped in lens cleaning solution. Wipe gently from the center to the edge. Lens cleaning solution is commercially available.

Note

Take care not to get too much solution on the swab that could flow into the unit and cause damage.

Pressing too strongly with the swab could scratch or break the lens.

To clean the discs

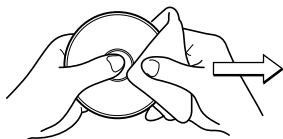

Before playing, wipe the disc from the center outward with a cleaning cloth. After playing, store the disc in its case.

Troubleshooting guide

Should any problem persist after you have checked these symptoms, consult your nearest dealer.

Playback does not start.

- Connect the AC power adaptor firmly.
- Insert the batteries with the correct polarity.
- Charge the rechargeable batteries.
- Check that the disc is inserted with the label side up.
- Clean the disc or the lens.
- Close the disc compartment lid.
- Release the HOLD switch.
- Press ► **II**/ENTER to cancel pause.
- There is a moisture condensation. Leave the unit for a few hours and then try to play again.
- While “POWER OFF” is shown in the display, playback does not start even if you press ► **II**/ENTER. Wait until “POWER OFF” goes off, and press ► **II**/ENTER to start playback.

No sound

- Connect the headphones/earphones firmly to the Ω jack on the CD player. For XP-ZV77D, also connect the earphones to the remote control firmly.
- Turn up the volume gradually.

Sound skips. Sound is intermittent.

- Clean the disc or lens.
- Check whether the CD player is subjected to strong vibrations.
- Use the new batteries, or charge the rechargeable batteries.

Charging cannot be done.

- Connect the AC power adaptor firmly.
- Check that the rechargeable batteries are installed with the correct polarity.
- Connect the AC power adaptor to the DC IN 4.5V jack, and press **■**/OFF/CHG to start charging.

Specifications

System

Compact disc digital audio system

Laser diode properties

Material: GaAlAs

Wavelength: $\lambda = 780 \text{ nm}$

Emission duration: Continuous

Laser output: Less than $44.6 \mu\text{W}$

(This output is the value measured at a distance of 200 mm from the objective lens surface on the optical pick-up block with 7 mm aperture.)

D-A conversion

1 bit DAC

Frequency response

20 – 20 000 Hz +1 –2 dB (measured by JEITA CP-307)

Output (at 4.5 V input level)

For the area code of the model you purchased, check the upper left side of the bar code on the package.

Headphones (stereo minijack)

EU8 and CEK models: Approx. 4.5 mW + 4.5 mW at 16 Ω

MX2, E33, CA2 and AU2 models: Approx. 5 mW + 5 mW at 16 Ω

Power requirements

For the area code of the model you purchased, check the upper left side of the bar code on the package.

- Two Ni-MH rechargeable batteries (size AA): 2.4 V DC
- Two LR6 (size AA) batteries: 3 V DC
- AC power adaptor (DC IN 4.5 V jack):
EU8 and E33 models: 100 – 240 V, 50/60 Hz
CEK model: 230 V, 50 Hz
CA2 and MX2 models: 120 V, 60 Hz
AU2 model: 240 V, 50 Hz

Specifications

Battery life* (approx. hours)

(When you use the CD player on a flat and stable surface.)

Playing time varies depending on how the CD player is used.

Using two Sony alkaline batteries LR6 (SG) (produced in Japan)

	EASS 1	EASS 2
Audio disc	30	26
MP3 disc	—	32

* Measured value by the standard of JEITA (Japan Electronics and Information Technology Industries Association).

Operating temperature

5°C – 35°C (41°F – 95°F)

Dimensions (w/h/d) (excluding projecting parts and controls)

Approx. 136 × 22.7 × 139 mm (5 ³/₈ × 29/₃₂ × 5 ¹/₂ in.)

Mass (excluding accessories)

Approx. 222 g (7.8 oz)

Design and specifications are subject to change without notice.

Supplied accessories

XP-ZV77

AC power adaptor (1)
Headphones/Earphones (1)

XP-ZV77C

AC power adaptor (1)
Headphones/Earphones (1)
Car connecting pack (1)
Car batter cord (1)
Velcro tape (2)

XP-ZV77D

AC power adaptor (1)
Earphones with remote control (1)

Locating the controls

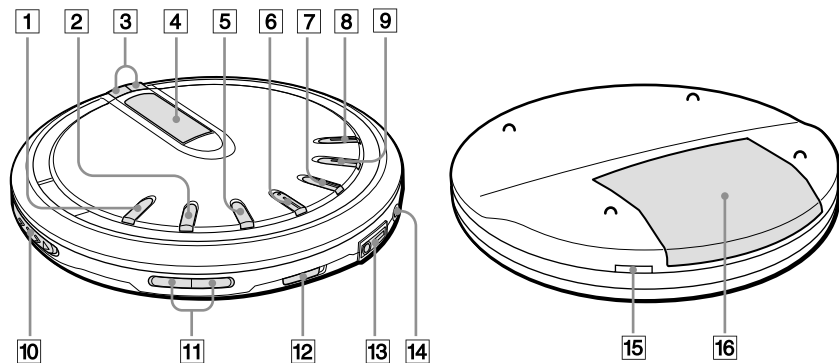

- 1 P-MODE/↵ button
- 2 SOUND button
- 3 FOLDER SKIP -/+ buttons
- 4 Display
- 5 DISPLAY button
- 6 ►||/ENTER button*
- 7 ■/OFF/CHG button
- 8 ◀◀ button
- 9 ▶▶ button
- 10 OPEN switch
- 11 VOL +*/- buttons
- 12 HOLD switch
- 13 Ω (headphones) jack
- 14 DC IN 4.5V jack

- 15 Hand strap hole
- 16 Battery compartment

* The button has a tactile dot.

Locating the controls

Remote control supplied with XP-ZV77D

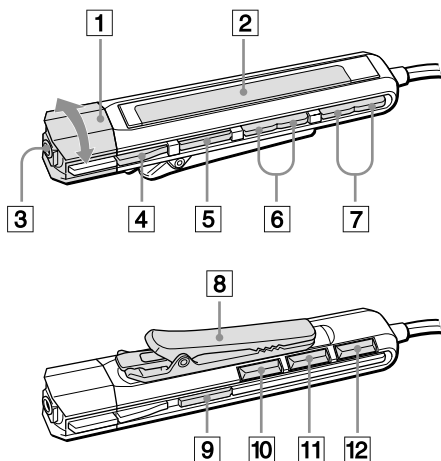

- 1 VOL +/- knob
- 2 Display
- 3 Headphone jack
- 4 ■ button
- 5 ▶||/ENTER button*
- 6 □-/+ buttons
- 7 ◀◀/▶▶ buttons
- 8 Clip
- 9 HOLD switch
- 10 SOUND button
- 11 DISPLAY button
- 12 P MODE/↵ button

*The button has a tactile dot.

To use the clip on the remote control

You can remove the clip from the remote control and change the direction of the clip.

To remove

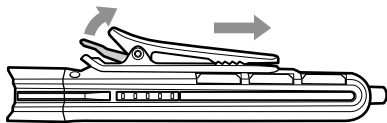

To attach in the reverse direction

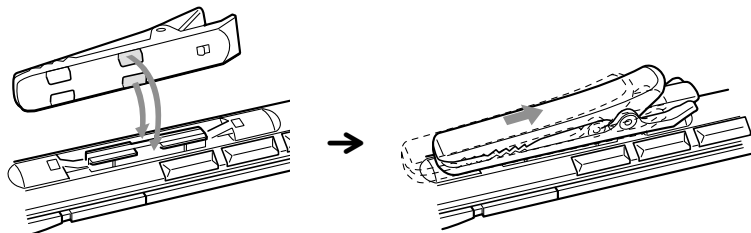

Example of the display on the remote control (XP-ZV77D only)

Audio disc

When the CD is loaded (page 9)

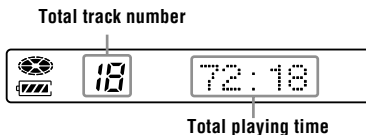

During normal play (page 10)

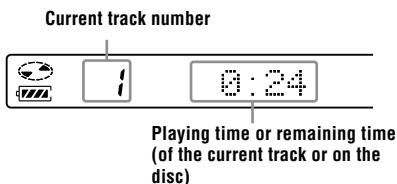

CD TEXT information (page 11)

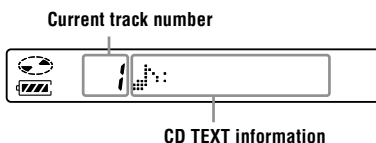

During programming (page 16, 17)

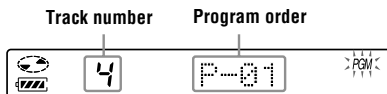

MP3 disc

When the CD is loaded (page 9)

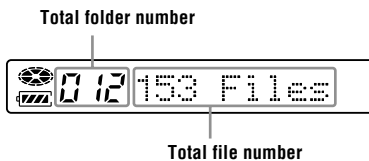

During normal play (page 10)

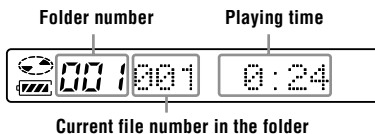

ID3 tag information (page 12)

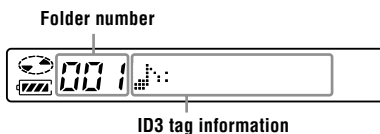

Play list name (page 12, 19)

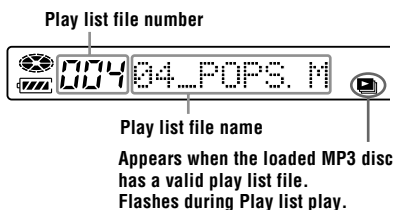

During programming (page 16, 17)

