

# FM/AM Portable CD Player

---

## Operating Instructions

### Owner's Record

The model number and the serial number are located at the rear of the CD player. Record the serial number in the space provided below. Refer to these numbers whenever you call upon your Sony dealer regarding this product.

Model No. \_\_\_\_\_

Serial No. \_\_\_\_\_



**Atrac3plus**

“WALKMAN” is a registered trademark of Sony Corporation to represent Headphone Stereo products.  is a trademark of Sony Corporation.

## D-NF400/NF401

## WARNING

To prevent fire or shock hazard, do not expose the unit to rain or moisture.

Do not install the appliance in a confined space, such as a bookcase or built-in cabinet.

To prevent fire, do not cover the ventilation of the apparatus with newspapers, tablecloths, curtains, etc. And don't place lighted candles on the apparatus.

To prevent fire or shock hazard, do not place objects filled with liquids, such as vases, on the apparatus.

### CAUTION

The use of optical instruments with this product will increase eye hazard.

Certain countries may regulate disposal of the battery used to power this product. Please consult with your local authority.

### CAUTION

- INVISIBLE LASER RADIATION WHEN OPEN
- DO NOT STARE INTO BEAM OR VIEW DIRECTLY WITH OPTICAL INSTRUMENTS
- CLASS 1M INVISIBLE LASER RADIATION WHEN OPEN
- DO NOT VIEW DIRECTLY WITH OPTICAL INSTRUMENTS

The validity of the CE marking is restricted to only those countries where it is legally enforced, mainly in the countries EEA (European Economic Area).

ATRAC3plus and ATRAC3 are trademarks of Sony Corporation.

## For customers who purchased this product in the USA

### Product registration

Please register this product on line at [www.sony.com/walkmanreg](http://www.sony.com/walkmanreg)  
<<http://www.sony.com/walkmanreg>>

Proper registration will enable us to send you periodic mailings about software upgrades, new products, services and other important announcements. Thank you.

**If you have any questions about this product, you may call; Sony Customer Information Services Center 1-866-456-7669 or <http://www.sony.com/>**

### Declaration of Conformity

Trade Name: SONY  
Model: D-NF400  
Responsible Party: Sony Electronics Inc.  
Address: 16450 W. Bernardo Dr,  
San Diego, CA 92127 U.S.A.

Telephone Number: 858-942-2230  
This device complies with Part 15 of the FCC Rules. Operation is subject to the following two conditions: (1) This device may not cause harmful interference, and (2) this device must accept any interference received, including interference that may cause undesired operation.

This equipment has been tested and found to comply with the limits for a Class B digital device, pursuant to Part 15 of the FCC Rules. These limits are designed to provide reasonable protection against harmful interference in a residential installation. This equipment generates, uses, and can radiate radio frequency energy and, if not installed and used in accordance with the instructions, may cause harmful interference to radio communications. However, there is no guarantee that interference will not occur in a particular installation. If this equipment does cause harmful interference to radio or television reception, which can be determined by turning the equipment off and on, the user is encouraged to try to correct the interference by one or more of the following measures:

- Reorient or relocate the receiving antenna.
- Increase the separation between the equipment and receiver.
- Connect the equipment into an outlet on a circuit different from that to which the receiver is connected.
- Consult the dealer or an experienced radio/TV technician for help.

You are cautioned that any changes or modifications not expressly approved in this manual could void your authority to operate this equipment.

# Table of Contents

## **Enjoy your ATRAC CD Walkman!**

Music sources playable on this CD player ..	6
ATRAC3plus and ATRAC3 .....	7
MP3 .....	7
The structure of ATRAC3plus/ATRAC3 and MP3 files .....	8

## **Getting started**

Checking the supplied accessories .....	10
Locating the controls .....	11

## **Playing a CD**

1. Insert a CD. ....	13
2. Connect your CD player. ....	13
3. Play a CD. ....	13

## **Playback options**

Playing tracks repeatedly (Repeat play) ....	16
Playing all files in a selected group (Group play) (ATRAC CD/MP3 CD only) .....	16
Playing a single track (Single play) .....	17
Playing tracks in random order (Shuffle play) .....	17
Playing all files in a selected group in random order (Group shuffle play) (ATRAC CD/MP3 CD only) .....	17
Playing your favorite play lists (m3u play list play) (MP3 CD only) ....	17
Playing your favorite tracks by adding Bookmarks (Bookmark track play) .....	18
Playing the 10 tracks you have played most frequently (Auto ranking play) ....	18
Playing tracks you have played most frequently in random order (Auto ranking shuffle play) .....	19

Playing tracks in your favorite order (PGM play) .....	19
Searching for groups or tracks/files .....	20

## **Available features**

Adjusting sound quality (Parametric equalizer) .....	21
The G-PROTECTION function .....	22
Protecting your hearing (AVLS) .....	22
Stopping playback automatically (OFF TIMER) .....	23
Locking the controls (HOLD) .....	23
Turning off the beep sound .....	24
Playing tracks continuously (SEAMLESS) (ATRAC CD only) .....	24

## **Using the radio**

Listening to the radio .....	25
Presetting radio stations .....	27
Playing preset radio stations .....	28
Changing the tuning interval (Except European models) .....	29

## **Connecting to a power source**

Using the dry batteries .....	30
Notes on the power source .....	31

## **Additional information**

List of menus .....	32
Precautions .....	34
Maintenance .....	34
Troubleshooting .....	35
Specifications .....	37
Optional accessories .....	38

# Enjoy your ATRAC CD Walkman!

Thank you for purchasing the D-NF400/NF401. This CD Walkman is called an “ATRAC CD Walkman,” because you can enjoy “ATRAC CDs” on it.

You can make your own ATRAC CD easily.

## How to use the SonicStage

Refer to the supplied booklet “SonicStage.”

1

### Install

Install the supplied “SonicStage” software.



2

### Store and burn

Store music data imported from audio CDs or music files on your PC, select your favorite tracks, then burn your own CDs.

Audio CDs



Music files\*



\*Files in MP3 or WAV format

## What is an ATRAC CD?

An ATRAC CD is a CD-R/RW on which audio data compressed in the ATRAC3plus/ATRAC3 format has been recorded. About 30 audio CDs can be recorded on a CD-R/RW.\* You can also record MP3 files by converting the files to the ATRAC3plus/ATRAC3 format.

\* When total playing time of one CD (album) is estimated at 60 minutes and you are recording on a 700 MB CD-R/RW at 48 kbps in ATRAC3plus format.

## What is the ATRAC3plus/ATRAC3 format?

Refer to pages 7 - 9 of this manual.

Audio data is converted to the ATRAC3plus/ATRAC3 format by the SonicStage.

ATRAC CD



3

## Listen

You can enjoy listening to your own ATRAC CDs on your ATRAC CD Walkman.



You can also enjoy audio CDs on your CD Walkman.

---

## Music sources playable on this CD player

You can play the following 3 music sources on this CD player:

- Audio CDs (CDDA format)
- CDs with ATRAC3plus/ATRAC3 format files (ATRAC CD)
- CDs with MP3 format files (MP3 CD)

### Usable disc formats

You can use ISO 9660 Level 1/2 and Joliet extension format discs only.

### About CD-Rs/RWs

This CD player can play CD-Rs/RWs recorded in the ATRAC3plus/ATRAC3, MP3 or CDDA\* format, but playback capability may vary depending on the quality of the disc and the condition of the recording device.

\* CDDA is the abbreviation for Compact Disc Digital Audio. It is a recording standard used for the Audio CDs.

### Music discs encoded with copyright protection technologies

This product is designed to play back discs that conform to the Compact Disc (CD) standard. Recently, various music discs encoded with copyright protection technologies are marketed by some record companies. Please be aware that among those discs, there are some that do not conform to the CD standard and may not be playable by this product.

#### **Notes**

- This CD player cannot record music content on recordable media, such as CD-Rs/RWs.
- CD-Rs/RWs recorded in the ATRAC3plus/ATRAC3 format cannot be played on your computer.

---

## ATRAC3plus and ATRAC3

“ATRAC3plus,” which stands for “Adaptive Transform Acoustic Coding3plus” is audio compression technology, developed from the ATRAC3 format. Though the ATRAC3plus format can compress music content to about 1/20 of its original size at 64 kbps, you can still enjoy high quality sound. The available transfer bit rates are 256 kbps, 64 kbps and 48 kbps.

“ATRAC3,” which stands for “Adaptive Transform Acoustic Coding3” is audio compression technology that satisfies the demand for high sound quality and high compression rates. The ATRAC3 format can compress music content to about 1/10 of their original size, which contributes to reduction of the media volume. The available transfer bit rates are 132 kbps, 105 kbps and 66 kbps.

The usable number of groups and files

- Maximum number of groups: 255
- Maximum number of files: 999

For details, refer to the supplied booklet “SonicStage.”

### Note on saving files on the media

Do not save files in other formats (except MP3 files) and do not make unnecessary folders on a disc that has ATRAC3plus/ATRAC3 files.

---

## MP3

MP3, which stands for MPEG-1 Audio Layer3, a standard for audio files compression supported by the Motion Picture Experts Group, an ISO (International Organization for Standardization) working group, enables compression of audio files to about 1/10 of the data size of a standard compact disc.

The major specifications of the acceptable disc format are:

- Maximum directory levels: 8
- Acceptable characters: A - Z, a - z, 0 - 9, \_ (underscore)

### Notes

- When naming files, be sure to add the file extension “mp3” to the file name.
- If you add the extension “mp3” to a file other than an MP3 file, the player will not be able to recognize the file properly.

(Continued)

The usable number of groups and files

- Maximum number of groups: 255
- Maximum number of files: 999

Settings for compression and writing software

- This CD player is able to play MP3 files with the following specifications: Bit rate: 16 - 320 kbps, and sampling frequencies: 32/44.1/ 48 kHz. Variable Bit Rate (VBR) file can also be played.  
To compress a source for an MP3 file, we recommend setting the compression software to “44.1 kHz,” “128 kbps,” and “Constant Bit Rate.”
- To record up to the maximum capacity, set to “halting of writing.”
- To record at one time up to the maximum capacity on media that has nothing recorded on it, set to “Disc at Once.”

**Notes on saving files on the media**

- Do not save files in other formats (except MP3/ATRAC3plus/ATRAC3 format files) or unnecessary folders on a disc that has MP3 files.
- When a disc is inserted, the CD player reads all the information of folders and files on that disc. If there are many folders on the disc, it may take a long time for play to begin or for the next file to start playback.

---

## The structure of ATRAC3plus/ATRAC3 and MP3 files

Groups and folders

The ATRAC3plus/ATRAC3 format has a very simple structure. It consists of “files” and “groups.” A “file” is equivalent to a “track” of an audio CD. A “group” is a bundle of files and is equivalent to an “album.” A “group” has no directory-type structure (a new group cannot be made within an existing group).

When referring to MP3 CDs, “file” is equivalent to a “track” and a “group” is equivalent to an “album.” This CD player is designed to recognize an MP3 folder as a “group” so that it can play CD-Rs/RWs in the same manner as it plays ATRAC3plus/ATRAC3 files.



## ATRAC3plus/ATRAC3/MP3 file structure and playing order

### •ATRAC3plus/ATRAC3

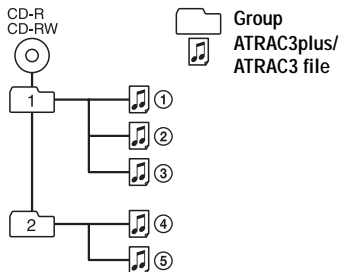

### •MP3

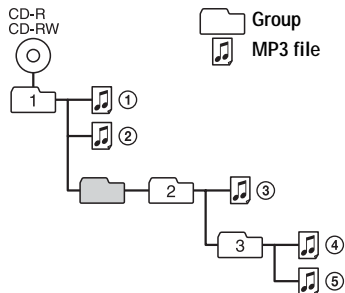

### Notes

- A group that does not include an MP3 file is skipped.
- If ATRAC3plus/ATRAC3 files and MP3 files are recorded on the same CD, this CD player plays the ATRAC3plus/ATRAC3 files first.
- Depending on the method used to record MP3 files on the disc, the playing order may be different from the one shown above.

# Getting started

## Checking the supplied accessories

AC power adaptor (1)  
(not supplied with USA/Canadian models)

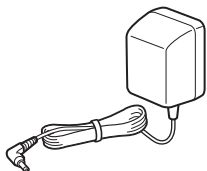

CD-ROM\* (SonicStage) (1)



\*Do not play a CD-ROM on an audio CD player.

User's guide for SonicStage (1)

Headphones (1)  
(for USA model)



Earphones (1)  
(for other models)

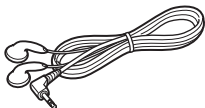

# Locating the controls

## CD player

For details, see the pages in parentheses.

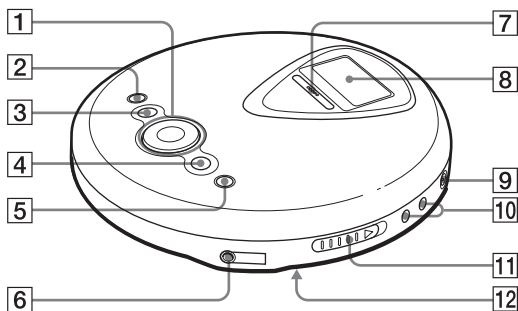

- 1** Operation button (13, 14, 16 - 26, 28, 29, 32)

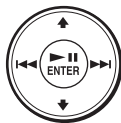

**▶▶**\*1/ENTER: play/pause/enter

**◀◀**: AMS\*2/rewind/tune in a preset station

**▶▶**: AMS/fast forward/tune in a preset station

**▲**/**▼**: Use to select a file, play mode, etc.

- 2** **■** (stop)•RADIO OFF button (20, 22, 23, 25, 28, 32)

- 3** **⏮** (group) -•TUNE - button (14, 19, 20, 22, 23, 25, 28, 32)

- 4** **⏭** (group) +•TUNE + button (14, 19, 20, 25, 28)

- 5** DISPLAY/MENU button (15, 16, 19 - 29, 32)

Use to enter the menu. Also use to enter the selection as well as **▶▶**/ENTER.

- 6** **🎧** (headphones) jack (13)

- 7** RADIO ON/BAND•MEMORY button (25 - 28)

RADIO ON: Press to turn on the radio.

BAND: Press to change the band.

MEMORY: Press and hold to preset stations.

- 8** Display (12, 15 - 17, 19 - 21, 25 - 27, 32)

- 9** DC IN 4.5 V (external power input) jack (13)

- 10** VOL (volume) +\*1/- buttons (13)

- 11** OPEN switch (13, 30)

Slide the switch to open the CD player lid.

- 12** HOLD switch (rear) (23)

Slide the switch in the direction of the arrow to disable the buttons on the CD player.

\*1 The button has a tactile dot.



\*2 Automatic Music Sensor

(Continued)

## Display

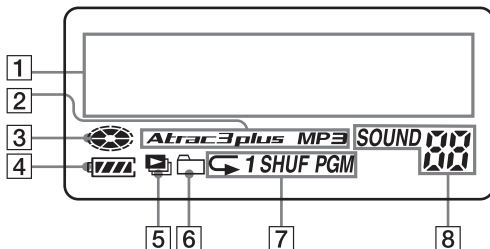
For details, see the pages in parentheses.



- 1** Character information display (15)  
While playing an audio CD, disc name, track name, etc. appear in the 2 lines, if recorded on the CD.  
While playing an ATRAC CD/MP3 CD, group name, file name, etc. appear in the 2 lines, if recorded on the CD.  
Menu items also appear in this display.
- 2** Atrac3plus/MP3 indication
- 3** Disc indication  
Lights up while the CD player is playing.
- 4** Battery indication (30)  
Roughly shows the remaining power of the battery. If “” flashes, the batteries are depleted.
- 5** Play list indication  
For MP3 CD only
- 6** Group indication (19, 20)  
For ATRAC CD/MP3 CD only
- 7** Play mode indication  
Shows various playmodes such as shuffle play and program play. “” shows repeat play.
- 8** SOUND indication  
Shows the SOUND setting which has been selected on the menu.

# Playing a CD

## 1. Insert a CD.

- 1 Slide OPEN to open the CD player lid.

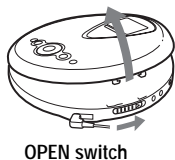

- 2 Place the CD on the tray and close the lid.

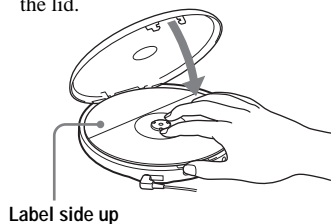

## 2. Connect your CD player.

You can use the following power sources:

- LR6 (size AA) alkaline batteries (page 30)
- AC power adaptor

We explain how to use your CD player on house current on this page. Connect the plugs securely.

- 1 Connect the AC power adaptor.
- 2 Connect the headphones/earphones to the CD player.

## 3. Play a CD.

Press ►||/ENTER.



Adjust the volume by pressing VOL + or -.

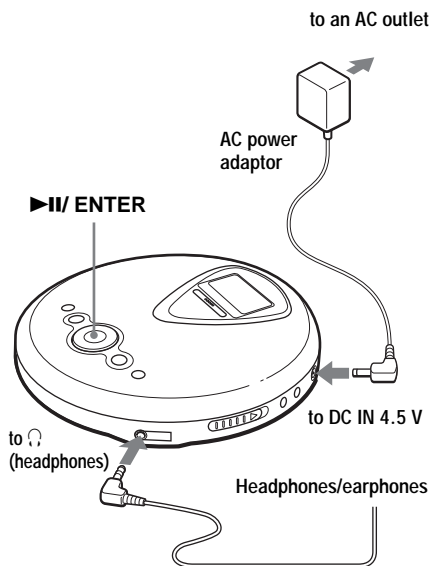

(Continued)

## Basic operations

To	Do this
Play (from a point where you stopped previously)	Press ►►/ ENTER. Playback starts from the point where you stopped.
Play (from the first track)	While the CD player is stopped, press and hold ►►/ ENTER until the play of the first track starts.
Pause/resume play after pause	Press ►►/ ENTER.
Stop*2	Press ■.
Find the beginning of the current track (AMS*1)*2	Press ◀◀.
Find the beginning of previous tracks (AMS)*3	Press ◀◀ repeatedly.
Find the beginning of the next track (AMS)*2, *3	Press ►►.
Find the beginning of succeeding tracks (AMS)*3	Press ►► repeatedly.
Go backwards quickly*2, *5	Press and hold ◀◀.
Go forward quickly*2, *5	Press and hold ►►.
Jump to succeeding groups*4	Press ◻ + repeatedly.
Jump to previous groups*4	Press ◻ - repeatedly.

\*1 Automatic Music Sensor

\*2 These operations can be carried out during both play and pause.

\*3 After you have played the last track, you can return to the beginning of the first track by pressing ►►.  
Similarly, if you are at the first track, you can locate the last track by pressing ◀◀.

\*4 Only when you play an ATRAC CD/MP3 CD

\*5 These operations cannot be carried out when using an MP3 file recorded on a CD-R/RW in a packet write format.

## Checking CD information on the display

You can check CD information by pressing DISPLAY/MENU repeatedly.

When you are playing a CD containing text information such as CD-TEXT, “track name,” “album name,” “artist name,” etc. are displayed as shown in parentheses in the following table.

When you are playing an ATRAC CD, information you input using the SonicStage software is displayed. When you are playing an MP3 CD containing MP3 files with an ID3 tag\*1, ID3 tag information is displayed.

Each time you press DISPLAY/MENU, the display changes as follows:

Screen	Audio CD	ATRAC CD/MP3 CD
1	Track number, elapsed playing time, (Track name)	File name, file number, elapsed playing time
2	Track number, remaining time of the current track (Track name, artist name)	Artist name, CODEC information*3, file number, remaining time of the current file
3	The number of tracks left*2, the time remaining on the CD*2 (Album name, artist name)	Group name, total number of files
4	List of track names	List of group names/file names

\*1 An ID3 tag is a format for adding certain information (track name, album name, artist name, etc.) to MP3 files. This CD player conforms to Version 1.1/2.2/2.3 of the ID3 tag format (MP3 files only).

\*2 Not displayed during Single play, Shuffle play, Bookmark track play, Auto ranking play, Auto ranking shuffle play or PGM play.

\*3 Bit rate and sampling frequencies. While an MP3 file made at VBR (variable bit rate) is being played, “VBR” appears on the display instead of a bit rate. In some cases, “VBR” appears halfway through playback, not from the beginning.

### Notes

- The characters A - Z, a - z, 0 - 9, and \_ can be displayed on this CD player.
- Before playing a file, the CD player reads all file and group (or folder) information on the CD. “READING” is displayed. Depending on the content of the CD, it may take some time to accomplish this reading.
- If the group does not have a group name, “ROOT” appears in the display.
- If the file does not have ID3 tag information, “- - -” appears in the display.

## Removing the CD

Remove the CD while pressing the pivot in the center of the tray.

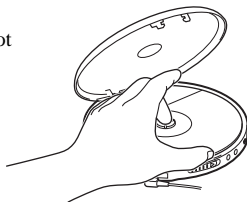

## ► Playback options

You can enjoy the following playback options using the menu function.

- **Playing tracks repeatedly (Repeat play)**
- **Playing all files in a selected group (Group play)**
- **Playing a single track (Single play)**
- **Playing tracks in random order (Shuffle play)**
- **Playing all files in a selected group in random order (Group shuffle play)**
- **Playing your favorite play lists (m3u play list play)**
- **Playing your favorite tracks by adding Bookmarks (Bookmark track play)**
- **Playing the 10 tracks you have played most frequently (Auto ranking play)**
- **Playing tracks you have played most frequently in random order (Auto ranking shuffle play)**
- **Playing tracks in your favorite order (PGM play)**

### Selecting playback options

Enter the PLAY MODE menu using the following procedures, then select each playback option.

- 1 Press and hold DISPLAY/MENU until the MENU screen appears.

```
MENU
>REPEAT
```

- 2 Press **▲** or **▼** to select "PLAY MODE," then press **▶II/ENTER**\*

\* You can also use DISPLAY/MENU to enter the selection, instead of **▶II/ENTER**.

```
MENU
>PLAY MODE
```

- 3 Press **▲** or **▼** to select the playback option you want.  
The default setting is "ALL" (normal play).

```
PLAY MODE
>GROUP
```

Playback options appear.

---

## Playing tracks repeatedly (Repeat play)

You can repeat various playback options.

- 1 Press and hold DISPLAY/MENU until the MENU screen appears.

```
MENU
>REPEAT
```

- 2 Press **▲** or **▼** to select "REPEAT," then press **▶II/ENTER**.
- 3 Press **▲** or **▼** to select "ON," then press **▶II/ENTER** to enter the selection.

```
REPEAT
>ON
```

---

## Playing all files in a selected group (Group play) (ATRAC CD/MP3 CD only)

Perform steps 1 and 2 of "Selecting playback options" (this page), press **▲** or **▼** to select "GROUP," then press **▶II/ENTER** to enter the selection.

---



---

## Playing a single track (Single play)

---

Perform steps 1 and 2 of “Selecting playback options” (page 16), press **↑** or **↓** to select “1,” then press **▶II/ENTER** to enter the selection.

---

---

## Playing tracks in random order (Shuffle play)

---

Perform steps 1 and 2 of “Selecting playback options” (page 16), press **↑** or **↓** to select “SHUFFLE,” then press **▶II/ENTER** to enter the selection.

---

---

## Playing all files in a selected group in random order (Group shuffle play) (ATRAC CD/MP3 CD only)

---

Perform steps 1 and 2 of “Selecting playback options” (page 16), press **↑** or **↓** to select “GROUP SHUF,” then press **▶II/ENTER** to enter the selection.

---

---

## Playing your favorite play lists (m3u play list play) (MP3 CD only)

You can play your favorite m3u play lists.\*  
\* An “m3u play list” is a file for which an MP3 file playing order has been encoded. To use the play list function, record MP3 files on a CD-R/RW using encoding software that supports the m3u format.

---

**1** Perform steps 1 and 2 of “Selecting playback options” (page 16), press **↑** or **↓** to select “PLAY LIST,” then press **▶II/ENTER** to enter the selection.

**2** Press **↑** or **↓** to select a play list.



```
PLAY LIST
>LATEST
```

Play list

**3** Press **▶II/ENTER**.

---

---

## Playing your favorite tracks by adding Bookmarks

### (Bookmark track play)



While the CD player is playing, you can add bookmarks to the tracks you want and play them only.

Audio CD: up to 99 tracks for each CD (up to 10 CDs)

ATRAC CD: up to 999 tracks for each CD (up to 5 CDs)

MP3 CD: up to 999 tracks for each CD (up to 5 CDs)

### Adding Bookmarks\*

- 1 During play of the track to where you want to add a Bookmark, press and hold **▶||/ENTER** until “” disappears and “” (Bookmark) flashes instead. When the Bookmark has been added successfully, “” flashes slower.
- 2 Press **◀◀** or **▶▶** to select the track to where you want to add a Bookmark, then repeat step 1 to add Bookmarks to the tracks you want.

### Playing the tracks with Bookmarks

Perform steps 1 and 2 of “Selecting playback options” (page 16), press **▲** or **▼** to select “BOOK MARK,” then press **▶||/ENTER**.

The play of the tracks with the Bookmarks starts.

### To remove the Bookmarks\*

During play of the track with a Bookmark, press and hold **▶||/ENTER** until “” disappears from the display.

### To check the tracks with Bookmarks\*

During playback of the tracks with Bookmarks, “” lights up in the display.

\* Perform these operations only when Screen 1 is displayed (page 15).

### Notes

- During play of tracks with Bookmarks, tracks are played in order of track number, and not in the order you added the Bookmarks.
- If you try to add Bookmarks to the tracks on the 11th CD (on a 6th CD when playing ATRAC CDs/MP3 CDs), the Bookmarks of the CD you played first will be erased.
- If you remove all power sources, all Bookmarks stored in memory will be erased.

---

## Playing the 10 tracks you have played most frequently (Auto ranking play)

The CD player automatically memorizes up to 10 tracks you have played most frequently from the CD being played, and plays them from the 10th to the top.

---

**Perform steps 1 and 2 of “Selecting playback options” (page 16), press **▲** or **▼** to select “AUTO RANKING,” then press **▶||/ENTER** to enter the selection.**

---

## Playing tracks you have played most frequently in random order (Auto ranking shuffle play)

The CD player plays up to 32 tracks which the player has automatically memorized as the most frequently played ones. In Auto ranking shuffle play, these tracks are played in random order.

**Perform steps 1 and 2 of “Selecting playback options” (page 16), press  $\uparrow$  or  $\downarrow$  to select “RANKING SHUF,” then press  $\blacktriangleright$ /II/ENTER to enter the selection.**

### Note

The CD player memorizes the tracks you have played from up to 10 CDs, whether you have changed the CDs or not. If the CD player tries to memorize tracks from an 11th CD, the data memorized first will be erased.

## Playing tracks in your favorite order (PGM play)

You can program the CD player to play up to 64 tracks in your favorite order.

- 1 While play is stopped, perform steps 1 and 2 of “Selecting playback options” (page 16), press  $\uparrow$  or  $\downarrow$  to select “PROGRAM,” then press  $\blacktriangleright$ /II/ENTER to enter the selection.**
- 2 Press  $\blacktriangleleft\blacktriangleleft$  or  $\blacktriangleright\blacktriangleright$  to select the track and press DISPLAY/MENU to enter the selection.**

The track has been stored in memory. When playing an ATRAC CD/MP3 CD, you can also select a group using  $\square +$  or  $\square -$ .

[Audio CD]



Track number    Playing order

[CD-TEXT]

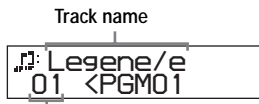

Track number

[ATRAC CD/MP3 CD]



Playing order    File name

(Continued)

---

Playing tracks in your favorite order

---

**3 Repeat step 2 to select the tracks in your favorite order.**

---

**4 Press ►II/ENTER to start PGM play.**

---

Checking the program

**While programming:**

Press DISPLAY/MENU repeatedly before step 4.

**Notes**

- When you finish entering the 64th track in step 3, the first selected track number (audio CD) or the first selected file name (ATRAC CD/MP3 CD) appears on the display.
- If you select 65 tracks or more, the first selected tracks are erased.

---

## Searching for groups or tracks/files

While the CD player is playing, you can search for and play the group (ATRAC CD only) or track/file you want quickly using **▲** or **▼** on the CD player.

---

**1 During play, press ▲ or ▼ until the search screen appears.**



---

**2 Press **◁** + or **▷** - to select the group you want, then press **►II/ENTER**.**

The CD player starts playing from the first file in the group you selected.

---

Selecting the track/file you want

**1** Perform step 1 above, then press **◁** + or **▷** - to select the group you want.

**2** Press **▲** or **▼** to select the track/file you want, then press **►II/ENTER**.

The CD player starts playing from the track/ file you selected.

---

**To exit the search mode**

Press **■**. If about 40 seconds at most have passed without any operation being performed, the screen returns to the previous one.

## Adjusting sound quality (Parametric equalizer)

You can enjoy your favorite sounds by adjusting sound quality in the following two ways:

- Selecting a preset sound pattern → “Selecting the sound quality you want”
- Adjusting sound quality by yourself → “Customizing sound quality”

### Selecting the sound quality you want

- 1 Press DISPLAY/MENU until the MENU screen appears.
- 2 Press  $\uparrow$  or  $\downarrow$  to select “SOUND,” then press  $\blacktriangleright$ /ENTER\*.
- \* You can also use DISPLAY/MENU to enter the selection as well as  $\blacktriangleright$ /ENTER.
- 3 Press  $\uparrow$  or  $\downarrow$  to select the sound quality you want, then press  $\blacktriangleright$ /ENTER to enter the selection.

Indication	Sound quality
SOFT	For vocals, stressing middle range audio
ACTIVE	Lively sounds, emphasizing high and low range audio
HEAVY	Powerful sounds, further emphasizing high and low ranges compared with ACTIVE sound
CUSTOM	Customized sound

### Customizing sound quality

You can customize sound quality by adjusting the sound volume in the 3 frequency ranges “LOW” (low range audio), “MID” (middle range audio) and “HIGH” (high range audio). For each frequency range, you can select the wave pattern from among 3 patterns, and can also adjust the sound volume in 7 levels for the pattern you select.

Adjust sound quality by checking the shape of the wave on the display.

- 1 Perform steps 1 - 3 of “Selecting the sound quality you want” and select “CUSTOM.”

- 2 Press  $\blacktriangleleft$  or  $\blacktriangleright$  for 2 seconds or more to select the frequency range.

The frequency range you selected flashes.



- 3 Press  $\uparrow$  or  $\downarrow$  to select the sound volume, then press  $\blacktriangleleft$  or  $\blacktriangleright$  repeatedly to select the shape of the wave from the 3 shapes stored in memory for each frequency range.

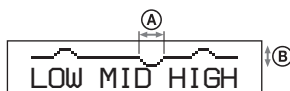

- (A): Frequency range  
(B): Sound volume

- 4 Repeat steps 2 and 3 to make adjustment for the remaining 2 frequency ranges.
- 5 Press  $\blacktriangleright$ /ENTER to enter the selection.

(Continued)

---

## Adjusting sound quality

### To return to the previous screen

Press -.

### To cancel the adjustment operation

Press .

#### Notes

- When you select CUSTOM sound, sound may be distorted depending on your sound settings when you turn up the volume. If this happens, turn the volume down.
- You may feel a difference in sound volume between the CUSTOM sound setting and other sound settings. Adjust the volume for your preference.
- When using the radio, the parametric equalizer function does not work.

---

## The G-PROTECTION function

The G-PROTECTION function has been developed to provide excellent protection against sound skipping during many active uses.

---

**1** While play is stopped, press and hold **DISPLAY/MENU** until the **MENU** screen appears. Press **↑** or **↓** to select “**OPTION**,” then press **▶II/ENTER**.

---

**2** Press **↑** or **↓** to select “**G-PROTECTION**,” then press **▶II/ENTER** to enter the selection.

---

**3** Press **↑** or **↓** to select “**G-PRO 1**” or “**G-PRO 2**,” then press **▶II/ENTER** to enter the selection.

If you select “**G-PRO 2**,” the G-PROTECTION function will be enhanced compared to “**G-PRO 1**.” To enjoy high quality CD sound, select “**G-PRO 1**.”

#### Note

Sound may skip:

- if the CD player receives stronger continuous shock than expected,
- if a dirty or scratched CD is played, or
- when using poor-quality CD-Rs/RWs or if there is a problem with the original recording device or application software.

---

## Protecting your hearing (AVLS)

The AVLS (Automatic Volume Limiter System) function keeps the maximum volume down to protect your hearing.

---

**1** Press and hold **DISPLAY/MENU** until the **MENU** screen appears. Press **↑** or **↓** to select “**OPTION**,” then press **▶II/ENTER**.

---

**2** Press **↑** or **↓** to select “**AVLS**,” then press **▶II/ENTER** to enter the selection.

---

**3** Press **↑** or **↓** to select “**ON**,” then press **▶II/ENTER** to enter the selection.

---

### To cancel the AVLS function

Perform steps 1 - 3, changing the AVLS setting to “**OFF**.”

---

## Stopping playback automatically (OFF TIMER)

You can set the CD player to stop the play automatically within a range of 1 to 99 minutes. While the timer function is working, “⏸” appears at about 5 second intervals\*.

\* Only when Screen 1 or 2 is displayed (page 15)

---

**1** Press and hold **DISPLAY/MENU** until the **MENU** screen appears. Press **↑** or **↓** to select “**OPTION**,” then press **▶II/ENTER**.

---

**2** Press **↑** or **↓** to select “**TIMER**,” then press **▶II/ENTER** to enter the selection.

---

**3** Press **↑** or **↓** to select “**10 min\***,” then press **▶II/ENTER**.

\* Default setting. If you have changed the setting, the length of time already set appears.

---

**4** Press **↑** or **↓** to select the length of time you want to set from “**01 min**” to “**99 min**,” then press **▶II/ENTER** to enter the selection.

- To increase/decrease by 5 minutes: Press **↑** or **↓** repeatedly.
- To increase/decrease by 1 minute: Press **↑** or **↓** for 2 seconds or more.

---

### To return to the previous screen

Press **□** -.

### To cancel the setting operation

Press **■**.

### To check the length of time before the CD player stops playback

During play, perform steps 1 - 3.

### To cancel the OFF TIMER function

The OFF TIMER function will be canceled:

- When you perform steps 1 - 3, changing the OFF TIMER setting to “OFF.”
- When you listen to the radio.

---

## Locking the controls (HOLD)

You can lock the controls on your CD player to prevent accidental button presses.

---

### Slide HOLD in the direction of the arrow.

“HOLD” flashes if you press any button when the HOLD function is activated.

---

### To unlock the controls

Slide HOLD in the direction opposite to that of the arrow.

---

## Turning off the beep sound

You can turn off the beep sound that is heard from your headphones/earphones when you operate your CD player.

- 1** Press and hold **DISPLAY/MENU** until the **MENU** screen appears. Press **↑** or **↓** to select “**OPTION**,” then press **▶II/ENTER**.
- 2** Press **↑** or **↓** to select “**BEEP**,” then press **▶II/ENTER** to enter the selection.
- 3** Press **↑** or **↓** to select “**OFF**,” then press **▶II/ENTER** to enter the selection.

---

### To turn on the beep sound

Perform steps 1 - 3, changing the **BEEP** setting to “**ON**.”

---

## Playing tracks continuously (**SEAMLESS**) (**ATRAC CD only**)

You can play live concert music, etc. without space between the tracks.

- 1** While play is stopped, press and hold **DISPLAY/MENU** until the **MENU** screen appears. Press **↑** or **↓** to select “**OPTION**,” then press **▶II/ENTER**.
- 2** Press **↑** or **↓** to select “**SEAMLESS**,” then press **▶II/ENTER** to enter the selection.
- 3** Press **↑** or **↓** to select “**ON**,” then press **▶II/ENTER** to enter the selection.

---

### **Note**

The tracks may not play continuously depending on how the source music was recorded.



## Listening to the radio

You can enjoy FM and AM programs.

**1 Press RADIO ON/BAND to turn on the radio.**

**2 Press RADIO ON/BAND until the band you want appears.**

Each time you press the button, the display changes as follows:

USA and Canadian models:

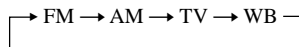

Other models:

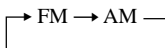

**3 Press TUNE + or - to tune in the station you want and adjust the volume.**

### Turning off the radio

Press **■•RADIO OFF**.

### Tuning in the station quickly

Hold down TUNE + or - in step 3 until the frequency digits begin to change in the display. The CD player automatically scans the radio frequencies and stops when it finds a clear station.

### Improving broadcast reception

For FM, extend the headphones/earphones cord.

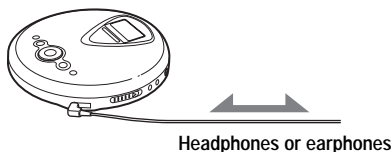

For AM, reorient the CD player itself.

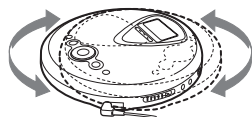

### Note

Keep the headphones/earphones connected to the  jack of the CD player. The headphones/earphones cord works as the FM antenna.

If it is hard to hear the FM/TV/WB broadcast (for U, CA, E92, MX2\* models)

- 1 While listening to the radio, press and hold DISPLAY/MENU until the display changes.



- 2 Press **▲** or **▼** to select "LOCAL," then press **▶||/ENTER**.
- 3 Press **▲** or **▼** to select "ON," then press **▶||/ENTER** to enter the selection.

\* For the area code of the model you purchased, check the upper left side of the bar code on the package.

(Continued)

## Listening to the radio

If it is hard to hear the FM broadcast (for CED, CEK, EE1, E13, AU2, E13/2\* models)

- 1 While listening to the radio, press and hold DISPLAY/MENU until the display changes.

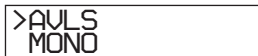

- 2 Press  $\uparrow$  or  $\downarrow$  to select "MONO," then press  $\blacktriangleright$ /ENTER.
- 3 Press  $\uparrow$  or  $\downarrow$  to select "ON," then press  $\blacktriangleright$ /ENTER to enter the selection.

The noise will be reduced but the radio will play in monaural.

\* For the area code of the model you purchased, check the upper left side of the bar code on the package.

## Protecting your hearing

The AVLS (Automatic Volume Limiter System) function keeps the maximum volume down to protect your hearing.

- 1 While listening to the radio, press and hold DISPLAY/MENU until the display changes.
- 2 Press  $\uparrow$  or  $\downarrow$  to select "AVLS," then press  $\blacktriangleright$ /ENTER.
- 3 Press  $\uparrow$  or  $\downarrow$  to select "ON," then press  $\blacktriangleright$ /ENTER to enter the selection.

### To cancel the AVLS function

Perform steps 1 - 3, changing the AVLS setting to "OFF."

## Turning off the radio automatically

You can set the radio to turn off automatically within a range of 10 to 99 minutes by 10 minutes. While the timer function is working, "⌚" appears at about 5 second intervals.

- 1 While listening to the radio, press and hold DISPLAY/MENU until the display changes.
- 2 Press  $\uparrow$  or  $\downarrow$  to select "TIMER," then press  $\blacktriangleright$ /ENTER.
- 3 Press  $\uparrow$  or  $\downarrow$  to select the length of time you want to set from "10" to "99," then press  $\blacktriangleright$ /ENTER to enter the selection.

### To check the length of time before the radio is automatically turned off

During play, perform steps 1 - 2.

### To cancel the OFF TIMER function

The OFF TIMER function for the radio will be canceled:

- When you perform steps 1 - 3, changing the OFF TIMER setting to "OFF."
- When you turn off the radio.
- When you start playing a CD.

## When listening to the radio on batteries

If you connect the external power source plug to the DC IN 4.5 V jack of your CD player, the CD player will turn off. Turn it on by pressing RADIO ON/BAND to continue listening to it.

---

## Presetting radio stations

You can preset up to 51 stations (for USA and Canadian models) : 7 for TV, 4 for WB, 30 for FM and 10 for AM or 40 stations (for other models) : 30 for FM and 10 for AM.

---

**1 Press RADIO ON/BAND to turn on the radio.**

---

**2 Press RADIO ON/BAND to select the band.**

---

**3 Press MEMORY for 2 seconds or more.**

The preset number will flash in the display.

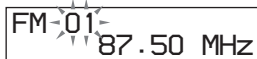

---

**4 Press DISPLAY/MENU for 2 seconds or more.**

The CD player starts scanning the stations from the lower frequencies and stops for about 3 seconds when a station is received.

---

**5 If you want to preset the received station, press DISPLAY/MENU while the preset number is flashing.**

The received station is preset on the preset number 1 and the CD player starts scanning for the next receivable station. If you do not press DISPLAY/MENU within the 3 seconds, the CD player will start scanning for the next receivable station without storing the station.

---

**6 Repeat step 5 until all receivable stations are preset.**

If the stations have already been stored, the newly preset stations will replace the old ones.

---

### Presetting stations manually

- 1 Press RADIO ON/BAND to turn on the radio.
- 2 Press RADIO ON/BAND to select the band.
- 3 Press and hold MEMORY until the preset number flashes in the display.

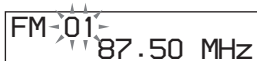

From this step on, start the next operation within 30 seconds after you finished the previous operation. If 30 seconds pass with nothing done, the preset number stops flashing which shows that the CD player has exited the preset memory standby mode. If this happens, start from step 3 again.

(Continued)

---

## Presetting radio stations

- 4 Press **◀◀** or **▶▶** repeatedly to select the preset number you want to store the station on while the preset number flashes.
- 5 Press **TUNE +** or **-** to tune in the station you want while the preset number flashes.
- 6 Press **DISPLAY/MENU**.  
When the station is preset successfully, the beep sounds. The new station replaces the old one.  
The preset number increases by one and the CD player enters the preset memory standby mode.
- 7 Repeat steps 4 to 6 when you preset the stations in the same band. When you preset the stations in the different band, press and hold **MEMORY** to exit the preset memory standby mode. Repeat steps 2 to 6 after the preset number stops flashing.

### To exit the preset memory standby mode

When the radio is turned on, you can exit the preset memory standby mode using one of the following procedures. Preset stations, however, will remain stored in the CD player's memory.

- Hold down **MEMORY** until the preset number stops flashing.
- Do not press any button for 30 seconds. The preset number stops flashing.
- Press **▶||**. The CD player enters the CD playing mode.
- Press **■•RADIO OFF**. The radio turns off.

### To cancel all preset stations

- 1 While the radio is turned off and CD play is stopped, press and hold **DISPLAY/MENU** until the **MENU** screen appears.
- 2 Press **▲** or **▼** to select "OPTION," then press **▶||/ENTER**.
- 3 Press **▲** or **▼** to select "TUNER PRESET," then press **▶||/ENTER** to enter the selection.  
"Clear?" appears in the display. When you press **▶||/ENTER**, all the preset stations are canceled.

---

## Playing preset radio stations

You can tune in the station easily by pressing **◀◀** or **▶▶** button.

- 1 Press **RADIO ON/BAND** to select the band.
  - 2 Press **◀◀** or **▶▶** to tune in a stored station.
-

---

## Changing the tuning interval (Except European models)

When using the CD player abroad, change the AM tuning interval on the menu, if necessary.

9 kHz area: Asia and Europe

10 kHz area: the U.S.A., Canada and South America

Change it while the radio is turned off and CD play is stopped, as follows.

- 
- 1** Press and hold **DISPLAY/MENU** until the **MENU** screen appears.

---

  - 2** Press **↑** or **↓** to select “**OPTION**,” then press **▶II/ENTER**.

---

  - 3** Press **↑** or **↓** to select “**AM STEP**,” then press **▶II/ENTER** to enter the selection.

---

  - 4** Press **↑** or **↓** to select “**9 kHz**” or “**10 kHz**,” then press **▶II/ENTER** to enter the selection.
- 

**Note**

After changing the tuning interval, you need to preset radio stations again.

## Using the dry batteries

Use only the following dry battery type for your CD player:

- LR6 (size AA) alkaline batteries

For the battery life, see “Specifications.”

### Note

Be sure to remove the AC power adaptor when using the dry batteries.

- 1 Slide OPEN to open the lid of your CD player, then open the battery compartment lid inside the player.**

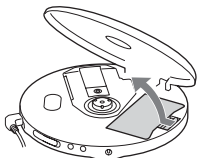

- 2 Insert two LR6 (size AA) batteries by matching the ⊕ to the diagram in the battery compartment and close the lid until it clicks into place.**

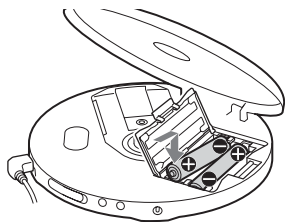

Insert the ⊖ end first  
(for both batteries).

## When to replace the batteries

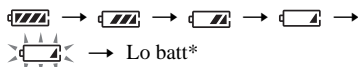

You can check the remaining power of the batteries in the display.



\* Beep sounds.

When the batteries are depleted, replace both batteries with new ones.

### Notes

- The indicator sections of  roughly show the remaining battery power. One section does not always indicate one-fourth of the battery power.
- Depending on operating conditions, the indicator sections of  may increase or decrease.

## To remove the batteries

Remove the batteries as illustrated below.

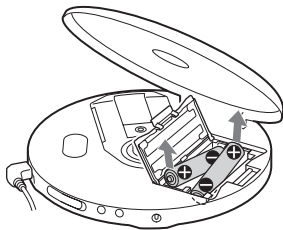

## To attach the battery compartment lid

If the battery compartment lid is detached by an accidental drop, excessive force, etc., attach it as illustrated below.

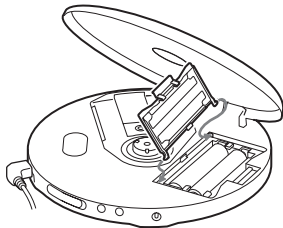

---

## Notes on the power source

Disconnect all power sources when the CD player is not used for a long time.

### On AC power adaptor

- Use only the AC power adaptor supplied. If your CD player is not supplied with the one, use the AC-E45HG AC power adaptor. Do not use any other AC power adaptor. It may cause a malfunction.

#### Polarity of the plug





- Do not touch the AC power adaptor with wet hands.
- Connect the AC power adaptor to an easily accessible AC outlet. Should you notice an abnormality in the AC power adaptor, disconnect it from the AC outlet immediately.

### On dry batteries

- Do not throw the batteries into fire.
- Do not carry the batteries with coins or other metallic objects. It can generate heat if the positive and negative terminals of the battery are accidentally contacted by a metallic object.
- Do not mix new batteries with old ones.
- Do not use different types of batteries together.
- When the batteries are not to be used for a long time, remove them.
- If battery leakage occurs, wipe off any deposit in the battery compartment, and install new batteries. In case the deposit adheres to you, wash it off thoroughly.

## List of menus

Press and hold DISPLAY/MENU until the MENU screen appears, then press  or  to select the menu you want.



To return to the previous screen, press  <sup>\*1</sup>.

To cancel the setting operation, press .

Items marked  are default settings.

Setting playback options (page)	Menu 1	➔	Menu 2
Playing tracks repeatedly (16)	REPEAT		 OFF ON
Normal play	PLAY MODE		ALL
Playing all files in a selected group (16)	PLAY MODE		GROUP* <sup>2</sup>
Playing a single track (17)	PLAY MODE		1
Playing track in random order (17)	PLAY MODE		SHUFFLE
Playing all files in a selected group in random order (17)	PLAY MODE		GROUP SHUF* <sup>2</sup>
Playing your favorite tracks by adding Bookmarks (18)	PLAY MODE		BOOK MARK* <sup>3</sup>
Playing your favorite play lists (17)	PLAY MODE		PLAY LIST* <sup>4</sup>
Playing the 10 tracks you have played most frequently (18)	PLAY MODE		AUTO RANKING
Playing tracks you have played most frequently in random order (19)	PLAY MODE		RANKING SHUF
Playing tracks in your favorite order (19)	PLAY MODE		PROGRAM* <sup>5</sup>

\*1 When "PGM" is not displayed.

\*2 For ATRAC CD/MP3 CD only

\*3 Only when Bookmarks have been added to the tracks/files

\*4 Play lists (m3u) recorded in MP3 format only

\*5 You can make this setting while play is stopped.



Setting of sound (page)	Menu 1 →	Menu 2 →	Menu 3
Adjusting sound quality (21)	SOUND	● OFF SOFT ACTIVE HEAVY CUSTOM	—
Setting various functions (page)	Menu 1 →	Menu 2 →	Menu 3
Protecting against sound skipping (22)	OPTION	G-PROTECTION*1	● G-PRO 1 G-PRO 2
Protecting your hearing (22)	OPTION	AVLS	ON ● OFF
Stopping playback automatically (23)	OPTION	TIMER	10 min*2 ● OFF
Turning off the beep sound (24)	OPTION	BEEP	● ON OFF
Playing tracks continuously (24)	OPTION	SEAMLESS*1, *3	ON ● OFF
Setting when the radio is turned off (page)	Menu 1 →	Menu 2 →	Menu 3
Changing the tuning interval (29)	OPTION	AM STEP	9 kHz*4 10 kHz
Canceling all preset stations (28)	OPTION	TUNER PRESET	Clear?

\*1 You can make these settings while play is stopped.

\*2 Default setting. If you have changed the setting, the length of time already set appears.

\*3 For ATRAC CD only

\*4 Default settings vary for each area you purchased the CD player.

---

## Precautions

### On safety

- Should any solid objects or liquid fall into the CD player, unplug it and have it checked by qualified personnel before operating it any further.
- Do not put any foreign objects in the DC IN 4.5 V (external power input) jack.

### On the CD player

- Keep the lens on the CD player clean and do not touch it. If you do so, the lens may be damaged and the CD player will not operate properly.
- Do not put any heavy object on top of the CD player. The CD player and the CD may be damaged.
- Do not leave the CD player in a location near heat sources, or in a place subject to direct sunlight, excessive dust or sand, moisture, rain, mechanical shock, unlevelled surface, or in a car with its windows closed.
- If the CD player causes interference to the radio or television reception, turn off the CD player or move it away from the radio or television.
- Discs with non-standard shapes (e.g., heart, square, star) cannot be played on this CD player. Attempting to do so may damage the CD player. Do not use such discs.

### On handling CDs

- To keep the CD clean, handle it by its edge. Do not touch the surface.
- Do not stick paper or tape onto the CD.
- Do not expose the CD to direct sunlight or heat sources such as hot air ducts. Do not leave the CD in a car parked under direct sunlight.

### On headphones/earphones

#### Road safety

Do not use headphones/earphones while driving, cycling, or operating any motorized vehicle. It may create a traffic hazard and is illegal in some areas. It can also be potentially dangerous to play your headsets at high volume while walking, especially at pedestrian crossings. You should exercise extreme caution or discontinue use in potentially hazardous situations.

#### Preventing hearing damage

Avoid using headphones/earphones at high volume. Hearing experts advise against continuous, loud and extended play. If you experience a ringing in your ears, reduce volume or discontinue use.

#### Consideration for others

Keep the volume at a moderate level. This will allow you to hear outside sounds and to be considerate to the people around you.

---

## Maintenance

### To clean the casing

Use a soft cloth slightly moistened in water or a mild detergent solution. Do not use alcohol, benzine or thinner.

# Troubleshooting

Should any problem persist after you have checked these symptoms, consult your nearest Sony dealer.

## CD player

Symptom	Cause and/or corrective action
The volume does not increase even if you press VOL + repeatedly.	→ AVLS is set to "ON." Set it to "OFF." (page 22)
No sound, or noise is heard.	→ Connect the headphones/earphones plugs firmly. (page 13) → Plugs are dirty. Clean the headphones/earphones plugs with a dry soft cloth periodically.
Certain files cannot be played.	→ You tried to play files saved in a format that is not compatible with this CD player. (page 6)
The playing time is too short when powered with the dry batteries.	→ Check that you are using alkaline batteries and not manganese batteries. (page 30) → Replace the batteries with new LR6 (size AA) alkaline batteries. (page 30)
"Lo batt" appears on the display. The CD does not play.	→ Replace the batteries with new LR6 (size AA) alkaline batteries. (page 30)
"Hi dc In" appears on the display.	→ An AC power adaptor which is rated higher than the one supplied or recommended is being used. Use only the supplied AC power adaptor or the car battery cord recommended in "Optional accessories". (page 38)
The CD does not play or "No disc" appears on the display when a CD is placed in the CD player.	→ The CD is dirty or defective. → Check that the CD is inserted with the label side up. (page 13) → Moisture condensation has occurred. Leave the CD player aside for several hours until the moisture evaporates. → Close the lid of the battery compartment firmly. (page 30) → Make sure the batteries are inserted correctly. (page 30) → Connect the AC power adaptor to an AC outlet securely. (page 13) → Press ►  /ENTER after one second or more has passed since the AC power adaptor was connected. → The CD-R/RW is blank. → There is a problem with the quality of the CD-R/RW, recording device, or application software.

(Continued)

## Troubleshooting

Symptom	Cause and/or corrective action
"HOLD" flashes in the display when you press a button, and the CD does not play.	→ The buttons are locked. Slide the HOLD switch back. (page 23)
Playback starts from the point you stopped. (resume function)	→ The resume function is working. To start play from the first track, press and hold ►  /ENTER during stop until the first track starts playing, or open the lid of the CD player. Or remove all power sources, then insert the batteries or connect the AC power adaptor again. (pages 13, 14, 30)
Rustling noise is heard from the CD.	→ Close the lid of the battery compartment firmly. (page 30)
During playback of an ATRAC CD or MP3 CD, the CD does not rotate but you can hear the sound normally.	→ The CD player is designed to stop the rotation of an ATRAC CD or MP3 CD during playback to reduce the power consumption. The player is not malfunctioning.
"NO FILE" appears on the display after you press ►  /ENTER or when the lid of the CD player is closed.	→ There are no ATRAC3plus/ATRAC3/MP3 files in the CD. → A CD-R/RW from which the data has been erased is being used. → The CD is dirty.
When closing the lid of the CD player, the CD starts to rotate.	→ The CD player is reading the information on the CD. The player is not malfunctioning.
The LCD display becomes hard to see or slows down.	→ You are using your CD player at high temperatures (above 40°C/104°F) or at low temperatures (below 0°C/32°F). At room temperature, the display will return to its normal operating condition.
Play is stopped abruptly.	→ OFF TIMER has been set. Change the setting to "OFF"
The OFF TIMER function is canceled.	→ The OFF TIMER function for the CD is canceled if you start listening to the radio. The OFF TIMER function for the radio is canceled if you start playing a CD.

## Radio

Symptom	Cause and/or corrective actions
The audio is weak or has poor quality.	→ Replace the battery with a new LR6 (size AA) alkaline battery. (page 30) → Move the CD player away from electronic appliances (TVs, PCs, etc). → Keep the AC power adaptor away from the CD player.

# Specifications

## CD player

### System

Compact disc digital audio system

### Laser diode properties

Material: GaAlAs

Wavelength:  $\lambda = 770 - 800$  nm

Emission duration: Continuous

Laser output: Less than 44.6  $\mu$ W

(This output is the value measured at a distance of 200 mm from the objective lens surface on the optical pick-up block with 7 mm aperture.)

### D-A conversion

1-bit quartz time-axis control

### Frequency response

20 - 20 000 Hz  $_{-2}^{+1}$  dB (measured by JEITA)

### Output (at 4.5 V input level)

Headphones (stereo minijack)

Approx. 5 mW + Approx. 5 mW at 16  $\Omega$

(Approx. 1.5 mW + Approx. 1.5 mW at 16  $\Omega$ )\*

\*For the customers in Europe

## Radio

### Frequency range

#### ● CED, CEK, EE1\* models

FM: 87.5 - 108.0 MHz

AM: 531 - 1 602 kHz

#### ● E13/2, E92\* models

•9 kHz step:

FM: 87.5 - 108.0 MHz

AM: 531 - 1 710 kHz

•10 kHz step:

FM: 87.5 - 108.0 MHz

AM: 530 - 1 710 kHz

#### ● AU2, E13\* models

•9 kHz step:

FM: 87.5 - 108.0 MHz

AM: 531 - 1 602 kHz

•10 kHz step:

FM: 87.5 - 108.0 MHz

AM: 530 - 1 710 kHz

#### ● U, CA\* models

•9 kHz step:

TV: 2 - 13 ch

WB (weather band): 1 - 7 ch

FM: 87.5 - 108.0 MHz

AM: 531 - 1 710 kHz

•10 kHz step:

TV: 2 - 13 ch

WB (weather band): 1 - 7 ch

FM: 87.5 - 108.0 MHz

AM: 530 - 1 710 kHz

\* For the area code of the model you purchased, check the upper left side of the bar code on the package.

### Antenna

FM: Headphones/earphones cord antenna

AM: Built-in ferrite bar antenna

## General

### Power requirements

- Two LR6 (size AA) batteries: 1.5 V DC  $\times$  2
- AC power adaptor (DC IN 4.5 V jack):  
220 V, 50 Hz (Model for China)  
120 V, 60 Hz (Model for Mexico)

### Battery life\*1 (approx. hours)

When you use the CD player on a flat and stable surface.

When SOUND mode is set to "OFF:"

Playing time varies depending on how the CD player is used.

When using two Sony alkaline batteries LR6 (SG) (produced in Japan)

	G-PROTECTION	
	"G-PRO 1"	"G-PRO 2"
Audio CD	50	45
ATRAC CD*2	80	80
MP3 CD*3	62	62
RADIO ON	75	

\*1 Measured value by the standard of JEITA (Japan Electronics and Information Technology Industries Association)

\*2 Recorded at 48 kbps

\*3 Recorded at 128 kbps

(Continued)

---

## Specifications

### Operating temperature

5°C - 35°C (41°F - 95°F)

### Dimensions (w/h/d) (excluding projecting parts and controls)

Approx. 135.8 × 30.7 × 135.8 mm  
(5 3/8 × 1 1/4 × 5 3/8 in.)

### Mass (excluding accessories)

Approx. 195 g (6.9 oz.)

US and foreign patents licensed from Dolby Laboratories.

Design and specifications are subject to change without notice.

---

## Optional accessories

AC power adaptor* <sup>1</sup>	AC-E45HG
Active speaker system	SRS-Z1 SRS-Z30
Car battery cord* <sup>2</sup>	DCC-E345
Car battery cord with car connecting pack* <sup>2</sup>	DCC-E34CP
Car connecting pack* <sup>2</sup>	CPA-9C
Connecting cord	RK-G129 RK-G136
Earphones (except for the customers in France)	MDR-E818LP MDR-J10
Earphones (for the customers in France)	MDR-E808LP

\*<sup>1</sup> Specifications for AC power adaptors vary for each area. Check your the voltage and the shape of the plug in your area before purchasing an adaptor.

\*<sup>2</sup> When listening to the radio using these accessories, noise may occur. We recommend only playing CDs when you use them.

Your dealer may not handle some of the accessories listed above. Please ask the dealer for detailed information about the accessories in your country/region.



This warranty is valid only in the United States.

**SONY**<sup>®</sup>

Portable Memory Stick Audio Player/  
Portable MiniDisc Recorder/  
Portable CD Player

Portable Audio

## LIMITED WARRANTY

Sony Electronics Inc. ("Sony") warrants this Product (including any accessories) against defects in material or workmanship as follows:

1. **LABOR:** For a period of 90 days from the date of purchase, if this Product is determined to be defective, Sony will repair or replace the Product, at its option, at no charge, or pay the labor charges to any Sony authorized service facility. After the Warranty Period, you must pay for all labor charges.

2. **PARTS:** In addition, Sony will supply, at no charge, new or rebuilt replacements in exchange for defective parts for a period of one (1) year. After 90 days from the date of purchase, labor for removal and installation is available from Sony authorized service facilities or a Sony Service Center at your expense.

To obtain warranty service, you must take the Product, or deliver the Product freight prepaid, in either its original packaging or packaging affording an equal degree of protection, to any authorized Sony service facility.

This warranty does not cover customer instruction, installation, set up adjustments or signal reception problems.

This warranty does not cover cosmetic damage or damage due to acts of God, accident, misuse, abuse, negligence, commercial use, or modification of, or to any part of the Product, including the antenna. This warranty does not cover damage due to improper operation or maintenance, connection to improper voltage supply, or attempted repair by anyone other than a facility authorized by Sony to service the Product. This warranty does not cover Products sold AS IS or WITH ALL FAULTS, or consumables (such as fuses or batteries). This warranty is valid only in the United States.

Proof of purchase in the form of a bill of sale or receipted invoice which is evidence that the unit is within the Warranty period must be presented to obtain warranty service.

This warranty is invalid if the factory applied serial number has been altered or removed from the Product.

REPAIR OR REPLACEMENT AS PROVIDED UNDER THIS WARRANTY IS THE EXCLUSIVE REMEDY OF THE CONSUMER. SONY SHALL NOT BE LIABLE FOR ANY INCIDENTAL OR CONSEQUENTIAL DAMAGES FOR BREACH OF ANY EXPRESS OR IMPLIED WARRANTY ON THIS PRODUCT. EXCEPT TO THE EXTENT PROHIBITED BY APPLICABLE LAW, ANY IMPLIED WARRANTY OF MERCHANTABILITY OR FITNESS FOR A PARTICULAR PURPOSE ON THIS PRODUCT IS LIMITED IN DURATION TO THE DURATION OF THIS WARRANTY.

Some states do not allow the exclusion or limitation of incidental or consequential damages, or allow limitations on how long an implied warranty lasts, so the above limitations or exclusions may not apply to you. In addition, if you enter into a service contract with the Sony Partnership within 90 days of the date of sale, the limitation on how long an implied warranty lasts does not apply to you. This warranty gives you specific legal rights, and you may have other rights which vary from state to state.

For your convenience, Sony Electronics Inc. has established telephone numbers for frequently asked questions:

To locate the servicer or dealer nearest you, or for service assistance or resolution of a service problem, or for product information or operation, contact:

[www.sony.com/walkmansupport](http://www.sony.com/walkmansupport)

**Sony Network Portable Audio Support Line**  
1-866-456-7669

For an accessory or part not available from your authorized dealer, call:

1-800-488-SONY (7669)

D 324343303

<http://www.sony.net/>

Sony Corporation Printed in Malaysia



\* 3 2 6 6 3 6 6 1 2 \*

(1)