

This warranty is valid only in the United States.

**SONY**

Portable Memory Stick Audio Player/  
Portable MiniDisc Recorder/  
Portable CD Player/  
Portable IC Audio Player/  
Portable Hard Disk Audio Player

Portable Audio

## LIMITED WARRANTY

Sony Electronics Inc. ("Sony") warrants this Product (including any accessories) against defects in material or workmanship as follows:

1. **LABOR:** For a period of 90 days from the date of purchase, if this Product is determined to be defective, Sony will repair or replace the Product, at its option, at no charge, or pay the labor charges to any Sony authorized service facility. After the Warranty Period, you must pay for all labor charges.

2. **PARTS:** In addition, Sony will supply, at no charge, new or rebuilt replacements in exchange for defective parts for a period of one (1) year. After 90 days from the date of purchase, labor for removal and installation is available from Sony authorized service facilities or a Sony Service Center at your expense.

To obtain warranty service, you must take the Product, or deliver the Product freight prepaid, in either its original packaging or packaging affording an equal degree of protection, to any authorized Sony service facility.

This warranty does not cover customer instruction, installation, set up adjustments or signal reception problems.

This warranty does not cover cosmetic damage or damage due to acts of God, accident, misuse, abuse, negligence, commercial use, or modification of, or to any part of the Product, including the antenna. This warranty does not cover damage due to improper operation or maintenance, connection to improper voltage supply, or attempted repair by anyone other than a facility authorized by Sony to service the Product. This warranty does not cover Products sold AS IS or WITH ALL FAULTS, or consumables (such as fuses or batteries). This warranty is valid only in the United States.

Proof of purchase in the form of a bill of sale or receipted invoice which is evidence that the unit is within the Warranty period must be presented to obtain warranty service.

This warranty is invalid if the factory applied serial number has been altered or removed from the Product.

REPAIR OR REPLACEMENT AS PROVIDED UNDER THIS WARRANTY IS THE EXCLUSIVE REMEDY OF THE CONSUMER. SONY SHALL NOT BE LIABLE FOR ANY INCIDENTAL OR CONSEQUENTIAL DAMAGES FOR BREACH OF ANY EXPRESS OR IMPLIED WARRANTY ON THIS PRODUCT, EXCEPT TO THE EXTENT PROHIBITED BY APPLICABLE LAW. ANY IMPLIED WARRANTY OF MERCHANTABILITY OR FITNESS FOR A PARTICULAR PURPOSE ON THIS PRODUCT IS LIMITED IN DURATION TO THE DURATION OF THIS WARRANTY.

Some states do not allow the exclusion or limitation of incidental or consequential damages, or allow limitations on how long an implied warranty lasts, so the above limitations or exclusions may not apply to you. In addition, if you enter into a service contract with the Sony Partnership within 90 days of the date of sale, the limitation on how long an implied warranty lasts does not apply to you. This warranty gives you specific legal rights, and you may have other rights which vary from state to state.

For your convenience, Sony Electronics Inc. has established telephone numbers for frequently asked questions:

To locate the servicer or dealer nearest you, or for service assistance or resolution of a service problem, or for product information or operation, contact:

[www.sony.com/walkmansupport](http://www.sony.com/walkmansupport)

**Sony Network Portable Audio Support Line**  
1-866-456-7669

For an accessory or part not available from your authorized dealer, call:

1-800-488-SONY (7669)

D 324343304

**SONY**

Atrac CD Walkman  
**Portable  
CD Player** 

COMPACT  
disc  
DIGITAL AUDIO  
TEXT

**Atrac3plus**

**Atrac  
CD**

<http://www.sony.net/>

Sony Corporation Printed in China

© 2004 Sony Corporation

D-NE319/NE320/NE321

Operating Instructions

  
**WALKMAN**

## WARNING

**To prevent fire or shock hazard, do not expose the unit to rain or moisture.**

Do not install the appliance in a confined space, such as a bookcase or built-in cabinet.

To prevent fire, do not cover the ventilation of the apparatus with newspapers, tablecloths, curtains, etc. And don't place lighted candles on the apparatus.

To prevent fire or shock hazard, do not place objects filled with liquids, such as vases, on the apparatus.

### CAUTION

The use of optical instruments with this product will increase eye hazard.

Certain countries may regulate disposal of the battery used to power this product. Please consult with your local authority.

### CAUTION

- INVISIBLE LASER RADIATION WHEN OPEN
- DO NOT STARE INTO BEAM OR VIEW DIRECTLY WITH OPTICAL INSTRUMENTS
- CLASS 1M INVISIBLE LASER RADIATION WHEN OPEN
- DO NOT VIEW DIRECTLY WITH OPTICAL INSTRUMENTS

The validity of the CE marking is restricted to only those countries where it is legally enforced, mainly in the countries EEA (European Economic Area).

### Owner's Record

The model number and the serial number are located at the rear of the CD player. Record these numbers in the spaces provided below. Refer to them whenever you call upon your Sony dealer regarding this product.

Model No. \_\_\_\_\_  
Serial No. \_\_\_\_\_

**For customers who purchased this product in the USA**

### Product registration

Please register this product on line at [www.sony.com/walkmanreg](http://www.sony.com/walkmanreg)  
<<http://www.sony.com/walkmanreg>>

Proper registration will enable us to send you periodic mailings about software upgrades, new products, services and other important announcements. Thank you.

**If you have any questions about this product, contact:**  
**[www.sony.com/walkmansupport](http://www.sony.com/walkmansupport)**

**Sony Network Portable Audio Support Line**  
**1-(866)-456-7669**

**Sony Customer Information Services Center**  
**12451 Gateway Blvd., Ft. Myers, FL 33913**

This equipment has been tested and found to comply with the limits for a Class B digital device, pursuant to Part 15 of the FCC Rules. These limits are designed to provide reasonable protection against harmful interference in a residential installation. This equipment generates, uses, and can radiate radio frequency energy and, if not installed and used in accordance with the instructions, may cause harmful interference to radio communications. However, there is no guarantee that interference will not occur in a particular installation. If this equipment does cause harmful interference to radio or television reception, which can be determined by turning the equipment off and on, the user is encouraged to try to correct the interference by one or more of the following measures:

- Reorient or relocate the receiving antenna.
- Increase the separation between the equipment and receiver.
- Connect the equipment into an outlet on a circuit different from that to which the receiver is connected.
- Consult the dealer or an experienced radio/TV technician for help.

You are cautioned that any changes or modifications not expressly approved in this manual could void your authority to operate this equipment.

# Table of Contents

<b>Create Your Own ATRAC CDs.....</b>	<b>4</b>
Which discs can you play on this CD player? .....	5
<b>Precautions .....</b>	<b>7</b>
On safety .....	7
On the CD player .....	7
On handling CDs .....	7
On headphones/earphones.....	7

## Getting Started

<b>Checking the Supplied Accessories.....</b>	<b>8</b>
<b>Guide to Parts and Controls.....</b>	<b>9</b>
<b>Preparing a Power Source (Dry Battery) .....</b>	<b>10</b>
When using a rechargeable battery (for D- NE321 HK4, E18/1 models only*).....	11
Checking the remaining power of the battery.....	12
When using the AC power adaptor.....	13

## Playback

<b>Playing a CD .....</b>	<b>14</b>
Basic playback operations (Play, stop, search) .....	15
Locking the controls (HOLD) .....	16
<b>Searching for Your Favorite Track/File</b>	<b>16</b>
Searching by viewing groups (File View) 16	
Searching by viewing a list of groups/files (List View).....	17
Checking CD information on the display.17	
<b>Changing Playback Options (PLAY MODE) .....</b>	<b>19</b>
Playback options (PLAY MODE) .....	20
Playing groups.....	21
Playing your favorite tracks (Bookmark play).....	21

Playing your favorite play lists (m3u play list play).....	21
Playing tracks in your favorite order (PGM play).....	22
Playing tracks repeatedly (Repeat play) ...	22
<b>Changing Sound Quality .....</b>	<b>23</b>
Selecting the sound quality .....	23
Customizing sound quality .....	23
SOUND items .....	24
<b>Changing Optional Settings.....</b>	<b>25</b>
Setting various functions .....	25
OPTION items .....	26

## Additional Information

<b>Troubleshooting .....</b>	<b>28</b>
<b>Maintenance .....</b>	<b>31</b>
<b>Specifications.....</b>	<b>31</b>
<b>Optional Accessories .....</b>	<b>32</b>
<b>Index .....</b>	<b>33</b>

This manual describes how to use the CD player. For the supplied software SonicStage, please see "Installation/Operating Guide."

### Notice for users

#### On the supplied software

Depending on the type of the text and characters, the text shown on SonicStage may not be displayed properly on the device. This is due to:

- The limitations of the connected player.
- The player is not functioning normally.

ATRAC3plus is a trademark of Sony Corporation.

"WALKMAN" is a registered trademark of Sony Corporation to represent Headphone Stereo products.  is a trademark of Sony Corporation.

## Create Your Own ATRAC CDs

In addition to the usual audio CDs, you can play an original CD, called "ATRAC CD," that you create with the supplied software, SonicStage. Using SonicStage, about 30 audio CDs\* can be recorded on one CD-R or CD-RW.

The following is a quick overview of how you listen to music on your ATRAC CD.

### Install SonicStage on your computer.

SonicStage is software that takes music downloaded from audio CDs on your computer and creates original CDs. It can be installed from the supplied CD-ROM.



### Create an ATRAC CD.

After selecting your favorite songs from music stored on your computer, record them on a CD-R/CD-RW using SonicStage.

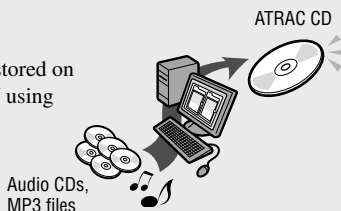

### Listen to them with this CD player.

You can take lots of songs wherever you go on your original CD.



Please see the supplied "Installation/Operating Guide" for how to install SonicStage and how to create ATRAC CDs.

\* When the total playing time of one CD (album) is estimated at 60 minutes and you are recording on a 700 MB CD-R/CD-RW at 48 kbps in ATRAC3plus format.

## Which discs can you play on this CD player?



### Audio CDs:

#### CD-DA format CDs

CD-DA (Compact Disc Digital Audio) is a recording standard used for Audio CDs.



### ATRAC CDs:

#### CD-R/CD-RW on which audio data compressed in the ATRAC3plus format has been recorded by using SonicStage\*

ATRAC3plus (Adaptive Transform Acoustic Coding3plus) is audio compression technology that satisfies the demand for high sound quality and high compression rates. ATRAC3plus can compress audio files to about 1/20 of their original size at 64 kbps.

Bit rates and sampling frequencies this CD player can play are:

	Bit rates	Sampling frequencies
ATRAC3	66/105/132 kbps	44.1 kHz
ATRAC3plus	48/64/256 kbps	44.1 kHz

Up to 62 characters can be displayed on this CD player.



### MP3 CDs:

#### CD-R/CD-RW on which audio data compressed in the MP3 format has been recorded by using a software other than SonicStage\*

Bit rates and sampling frequencies this CD player can play are shown below. Variable Bit Rate (VBR) files can also be played.

	Bit rates	Sampling frequencies
MPEG-1 Layer3	32 - 320 kbps	32/44.1/48 kHz
MPEG-2 Layer3	8 - 160 kbps	16/22.05/23 kHz
MPEG-2.5 Layer3	8 - 160 kbps	8/11.025/12 kHz

This CD player conforms to Version 1.0/1.1/2.2/3.2/4 of the ID3 tag format. ID3 tag is a format for adding certain information (track name, album name, artist name, etc.) to MP3 files. Up to 64 characters of ID3 tag information can be displayed on this CD player.



### CD-Extra and Mix-Mode CDs:

#### CD-R/CD-RW on which CD-DA format data and CD-ROM format data are recorded together.\*

If you cannot play your CD, change the “CD-EXTRA” setting in the OPTION menu (Ⓞ page 27). Then you may play your CD.

An ATRAC CD on which audio data compressed in the MP3 format has been recorded using software other than SonicStage can also be played.

With SonicStage, you cannot create a CD on which mixed format audio data is recorded.

\* Only ISO 9660 Level 1/2 and Joliet extension format discs can be played.

## Music discs encoded with copyright protection technologies

This product is designed to play back discs that conform to the Compact Disc (CD) standard. Recently, various music discs encoded with copyright protection technologies are marketed by some record companies. Please be aware that among those discs, there are some that do not conform to the CD standard and may not be playable by this product.

## Difference in file structures of ATRAC CDs and MP3 CDs

ATRAC CDs and MP3 CDs consist of "files" and "groups." A "file" is equivalent to a "track" of an audio CD. A "group" is a bundle of files and is equivalent to an "album."

For MP3 CDs, this CD player recognizes an MP3 folder as a "group" so that ATRAC CDs and MP3 CDs can be operated in the same way.

### The usable number of groups and files

- Maximum number of groups: 256
- Maximum number of files: 999

### Playing order of ATRAC CDs and MP3 CDs

For ATRAC CDs, files are played in the order selected in SonicStage.

For MP3 CDs, the playing order may differ depending on the method used to record MP3 files on the disc. A "play list" which contains an MP3 file playing order can also be played. In the following example, files are played in order of ① to ⑦.

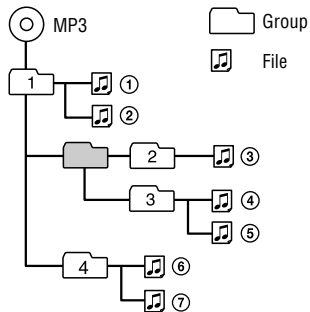

(Maximum directory levels: 8)

### Notes

- If ATRAC3plus files and MP3 files are recorded on the same CD, this CD player plays the ATRAC3plus files first.
- The playback capability of this CD player may vary depending on the quality of the disc and the condition of the recording device.
- Acceptable characters are A to Z, a to z, 0 to 9, and \_ (underscore).
- On a disc that has ATRAC3plus/MP3 files, do not save files in other formats and do not make unnecessary folders.

### About ATRAC CDs

- CD-Rs/CD-RWs recorded in the ATRAC3plus format cannot be played on your computer.

### About MP3 CDs

- Be sure to add the file extension "mp3" to the file name. However, if you add the extension "mp3" to a file other than an MP3 file, the player will not be able to recognize the file properly.
- To compress a source in an MP3 file, we recommend setting the compression parameters to "44.1 kHz," "128 kbps," and "Constant Bit Rate."
- To record up to the maximum capacity, set the writing software to "halting of writing."
- To record up to the maximum capacity at one time on media that has nothing recorded on it, set the writing software to "Disc on Once."

---

## Precautions

### On safety

- Should any solid objects or liquid fall into the CD player, unplug it and have it checked by qualified personnel before operating it any further.
- Do not put any foreign objects in the DC IN 3 V (external power input) jack.

### On the CD player

- Keep the lens on the CD player clean and do not touch it. If you do so, the lens may be damaged and the CD player will not operate properly.
- Do not put any heavy object on top of the CD player. The CD player and the CD may be damaged.
- Do not leave the CD player in a location near heat sources, or in a place subject to direct sunlight, excessive dust or sand, moisture, rain, mechanical shock, unlevelled surface, or in a car with its windows closed.
- If the CD player causes interference to the radio or television reception, turn off the CD player or move it away from the radio or television.
- Discs with non-standard shapes (e.g., heart, square, star) cannot be played on this CD player. Attempting to do so may damage the CD player. Do not use such discs.

### On handling CDs

- To keep the CD clean, handle it by its edge. Do not touch the surface.
- Do not stick paper or tape onto the CD.
- Do not expose the CD to direct sunlight or heat sources such as hot air ducts. Do not leave the CD in a car parked under direct sunlight.

## On headphones/earphones

### Road safety

Do not use headphones/earphones while driving, cycling, or operating any motorized vehicle. It may create a traffic hazard and is illegal in some areas. It can also be potentially dangerous to play your headsets at high volume while walking, especially at pedestrian crossings. You should exercise extreme caution or discontinue use in potentially hazardous situations.

### Preventing hearing damage

Avoid using headphones/earphones at high volume. Hearing experts advise against continuous, loud and extended play. If you experience a ringing in your ears, reduce volume or discontinue use.

### Consideration for others

Keep the volume at a moderate level. This will allow you to hear outside sounds and to be considerate to the people around you.

## Checking the Supplied Accessories

- AC power adaptor (AC-ES3010K2) (not supplied with USA/Canadian models)
- Headphones (for D-NE321 AR2, E92, E18/4, MX2 models only\*)

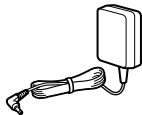

- Earphones (for D-NE320 European models and D-NE321 HK4, E18/1 models only\*)



- Earphones (for other models)



- Remote (for D-NE320 European models and D-NE321 HK4, E18/1 models only\*)

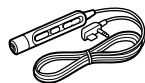

- Remote (for D-NE320 USA/Canadian models and D-NE321 E92, E18/4, MX2 models only\*)



- Rechargeable battery (for D-NE321 HK4, E18/1 models only\*)
- Battery carrying case (for D-NE321 HK4, E18/1 models only\*)



- CD-ROM (SonicStage)

Do not play this CD-ROM on an audio CD player including this player.



- Operating instructions (This book)
- Installation/Operating Guide

\* For the area code of the model you purchased, check the upper left side of the bar code on the package.

### Note

Use only the supplied remote. You cannot operate this player with any other remote.

### Connect the plug of your earphones/headphones to the remote securely.

- For D-NE320 European models and D-NE321 HK4, E18/1 models only

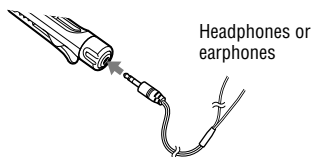

- For D-NE320 USA/Canadian models and D-NE321 E92, E18/4, MX2 models only

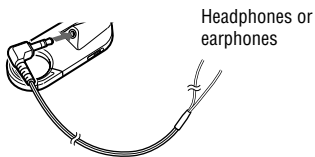

### Wearing the supplied headphones (for D-NE321 AR2, E92, E18/4, MX2 models only\*)

The following procedures are for wearing on the left ear.

- 1 Hook the **L** part over your left ear and the **R** part over your right ear as illustrated.

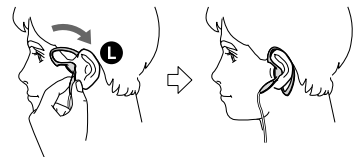

- 2 Hook the headphones around your ears, as you would with glasses.
- 3 Adjust the earpieces to comfortably fit your ears.

### Note on handling the supplied headphones

Do not put weight or pressure on the headphones as it may cause the headphones to deform during long storage.



# Guide to Parts and Controls

## CD player

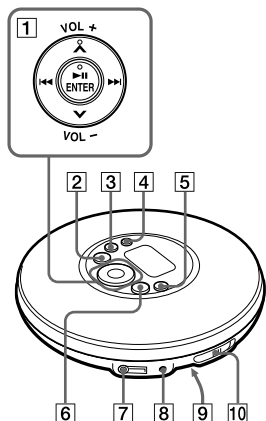

### Remote (for D-NE320 USA/Canadian models and D-NE321 E92, E18/4, MX2 models only)

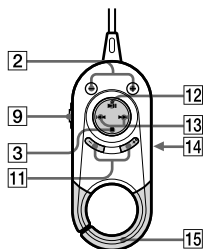

### Remote (for D-NE320 European models and D-NE321 HK4, E18/1 models only)

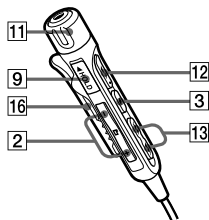

- 1 Operation button
  - ▶|| (play/pause)<sup>1)</sup>/ENTER (☞ page 14-17, 21-23, 25)
  - ◀◀/▶▶ (☞ page 15, 17, 21, 23)
  - Λ<sup>1)</sup>/V (☞ page 16, 17, 19, 21-23, 25)
  - VOL +/- (☞ page 14)
- 2 CD player:
  - ☞ button (☞ page 15-17, 22)
  - Remote:
    - ☞ +/- buttons (☞ page 15)
- 3 CD player:
  - D-NE321 HK4, E18/1 models<sup>2)</sup>:
    - (stop)/CHG button (☞ page 11, 15-17)
  - Other models:
    - (stop)button (☞ page 15-17)
    - Remote:
      - (stop)button (☞ page 15)
- 4 SEARCH button (☞ page 16, 17)
- 5 DISPLAY/MENU button (☞ page 18, 19, 21, 23)
- 6 ☞+ button (☞ page 15, 16, 22)
- 7 ◻ (headphones) jack (☞ page 14)
- 8 DC IN 3 V jack (☞ page 11, 13)
- 9 HOLD switch (on the back of the CD player) (☞ page 16)
- 10 OPEN switch (☞ page 10, 14)
- 11 D-NE320 USA/Canadian models and D-NE321 E92, E18/4, MX2 models: VOL +/- buttons (☞ page 14)
- D-NE320 European models and D-NE321 HK4, E18/1 models: VOL +/- control (☞ page 14)
- 12 ▶||(play/pause)<sup>1)</sup> button (☞ page 14, 15)
- 13 ◀◀/▶▶ buttons (☞ page 15)
- 14 Headphones jack (on the back)
- 15 Hook
- 16 Clip

Continued ➞

## Display

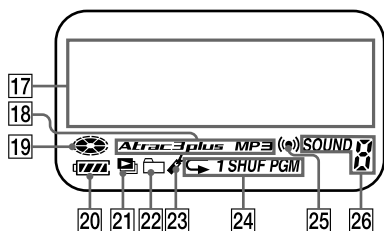

- 17 Character information display (☞ page 18)
- 18 Atrac3plus/MP3 indicator (☞ page 5)
- 19 Disc indicator (☞ page 14)
- 20 Battery indicator (☞ page 12)
- 21 Play list indicator
- 22 Group indicator
- 23 Bookmark indicator (☞ page 21)
- 24 Play mode indicator
- 25 Timer indicator (☞ page 26)
- 26 Sound indicator

- 1) This button has a tactile dot.
- 2) For the area code of the model you purchased, check the upper left side of the bar code on the package.

## Preparing a Power Source (Dry Battery)

Use only the following dry battery type for your CD player:

- LR6 (size AA) alkaline battery

- 1 Slide the **OPEN** switch to open the lid of your player.

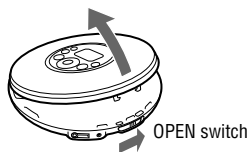

- 2 Open the battery compartment lid inside the player.

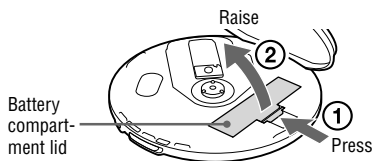

- 3 Insert the LR6 (Size AA) battery (not supplied) by matching the **+** to the diagram in the battery compartment and close the lid until it clicks into place.

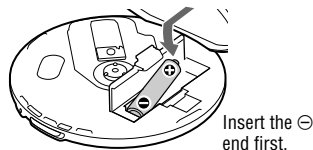

## To remove the battery

Remove the battery as illustrated below.

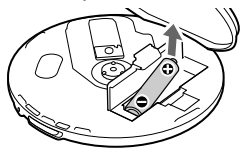

## When using a rechargeable battery (for D-NE321 HK4, E18/1 models only\*)

Charge the rechargeable battery before using it for the first time or when it is depleted.

To maintain the original battery capacity longer, charge the battery only when it is completely depleted (“Low Battery” appears on the display).

\* For the area code of the model you purchased, check the upper left side of the bar code on the package.

**1** Slide the OPEN switch to open the lid of your player.

**2** Open the battery compartment lid inside the player.

**3** Insert the NH-7WMAA rechargeable battery by matching the ⊕ to the diagram in the battery compartment and close the lid until it clicks into place.

**4** Connect the AC power adaptor to the DC IN 3 V jack of your CD player and an AC outlet, then press ■/CHG to start charging.

“Charging” indication flashes and the indicator sections of  light up in succession.

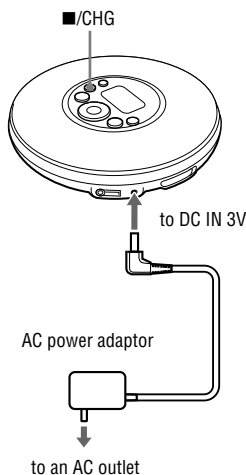

When the battery is completely charged, “Charging” disappears.

### Notes

- Do not charge any rechargeable battery other than an NH-7WMAA.
- During charging, the player and the rechargeable battery become hot. This poses no danger.
- Take out the rechargeable battery when the player is not to be used for a long time.

Continued 

## Note on the useful life of the rechargeable battery and when to replace it

If the battery is new or has not been used for a long time, it may not charge completely.

In that case, charge it until “Charging” disappears from the display and then use the player until the battery is completely depleted (“Low Battery” appears on the display).

Repeat this procedure several times.

If the battery life is shorter by about half of a normal charge after trying this procedure, replace the battery with a new rechargeable battery.

## Note on carrying the rechargeable battery

Use the supplied battery carrying case to protect against unexpected heat. If the rechargeable battery comes into contact with the metallic objects, heat or fire may occur due to a short circuit.

## Checking the remaining power of the battery

The remaining power of the battery is indicated in the display as shown below. As the black indicator section decreases, the remaining power is depleted further.

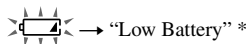
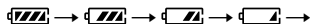

\* Beep sounds.

When the battery is depleted, replace it with a new one or charge the rechargeable battery\*.

\* D-NE321 HK4, E18/1 models only

### Notes

- The display shows the approximate battery power remaining. For example, one section does not always indicate one-fourth of the battery power.
- Depending on the operating conditions, the display may increase or decrease relative to the actual power remaining.

## Battery life <sup>1)</sup>

### When using one alkaline battery <sup>2)</sup>

	G-PROTECTION	
	“1”	“2”
Audio CD	22	20
ATRAC CD <sup>3)</sup>	41	38
MP3 CD <sup>4)</sup>	26	24

### When using one NH-7WMAA rechargeable battery (charged for about 5 hours <sup>5) 6)</sup>)

	G-PROTECTION	
	“1”	“2”
Audio CD	10	9
ATRAC CD <sup>3)</sup>	17	15
MP3 CD <sup>4)</sup>	12	11

- 1) Measured value using the JEITA (Japan Electronics and Information Technology Industries Association)  
Playing time shown is approximate hours, when you use the player on a flat and stable surface and “POWER SAVE” is set to “ON” (Ⓞ page 27).  
This value varies depending on how the player is used.
- 2) When using a Sony LR6 (SG) alkaline battery (produced in Japan)
- 3) Recorded at 48kbps
- 4) Recorded at 128kbps
- 5) Charging time varies depending on how the rechargeable battery is used.
- 6) D-NE321 HK4, E18/1 models only

## Notes on rechargeable batteries and dry batteries

- Do not charge dry batteries.
- Do not throw the batteries into a fire.
- Do not carry batteries in a pocket, etc. with coins or other metallic objects. The battery can generate heat if its positive and negative terminals are accidentally allowed to come into contact with a metallic object.
- When the batteries are not to be used for a long time, remove them.
- If battery leakage occurs, wipe off any deposit left in the battery compartment, and install new batteries. If the deposit adheres to your skin, wash it off thoroughly.

## When using the AC power adaptor

You can use the player powered by the AC power adaptor without the battery.

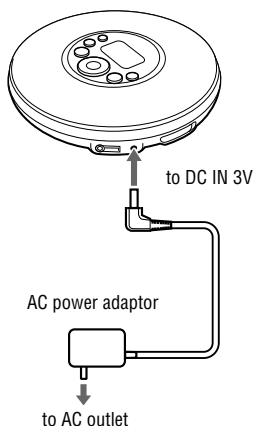

- 1 **Connect the AC power adaptor to the DC IN 3V jack of your CD player and an AC outlet.**

### Notes on the AC power adaptor

- Disconnect all power sources when the player is not to be used for a long time.
- Use only the AC power adaptor supplied. If your player is not supplied with the one, use an AC-E30HG AC power adaptor (not available in Australia and Argentina). If you use any other AC power adaptor, malfunction may occur.

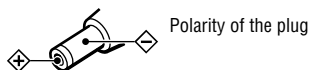

- Do not touch the AC power adaptor with wet hands.
- Connect the AC power adaptor to an easily accessible AC outlet. Should you notice an abnormality in the AC power adaptor, disconnect it from the AC outlet immediately.

## Playing a CD

### 1 Slide the OPEN switch to open the player lid.

Connect the headphones/earphones to the player beforehand.

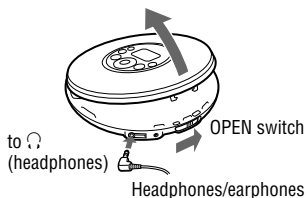

### 2 Place the CD on the tray and close the lid.

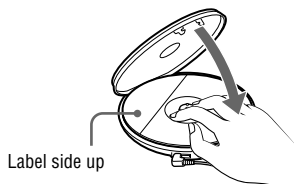

### 3 Press ►II/ENTER.

(disc) moves, and the player starts playback.

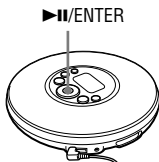

### 4 Adjust the volume by pressing VOL +/-.

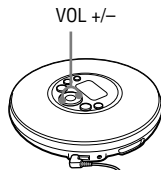

### On the remote: D-NE320 USA/Canadian models and D-NE321 E92, E18/4, MX2 models:

After placing the CD on the tray in step 2, press ►II and adjust the volume by pressing VOL +/-.

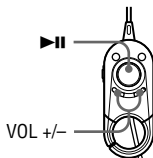

### D-NE320 European models and D-NE321 HK4, E18/1 models:

After placing the CD on the tray in step 2, press ►II and adjust the volume by turning VOL +/-.



### To remove the CD

Remove the CD while pressing the pivot in the center of the tray.



## Basic playback operations (Play, stop, search)

To	Operation
<b>Play</b> Play from the first track	From stop, press and hold ►►/ENTER (►► on the remote) until playback starts.
<b>Stop</b> Pause/Resume play after pausing	Press ►►/ENTER (►► on the remote).
Stop playback	Press ■ (stop) <sup>4)</sup> .
<b>Search</b> Find the beginning of the current track <sup>1)</sup>	Press ◀◀ once.
Find the beginning of previous tracks <sup>1)</sup>	Press ◀◀ repeatedly.
Find the beginning of the next track <sup>1)</sup>	Press ►► once.
Find the beginning of succeeding tracks <sup>1)</sup>	Press ►► repeatedly.
Go backwards quickly <sup>1) 3)</sup>	Press and hold ◀◀.
Go forward quickly <sup>1) 3)</sup>	Press and hold ►►.
Jump to succeeding groups <sup>2)</sup>	Press ◻ (group) + repeatedly.
Jump to previous groups <sup>2)</sup>	Press ◻ (group) – repeatedly.

1) You can operate during both play and pause.

2) You can operate during play of a CD other than audio CDs.

3) You cannot operate when using an MP3 file recorded on a CD-R/CD-RW in a packet write format.

4) ■/CHG for the D-NE321 HK4, E18/1 models.

Continued ⇨

## Locking the controls (HOLD)

You can prevent accidental button presses while carrying the player by locking the controls.

### 1 Slide the HOLD switch on the back of the player in the direction of the arrow.

“HOLD” flashes if you press any button when the HOLD function is activated.

For the models supplied with the remote: You can use the HOLD function for the remote and the player (on the back) separately. For example, even if the HOLD function on the player is activated, you can operate the player by using the remote unless you set HOLD on the remote to on, too.

### To unlock the controls

Slide the HOLD switch in the direction opposite to that of arrow.

## Searching for Your Favorite Track/File

### Searching by viewing groups (File View)

On a CD such as an ATRAC CD or an MP3 CD on which a number of files are recorded, you can search for a file by checking the names of groups (except on an audio CD) or files around the file being played.

#### 1 Press SEARCH repeatedly.

The names of groups and files around the current file appear on the display.

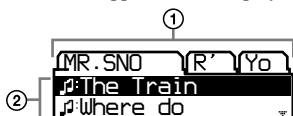

- ① Group names
- ② File names

#### 2 Press $\square +$ or $\square -$ to select a group.

#### 3 Press $\wedge$ or $\vee$ to select a file.

#### 4 Press $\blacktriangleright$ /ENTER.

The file you have selected starts playing.

### To cancel searching

Press  $\blacksquare$ .



## Searching by viewing a list of groups/files (List View)

You can search for a track/file by checking the format type of the music source and the names of groups and files.

### 1 Press SEARCH repeatedly.



If you play a CD on which mixed audio data has been recorded:

The screen for selecting the format type such as "ATRAC ROOT" and "MP3 ROOT" appears first.

Press ►II/ENTER.

### 2 Press ▲ or ▼ to select a group and press ►II/ENTER.

### 3 Press ▲ or ▼ to select a file.

### 4 Press ►II/ENTER.

The file you have selected starts playing.

### To return to the previous screen

Press ◀◀ or ◀-.

### To cancel searching

Press ■.

## Checking CD information on the display

You can check CD information on the display. Depending on the region in which you purchased your CD player, the default language may not be "ENGLISH." Change the LANGUAGE setting, if necessary (⌚ page 26).

When you are playing an MP3 CD containing files with an ID3 tag, ID3 tag information is displayed. (When there is no ID3 tag information, file name or group name is displayed.) (⌚ page 5)

### Notes

- The characters A-Z, a-z, 0-9, and \_ can be displayed on this player.
- Before playing a file, the player reads all file and group (or folder) information on the CD. "Reading" is displayed. Depending on the content of the CD, it may take some time to accomplish this reading.
- If the file does not belong to any group, "MP3 ROOT" appears on the display.

Continued ➞

## To check information on the display

Press DISPLAY/MENU repeatedly.

### Audio CD

Track number, elapsed playing time  
(Artist name, track name)<sup>1)</sup>



Total number of tracks on the CD, total remaining time of the CD, remaining time of the current track<sup>2)</sup>

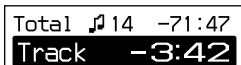

File view screen



### ATRAC CD/MP3 CD

File name, artist name<sup>3)</sup>, file number, elapsed playing time



Group name<sup>3)</sup>, CODEC information<sup>4)</sup>, total number of files



File view screen

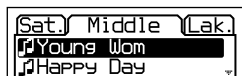



- 1)When you are playing an audio CD containing text information such as CD-TEXT, information in parentheses is displayed.
- 2)The displays appear only during normal play.
- 3)During play, “artist name” is not displayed if the disc does not have ID3 tag information. When the list of group names/file names appears on the display, “artist name” and “group name” are not displayed.
- 4)Bit rate and sampling frequencies are displayed. While an MP3 file made at VBR (variable bit rate) is being played, “VBR” appears on the display instead of a bit rate. In some cases, “VBR” appears halfway through playback, rather than from the beginning.

---

## Changing Playback Options (PLAY MODE)



You can use various playback options such as selecting songs you want to listen to, and playing songs in your favorite order.

For details about playback options, see  page 20.

You can also play songs repeatedly using the playback options you choose (repeat play,  page 22).

- 
- 1 Press **DISPLAY/MENU** until the menu screen appears.



 : PLAYMODE  
 : SOUND  
 : OPTION

- 
- 2 Press **^** or **v** to select “ **PLAY MODE**.”

- 
- 3 After pressing **▶II/ENTER**, press **^** or **v** to select the playback option.

The default setting is “ALL” (normal play).



- 
- 4 Press **▶II/ENTER**.

- 
- 5 When “REPEAT” appears, select “ON” or “OFF” and press **▶II/ENTER**.



### To return to normal play

Select “ALL” in the PLAY MODE menu.

Continued 

## Playback options (PLAY MODE)

Display on the CD player	Explanation
ALL	All tracks on the CD are played in a track number order. For the ATRAC CD/MP3 CD, a playing order is different according to the setting of the "PLAY ORDER" in the OPTION menu.
GROUP	All files in the selected group or all groups are played (ATRAC CD/MP3 CD only) (Ⓞ page 21).
1	The current track is played once.
SHUFFLE	All tracks on the CD are played once in random order.
GROUP SHUFFLE	All files in the selected group are played once in random order (ATRAC CD/MP3 CD only) (Ⓞ page 21).
BOOKMARK	Tracks to which Bookmarks have been added are played. The play of tracks with Bookmarks starts in track number order, not in the order you added the Bookmarks (Ⓞ page 21).
PLAYLIST	Tracks in the selected m3u play list* are played (MP3 CD only) (Ⓞ page 21).
AUTO RANKING	The tracks you have played most frequently from the CD are played from the 10th to the first.
RANKING SHUF	Up to 32 tracks, which the player has automatically memorized as the most frequently played ones, are played in random order.
PROGRAM	Up to 64 tracks are played in your favorite order (Ⓞ page 22).
INTRO	About the first 10 seconds of all tracks which follow the current track are played once.

\*An m3u play list is a file in which an MP3 file playing order has been encoded. To use the play list function, record MP3 files on a CD-R/CD-RW using encoding software that supports the m3u format.  
You can play the top 8 lists (listed by file name) on your screen on the CD player.

## Playing groups

**1** Perform steps 1 and 2 of “Changing Playback Options (PLAY MODE)” (page 19). In step 3, select “GROUP” or “GROUP SHUFFLE” and press ►II/ENTER.

**2** Press  $\wedge$  or  $\vee$  to select a group.

If you select a group on an MP3 CD, etc. by searching through all the directories, press ◀◀ or ▶▶.

If you select a group within the same directory, press  $\wedge$  or  $\vee$ .

**3** Press ►II/ENTER for 2 seconds or more.

The player starts playback of all files in the group you have selected.

**4** When “REPEAT” appears, select “ON” or “OFF” and press ►II/ENTER.

### Note

If the group has no tracks, “Invalid” appears on the display.

## Playing your favorite tracks (Bookmark play)

**1** During play of the track to which you want to add a Bookmark, press ►II/ENTER until  flashes slowly.

**2** If you want to add a Bookmark to two or more tracks, repeat step 1.

You can add Bookmarks to up to 10 CDs for audio CDs (up to 99 tracks for each CD) and up to 5 CDs for ATRAC CDs/MP3 CDs (up to 999 tracks for each CD).

**3** Press DISPLAY/MENU until the menu screen appears.

**4** Press  $\wedge$  or  $\vee$  to select “PLAY MODE,” and press ►II/ENTER.

**5** Press  $\wedge$  or  $\vee$  to select “BOOKMARK,” and then press ►II/ENTER.

**6** When “REPEAT” appears, select “ON” or “OFF” and press ►II/ENTER.

### To remove Bookmarks

During play of a track with a Bookmark, press and hold ►II/ENTER until  disappears.

### Notes

- If you try to add Bookmarks to tracks on an 11th CD (on a 6th CD when playing ATRAC CDs/MP3 CDs), the Bookmarks of the CD you played first will be erased.
- All Bookmarks stored in memory will be erased if you remove all power sources.
- For D-NE321 HK4, E18/1 models only: All Bookmarks stored in memory will also be erased if you continue playing the player on the rechargeable battery while “Low Battery” is displayed, without charging the battery.

## Playing your favorite play lists (m3u play list play)

**1** In step 3 of “Changing Playback Options (PLAY MODE)” (page 19), select “PLAYLIST.”

**2** Press  $\wedge$  or  $\vee$  to select a play list.

**3** Press ►II/ENTER.

Continued 

## Playing tracks in your favorite order (PGM play)

---

- 1 While the player is stopped, select “PROGRAM” in step 3 of “Changing Playback Options (PLAY MODE)” (☞ page 19), and then press ►II/ENTER.



- 2 Press  $\wedge$  or  $\vee$  to select a track, and press and hold ►II/ENTER until display changes.

When playing an ATRAC CD/MP3 CD:  
You can also select a file in another group by pressing  $\square+$  or  $\square-$ .

- 3 Repeat step 2 to select tracks in your favorite order.

You can select up to 64 tracks.  
When you finish entering the 64th track, the track number selected first (audio CD)/file name (ATRAC CD/MP3 CD) appears on the display.  
If you select 65 tracks or more, the tracks selected first are erased one by one.

- 4 Press ►II/ENTER.

Playback starts in the selected order.

### To check the program

- 1 While the player is stopped, select “PROGRAM” in step 3 of “Changing Playback Options (PLAY MODE)” (☞ page 19), and then press ►II/ENTER.
- 2 Press and hold ►II/ENTER until the display changes. Whenever you press ►II/ENTER, the tracks are displayed in playing order.

### To cancel the PGM play

Press ■.

## Playing tracks repeatedly (Repeat play)

---

- 1 Select “ON” in step 5 of “Changing Playback Options (PLAY MODE)” (☞ page 19).

### To return to normal play

Select “OFF”.

## Changing Sound Quality

For details about the setting of SOUND items, see  page 24.

### Selecting the sound quality

You can set up the “EQUALIZER” setting and/or “CLEARBASS” setting. If you set both at the same time, you can enjoy more bass sound along with the sound quality you want.

- 1 Press **DISPLAY/MENU** until the menu screen appears.

- 2 Press **^** or **v** to select “ SOUND.”



- 3 After pressing **▶II/ENTER**, press **^** or **v** to select the item you want to set up and press **▶II/ENTER**.

- 4 Press **^** or **v** to select an option and press **▶II/ENTER**.

### Customizing sound quality

You can adjust sound quality for each frequency range individually, checking the shape of the wave on the display.

- 1 Select “EQUALIZER” in step 3 and “CUSTOM” in step 4 of “Selecting the sound quality”.

“Low” is displayed first.

There are 3 frequency ranges; “Low” (low range audio), “Mid” (middle range audio), and “High” (high range audio).



- 2 Press **◀◀** or **▶▶** for 2 seconds or more to select the frequency range.

- 3 Press **◀◀** or **▶▶** repeatedly to select the shape of the wave.

There are 3 shapes stored in memory for each frequency range.

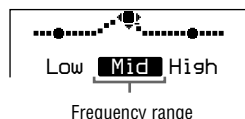

- 4 Press **^** or **v** to select the sound volume.

The sound volume can be adjusted in 7 levels.

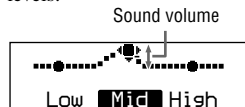

- 5 Repeat steps 2 to 4 to make adjustments for the remaining 2 frequency ranges.

- 6 Press **▶II/ENTER**.

To return to the previous screen

Press **■**.

To cancel the adjustment operation

Press **■** on the remote for 2 seconds or more.

#### Notes

- If the sound is distorted by your sound settings when you turn up the volume, turn the volume down.
- If you feel a difference in sound volume between the “CUSTOM” sound setting and other sound settings, adjust the volume to your preference.

Continued 

## SOUND items

To return to the previous screen, press **■**. To cancel the setting operation, press **■** for 2 seconds or more.

Item	Options (●: Default setting)	
EQUALIZER (Equalizer setting)	● OFF	Normal sound quality
	SOFT	For vocal, stressing middle range audio
	ACTIVE	Lively sounds, emphasizing high and low range audio
	HEAVY	Powerful sounds, further emphasizing high and low ranges compared with ACTIVE sound
	CUSTOM	Customized sound (see  page 23 for details)
CLEARBASS (Bass sound setting)	● OFF	Normal sound quality.
	1	Emphasizing bass sound.
	2	Emphasizing bass sound more than 1.
	3	Emphasizing bass sound more than 2.

### Note

If you change the setting of the EQUALIZER item after you have set the CLEARBASS item, the setting of the EQUALIZER item gets priority.

When you set both the EQUALIZER item and the CLEARBASS item, set the EQUALIZER item first.



---

## Changing Optional Settings

For details about the setting of OPTION items, see [page 26](#).

### Setting various functions

You can set the various functions such as the language for the menu and the playback order of the groups/files.

- 
- 1 Press **DISPLAY/MENU** until the menu screen appears.

- 
- 2 Press **^** or **v** to select “**OPTION**.”



- 
- 3 After pressing **▶II/ENTER**, press **^** or **v** to select the item you want to set up and press **▶II/ENTER**.

- 
- 4 Press **^** or **v** to select an option and press **▶II/ENTER**.

When you are setting the “LANGUAGE” or “PLAY ORDER,” repeat step 3.

Continued 

## OPTION items

To return to the previous screen, press **■**. To cancel the setting operation, press **■** for 2 seconds or more.

Items	Options (●: Default settings)		
LANGUAGE (Language for menu, etc.)	MENU	<ul style="list-style-type: none"> <li>● ENGLISH</li> <li>FRENCH</li> <li>GERMAN</li> <li>ITALIAN</li> <li>PORTUGUESE</li> <li>RUSSIAN</li> <li>SPANISH</li> </ul>	Select the language for menu text, warning message, etc.
	TEXT <sup>1)</sup>	<ul style="list-style-type: none"> <li>● AUTO</li> <li>ENGLISH</li> <li>FRENCH</li> <li>GERMAN</li> <li>ITALIAN</li> <li>PORTUGUESE</li> <li>RUSSIAN</li> <li>SPANISH</li> </ul>	Select the language for CD-TEXT, ID3 tag, etc. If you select "AUTO," you can read the text in the following language.
G-PROTECTION <sup>1)</sup> (To prevent sound skipping)	● 1		Protection against sound skipping is provided with high quality CD sound.
	2		Enhanced protection against sound skipping is provided.
AVLS <sup>2)</sup> (Limiting volume)	● OFF		The volume changes without limiting the volume level.
	ON		The maximum volume is limited to protect your hearing.
TIMER (Off timer)	● OFF		The timer does not work.
	1-99 min		(●) is displayed on the player. You can check the remaining playback time by selecting this option during play. Press <b>▲</b> or <b>▼</b> repeatedly to increase or decrease the length of time by 5 minutes, or keep pressing <b>▲</b> or <b>▼</b> to increase or decrease by 1 minute. The default setting is "10 min."
BEEP (Sound of operation)	● ON		The beep sounds when you operate the player.
	OFF		The beep is turned off.
SEAMLESS <sup>1)3)</sup> (Playing tracks continuously)	● OFF		The CD is played as recorded on the disc, including spaces between tracks.
	ON		The CD is played without space between tracks.

Items	Options (●: Default settings)		
POWER SAVE (Saving power)	● OFF	The POWER SAVE function does not work.	
	ON	Setting of the SOUND items is not effective.	
PLAY ORDER <sup>1)</sup> (Playback order)	TRACK	● NORMAL	Play back the music source in the order of recording.
		ID3TAG TNO	Play back in the order of ID3 tag number.
		FILE NAME	Play back in the alphabetical order of the file names.
	GROUP	● OFF	Play back the music source in the order of recording.
		ON	Play back the music source in the order of group names.
CD-EXTRA <sup>1) 4)</sup> (Playback by disc format)	● OFF	Set to "OFF" as long as you can play your CD normally.	
	ON	If you cannot play your CD-Extra, set to "ON." You may play it.	

1) You can set this up only while the player is stopped.

2) AVLS is an abbreviation of the Automatic Volume Limiter System.

3) This function works only for ATRAC CDs.

4) This function works only for Audio CDs and CD-Extra CDs.

### Notes

- Even if "G-PROTECTION" is set to "2," sound may skip:
  - when the CD player receives stronger continuous shock than expected,
  - when a dirty or scratched CD is played, or
  - for CD-Rs/CD-RWs, when a poor-quality disc is played or there is a problem with the original recording device or application software.
- Even if "SEAMLESS" is set to "ON," the tracks may not play continuously depending on how the source music was recorded.

## Troubleshooting

Should any problem persist after you have checked these symptoms, consult your nearest Sony dealer.

### Power <sup>1)</sup>

Symptom	Cause and/or corrective action
The rechargeable battery cannot be charged.	<ul style="list-style-type: none"> <li>→ The rechargeable battery is not inserted in the battery compartment. Insert the rechargeable battery (☞ page 11).</li> <li>→ You pressed ■ on the remote. During stop, press ■/CHG on the CD player. <sup>2)</sup></li> </ul>

### Sound





Symptom	Cause and/or corrective action
The volume does not increase even if you press VOL + repeatedly.	→ "AVLS" is set to "ON." Set it to "OFF" (☞ page 26).
No sound, or noise is heard.	<ul style="list-style-type: none"> <li>→ Connect the headphones/earphones plugs firmly.</li> <li>→ The plugs are dirty. Clean the headphones/earphones plugs with a dry soft cloth periodically.</li> </ul>
A rustling noise is heard from the CD.	→ Close the lid of the battery compartment firmly (☞ page 10).

### Operation/Playback

Symptom	Cause and/or corrective action
The playing time is too short. The CD does not play.	<ul style="list-style-type: none"> <li>→ Check that you are using an alkaline battery and not a manganese battery.</li> <li>→ Replace the dry battery with a new LR6 (size AA) alkaline battery (☞ page 10).</li> <li>→ Charge and discharge the rechargeable battery several times (☞ page 12) <sup>1)</sup>.</li> </ul>
Certain tracks cannot be played.	<ul style="list-style-type: none"> <li>→ You tried to play files saved in a format that is not compatible with this player (☞ page 5).</li> <li>→ Change the setting of "CD-EXTRA" in the OPTION menu. You may play your CD (☞ page 27).</li> </ul>

Symptom	Cause and/or corrective action
"Low Battery" appears on the display, and the CD does not play.	<ul style="list-style-type: none"> <li>→ The rechargeable battery is used up completely. Charge the battery (🔌 page 11).<sup>1)</sup></li> <li>→ Replace the dry battery with a new LR6 (size AA) alkaline battery (🔌 page 10).</li> </ul>
"Hi DC in" appears on the display.	<ul style="list-style-type: none"> <li>→ An AC power adaptor which is rated higher than the one supplied or recommended is being used. Use only the supplied AC power adaptor or the car battery cord recommended in "Optional Accessories" (🔌 page 32).</li> </ul>
The CD does not play, or "No Disc" appears on the display when a CD is placed in the player.	<ul style="list-style-type: none"> <li>→ The CD is dirty or defective. Clean it or change it.</li> <li>→ Check that the CD is inserted with the label side up (🔌 page 14).</li> <li>→ Moisture condensation has occurred. Leave the CD player aside for several hours until the moisture evaporates.</li> <li>→ Close the lid of the battery compartment firmly (🔌 page 10).</li> <li>→ Make sure the battery is inserted correctly (🔌 page 10).</li> <li>→ Connect the AC power adaptor to an AC outlet securely (🔌 page 13).</li> <li>→ Press ▶  /ENTER after one second or more has passed since the AC power adaptor was connected.</li> <li>→ The CD-R/CD-RW in the player is blank.</li> <li>→ There is a problem with the quality of the CD-R/CD-RW, recording device, or application software.</li> </ul>
"HOLD" flashes on the display when you press a button, and the CD does not play.	<ul style="list-style-type: none"> <li>→ The buttons are locked. Slide the HOLD switch back (🔌 page 16).</li> </ul>
Playback starts from the point you stopped (resume function).	<ul style="list-style-type: none"> <li>→ The resume function is working. To start play from the first track, press and hold ▶  /ENTER (▶   on the remote) while the player is stopped until the first track starts playing, or open the lid of the player (🔌 page 15). Or, remove all power sources, and then insert the battery or connect the AC power adaptor again.</li> </ul>
During playback of an ATRAC CD or MP3 CD, the CD does not rotate but you can hear the sound normally.	<ul style="list-style-type: none"> <li>→ This player is designed to stop the rotation of an ATRAC CD or MP3 CD during playback to reduce the power consumption. The player is not malfunctioning.</li> </ul>
"No File" appears on the display after you press ▶  /ENTER or when the lid of the player is closed.	<ul style="list-style-type: none"> <li>→ There are no ATRAC3plus/MP3 files on the CD-R/CD-RW.</li> <li>→ A CD-R/CD-RW from which the data has been erased is being used.</li> <li>→ The CD is dirty.</li> </ul>

Continued ➞

Symptom	Cause and/or corrective action
The LCD display becomes hard to see or slows down.	→ You are using your CD player at high temperatures (above 40°C/104°F) or at low temperatures (below 0°C/32°F). At room temperature, the display will return to its normal operating condition.
Even though you have not selected "BOOKMARK,"  (Bookmark) flashes.	→ If you have selected a playback option other than "BOOKMARK;"  (Bookmark) flashes.
Play stopped abruptly.	<p>→ The off timer has been set. Change the setting of "TIMER" to "OFF" ( page 26).</p> <p>→ The rechargeable battery or the dry battery is used up completely. Charge the rechargeable battery ( page 11) or replace the dry battery with a new LR6 (size AA) alkaline battery ( page 10).</p>
You cannot operate the player, and a sequence of 8 numbers or letters appear on the display of the CD player.	→ This phenomenon may occur, depending on the CD you are using. Remove all power sources, and then insert the battery or reconnect the AC power adaptor. Try to operate the player again. If the problem persists, consult your nearest Sony dealer.

## Others

Symptom	Cause and/or corrective action
When closing the lid of the CD player, the CD starts to rotate.	→ The player is reading the information on the CD, not malfunctioning.
You cannot operate the CD player properly using the remote. <sup>2)</sup>	<p>→ The buttons on the player are kept pressed by mistake.</p> <p>→ The remote is not connected securely.</p>

1) D-NE321 HK4, E18/1 models only. For the area code of the model you purchased, check the upper left side of the bar code on the package.

2) D-NE320 USA/Canadian/European models and D-NE321

## Maintenance

### To clean the casing

Use a soft cloth slightly moistened in water or a mild detergent solution. Do not use alcohol, benzine or thinner.

## Specifications

### System

Compact disc digital audio system

### Laser diode properties

Material: GaAlAs

Wavelength:  $\lambda = 770 - 800$  nm

Emission duration: Continuous

Laser output: Less than 44.6  $\mu$ W

(This output is the value measured at a distance of 200 mm from the objective lens surface on the optical pick-up block with 7 mm aperture.)

### D-A conversion

1-bit quartz time-axis control

### Frequency response

20 - 20 000 Hz  $\pm 1$  dB (measured by JEITA)

### Output (at 3 V input level)

Headphones (stereo minijack)

Approx. 5 mW + Approx. 5 mW at 16  $\Omega$

(Approx. 1.5 mW + Approx. 1.5 mW at 16  $\Omega$ )\*

\*For the customers in Europe

### Power requirements

- LR6 (size AA) battery: 1.5 V DC  $\times$  1
- Sony NH-7WMAA rechargeable battery: 1.2 V DC  $\times$  1\*
- AC power adaptor (DC IN 3 V jack):  
220 V, 50 Hz (Model for China)  
120 V, 60 Hz (Model for Mexico)
- Rated current: 1 A

\* D-NE321 HK4, E18/1 models only. For the area code of the model you purchased, check the upper left side of the bar code on the package.

### Operating temperature

5°C - 35°C (41°F - 95°F)

### Dimensions (w/h/d) (excluding projecting parts and controls)

Approx. 137.8  $\times$  30.9  $\times$  137.8 mm (5  $\frac{1}{2}$   $\times$  1  $\frac{1}{4}$   $\times$  5  $\frac{1}{2}$  in.)

### Mass (excluding accessories)

Approx. 178 g (6.3 oz.)

US and foreign patents licensed from Dolby Laboratories.

Design and specifications are subject to change without notice.

## Optional Accessories

AC power adaptor *	AC-E30HG
Active speaker system	SRS-Z1 SRS-Z30
Car battery cord	DCC-E345
Car battery cord with car connecting pack	DCC-E34CP
Car connecting pack	CPA-9C
Earphones (except for the customers in France)	MDR-EX71SL MDR-G04SL MDR-J20SP
Earphones (for the customers in France)	MDR-E808SP MDR-E808LP



\* Specifications for AC power adaptors vary for each area. Check your local voltage and the shape of the plug before purchasing.

Your dealer may not handle some of the accessories listed above. Please ask the dealer for detailed information about the accessories in your country/region.



# Index

## Symbols

-  (Battery) 11, 12
-  (disc) 14
- 1 20
-  (Timer) 26

## A

- ACTIVE 24
- AC power adaptor 8
- ALL 20
- ATRAC3plus 5
- ATRAC CD 5
- AUTO RANKING 20
- AVLS 26

## B

- Battery carrying case 8
- Battery compartment lid 10, 11
- Battery life 12
- BEEP 26
- BOOKMARK 20, 21

## C

- CD-DA format 5
- CD-Extra 5
- CD-EXTRA 27
- CD-ROM (SonicStage) 8
- CD-TEXT 18
- CD player 9
- CLEARBASS 23, 24
- CUSTOM 24

## D

- Display 10
- Dry battery 10

## E

- Earphones 8
- EQUALIZER 23, 24

## F

- File View 16

## G

- G-PROTECTION 26
- GROUP 20, 21, 27
- Group 6
- GROUP SHUFFLE 20, 21

## H

- HEAVY 24
- HOLD function 16

## I

- ID3 tag 17
- INTRO 20

## L

- LANGUAGE 26
- List View 17

## M

- m3u play list play 21
- MENU 26
- Mix-Mode CD 5
- MP3 CD 5

## O

- OPTION 26
- Optional Accessories 32

## P

- Pause 15
- Play 15
- PLAYLIST 20
- PLAY MODE 19
- PLAY ORDER 27
- POWER SAVE 27
- PROGRAM 20, 22

## R

- RANKING SHUF 20
- Rechargeable battery 8, 11
- Remote 8
- Repeat play 22

## S

- SEAMLESS 26
- Search 15
- SHUFFLE 20
- SOFT 24
- SonicStage 4
- SOUND 24
- Stop 15

## T

- TEXT 26
- TIMER 26
- TRACK 27



**This warranty is only valid in Canada.**

**SONY®**

Network Walkman  
Net MD Walkman  
Hi-MD Walkman

ATRAC CD Player  
ATRAC CD Walkman  
IC Recorder

## LIMITED WARRANTY

Sony of Canada ("Sony") warrants this Product (including any accessories) against defects in material or workmanship as follows:

1. **LABOUR:** For a period of 90 days from the date of purchase, if this Product is determined to be defective, Sony will repair or replace the Product, at its option, at no charge, or pay the labour charges to any Sony authorized service facility. After the Warranty Period, you must pay for all labour charges.

2. **PARTS:** In addition, Sony will supply, at no charge, new or rebuilt replacements in exchange for defective parts for a period of one (1) year. After 90 days from the date of purchase, labour for removal and installation is available from Sony authorized service facilities or a Sony Service Centre at your expense.

You can extend the warranty period for an additional nine months by registering your product ([www.sonymstyle.ca](http://www.sonymstyle.ca)). Once you register your product, the limited warranty period is twelve months from the original date of purchase from Sony or a Sony authorized dealer. The ninety (90) day warranty period is extend-able only to the original purchaser, for an additional period of nine (9) months, for a total of twelve (12) months from the date of purchase when the Product is registered electronically. After the applicable period you must pay for all parts and labour charges.

To obtain warranty service, you must take the Product, or deliver the Product freight prepaid, in either its original packaging or packaging affording an equal degree of protection, to any authorized Sony service facility.

This warranty does not cover customer instruction, installation, set up adjustments or signal reception problems.

This warranty does not cover cosmetic damage or damage due to acts of God, accident, misuse, abuse, negligence, commercial use, or modification of, or to any part of the Product, including the antenna. This warranty does not cover damage due to improper operation or maintenance, connection to improper voltage supply, or attempted repair by anyone other than a facility authorized by Sony to service the Product. This warranty does not cover Products sold AS IS or WITH ALL FAULTS, or consumables (such as fuses or batteries). This warranty is valid only in Canada.

Proof of purchase in the form of a bill of sale or receipted invoice which is evidence that the unit is within the Warranty period must be presented to obtain warranty service.

This warranty is invalid if the factory-applied serial number has been altered or removed from the Product.

**REPAIR OR REPLACEMENT AS PROVIDED UNDER THIS WARRANTY IS THE EXCLUSIVE REMEDY OF THE CONSUMER. SONY SHALL NOT BE LIABLE FOR ANY INCIDENTAL OR CONSEQUENTIAL DAMAGES FOR THE BREACH OF ANY EXPRESS OR IMPLIED WARRANTY ON THIS PRODUCT. EXCEPT TO THE EXTENT PROHIBITED BY APPLICABLE LAW, ANY IMPLIED WARRANTY OF MERCHANTABILITY OR FITNESS FOR A PARTICULAR PURPOSE ON THIS PRODUCT IS LIMITED IN DURATION TO THE DURATION OF THIS WARRANTY.**

Some provinces do not allow the exclusion or limitation of incidental or consequential damages, or allow limitations on how long an implied warranty lasts, so the above limitations or exclusions may not apply to you. This warranty gives you specific legal rights, and you may have other rights which vary from province to province.

For your convenience, Sony of Canada Ltd. has established telephone numbers for frequently asked questions:

To locate the service or dealer nearest you, or for service assistance or resolution of a service problem, or for product information or operation, call:

**Sony Customer Information Center**

1-877-770-7669

or write to:

Sony of Canada Ltd.

115 Gordon Baker Road, Toronto, Ontario M2H 3R6 CANADA

or visit;

[www.sonymstyle.ca/registration](http://www.sonymstyle.ca/registration)

Portable Audio

This information is used to process your warranty registration and for after-sales support purposes. It may also be used by Sony of Canada Ltd. and affiliated Sony companies for customer relationship development and analysis, and to provide you with information and promotional offers on other products and services that may be of interest to you. For a copy of our Privacy Code, please visit our website at [www.sonymstyle.ca/privacy](http://www.sonymstyle.ca/privacy) or call 1-877-899-7669.

D 324511302