

Portable CD Player

Operating Instructions

About the area code

The area code of the location in which you purchased the CD player is shown on upper left of the bar code label on the package.

For accessories supplied with your CD player, check the area code of your model and see "Accessories (supplied/optional)."



"WALKMAN" is a trademark of Sony Corporation.

D-CJ01

WARNING

To prevent fire or shock hazard, do not expose the unit to rain or moisture.

Do not install the appliance in a confined space, such as a bookcase or built-in cabinet.

To prevent fire, do not cover the ventilation of the apparatus with newspapers, tablecloths, curtains, etc. And don't place lighted candles on the apparatus.

To prevent fire or shock hazard, do not place objects filled with liquids, such as vases, on the apparatus.

Certain countries may regulate disposal of the battery used to power this product. Please consult with your local authority.

Table of Contents

Getting started

Locating the controls	4
-----------------------------	---

Playing an audio CD or MP3 files

1. Connect your CD player.	6
2. Insert a CD.	6
3. Play a CD.	6

Playback options

Playing tracks repeatedly (Repeat play)	12
Playing all files in a selected folder (Folder play) (MP3 CD only)	12
Playing a single track (Single play)	12
Playing tracks in random order (Shuffle play)	13
Playing all files in a selected folder in random order (Folder shuffle play) (MP3 CD only)	13
Playing tracks in your favorite order (PGM play)	14

Available features

The G-PROTECTION function	16
Displaying CD text information	16
Checking the time remaining on the CD and the number of tracks left	17
Checking information on a CD with MP3 files	17
Emphasizing the bass sound (SOUND)	18
Protecting your hearing (AVLS)	19
Locking the controls (HOLD)	19
Turning off the operation beep sound	20
Turning off the LCD's backlight	20

Connecting your CD player

Connecting a stereo system	21
----------------------------------	----

Connecting to a power source

Using the rechargeable batteries	22
Using the dry batteries	24
Notes on the power source	24

Additional information

Precautions	25
Maintenance	25
Troubleshooting	26
Specifications	28
Accessories (supplied/optional)	29
About "MP3"	30
About "ID3 tag"	31

Getting started

Locating the controls

For details, see pages in parentheses.

CD player (front)

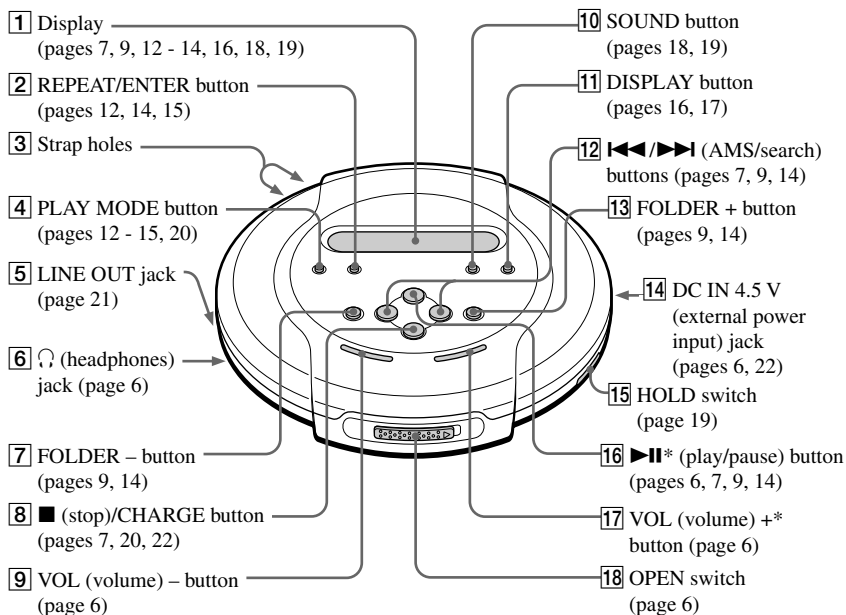

CD player (inside)

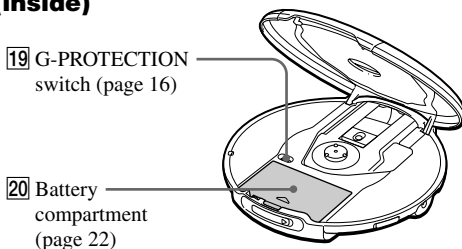

*The button has a tactile dot.

Remote control

- 21 Display
(pages 7, 9, 12 - 14, 16, 18, 19)

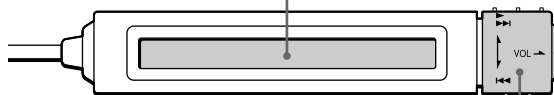

- 23 ■ (stop) button
(pages 7, 20)

- 22 Rotary control
 ►/►►: play, AMS/folder AMS/search (pages 7, 9)
 ◄◄/◄: AMS/folder AMS/search (pages 7, 9)
 VOL +/-: Pull the control in the direction of the arrow, and then turn it toward + or -. (page 7)

- 24 Clip
 28 HOLD switch
(page 19)



- 25 DISPLAY
button
(pages 16, 17)

- 29 Headphone jack
(page 6)

- 26 PLAY MODE
button
(pages 12 - 15, 20)

- 30 || (pause) button
(page 7)

- 27 RPT (repeat)/ENT
(enter) button
(pages 12, 14, 15)

- 31 SOUND button
(page 18)

Note

Use only the supplied remote control. You cannot operate this CD player with the remote control supplied with other CD players.

Playing an audio CD or MP3 files

You can also use rechargeable batteries or dry batteries as a power source.

1. Connect your CD player.

- 1 Connect the AC power adaptor.
- 2 Connect the headphones/earphones.

For models supplied with the remote control

- Connect the plug of the headphones/earphones to the remote control.
- Connect the headphones/earphones to the remote control firmly. A loose connection may cause noise during playback.

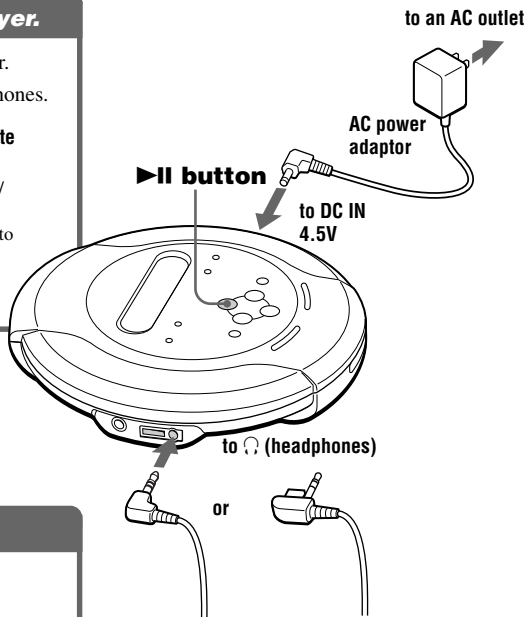

2. Insert a CD.

- 1 Slide OPEN to open the lid.

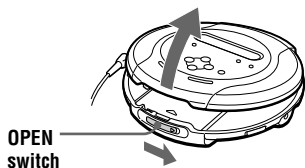

- 2 Place the CD on the tray and close the lid.

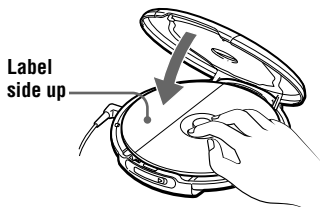

3. Play a CD.

Press ▶||.

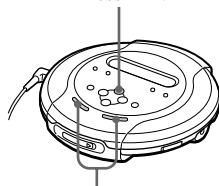

Adjust the volume by pressing VOL + or -.

To	Press
Play (from the point you stopped)	▶▶ (Turn the rotary control on the remote control toward ▶▶/▶▶▶ .) Playback starts from the point you stopped.
Play (from the first track)	▶▶ for 2 seconds or more (Turn the rotary control on the remote control toward ▶▶/▶▶▶ and hold it until the play of the first track starts.)
Pause/resume play after pause	▶▶ (for the remote control)
Stop	■/CHARGE (■ for the remote control)*2
Find the beginning of the current track (AMS*1)	◀◀ once quickly (Turn the rotary control on the remote control toward ◀◀ once.)*2
Find the beginning of previous tracks (AMS)	◀◀ repeatedly (Turn the rotary control on the remote control toward ◀◀ repeatedly.)*2, *3
Find the beginning of the next track (AMS)	▶▶▶ once quickly (Turn the rotary control on the remote control toward ▶▶▶ once.)*2, *3
Find the beginning of succeeding tracks (AMS)	▶▶▶ repeatedly (Turn the rotary control on the remote control toward ▶▶▶ repeatedly.)*2, *3
Go backwards quickly (only when playing an audio CD)	Hold down ◀◀ (Turn the rotary control on the remote control toward ◀◀ and hold it.)*2
Go forward quickly (only when playing an audio CD)	Hold down ▶▶▶ (Turn the rotary control on the remote control toward ▶▶▶ and hold it.)*2

*1 Automatic Music Sensor

*2 These operations can be done during both play and pause.

*3 After you have played the last track, you can return to the beginning of the first track by pressing **▶▶▶**. Similarly, if you are at the first track, you can locate the last track by pressing **◀◀**.

About the display

- When you press **▶▶** (turn the rotary control on the remote control toward **▶▶/▶▶▶**) after changing the CD or turning off and on the player, the total number of tracks in the CD and total playing time appear for about two seconds.
- While a track on the audio CD is playing, the track number and the elapsed playing time of the current track appear.
- While a file on the MP3 CD is playing, the file name and the elapsed playing time of the current file appear.
- When you have paused the track currently playing, the elapsed playing time flashes.

When closing the lid of the CD player with the power supply attached

While the “**W**” flashes in the display, the CD starts rotating and will stop after the CD player reads the disc information. This helps to shorten the waiting time before playback starts.

If the volume level does not increase

- If “AVLS” flashes in the display, hold down SOUND until “AVLS OFF” appears in the display. For details, see “Protecting your hearing (AVLS).”
- If the headphones are connected to the LINE OUT jack, connect them to the  (headphones) jack.

About CD-Rs/CD-RWs and MP3 files

- This CD player can play CD-Rs/CD-RWs recorded in the CD-DA format* and MP3 files recorded in the CD-ROM format, but playback capability may vary depending on the quality of the disc and the condition of the recording device.
 - * CD-DA is the abbreviation for Compact Disc Digital Audio. It is a recording standard used for Audio CDs.
- Finalize the CD-Rs/CD-RWs and MP3 files before use. If you use discs that are not finalized, it will take longer to start playback.

Removing the CD

Remove the CD while pressing the pivot in the center of the tray.

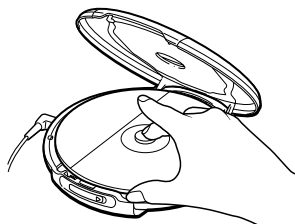

Playing a CD with MP3 files

Prepare the CD player and the CD in the same way as for an audio CD.
(See “About MP3.”)

Press ►II.

The CD player plays all MP3 files on the CD.

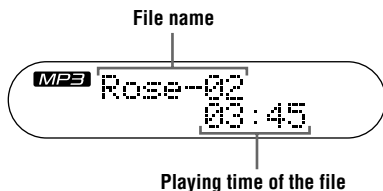

To select a folder on the CD player

Use FOLDER + to go forward and FOLDER – to go backward.

To select a folder on the remote control

1 While a file on the MP3 CD is playing, press DISPLAY.

Folder names are displayed.

2 Turn the rotary control toward ◀◀ or ▶▶/▶▶ to select a folder.

To select a file

Use ▶▶ to go forward and ◀◀ to go backward.

Notes

- Before playing a file, the CD player reads all file and folder information on the CD. “READING” is displayed.
- You can use the buttons mentioned in the table on page 7 for additional operations in the same way as when playing an audio CD.

Example of folder structure and playing order

The playing order of folders and files is as follows:

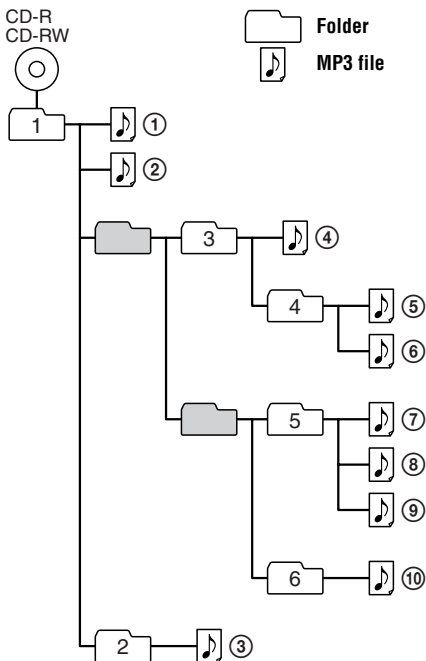

File mode	Plays all MP3 files from ①, ②, ③...⑨, ⑩
Folder mode	Plays all MP3 files in the selected folder. (Example: If you select folder 3, the CD player plays file ④. If you select folder 4, the CD player plays file ⑤ and ⑥.)

Notes

- A folder that does not include an MP3 file is skipped.
- Maximum number of folders: 255
Maximum number of files: 255
- Folder names and file names can be displayed with up to 64 characters. (Joliet extensions)
- The characters A - Z, 0 - 9, and _ can be displayed on this CD player.
- When referring to MP3 CDs, “folder” is equivalent to an “album” and “file” is equivalent to a “track.”

Playback options

You can enjoy various playback options using PLAY MODE and REPEAT/ENTER.

PLAY MODE button

Each time you press the button, you can change the playback mode.

No indication
(Normal play)

“”*

(Play all files in a selected folder)

“1”

(Play a single track)

“SHUF”

(Play tracks in random order)

“ SHUF”*

(Play files in a selected folder in random order)

“PGM”

(Play tracks in your favorite order)

* You can select this mode only when playing MP3 files.

REPEAT/ENTER button

REPEAT

You can repeat play mode that was selected using PLAY MODE.

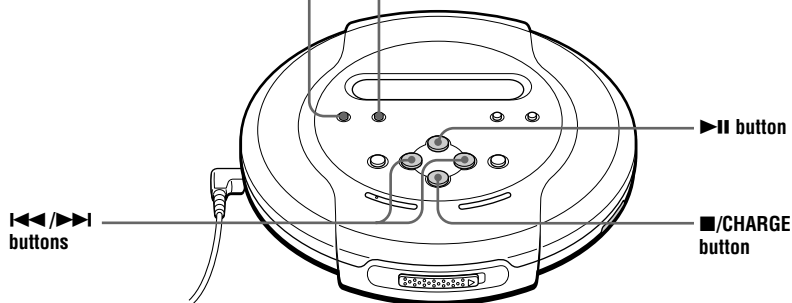

ENTER

You can select tracks for PGM play mode.



(Continued)

Playing tracks repeatedly (Repeat play)

You can play tracks (“files” when playing an MP3 CD) repeatedly in normal,  (MP3 CD only), single, shuffle,  shuffle (MP3 CD only) and PGM play modes.

During playback, press REPEAT/ENTER.

Audio CD



Track number

Playing time

MP3 CD



Playing time

When playing MP3 files

- In normal mode, the CD player plays all files (up to 255 files) on a CD repeatedly.
- In folder mode, the CD player plays all files (up to 255 files) in the selected folder repeatedly.

Playing all files in a selected folder (Folder play) (MP3 CD only)

During playback, press PLAY MODE repeatedly until  appears.

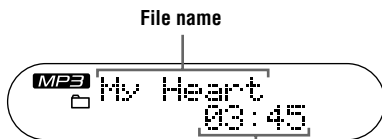

Playing time

Playing a single track (Single play)

During playback, press PLAY MODE repeatedly until “1” appears.

Audio CD



Track number

Playing time

MP3 CD



Playing time

Playing tracks in random order (Shuffle play)

During playback, press PLAY MODE repeatedly until “SHUF” appears.

Audio CD

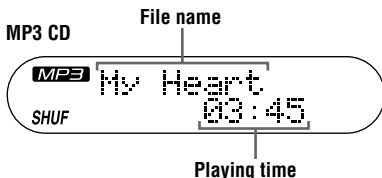
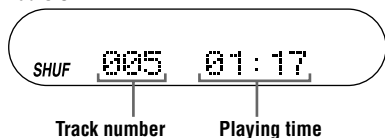

When playing MP3 files

In shuffle mode, the CD player plays all files (up to 255 files) on a CD in random order.

Playing all files in a selected folder in random order (Folder shuffle play) (MP3 CD only)

During playback, press PLAY MODE repeatedly until “ SHUF” appears.

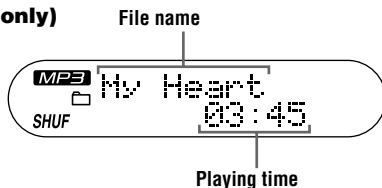

When playing MP3 files

In folder shuffle mode, the CD player plays all files (up to 255 files) in a selected folder in random order.

Playing tracks in your favorite order (PGM play)

You can program the CD player to play up to 32 tracks (“files” when playing an MP3 CD) in your favorite order.

1 During playback, press PLAY MODE repeatedly until “PGM” appears.

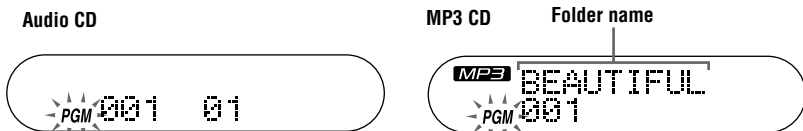

2 Press I◀◀ or ▶▶I to select a track.

When playing an MP3 CD, you can also select a folder using FOLDER + or -. (During PGM play, you cannot select a folder using the remote control.)

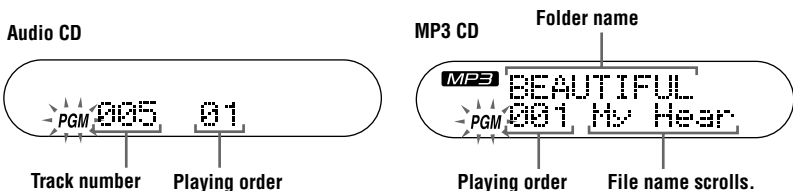

3 Press REPEAT/ENTER quickly to enter the selected track.

“000” appears (audio CD only) and the playing order increases by one.

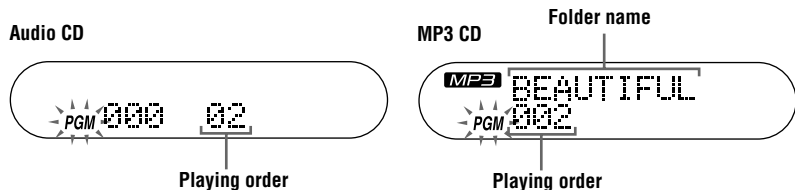

4 Repeat steps 2 and 3 to select the tracks in your favorite order.

5 Press ▶II, or hold down REPEAT/ENTER until play starts.

To check the program

During programming:

Press REPEAT/ENTER repeatedly before step 5.

During the PGM play:

Press PLAY MODE repeatedly until "PGM" flashes, then press REPEAT/ENTER. Each time you press REPEAT/ENTER, the track number appears.

Notes

- When you finish entering the 32nd track in step 3, the first track selected appears in the display.
- If you select more than 32 tracks, the first tracks selected are erased.

When playing MP3 files

In PGM mode, you can program up to 32 files the same as you would for audio CD tracks.

The G-PROTECTION function

The G-PROTECTION function has been developed to provide excellent protection against sound skipping while jogging. When you set the G-PROTECTION switch on your CD player to "2", the G-PROTECTION function will be enhanced compared to "1."

To walk with the CD player and enjoy high quality CD sound using the G-PROTECTION function, set the G-PROTECTION switch to "1." While taking harder exercise, it is recommended that you set it to "2."

Set G-PROTECTION (under the lid) to "1" or "2."



Note

Sound may skip:

- if the CD player receives stronger continuous shock than expected,
- if a dirty or scratched CD is played or
- when using poor-quality CD-Rs/CD-RWs or if there is a problem with the original recording device or application software.

Displaying CD text information

When you play an audio CD containing CD text information, the track name, disc name, artist name, etc., appear in the display.

Display on the CD player

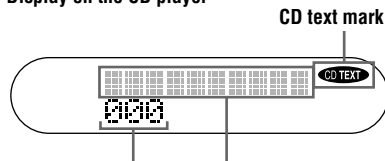

The "track number" CD text appears in this portion.*

* While the CD player is reading the information on the CD, "READING" appears.

Press DISPLAY.

Each time you press the button, the display changes as follows:

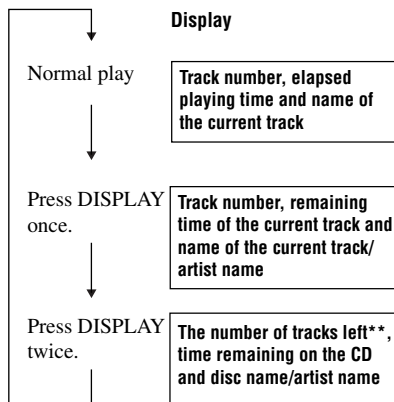

** Not displayed during Single play, Shuffle play or PGM play.

Note

CD text displayed on this CD player is in English only.

Checking the time remaining on the CD and the number of tracks left

You can check the remaining time on the audio CD and the number of tracks left using DISPLAY.

When playing an audio CD containing CD text information, the following information cannot be displayed on the remote control.

Press DISPLAY.

Each time you press the button, the display changes as follows.

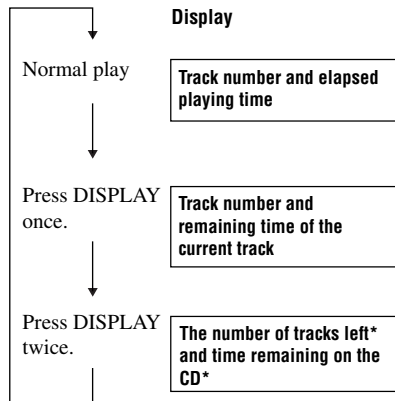

* Not displayed during Single play, Shuffle play or PGM play.

Checking information on a CD with MP3 files

You can check information on a CD with MP3 files using DISPLAY.

You can also check ID3 tag (Version 1.1) information if the file has that information stored. (See "About ID3 tag.")

Press DISPLAY.

Each time you press the button, the display changes as follows.

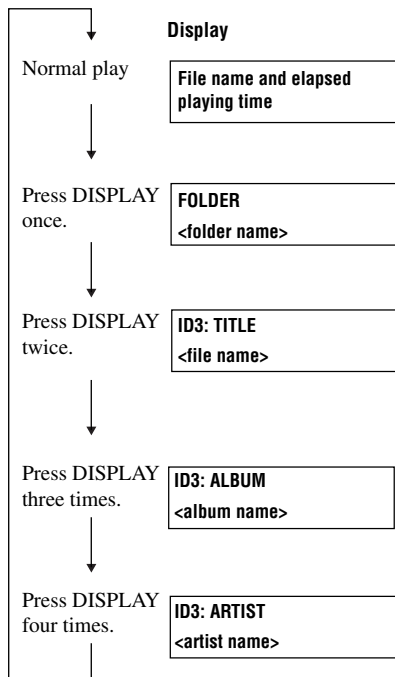

(Continued)

Checking information on a CD with MP3 files

Notes

- If the folder does not have a folder name, “ROOT” appears in the display.
- If the file does not have ID3 tag information, “- - - -” appears in the display.

Emphasizing the bass sound (SOUND)

You can emphasize the bass-boosted sound.

Press **SOUND** to select “**BASS 1**” or “**BASS 2**.”

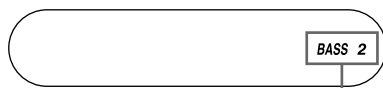
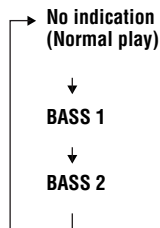

The selected sound mode is displayed.

“BASS 2” enhances the bass sound more than “BASS 1.”

Note

If the sound is distorted when using the SOUND function, turn down the volume.

Protecting your hearing

(AVLS)

The AVLS (Automatic Volume Limiter System) function keeps down the maximum volume to protect your hearing.

Hold down **SOUND** on the CD player until “AVLS ON” appears in the display.

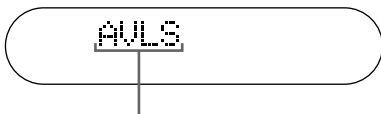

Flashes when the volume is turned up beyond a certain level.

When you turn up the volume to “VOL■■■■”

“AVLS” flashes and you cannot turn up the volume any more. If you want to turn up the volume to more than “VOL■■■■,” hold down **SOUND** until “AVLS OFF” appears in the display.

Notes

- You can activate the AVLS function using **SOUND** on the CD player only.
- If you use the **SOUND** function and the AVLS function at the same time, sound may be distorted. If this happens, turn down the volume.

Locking the controls

(HOLD)

You can lock the controls on your CD player to prevent accidental button presses.

Slide **HOLD** in the direction of the arrow.

HOLD 

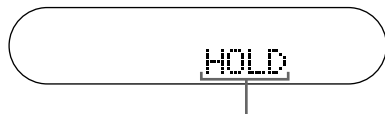

Displayed when the HOLD function is activated.

You can use the HOLD function with both the CD player and remote control. You can still operate your CD player using the remote control when HOLD on the remote control is set to off.

To unlock the controls

Slide **HOLD** in the opposite direction of the arrow.

Note

Even if the HOLD function is working, “HOLD” will not appear in the display of the remote control.

Turning off the operation beep sound

You can turn off the beep sound that is heard from your headphones/earphones when you operate your CD player.

- 1 Remove the power source (AC power adaptor, rechargeable batteries or dry batteries) from the CD player.**
- 2 Connect the power source while pressing **■**/CHARGE on the CD player or **■** on the remote control for about one second or more.**

To turn on the beep sound

Remove the power source and then connect the power source without pressing **■**/CHARGE or **■**.

Turning off the LCD's backlight

While you are using the rechargeable batteries or dry batteries, the LCD's backlight turns on for about 5 seconds every time you press a button. However, you can turn off the backlight to save the battery power.

- 1 Remove the rechargeable batteries or dry batteries from the CD player.**
- 2 Insert the batteries while pressing PLAY MODE.**

To turn on the LCD's backlight

Remove the batteries and then insert the batteries without pressing PLAY MODE.

About the LCD's backlight

The LCD's backlight is always turned on when using the AC power adaptor.

► Connecting your CD player

Connecting a stereo system

You can listen to CDs through a stereo system and record CDs on a cassette tape. For details, see the instruction manual that comes with the connected device.

Be sure to turn off all connected devices before making connections.

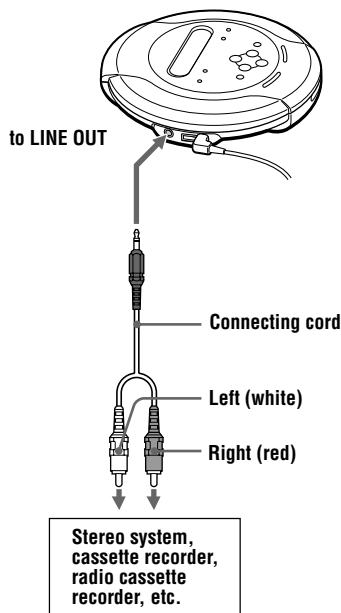

Notes

- Before you play a CD, turn down the volume of the connected device to avoid damaging the connected speakers.
- Use the AC power adaptor for recording. If you use the rechargeable batteries or dry batteries as a power source, batteries may become completely depleted during recording.
- Adjust the volume properly on the connected device so that the sound will not be distorted.

When using the connecting cord

If the sound is distorted, connect the device to the  jack.

About the G-PROTECTION and SOUND functions when using the connecting cord

- To record high quality CD sound, set the G-PROTECTION switch to "1."
- The SOUND function works only on the output sound from the  jack and not work on the output sound from the LINE OUT jack.

▶ Connecting to a power source

You can use the following power sources:

- Rechargeable batteries
- AC power adaptor (see “Playing an audio CD or MP3 files”)
- LR6 (size AA) alkaline batteries

For the battery life and charging time of the rechargeable batteries, see “Specifications.”

Using the rechargeable batteries

Charge the rechargeable batteries before using them for the first time. You can use only the following rechargeable batteries for your CD player.

- NC-WMAA
- NH-WM2AA

- 1** Open the battery compartment lid inside your CD player.

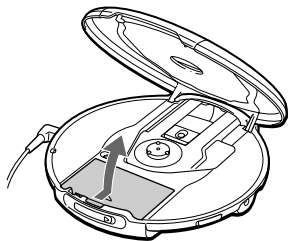

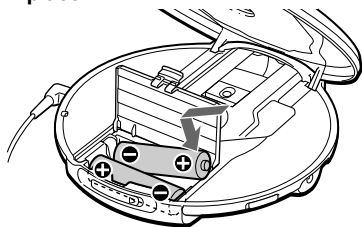

- 2** Insert two rechargeable batteries by matching the ⊕ to the diagram in the battery compartment and close the lid until it clicks into place.

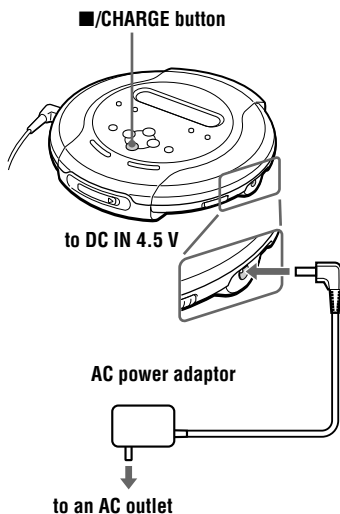

- 3** Connect the AC power adaptor to the DC IN 4.5 V jack of your CD player and an AC outlet, then press ■/CHARGE to start charging.



The CD player charges the batteries. The “Charging” indicator turns on in the display, and the indicator sections of  light up in succession. When the batteries are completely charged, the “Charging” and  indicators turn off. If you press ■/CHARGE after the charge has already been completed, the  indicator flashes and “FULL” appears in the display.

- 4** Disconnect the AC power adaptor.

To remove the rechargeable batteries

Remove the batteries as illustrated below.

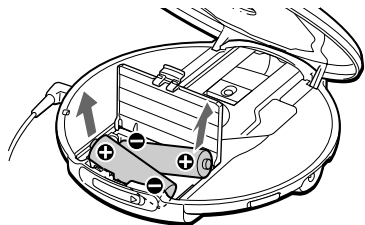

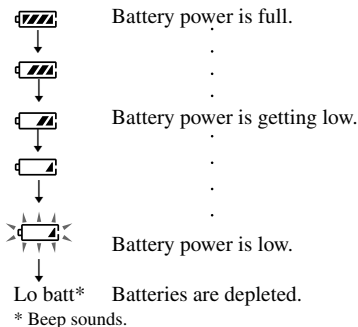

When to charge the rechargeable batteries

You can check the remaining power of the batteries in the display.



To keep the original battery capacity for a long time, charge the batteries only when they are completely depleted.

Notes

- The indicator sections of  roughly shows the remaining battery power. One section does not always indicate one-fourth of the battery power.
- Depending on operating conditions, the indicator sections of  may increase or decrease.

When to replace the rechargeable batteries

If the battery life becomes shorter by about half, replace the batteries with new rechargeable batteries.

Note on the rechargeable batteries

If the battery is new or has not been used for a long time, it may not be charged completely until you charge and discharge it several times.

Note on carrying the rechargeable batteries

Use the supplied battery carrying case to prevent unexpected heat. If the rechargeable batteries and the metallic objects are contacted, heat or fire may occur due to a short circuit.

To attach the battery compartment lid

If the battery compartment lid is detached by an accidental drop, excessive force, etc., attach it as illustrated below.

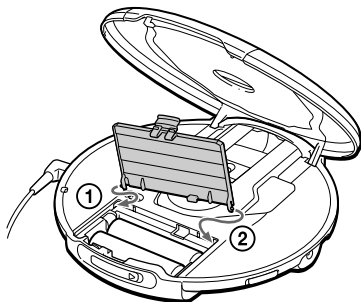

Using the dry batteries

Use only the following dry battery type for your CD player:

- LR6 (size AA) alkaline batteries

Note

Be sure to remove the AC power adaptor when using the dry batteries.

1 Open the battery compartment lid.

2 Insert two LR6 (size AA) batteries by matching the \oplus to the diagram in the battery compartment.

To remove the batteries

Remove the batteries in the same way as rechargeable batteries.

When to replace the batteries

You can check the remaining power of the batteries in the display.

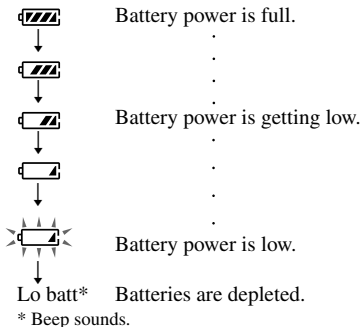

When the batteries are depleted, replace both batteries with new ones.

Notes on the power source

Disconnect all power sources when the CD player is not used.

On AC power adaptor

- Use only the AC power adaptor supplied or recommended in "Accessories (supplied/optional)." Do not use any other AC power adaptor. It may cause a malfunction.

Polarity of the plug



- When disconnecting the AC power adaptor from the AC outlet, grasp the adaptor itself. Do not pull it by the cord.
- Do not touch the AC power adaptor with wet hands.

On rechargeable batteries and dry batteries

- Do not charge the dry batteries.
- Do not throw the batteries into fire.
- Do not carry the batteries with coins or other metallic objects. It can generate heat if the positive and negative terminals of the battery are accidentally contacted by a metallic object.
- Do not mix rechargeable batteries with dry batteries.
- Do not mix new batteries with old ones.
- Do not use different types of batteries together.
- When the batteries are not to be used for a long time, remove them.
- If battery leakage occurs, wipe off any deposit in the battery compartment, and install new batteries. In case the deposit adheres to you, wash it off thoroughly.

► Additional information

Precautions

On safety

- Should any solid objects or liquid fall into the CD player, unplug it and have it checked by qualified personnel before operating it any further.
- Do not put any foreign objects in the DC IN 4.5 V (external power input) jack.

On the CD player

- Keep the lens on the CD player clean and do not touch it. If you do so, the lens may be damaged and the CD player will not operate properly.
- Do not put any heavy object on top of the CD player. The CD player and the CD may be damaged.
- Do not leave the CD player in a location near heat sources, or in a place subject to direct sunlight, excessive dust or sand, moisture, rain, mechanical shock, unlevelled surface, or in a car with its windows closed.
- If the CD player causes interference to the radio or television reception, turn off the CD player or move it away from the radio or television.
- Discs with non-standard shapes (e.g., heart, square, star) cannot be played on this CD player. Attempting to do so may damage the CD player. Do not use such discs.

On handling CDs

- To keep the CD clean, handle it by its edge. Do not touch the surface.
- Do not stick paper or tape onto the CD.

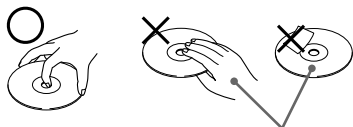

Not these ways

- Do not expose the CD to direct sunlight or heat sources such as hot air ducts. Do not leave the CD in a car parked under direct sunlight.

On headphones/earphones

Road safety

Do not use headphones/earphones while driving, cycling, or operating any motorized vehicle. It may create a traffic hazard and is illegal in some areas. It can also be potentially dangerous to play your headsets at high volume while walking, especially at pedestrian crossings. You should exercise extreme caution or discontinue use in potentially hazardous situations.

Preventing hearing damage

Avoid using headphones/earphones at high volume. Hearing experts advise against continuous, loud and extended play. If you experience a ringing in your ears, reduce volume or discontinue use.

Consideration for others

Keep the volume at a moderate level. This will allow you to hear outside sounds and to be considerate to the people around you.



Maintenance

To clean the casing

Use a soft cloth slightly moistened in water or a mild detergent solution. Do not use alcohol, benzine or thinner.

Troubleshooting

Should any problem persist after you have checked these symptoms, consult your nearest Sony dealer.

Symptom	Cause and/or corrective actions
Cannot adjust the volume by turning the rotary control on the remote control.	→ Pull the rotary control in the direction of the arrow indicated on the control, then turn the control toward VOL + or -.
Cannot start play by turning the rotary control on the remote control.	→ The rotary control is pulled out. Push the control back, then turn the control toward ►/►►.
The volume does not increase even if you press the VOL + button repeatedly.	→ The headphones/earphones are connected to the LINE OUT jack. Connect them to the  (headphones) jack. (page 6)
Cannot adjust the volume.	→ The headphones/earphones are connected to the LINE OUT jack. Connect them to the  (headphones) jack. (page 6)
No sound, or noise is heard.	→ Connect the plugs firmly. (page 6) → Plugs are dirty. Clean the plugs with a dry soft cloth periodically. → When playing a CD containing both MP3 files and files recorded in a format other than MP3, you selected the latter file type. This CD player can play tracks recorded in the CD-DA format or MP3 files recorded in the CD-ROM format only. (page 8)
The playing time is too short when powered with the dry batteries.	→ Check that you are using alkaline batteries and not manganese batteries. (page 24) → Replace the batteries with new LR6 (size AA) alkaline batteries. (page 24)
The playing time is too short when powered with the rechargeable batteries.	→ Charge and discharge the rechargeable batteries several times. (pages 22, 23)
“Lo batt” or “000” appears in the display. The CD does not play.	→ The rechargeable batteries are used up completely. Charge the batteries. (page 22) → Replace the batteries with new LR6 (size AA) alkaline batteries. (page 24)
“Hi dc In” appears in the display.	→ Use only the AC power adaptor or car battery cord in “Accessories (supplied/optional).” (page 29) → Remove all power sources, then insert the batteries or connect the AC power adaptor again. (pages 6, 22 - 24)
The CD does not play or “No disc” appears in the display when a CD is placed in the CD player.	→ The buttons are locked. Slide the HOLD switch back. (page 19) → The CD is dirty or defective. (page 25) → Check that the CD is inserted with the label side up. (page 6) → Moisture condensation has occurred. Leave the CD player aside for several hours until the moisture evaporates. → Close the lid of the battery compartment firmly. (page 22) → Make sure the batteries are inserted correctly. (pages 22 - 24) → Connect the AC power adaptor to an AC outlet securely. (page 6) → Press ► after one second or more has passed since the AC power adaptor was connected. → The CD-R/CD-RW is blank. → There is a problem with the quality of the CD-R/CD-RW, recording device, or application software. (page 8)

Symptom	Cause and/or corrective action
“HOLD” appears in the display when you press a button, and the CD does not play.	→ The buttons are locked. Slide the HOLD switch back. (page 19)
The CD player does not start charging.	→ While the CD player is stopped, press ■/CHARGE. (page 22)
Playback starts from the point you stopped. (resume function)	→ The resume function is working. To start play from the first track, press ► for 2 seconds or more, or open the lid of the CD player. Or remove all power sources, then insert the batteries or connect the AC power adaptor again. (pages 6, 7, 22, 24)
Rustling noise is heard from the CD.	→ Close the lid of the battery compartment firmly. (page 22)
During playback of an MP3 CD, the CD does not rotate but you can hear the sound normally.	→ The CD player is designed to stop the rotation of an MP3 CD during playback to reduce the power consumption. The player is not malfunctioning.
“NO FILE” appears in the display after ► is pressed or the lid of the CD player is closed.	<ul style="list-style-type: none"> → There are no MP3 files in the CD. → A CD-RW from which the data has been erased is being used. → The CD is dirty.
The CD does not start playing. It takes a long time to start playback.	→ Finalize the CD. (page 8)
When closing the lid of the CD player, the CD starts to rotate.	→ The CD player is reading the information on the CD. The player is not malfunctioning.
You cannot operate the CD player properly using the remote control.	→ The buttons on the CD player are kept pressed by mistake.

Specifications

System

Compact disc digital audio system

Laser diode properties

Material: GaAlAs

Wavelength: $\lambda = 780 \text{ nm}$

Emission duration: Continuous

Laser output: Less than $44.6 \mu\text{W}$

(This output is the value measured at a distance of 200 mm from the objective lens surface on the optical pick-up block with 7 mm aperture.)

D-A conversion

1-bit quartz time-axis control

Frequency response

20 - 20 000 Hz -1 dB (measured by JEITA CP-307)

Output (at 4.5 V input level)

Line output (stereo minijack)

Output level 0.7 V rms at 47 k Ω

Recommended load impedance over 10 k Ω

Headphones (stereo minijack)

Approx. 5 mW + Approx. 5 mW at 16 Ω

Power requirements

For the area code of the model you purchased, check the upper left side of the bar code on the package.

- Two Sony NC-WMAA rechargeable batteries: 2.4 V DC
- Sony NH-WM2AA rechargeable batteries: 2.4 V DC
- Two LR6 (size AA) batteries: 3 V DC
- AC power adaptor (DC IN 4.5 V jack):
U/U2/CA2/E92/MX2/TW2/BR3 model:
120 V, 60 Hz
CED/CET/CEW/CEX/CE7/EE/EE1/E13/G5/
G6/G7/G8/BR1 model:
220 - 230 V, 50/60 Hz
CEK/3CE7 model: 230 - 240 V, 50 Hz
AU2 model: 240 V, 50 Hz
JE.W/E33/EA3/KR4 model: 100 - 240 V, 50/
60 Hz
HK2 model: 220 V, 50/60 Hz
AR1/CN2 model: 220 V, 50 Hz

Battery life* (approx. hours)

(When you use the CD player on a flat and stable surface.)

Playing time varies depending on how the CD player is used.

Figures in brackets show the playing time of MP3 files.

When using	G-PROTECTION function	
	"1"	"2"
Two NC-WMAA (charged for about 3 hours**)	10.5 [8]	10.5 [8]
NH-WM2AA (charged for about 5 hours**)	22.5 [18]	23 [18]
Two Sony alkaline batteries LR6(SG) (produced in Japan)	31.5 [24]	32 [24]

* Measured value by the standard of JEITA (Japan Electronics and Information Technology Industries Association).

** Charging time varies depending on how the rechargeable battery is used.

Operating temperature

5°C - 35°C (41°F - 95°F)

Dimensions (w/h/d) (excluding projecting parts and controls)

Approx. 132.0 × 29.9 × 137.5 mm

Mass (excluding accessories)

Approx. 218 g

Design and specifications are subject to change without notice.

Accessories (supplied/optional)

Supplied accessories

For the area code of the location in which you purchased the CD player, check the upper left side of the bar code on the package.

- AC power adaptor (1)
- Headphones/earphones with remote control (1)
- Rechargeable batteries (2)
- Battery carrying case (2)
- Carrying pouch (1)

Optional accessories

AC power adaptor	AC-E45HG
Active speaker system	SRS-Z1 SRS-Z1000
Car battery cord	DCC-E345
Car battery cord with car connecting pack	DCC-E34CP
Car connecting pack	CPA-9C
Connecting cord	RK-G129 RK-G136
Rechargeable battery	NH-WM2AA
Earphones	MDR-E848LP MDR-EX70LP
Headphones	MDR-A44L MDR-A110LP

When connecting optional headphones/earphones to the supplied remote control

Use only headphones with stereo mini plugs. You cannot use headphones with micro plugs.

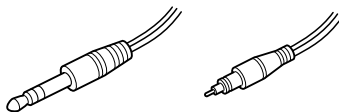

Stereo miniplug

Micro plug

Your dealer may not handle some of the accessories listed above. Please ask the dealer for detailed information about the accessories in your country.

About “MP3”

What is the MP3?

MP3 (MPEG 1 Audio Layer-3) is a standard technology and format for compressing a sound sequence. The file is compressed to about 1/10 of its original size. Sounds outside the range of human hearing are compressed while the sounds we can hear are not compressed.

Playable “MP3” files on this player

You can only play MP3 files recorded by following requirements.

USABLE MEDIA

CD-Rs and CD-RWs

USABLE DISC FORMAT

You can use ISO 9660 Level 1/2 and Joliet extension format discs. This unit can display only 1-byte characters. (2-byte characters like those of Japanese are displayed as “-.”)

The major specification of the usable disc format is:

- Maximum directory steps: 8
- Usable characters for a file/folder name: A - Z, 0 - 9, _ (underscore)
- Maximum number of characters for a file name: 64 and a 3-character extension code

Notes

- When naming, be sure to add the file extension “mp3” to the file name.
- If you put the extension “mp3” to a file other than an MP3 file, the player cannot recognize the file properly and will generate random noise that could damage your speakers.
- The file name does not correspond to the ID tag.

THE USABLE NUMBER OF FOLDERS/FILES

- Maximum folder number: 255
- Maximum file number: 255

SETTINGS FOR COMPRESSION SOFTWARE AND WRITING SOFTWARE

- To compress a source for an MP3 file, we recommend setting the transfer bit rate of the compression software to “44.1 kHz”, “128kbps”, and “Constant Bit Rate”.
- To record up to the maximum capacity, set to the “halting of writing”.
- To record at one time up to the maximum capacity on media that has nothing recorded it, set to “Disc at Once”.

NOTES FOR SAVING FILES ON THE MEDIA

When the disc is inserted, the player reads all the files on that disc. If there are many folders or non-MP3 files on the disc, it may take a long time for play to begin or for the next MP3 file to start play.

Do not save unnecessary folders or files other than MP3 ones in the disc to be used for MP3 listening.

We recommend that you do not save other types files or unnecessary folders on a disc that has MP3 files.

About “ID3 tag”

ID3 tag is a format for adding certain information (track name, album name, artist name, etc.) to MP3 files.

Note

This CD player conforms to Version 1.1 of the ID3 tag format. If you use a version other than 1.1, ID3 tag information will not be displayed correctly.

<http://www.sony.net/>

Sony Corporation